

Power relays (Over 2 A)
PA-N RELAYS

Product Catalog

**IN Your
Future**

PA-N RELAYS

Complies with IEC61010 reinforced insulation, For PLC/Interface, 1 Form A 5 A, Slim power relay

Protective construction: Sealed type (RTIII)

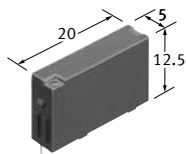

(Unit: mm)

FEATURES

- **High density mounting:**
width (5 mm) x length (20 mm) x height (12.5 mm)
- **Complies with IEC61010 reinforced insulation standards**
- **Insulation distance (Between contact and coil)**
Clearance: Min. 5.29 mm, Creepage: Min. 5.35 mm
- **Dielectric strength: 3,000 Vrms**
Surge withstand voltage: 6,000 V
- **Low operating power: 110 mW**
- **Complies with Standard for Hazardous Location (ANSI/ISA 12.12.01)**

TYPICAL APPLICATIONS

- Industrial equipment, office equipment
- Measuring devices and test equipment
- Output relays for programmable controllers and temperature controllers

ORDERING INFORMATION (PART NO.)

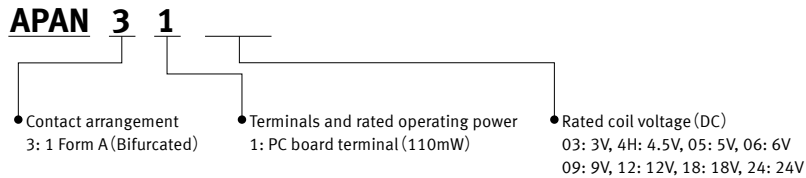

TYPES

Contact arrangement	Rated coil voltage	Part No.	Standard packing	
			Inner carton (1-tube)	Case
1 Form A	3 V DC	APAN3103	25 pcs.	1,000 pcs.
	4.5 V DC	APAN314H		
	5 V DC	APAN3105		
	6 V DC	APAN3106		
	9 V DC	APAN3109		
	12 V DC	APAN3112		
	18 V DC	APAN3118		
	24 V DC	APAN3124		

For the sockets, please refer to the "PA-N RELAYS PC board socket/Self-clinching terminal socket".

Power relays (Over 2 A) PA-N RELAYS

RATING

Coil data

- Operating characteristics such as 'Operate voltage' and 'Release voltage' are influenced by mounting conditions, ambient temperature, etc.
Therefore, please use the relay within $\pm 5\%$ of rated coil voltage.
- 'Initial' means the condition of products at the time of delivery.

Rated coil voltage	Operate voltage* (at 20°C)	Release voltage* (at 20°C)	Rated operating current ($\pm 10\%$, at 20°C)	Coil resistance ($\pm 10\%$, at 20°C)	Rated operating power	Max. allowable voltage (at 20°C)
3 V DC	Max. 70% V of rated coil voltage (Initial)	Min. 5% V of rated coil voltage (Initial)	36.7 mA	82 Ω	110 mW	120% V of rated coil voltage
4.5 V DC			24.4 mA	184 Ω		
5 V DC			22 mA	227 Ω		
6 V DC			18.3 mA	327 Ω		
9 V DC			12.2 mA	736 Ω		
12 V DC			9.2 mA	1,309 Ω		
18 V DC			6.1 mA	2,945 Ω		
24 V DC			4.6 mA	5,236 Ω		

*square, pulse drive

Specifications

Item	Specifications	
Contact data	Contact arrangement	1 Form A (Bifurcated)
	Contact resistance (initial)	Max. 30 m Ω (by voltage drop 6 V DC 1 A)
	Contact material	AgNi type + Au
	Contact rating (resistive)	5 A 250 V AC, 5 A 30 V DC
	Max. switching power (resistive)	1,250 VA, 150 W
	Max. switching voltage	250 V AC, 110 V DC (0.4 A)
	Max. switching current	5 A (AC, DC)
	Min. switching load (reference value)*1	100 μ A 100 mV DC
Insulation resistance (initial)	Min. 1,000 M Ω (at 500 V DC, Measured portion is the same as the case of dielectric strength.)	
Dielectric strength (initial)	Between open contacts	1,000 Vrms for 1 min (detection current: 10 mA)
	Between contact and coil	3,000 Vrms for 1 min (detection current: 10 mA)
Surge withstand voltage (initial)*2	Between contact and coil	6,000 V
Time characteristics (initial)	Operate time	Max. 10 ms at rated coil voltage (at 20°C, without bounce)
	Release time	Max. 5 ms at rated coil voltage (at 20°C, without bounce, without diode)
Shock resistance	Functional	147 m/s ² (half-sine shock pulse: 11 ms, detection time: 10 μ s)
	Destructive	980 m/s ² (half-sine shock pulse: 6 ms)
Vibration resistance	Functional	10 to 55 Hz (at double amplitude of 2.5 mm, detection time: 10 μ s)
	Destructive	10 to 55 Hz (at double amplitude of 3.5 mm)
Expected life	Mechanical life	Min. 20 x 10 ⁶ ope. (switching frequency: at 180 times/min)
Conditions	Conditions for usage, transport and storage*3	Ambient temperature: -40 to +90°C (-40 to +60°C at our standard packing condition) Humidity: 5 to 85% RH (Avoid icing and condensation)
Unit weight		Approx. 3 g

*1. This value can change due to the switching frequency, environmental conditions, and desired reliability level, therefore it is recommended to check this with the actual load.

*2. Wave is standard shock voltage of $\pm 1.2 \times 50 \mu$ s according to JEC-212-1981.

*3. For ambient temperature, please read "GUIDELINES FOR RELAY USAGE".

Expected electrical life

Type	Load	Switching capacity	Number of operations
1 Form A	Resistive load	3 A 250 V AC	Min. 100 x 10 ³ ope. (Switching frequency at 20 times/min)
		3 A 30 V DC	Min. 100 x 10 ³ ope. (Switching frequency at 20 times/min)
		5 A 250 V AC	Min. 50 x 10 ³ ope. (Switching frequency at 6 times/min, ON : OFF = 1 s : 9 s)
		5 A 30 V DC	Min. 50 x 10 ³ ope. (Switching frequency at 20 times/min)
	Inductive load	2 A 250 V AC (cos ϕ =0.4)	Min. 100 x 10 ³ ope. (Switching frequency at 6 times/min, ON : OFF = 1 s : 9 s)

REFERENCE DATA

1. Max. switching capacity

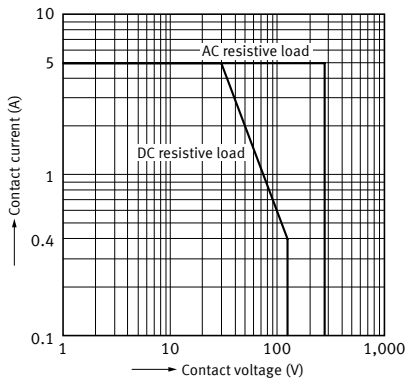

2. Switching life curve

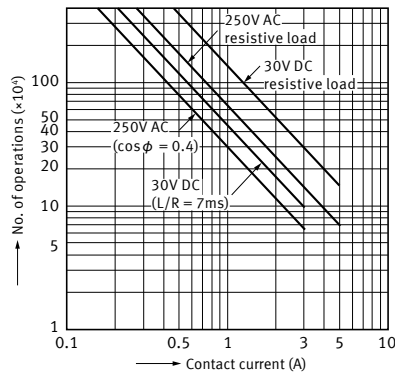

3. Coil temperature characteristics (Average)

Tested sample: APAN3124, 6 pcs.
Measured portion: Inside the coil
Ambient temperature: 20°C, 90°C (No contact current)

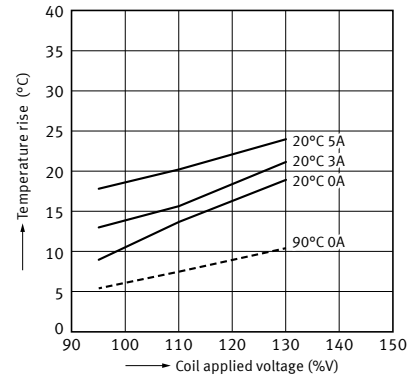

4. Ambient temperature characteristics (Average)

Tested sample: APAN3124, 6 pcs.

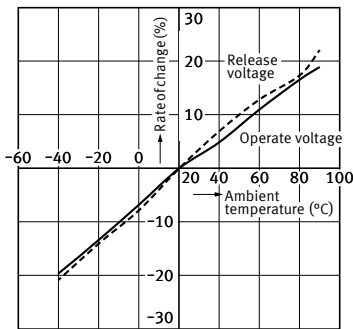

5. Operate and release time

Tested sample: APAN3124, 20 pcs.
Measured direction: Upright

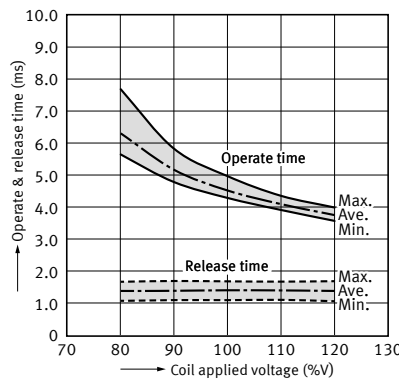

6. Shock resistance

Tested sample: APAN3124, 6 pcs.

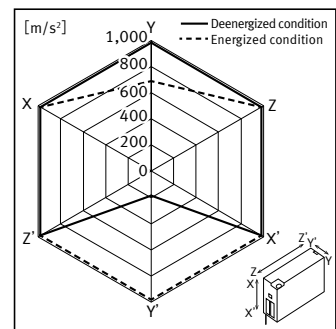

DIMENSIONS

CAD The CAD data of the products with a "CAD" mark can be downloaded from our Website.

Unit: mm

CAD



External dimensions

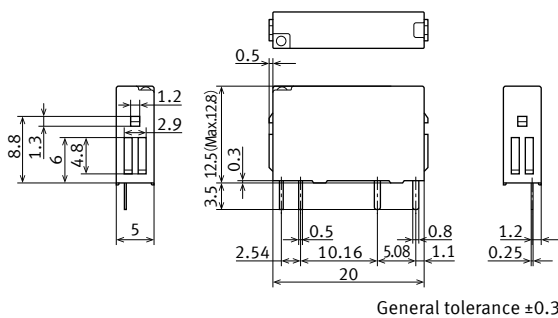

Recommended PC board pattern

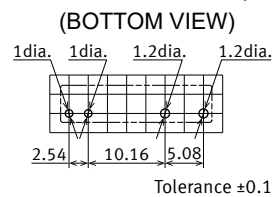

Schematic (BOTTOM VIEW)

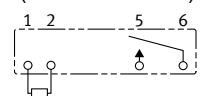

Power relays (Over 2 A) PA-N RELAYS

SAFETY STANDARDS

Each standard may be updated at any time, so please check our Website for the latest information.

Insulation distance (Between contact and coil)

Clearance: 5.29 mm, Creepage: 5.35 mm (UL/C-UL, TÜV)

UL/C-UL (Approved)

File No.	Contact rating	Operations	Ambient temperature
E43149	5 A 250 V AC Resistive	50 x 10 ³	40°C
	5 A 250 V AC Resistive	10 x 10 ³	90°C
	5 A 30 V DC General use	50 x 10 ³	40°C
	5 A 30 V DC General use	10 x 10 ³	90°C
	3 A 250 V AC General use	10 x 10 ³	90°C
	3 A 250 V AC Resistive	100 x 10 ³	40°C
	3 A 30 V DC General use	100 x 10 ³	40°C
	Pilot Duty B300, R300*	6 x 10 ³	40°C
E479891	Class I Division2 Groups A, B, C, D Hazardous Location (ANSI/ISA 12.12.01-2015, CAN/CSA C22.2 No.213-15)		

*Pilot Duty is in accordance with the conditions of UL508.

CSA (Approved)

CSA standard certified by C-UL

TÜV (Approved)

File No.	Contact rating	Operations	Ambient temperature
B 18 03 13461 368	5 A 250 V AC (cosφ=1.0)	50 x 10 ³	40°C
	5 A 250 V AC (cosφ=1.0)	10 x 10 ³	90°C
	5 A 30 V DC (0 ms)	50 x 10 ³	40°C
	5 A 30 V DC (0 ms)	10 x 10 ³	90°C
	3 A 250 V AC (cosφ=1.0)	100 x 10 ³	40°C
	3 A 250 V AC (cosφ=1.0)	100 x 10 ³	40°C
	3 A 30 V DC (0 ms)	100 x 10 ³	40°C
	3 A 30 V DC (0 ms)	100 x 10 ³	40°C

GUIDELINES FOR USAGE

For cautions for use, please read "GUIDELINES FOR RELAY USAGE".

https://industrial.panasonic.com/ac/e/control/relay/cautions_use/index.jsp

Cautions for usage of PA-N relay

- Specification values for operate and release voltages are for the relay mounting with its terminals below.

Please refer the figure regarding fluctuations in the operate and release voltages caused by the installation direction.

Tested sample: APAN3124, 6 pcs.
Ambient temperature: 20°C
Measured direction: 6 directions

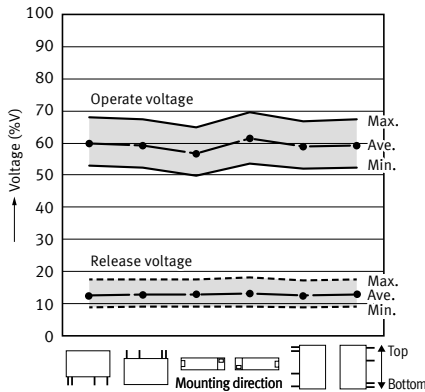

- When mounting the relays within 1 mm, please notice the condition below.

1) Mount the relays in the same direction.

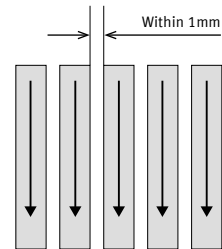

2) Coil terminals (Terminal No. 1 & 2) polarity should be arranged in the same direction.

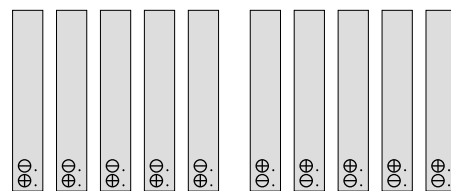

PA-N RELAYS PC board socket/Self-clinching terminal socket

RoHS



Standard type terminal socket



Self-clinching type terminal socket

TYPES

Product name	Type No.	Part No.	Standard packing	
			Inner carton	Outer carton
PC board socket	PA1a-PS	APA831	50 pcs.	500 pcs.
Self-clinching terminal socket	PA1a-PS-H	APA832		

RATING

Item	Specifications
Dielectric strength (initial)	Between pin No. 2 and 5: 2,000 Vrms for 1 min (detection current: 10 mA) Between pin No. 5 and 6: 2,000 Vrms for 1 min (detection current: 10 mA)
Insulation resistance (initial)	Each between terminals: Min. 1,000 MΩ (at 500 V DC, Measured portion is the same as the case of dielectric strength.)
Max. carrying current	3 A
Conditions for usage, transport and storage	Ambient temperature: -40 to +70°C Humidity: 5 to 85% RH (Avoid icing and condensation)

DIMENSIONS

CAD The CAD data of the products with a "CAD" mark can be downloaded from our Website.

Unit: mm

PC board socket

CAD

External dimensions

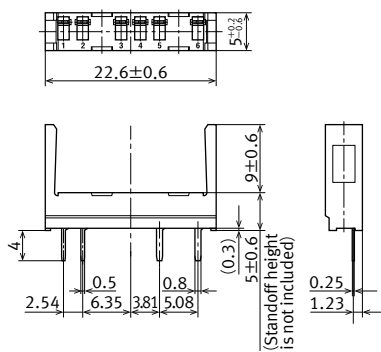

General tolerance ± 0.3

Recommended PC board pattern (BOTTOM VIEW)

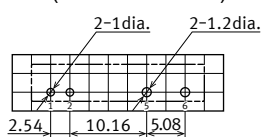

Tolerance ± 0.1

Self-clinching terminal socket

CAD

External dimensions

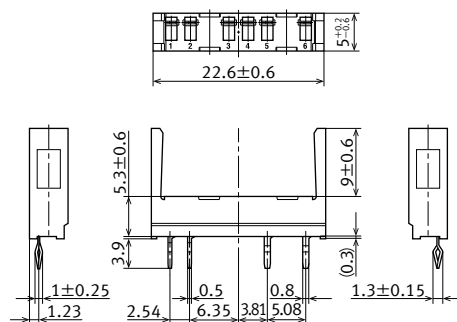

General tolerance ± 0.3

Recommended PC board pattern (BOTTOM VIEW)

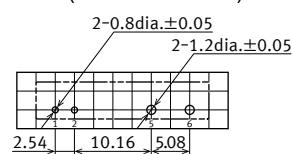

Tolerance ± 0.1

HANDLING

■ Mounting method of relay

1) Match the direction of relay and socket.

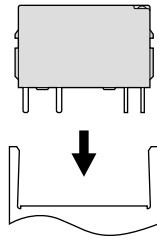

2) Insert both ends of the relay securely all the way in until both hooks clear the ribs on the relay case.

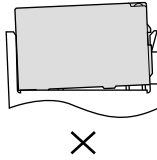
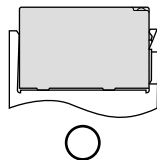

■ Removing method of relay

1) Remove the relay, applying force in the direction shown below.

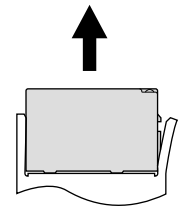

2) In case there is not enough space for finger to pick relay up, use screwdrivers in the way shown.

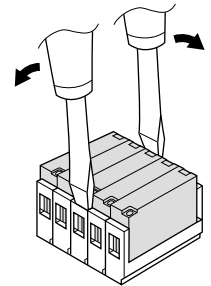

3) When using the removal key (APA801), remove the relay as shown in the figure. You can purchase the removal key (APA801) as an accessories.

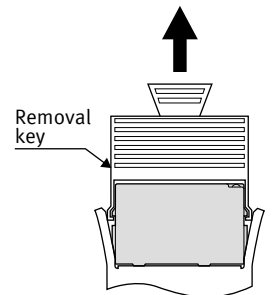

4) Exercise care when removing relays. If greater than necessary force is applied at the socket hooks, deformation may alter the dimensions so that the hook will no longer catch, and other damage may also occur.

GUIDELINES FOR POWER, HIGH-CAPACITY DC CUT OFF AND SAFETY RELAYS USAGE

■ For cautions for use, please read “GUIDELINES FOR RELAY USAGE”.
https://industrial.panasonic.com/ac/e/control/relay/cautions_use/index.jsp

Precautions for Coil Input

■ Long term current carrying

A circuit that will be carrying a current continuously for long periods without relay switching operation. (circuits for emergency lamps, alarm devices and error inspection that, for example, revert only during malfunction and output warnings with form B contacts)
Continuous, long-term current to the coil will facilitate deterioration of coil insulation and characteristics due to heating of the coil itself. For circuits such as these, please use a magnetic-hold type latching relay. If you need to use a single stable relay, use a sealed type relay that is not easily affected by ambient conditions and make a failsafe circuit design that considers the possibility of contact failure or disconnection.

■ DC Coil operating power

Steady state DC current should be applied to the coil. The wave form should be rectangular. If it includes ripple, the ripple factor should be less than 5%.

However, please check with the actual circuit since the electrical characteristics may vary. The rated coil voltage should be applied to the coil and the set/reset pulse time of latching type relay differs for each relays, please refer to the relay's individual specifications.

■ Coil connection

When connecting coils of polarized relays, please check coil polarity (+,-) at the internal connection diagram (Schematic). If any wrong connection is made, it may cause unexpected malfunction, like abnormal heat, fire and so on, and circuit do not work. Avoid impressing voltages to the set coil and reset coil at the same time.

■ Maximum allowable voltage and temperature rise

Proper usage requires that the rated coil voltage be impressed on the coil. Note, however, that if a voltage greater than or equal to the maximum continuous voltage is impressed on the coil, the coil may burn or its layers short due to the temperature rise. Furthermore, do not exceed the usable ambient temperature range listed in the catalog.

■ Operate voltage change due to coil temperature rise

In DC relays, after continuous passage of current in the coil, if the current is turned OFF, then immediately turned ON again, due to the temperature rise in the coil, the operate voltage will become somewhat higher. Also, it will be the same as using it in a higher temperature atmosphere. The resistance/temperature relationship for copper wire is about 0.4% for 1°C, and with this ratio the coil resistance increases. That is, in order to operate of the relay, it is necessary that the voltage be higher than the operate voltage and the operate voltage rises in accordance with the increase in the resistance value. However, for some polarized relays, this rate of change is considerably smaller.

Ambient Environment

■ Usage, Transport, and Storage Conditions

During usage, storage, or transportation, avoid locations subjected to direct sunlight and maintain normal temperature, humidity and pressure conditions.

● Temperature/Humidity/Pressure

When transporting or storing relays while they are tube packaged, there are cases the temperature may differ from the allowable range. In this case be sure to check the individual specifications. Also allowable humidity level is influenced by temperature, please check charts shown below and use relays within mentioned conditions. (Allowable temperature values differ for each relays, please refer to the relay's individual specifications.)

1) Temperature:

The tolerance temperature range differs for each relays, please refer to the relay's individual specifications

2) Humidity: 5 to 85 % RH

3) Pressure: 86 to 106 kPa

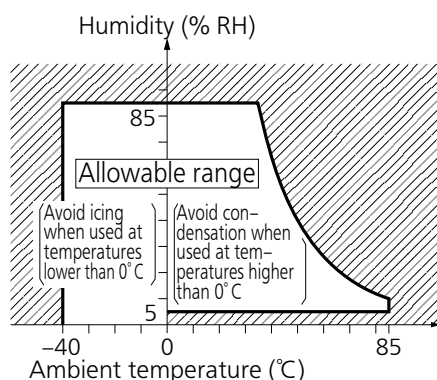

● Dew condensation

Condensation occurs when the ambient temperature drops suddenly from a high temperature and humidity, or the relay is suddenly transferred from a low ambient temperature to a high temperature and humidity. Condensation causes the failures like insulation deterioration, wire disconnection and rust etc.

Panasonic Industry Co., Ltd. does not guarantee the failures caused by condensation.

The heat conduction by the equipment may accelerate the cooling of device itself, and the condensation may occur.

Please conduct product evaluations in the worst condition of the actual usage. (Special attention should be paid when high temperature heating parts are close to the device. Also please consider the condensation may occur inside of the device.)

● Icing

Condensation or other moisture may freeze on relays when the temperature become lower than 0°C. This icing causes the sticking of movable portion, the operation delay and the contact conduction failure etc. Panasonic Industry Co., Ltd. does not guarantee the failures caused by the icing.

The heat conduction by the equipment may accelerate the cooling of relay itself and the icing may occur. Please conduct product evaluations in the worst condition of the actual usage.

● Low temperature and low humidity

The plastic becomes brittle if the switch is exposed to a low temperature, low humidity environment for long periods of time.

● High temperature and high humidity

Storage for extended periods of time (including transportation periods) at high temperature or high humidity levels or in atmospheres with organic gases or sulfide gases may cause a sulfide film or oxide film to form on the surfaces of the contacts and/or it may interfere with the functions. Check out the atmosphere in which the units are to be stored and transported.

● Package

In terms of the packing format used, make every effort to keep the effects of moisture, organic gases and sulfide gases to the absolute minimum.

● Silicon

When a source of silicone substances (silicone rubber, silicone oil, silicone coating materials and silicone filling materials etc.) is used around the relay, the silicone gas (low molecular siloxane etc.) may be produced.

This silicone gas may penetrate into the inside of the relay. When the relay is kept and used in this condition, silicone compound may adhere to the relay contacts which may cause the contact failure.

Do not use any sources of silicone gas around the relay (Including plastic seal types).

● NOx Generation

When relay is used in an atmosphere high in humidity to switch a load which easily produces an arc, the NOx created by the arc and the water absorbed from outside the relay combine to produce nitric acid.

This corrodes the internal metal parts and adversely affects operation.

Avoid use at an ambient humidity of 85%RH or higher (at 20°C). If use at high humidity is unavoidable, please contact our sales representative.

Others

■ Cleaning

• Although the environmentally sealed type relay (plastic sealed type, etc.) can be cleaned, avoid immersing the relay into cold liquid (such as cleaning solvent) immediately after soldering. Doing so may deteriorate the sealing performance.

• Cleaning with the boiling method is recommended(The temperature of cleaning liquid should be 40°C or lower).

Avoid ultrasonic cleaning on relays. Use of ultrasonic cleaning may cause breaks in the coil or slight sticking of the contacts due to ultrasonic energy.

Please refer to **"the latest product specifications"** when designing your product.

•Requests to customers:

<https://industrial.panasonic.com/ac/e/salespolicies/>

Panasonic
INDUSTRY

Panasonic Industry Co., Ltd.

Electromechanical Control Business Division
■1006, Oaza Kadoma, Kadoma-shi, Osaka 571-8506, Japan
industrial.panasonic.com/ac/e/

Mouser Electronics

Authorized Distributor

Click to View Pricing, Inventory, Delivery & Lifecycle Information:

Panasonic:

[APAN3105](#) [APAN3118](#) [APAN3103](#) [APAN3112](#) [APAN3109](#) [APAN314H](#) [APAN3124](#) [APAN3106](#)