

WAU20-500

Electrical Specifications (@25C)

1. Primary Rating: 120V 60Hz (13.5W @ Full Load)
2. Primary Excitation Current: 85mA Max
3. Secondary Rating: 20VAC \pm 5%, 500mA AC
4. Secondary No-Load Rating: 21.65VAC Ref.
5. Operating Temperature Range: -10 Deg C to +40 Deg C
6. Temperature Rise: 75 Deg C Max at rated load
50 Deg C Max on enclosure surface

Mechanical Parameters:

Case Type: Thermoplastic molded enclosure.
Output Cord: 24 AWG, 6 Ft. Long Min.

Agency File:

UL/CUL: File E245587, UL 1310

A. Dimensions:

H	W	D
80	60	48

*Units: In Millimeter

B. Schematic:

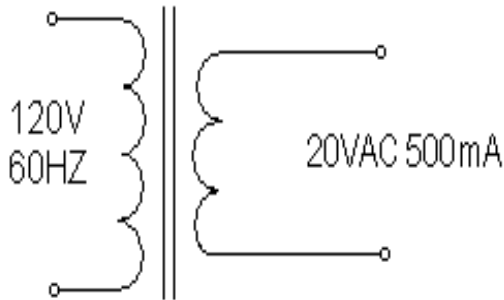

DOE Compliance: Effective December 30, 2017, the DOE will now not consider an external power supply with specific characteristics to meet the definition of a device that is subject to EPCA regulation, as long as the power supply is not distributed for use with consumer products.

RoHS Compliance: As of manufacturing date February 2016, all standard products meet the requirements of 2015/863/EU, known as the RoHS 3 initiative.

* Upon printing, this document is considered “uncontrolled”. Please contact Triad Magnetics’ website for the most current version.

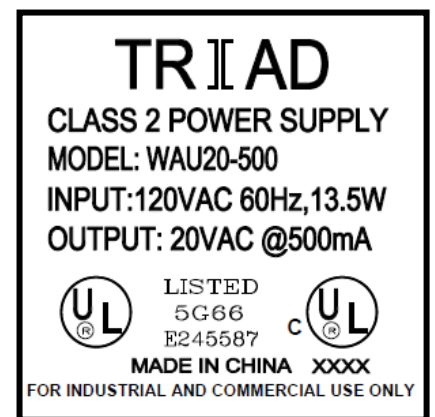
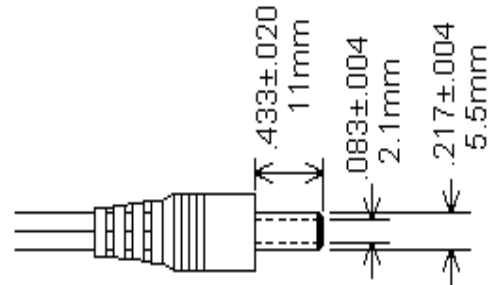
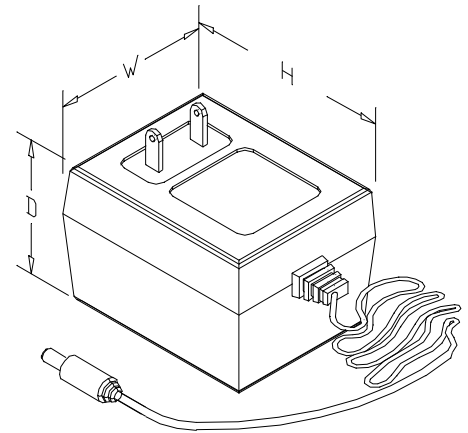

Mouser Electronics

Authorized Distributor

Click to View Pricing, Inventory, Delivery & Lifecycle Information:

[Triad Magnetics:](#)

[WAU20-500](#)