

# Compact Guide Cylinder

ø12, ø16, ø20, ø25, ø32, ø40, ø50, ø63, ø80, ø100

Up to  
**17%**  
Weight  
reduced!

Weight reduced by up to 17% with  
a shorter guide rod and thinner plate

- With air cushion
- Water resistant cylinder are now available.

New



With air cushion

New



Water resistant cylinder



Guide rod shortened  
for MGPM40-25 stroke

Max. **22**mm

Space required between the  
bottom of the cylinder body and  
your equipment is reduced.

Space saving

Round type and magnetic field resistant auto switches are mountable directly without spacer.

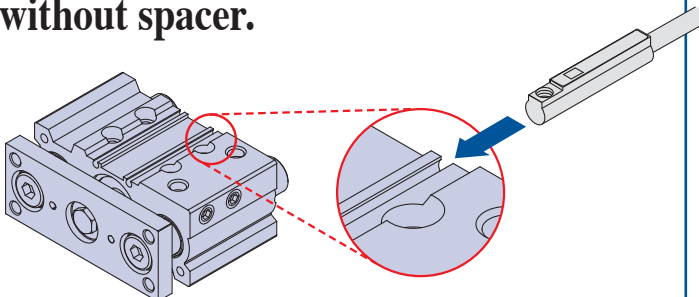

3 types of bearing can be selected.

- Slide bearing Series MGPM
- Ball bushing Series MGPL
- High precision ball bushing Series MGPA

Made to Order

Change of guide rod end shape (-XA□), intermediate stroke (-XB10), low speed cylinder (-XB13), side porting type (-X867), made of stainless steel (-XC6), adjustable stroke cylinder/adjustable extension type (-XC8), and with coil scraper (-XC35) etc. are now available.

Series **MGP**



CAT.EUS20-219C-UK

## 3 types of bearing can be selected.

**Slide bearing**  
**Series MGPM**

Suitable for lateral load applications such as a stopper where shock is applied

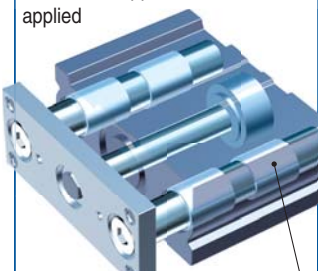

Slide bearing

**Ball bushing**  
**Series MGPL**

Smooth operation suitable for pusher and lifter

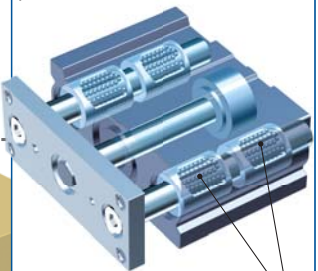

Ball bushing

**High precision ball bushing**  
**Series MGPA**

Suitable for minimising plate displacement

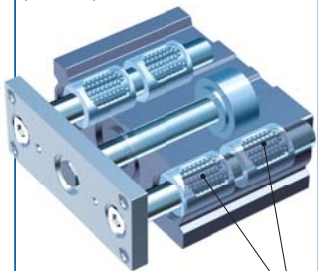

High precision ball bushing

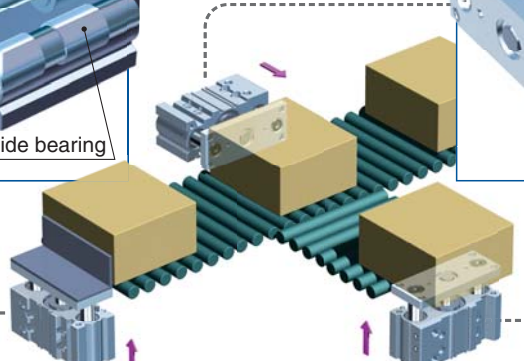

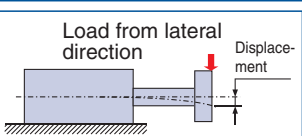

Load from lateral direction  
Displacement

## Basic Type

### Weight reduced

Bore size [mm]	Reduction rate [%]	Weight [kg]
ø12	11	0.25
ø16	3	0.37
ø20	12	0.59
ø25	12	0.84
ø32	17	1.41
ø40	16	1.64
ø50	17	2.79
ø63	17	3.48
ø80	17	5.41
ø100	13	9.12

\* Compared with the slide bearing type, ø12 to ø25-20 stroke  
 \* Compared with the slide bearing type, ø32 to ø100-25 stroke

### Guide rod shortened

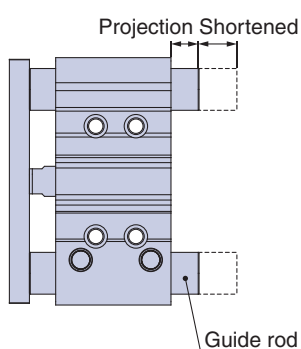

Bore size	Guide rod [mm]	
	Shortened by	New dimension
ø32	22	15.5
ø40	22	9
ø50	18	16.5
ø63	18	11.5
ø80	10.5	8
ø100	10.5	10.5

\* Compared with the slide bearing type, 25 stroke (ø32 to ø100)  
 (No projection for ø12 to ø25-25 stroke)

### Performance and strength (rigidity) are equivalent to the conventional MGP series.

### Mounting dimensions are equivalent to the conventional MGP series.

### Series MGP (Basic Type), Stroke Variations

Bearing type	Bore size [mm]	Stroke [mm]																Made to Order	
		10	20	25	30	40	50	75	100	125	150	175	200	250	300	350	400		
MGPM Slide bearing	12	●	●																<ul style="list-style-type: none"> <li>-XA□: Change of guide rod end shape</li> <li>-XB6: Heat resistant cylinder (-10 to 150°C)</li> <li>-XB10: Intermediate stroke (Using exclusive body)</li> <li>-XB13: Low speed cylinder (5 to 50 mm/s)</li> <li>-XC6: Made of stainless steel</li> <li>-XC8: Adjustable stroke cylinder/Adjustable extension type</li> <li>-XC22: Fluororubber seal</li> <li>-XC35: With coil scraper</li> <li>-XC79: Machining tapped hole, drilled hole and pin hole additionally</li> <li>-XC82: Bottom mounting type</li> <li>-X144: Symmetrical port position</li> <li>-X867: Side porting type (Plug location changed)</li> </ul>
	16	●	●																
	20	●	●	●	●	●	●	●	●	●	●	●	●	●	●	●	●	●	
MGPL Ball bushing	25		●	●	●	●	●	●	●	●	●	●	●	●	●	●	●	●	
	32			●	●	●	●	●	●	●	●	●	●	●	●	●	●	●	
	40				●	●	●	●	●	●	●	●	●	●	●	●	●	●	
MGPA High precision ball bushing	50				●	●	●	●	●	●	●	●	●	●	●	●	●	●	
	63					●	●	●	●	●	●	●	●	●	●	●	●	●	
	80						●	●	●	●	●	●	●	●	●	●	●	●	
	100							●	●	●	●	●	●	●	●	●	●	●	

\* Refer to front matter 1 for details.

Small auto switches or magnetic field resistant auto switches can be mounted on **2 surfaces**.

- D-M9□
- D-A9□
- D-P3DW

\* The D-Y7 and D-Z7 auto switches are not mountable.

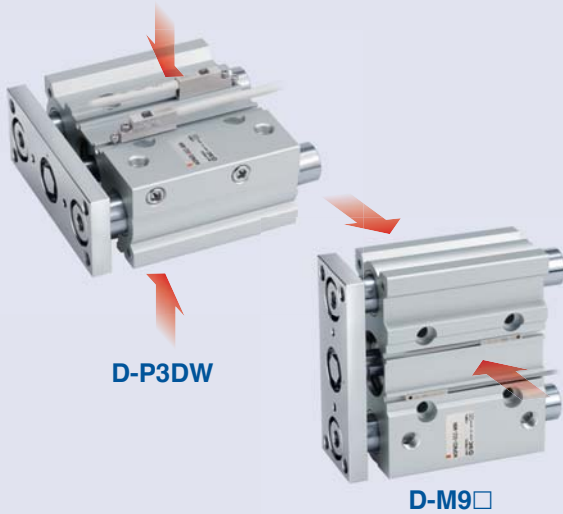

**4 types** of mounting are possible.

Easy positioning  
Knock pin holes provided on each mounting surface

**1. Top mounting**

**2. Side mounting**

**3. T-slot side mounting**

Easy adjustment of workpiece and cylinder mounting

**4. Bottom mounting**

**Piping is possible from 2 directions.**

**1. Top ported**

**2. Side ported**

**New With Air Cushion**

Weight reduced by up to **24%**

Guide rod shortened by up to **35.5 mm** (MGPM100-50)

Bore size [mm]	Reduction rate [%]	Weight [kg]
ø16	12	1.28
ø20	18	1.91
ø25	22	2.52
ø32	24	3.57
ø40	23	4.13
ø50	23	6.56
ø63	22	8.04
ø80	21	11.35
ø100	19	17.72

\* Compared with the conventional MGPM with air cushion, 200 stroke

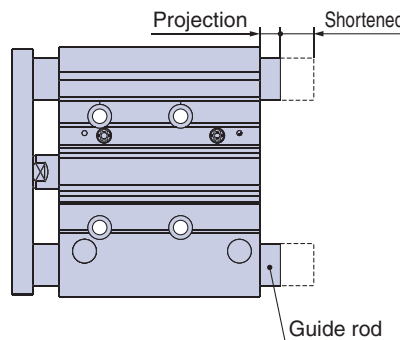

Bore size	Guide rod [mm]	
	Shortened by	New dimension
ø32	33.5	9
ø40	33.5	2.5
ø50	22	12.5
ø63	22	7.5
ø80	35.5	10
ø100	35.5	10.5

\* Compared with the conventional MGPM with air cushion, 50 stroke

Performance and strength are equivalent to the conventional MGP series with air cushion.

Mounting dimensions are equivalent to the conventional MGP series with air cushion.









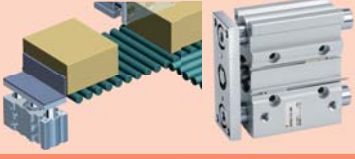

**Series MGP (With Air Cushion), Stroke Variations**

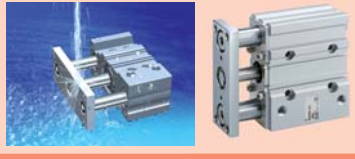
Bearing type	Bore size [mm]	Stroke [mm]											Made to Order	
		25	50	75	100	125	150	175	200	250	300	350		400
MGPM-□A Slide bearing	16	●	●	●	●	●	●	●	●	●	●	●	●	<p>-XC19: Intermediate stroke (Spacer type)</p> <p>-XC79: Tapped hole, drilled hole, pinned hole machined additionally</p> <p>-X867: Side porting type (Plug location changed)</p>
	20	●	●	●	●	●	●	●	●	●	●	●	●	
	25	●	●	●	●	●	●	●	●	●	●	●	●	
MGPL-□A Ball bushing	32	●	●	●	●	●	●	●	●	●	●	●	●	
	40	●	●	●	●	●	●	●	●	●	●	●	●	
	50	●	●	●	●	●	●	●	●	●	●	●	●	
MGPA-□A High precision ball bushing	63	●	●	●	●	●	●	●	●	●	●	●	●	
	80	●	●	●	●	●	●	●	●	●	●	●	●	
	100	●	●	●	●	●	●	●	●	●	●	●	●	

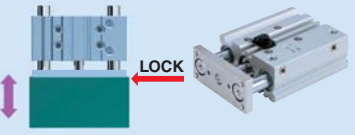
\* Refer to front matter 1 for details.

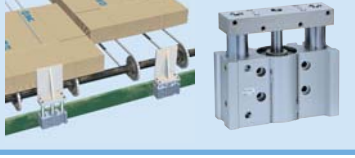
# Compact Guide Cylinders, Series Variations

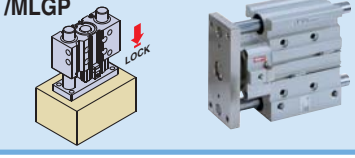
★ New

Series MGP-Z		Bore size											Page		
Series	Bearing type	6	10	12	16	20	25	32	40	50	63	80		100	
<b>Basic type/MGP</b> 	Slide bearing			●	●	●	●	●	●	●	●	●	●	Page 3	
	Ball bushing														
<b>With air cushion/MGP-A</b> 	High precision ball bushing				★	★	★	★	★	★	★	★	★	Page 23	
	Slide bearing														
<b>Water resistant cylinder/MGP R/V</b> 	Slide bearing					★	★	★	★	★	★	★	★	Page 5	
	Ball bushing														
<b>Series MGP</b>													 <a href="http://www.smc.eu">www.smc.eu</a>		
<b>With end lock/MGP-H/R</b> 	Slide bearing														
	Ball bushing						●	●	●	●	●	●		●	
	High precision ball bushing														
<b>Clean series/12/13-MGP</b> 	Ball bushing			●	●	●	●	●	●	●	●				
	Slide bearing														
<b>Heavy duty guide rod/MGPS</b> 	Slide bearing									●		●			
	Ball bushing														
<b>Miniature Guide Rod Cylinder/MGJ</b> 	Slide bearing	●	●												
	Ball bushing														
<b>Compact Guide Cylinder with Lock /MLGP</b> 	Slide bearing														
	Ball bushing									●	●	●		●	●
<b>Hygienic Design Cylinder/HYG</b> 	Slide bearing														
	Ball bushing									●	●	●	●	●	

# Combination of Standard Products and Made to Order Specifications

## Series MGP

- : Standard
- : Made to Order
- : Special product (Please contact SMC for details.)
- : Not available

			Basic type			With air cushion		
			Slide bearing	Ball bushing	High precision ball bushing	Slide bearing	Ball bushing	High precision ball bushing
			MGPM	MGPL	MGPA	MGPM	MGPL	MGPA
Symbol	Specifications	Applicable bore size	ø12 to ø100			ø16 to ø100		
	Basic type		●	●	●	—	—	—
	With air cushion		—	—	—	●	●	●
25A-	Copper (Cu) and Zinc (Zn)-free <sup>Note 1)</sup>	ø12 to ø100	●	●	○	○	○	○
20-	Copper and Fluorine-free <sup>Note 1)</sup>	ø12 to ø100	●	● <sup>Note 3)</sup>	● <sup>Note 3)</sup>	●	● <sup>Note 3)</sup>	● <sup>Note 3)</sup>
R/V	Water resistant	ø20 to ø100	●	—	—	○	—	—
MGP□M	Cylinder with Stable Lubrication Function (Lube-retainer)		●	●	○	○	○	○
-XA□	Change of guide rod end shape	ø12 to ø100	○	○	○	○	○	○
-XB6	Heat resistant cylinder (-10 to 150°C) <sup>Note 2)</sup>		○	—	—	○	—	—
-XB10	Intermediate stroke (Using exclusive body)		○	○	○	○	○	○
-XB13	Low speed cylinder (5 to 50 mm/s)		○	○	○	○	○	○
-XC4	With heavy duty scraper	ø20 to ø100	○	○	○	○	○	○
-XC6	Made of stainless steel	ø12 to ø100	○	○	—	○	○	—
-XC8	Adjustable stroke cylinder/Adjustable extension type		○	○	○	—	—	—
-XC9	Adjustable stroke cylinder/Adjustable retraction type <sup>Note 2)</sup>		○	○	○	—	—	—
-XC19	Intermediate stroke (Spacer type)	ø16 to ø100	—	—	—	○	○	○
-XC22	Fluororubber seal <sup>Note 2)</sup>	ø12 to ø100	○	—	—	○	—	—
-XC35	With coil scraper	ø20 to ø100	○	○	○	○	○	○
-XC79	Tapped hole, drilled hole, pinned hole machined additionally	ø12 to ø100	○	○	○	○	○	○
-XC82	Bottom mounting type		○	—	—	○	—	—
-XC85	Grease for food processing equipment		○	○	○	○	○	○
-X144	Symmetrical port position		○	○	○	○	○	○
-X867	Side porting type (Plug location changed)		○	○	○	○	○	○

Note 1) Consult SMC for details.

Note 2) Without cushion

Note 3) Copper and fluorine-free are available as standard products.

Basic Type

MGP

With Air Cushion

MGP

Auto Switch

Made to Order



# Series MGP

## Specific Product Precautions 1

Be sure to read before handling. Refer to back cover for Safety Instructions.

For Actuator and Auto Switch Precautions, refer to "Handling Precautions for SMC Products" and the Operation Manual on SMC website, <http://www.smcworld.com>

### Mounting

#### Warning

1. Never place your hands or fingers between the plate and the body.

Be very careful to prevent your hands or fingers from getting caught in the gap between the cylinder body and the plate when air is applied.

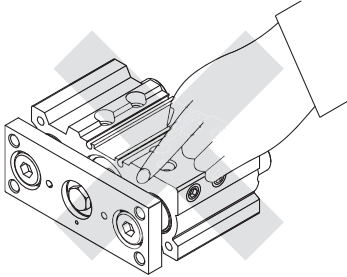

#### Caution

1. Use cylinders within the piston speed range.

An orifice is set for this cylinder, but the piston speed may exceed the operating range if the speed controller is not used. If the cylinder is used outside the operating speed range, it may cause damage to the cylinder and shorten the service life. Adjust the speed by installing the speed controller and use the cylinder within the limited range.

2. Pay attention to the operating speed when the product is mounted vertically.

When using the product in the vertical direction, if the load factor is large, the operating speed can be faster than the control speed of the speed controller (i.e. quick extension). In such cases, it is recommended to use a dual speed controller.

3. Do not scratch or gouge the sliding portion of the piston rod and the guide rod.

Damaged seals etc. will result in leakage or malfunction.

4. Do not dent or scratch the mounting surface of the body and the plate.

The flatness of the mounting surface may not be maintained, which would cause an increase in sliding resistance.

5. Make sure that the cylinder mounting surface has a flatness of 0.05 mm or less.

If the flatness of the workpieces and brackets mounted on the plate is not appropriate, sliding resistance may increase. If it is difficult to maintain a flatness of 0.05 or less, put a thin shim ring (prepared by user) between the plate and workpiece mounting surface to prevent the sliding resistance from increasing.

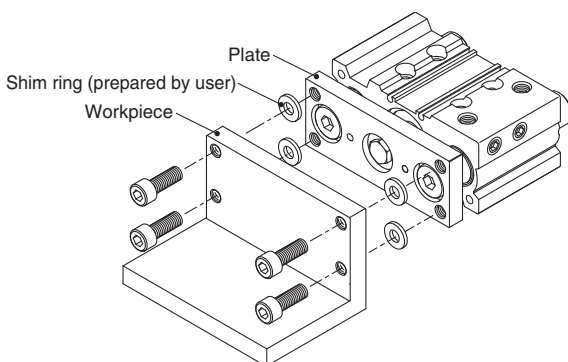

### Mounting

#### Caution

6. Bottom of cylinder

The guide rods protrude from the bottom of the cylinder at the end of the retracting stroke, and therefore, in cases where the cylinder is to be bottom mounted, it is necessary to provide bypass ports in the mounting surface for the guide rods, as well as holes for the hexagon socket head cap screws which are used for mounting. Moreover, in applications where impact occurs from a stopper etc., the mounting screws should be inserted to a depth of 2d or more.

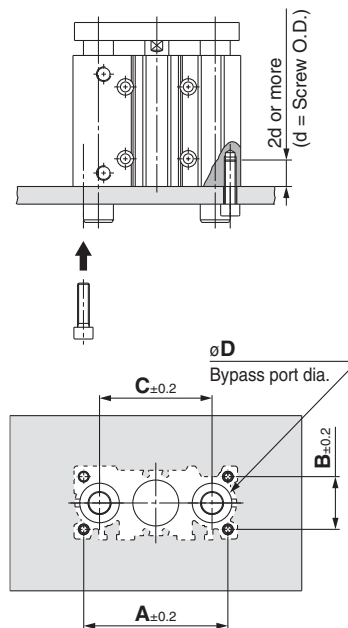

Bore size [mm]	A [mm]	B [mm]	C [mm]	D [mm]		Hexagon socket head cap screw
				MGPM	MGPL/A	
12*	50	18	41	10	8	M4 x 0.7
16	56	22	46	12	10	M5 x 0.8
20	72	24	54	14	12	M5 x 0.8
25	82	30	64	18	15	M6 x 1.0
32	98	34	78	22	18	M8 x 1.25
40	106	40	86	22	18	M8 x 1.25
50	130	46	110	27	22	M10 x 1.5
63	142	58	124	27	22	M10 x 1.5
80	180	54	156	33	28	M12 x 1.75
100	210	62	188	39	33	M14 x 2.0

\* Air cushions are not available for bore size 12.



# Series MGP

## Specific Product Precautions 2

Be sure to read before handling. Refer to back cover for Safety Instructions.  
For Actuator and Auto Switch Precautions, refer to "Handling Precautions for SMC Products" and the Operation Manual on SMC website, <http://www.smcworld.com>

### Piping

#### Caution

Depending on the operating conditions, piping port positions can be changed by using a plug.

##### 1. M5

After tightening by hand, tighten additional 1/6 to 1/4 rotation with a tightening tool.

##### 2. Tapered thread for Rc port (MGP) and NPT port (MGP□□TN)

Use the correct tightening torques listed below. Before tightening the plug, wrap pipe tape around it. Also, with regard to the sunk dimension of a plug (dimension "a" in the drawing), use the stipulated figures as a guide and confirm the air leakage before operation.

\* If tightening plugs on the top mounting port with more than the proper tightening torque, plugs will be screwed much deeply and air passage will be squeezed. Consequently, the cylinder speed will be restricted.

Connection thread (plug) size	Proper tightening torque [N·m]	a dimension
1/8	7 to 9	0.5 mm or less
1/4	12 to 14	1 mm or less
3/8	22 to 24	1 mm or less

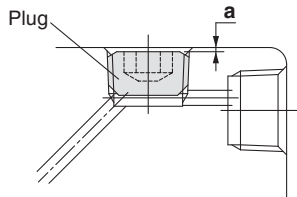

##### 3. Parallel pipe thread for G port (MGP□□TF)

Screw in the plug to the surface of the body (dimension "a" in the drawing) by checking visually instead of using the tightening torque shown in the table.

### Cushion

#### With air cushion

#### Warning

##### 1. Do not open the cushion valve excessively.

Air leakage will occur if operated after opening by 4 rotations or more. Furthermore, a stopper mechanism is provided for the cushion valve, and it should not be forced open beyond that position. Be aware that the cushion valve may jump up from the cover when the air is supplied.

#### Caution

##### 1. Be sure to use the cylinder after the air cushion has been adjusted appropriately.

First, fully close the cushion valve. Start the operation at the cylinder speed to be used with the load applied, and then open the cushion valve gradually to make the adjustment. The optimal adjustment is that the piston reaches its stroke end and the collision sound is minimised. If the cushion valve is used without adjusting the air cushion appropriately, this may cause damage to the retaining ring or piston.

Bore size [mm]	Applicable tool
16, 20, 25, 32, 40	JIS B4648 hexagon wrench key 1.5
50, 63, 80, 100	JIS B4648 hexagon wrench key 3

##### 2. Be sure to operate a cylinder equipped with air cushion to the end of the stroke.

If it is not operated to the end of the stroke, the effect of the air cushion will not be fully exhibited. Consequently, in cases where the stroke is regulated by an external stopper etc., caution must be exercised, as the air cushion may become completely ineffective.

### Allowable Kinetic Energy

#### Caution

Load weight and a maximum speed must be within the ranges shown in the graph below.

#### MGP with Rubber Bumper

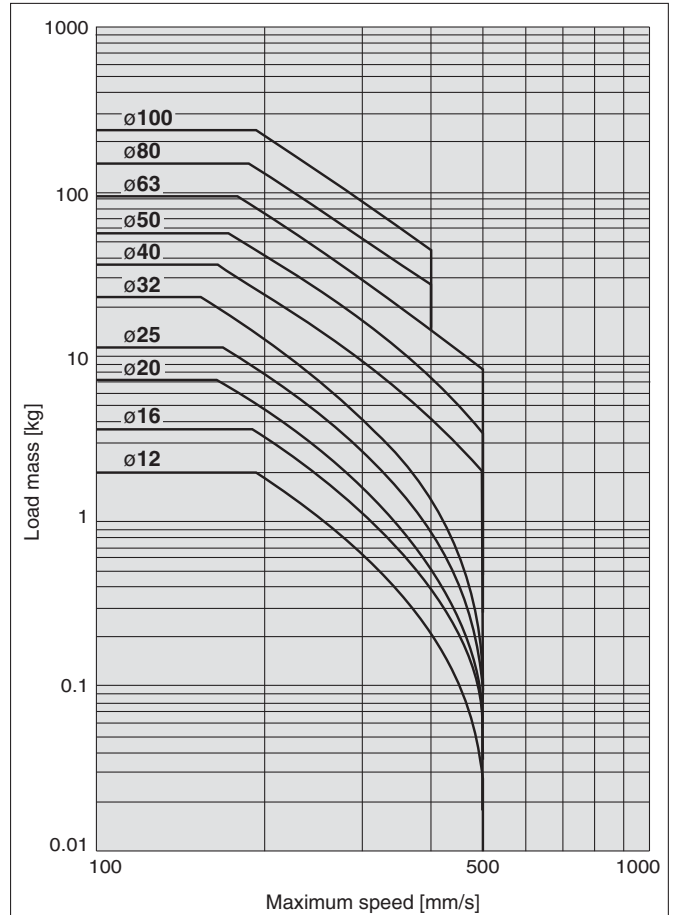

#### MGP with Air Cushion

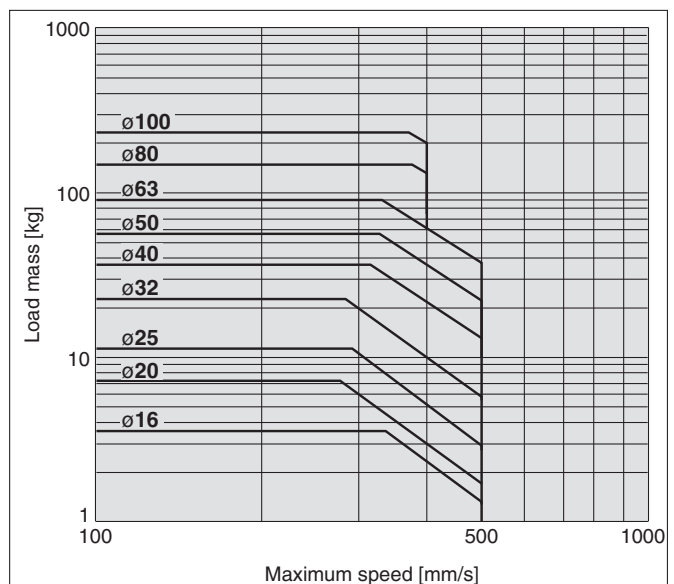

Basic Type

MGP

With Air Cushion

MGP

Auto Switch

Made to Order

# Compact Guide Cylinder

# Series MGP

ø12, ø16, ø20, ø25, ø32, ø40, ø50, ø63, ø80, ø100

## How to Order

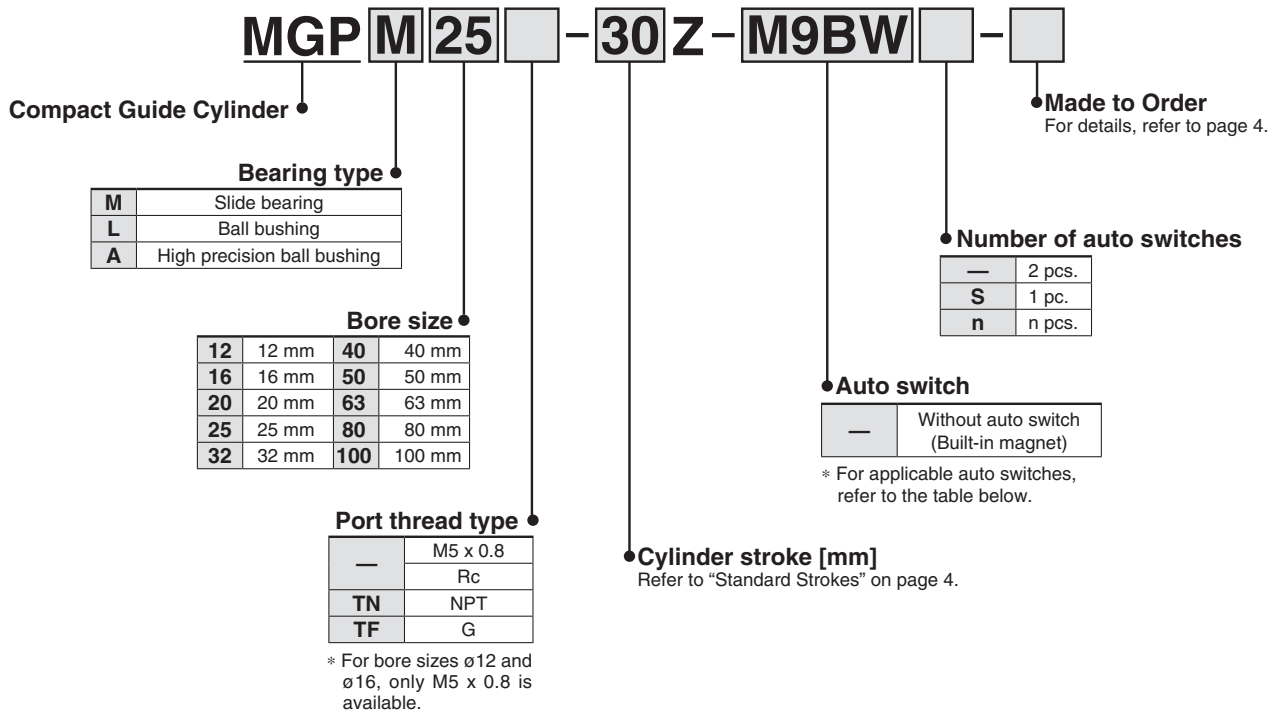

## Applicable Auto Switches/Refer to the Auto Switch Guide for further information on auto switches.

Type	Special function	Electrical entry	Indicator light	Wiring (Output)	Load voltage		Auto switch model		Lead wire length [m]				Pre-wired connector	Applicable load			
					DC	AC	Perpendicular	In-line	0.5 (—)	1 (M)	3 (L)	5 (Z)		IC circuit	Relay, PLC		
Solid state auto switch	—	Grommet	Yes	3-wire (NPN)	24 V	5 V, 12 V	—	M9NV	M9N	●	●	●	○	○	IC circuit	Relay, PLC	
				3-wire (PNP)				M9PV	M9P	●	●	●	○	○			
	2-wire			M9BV	M9B	●	●	●	○	○	○	○	—				
	3-wire (NPN)			M9NWX	M9NX	●	●	●	○	○	○	○	IC circuit				
	3-wire (PNP)			M9PWV	M9PW	●	●	●	○	○	○	○	IC circuit				
	2-wire			M9BWX	M9BX	●	●	●	○	○	○	○	—				
	3-wire (NPN)			M9NAV***	M9NA***	○	○	●	○	○	○	○	IC circuit				
	3-wire (PNP)			M9PAV***	M9PA***	○	○	●	○	○	○	○	IC circuit				
	2-wire			M9BAV***	M9BA***	○	○	●	○	○	○	○	—				
	Magnetic field resistant (2-colour display)			2-wire (Non-polar)	—	—	—	—	P3DWA**	●	—	●	●	○	○		—
Reed auto switch	—	Grommet	Yes	3-wire (NPN equivalent)	24 V	5 V	—	A96V	A96	●	—	●	—	—	IC circuit	Relay, PLC	
				2-wire				100 V	A93V	A93	●	—	●	●	—		—
								100 V or less	A90V	A90	●	—	●	—	—		—

\*\*\* Water resistant type auto switches are mountable on the above models, but in such case SMC cannot guarantee water resistance.

A water resistant type cylinder is recommended for use in an environment which requires water resistance.

However, please contact SMC for water resistant products of ø12 and ø16.

\* Lead wire length symbols: 0.5 m..... — (Example) M9NW  
 1 m..... M (Example) M9NWM  
 3 m..... L (Example) M9NWL  
 5 m..... Z (Example) M9NWZ

\* Solid state auto switches marked with "○" are produced upon receipt of order.

\*\* The D-P3DWA is mountable on bore size ø25 to ø100.

\* Since there are other applicable auto switches than listed above, refer to the Auto Switch Guide for details.

\* For details about auto switches with pre-wired connector, refer to the Auto Switch Guide.

For the D-P3DWA, refer to the D-P3DWA catalogue.

\* Auto switches are shipped together, (but not assembled).



## Specifications

Bore size [mm]	12	16	20	25	32	40	50	63	80	100
<b>Action</b>	Double acting									
<b>Fluid</b>	Air									
<b>Proof pressure</b>	1.5 MPa									
<b>Maximum operating pressure</b>	1.0 MPa									
<b>Minimum operating pressure</b>	0.12 MPa		0.1 MPa							
<b>Ambient and fluid temperature</b>	-10 to 60°C (No freezing)									
<b>Piston speed</b> <small>Note)</small>	50 to 500 mm/s								50 to 400 mm/s	
<b>Cushion</b>	Rubber bumper on both ends									
<b>Lubrication</b>	Not required (Non-lube)									
<b>Stroke length tolerance</b>	$^{+1.5}_0$ mm									

Note) Maximum speed with no load.

Make a model selection, considering a load according to the graph on pages 9 to 15.

## Standard Strokes

Bore size [mm]	Standard stroke [mm]
<b>12, 16</b>	10, 20, 30, 40, 50, 75, 100, 125, 150, 175, 200, 250
<b>20, 25</b>	20, 30, 40, 50, 75, 100, 125, 150, 175, 200, 250, 300, 350, 400
<b>32 to 100</b>	25, 50, 75, 100, 125, 150, 175, 200, 250, 300, 350, 400

## Manufacture of Intermediate Strokes

Description	Spacer installation type		Exclusive body (-XB10)	
	Spacers are installed in the standard stroke cylinder. • $\phi 12$ to $\phi 32$ : Available by the 1 mm stroke interval. • $\phi 40$ to $\phi 100$ : Available by the 5 mm stroke interval.		Dealing with the stroke by making an exclusive body. • All bore sizes are available by the 1 mm interval.	
<b>Model no.</b>	Refer to "How to Order" for the standard model numbers.		Add "-XB10" to the end of standard model number. For details, refer to "Made to Order."	
<b>Applicable stroke [mm]</b>	$\phi 12, \phi 16$	1 to 249	$\phi 12, \phi 16$	11 to 249
	$\phi 20, \phi 25, \phi 32$	1 to 399	$\phi 20, \phi 25$	21 to 399
	$\phi 40$ to $\phi 100$	5 to 395	$\phi 32$ to $\phi 100$	26 to 399
<b>Example</b>	Part no.: MGPM20-39Z A spacer 1 mm in width is installed in the MGPM20-40. C dimension is 77 mm.		Part no.: MGPM20-39Z-XB10 Special body manufactured for 39 stroke. C dimension is 76 mm.	

## Theoretical Output

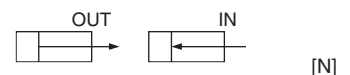

Bore size [mm]	Rod size [mm]	Operating direction	Piston area [mm <sup>2</sup> ]	Operating pressure [MPa]								
				0.2	0.3	0.4	0.5	0.6	0.7	0.8	0.9	1.0
<b>12</b>	6	OUT	113	23	34	45	57	68	79	90	102	113
		IN	85	17	25	34	42	51	59	68	76	85
<b>16</b>	8	OUT	201	40	60	80	101	121	141	161	181	201
		IN	151	30	45	60	75	90	106	121	136	151
<b>20</b>	10	OUT	314	63	94	126	157	188	220	251	283	314
		IN	236	47	71	94	118	141	165	188	212	236
<b>25</b>	10	OUT	491	98	147	196	245	295	344	393	442	491
		IN	412	82	124	165	206	247	289	330	371	412
<b>32</b>	14	OUT	804	161	241	322	402	483	563	643	724	804
		IN	650	130	195	260	325	390	455	520	585	650
<b>40</b>	14	OUT	1257	251	377	503	628	754	880	1005	1131	1257
		IN	1103	221	331	441	551	662	772	882	992	1103
<b>50</b>	18	OUT	1963	393	589	785	982	1178	1374	1571	1767	1963
		IN	1709	342	513	684	855	1025	1196	1367	1538	1709
<b>63</b>	18	OUT	3117	623	935	1247	1559	1870	2182	2494	2806	3117
		IN	2863	573	859	1145	1431	1718	2004	2290	2576	2863
<b>80</b>	22	OUT	5027	1005	1508	2011	2513	3016	3519	4021	4524	5027
		IN	4646	929	1394	1859	2323	2788	3252	3717	4182	4646
<b>100</b>	26	OUT	7854	1571	2356	3142	3927	4712	5498	6283	7069	7854
		IN	7323	1465	2197	2929	3662	4394	5126	5858	6591	7323

Note) Theoretical output [N] = Pressure [MPa] x Piston area [mm<sup>2</sup>]

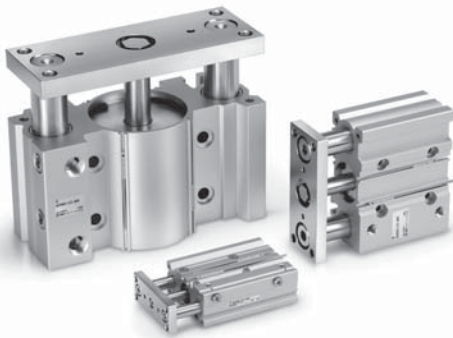

**Symbol**  
Rubber bumper

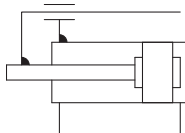

**Made to Order**  
(For details, refer to pages 44 to 55.)

Symbol	Specifications
-XA□	Change of guide rod end shape
-XB6	Heat resistant cylinder (-10 to 150°C)
-XB10	Intermediate stroke (Using exclusive body)
-XB13	Low speed cylinder (5 to 50 mm/s)
-XC4	With heavy duty scraper
-XC6	Made of stainless steel
-XC8	Adjustable stroke cylinder/Adjustable extension type
-XC9	Adjustable stroke cylinder/Adjustable retraction type
-XC22	Fluororubber seal
-XC35	With coil scraper
-XC79	Tapped hole, drilled hole, pinned hole machined additionally
-XC82	Bottom mounting type
-XC85	Grease for food processing equipment
-X144	Symmetrical port position
-X867	Side porting type (Plug location changed)

Refer to pages 40 to 42 for cylinders with auto switches.

- Auto switch proper mounting position (detection at stroke end) and its mounting height
- Minimum stroke for auto switch mounting
- Operating range
- Auto switch mounting brackets/Part no.

Basic Type

MGP

With Air Cushion

MGP

Auto Switch

Made to Order

# Series MGP

## Weights

### Slide Bearing: MGPM12 to 100

[kg]

Bore size [mm]	Standard stroke [mm]															
	10	20	25	30	40	50	75	100	125	150	175	200	250	300	350	400
12	0.22	0.25	—	0.29	0.33	0.36	0.46	0.55	0.66	0.75	0.84	0.93	1.11	—	—	—
16	0.32	0.37	—	0.42	0.46	0.51	0.66	0.78	0.94	1.06	1.18	1.31	1.55	—	—	—
20	—	0.59	—	0.67	0.74	0.82	1.06	1.24	1.43	1.61	1.80	1.99	2.42	2.79	3.16	3.53
25	—	0.84	—	0.94	1.04	1.14	1.50	1.75	2.00	2.25	2.50	2.75	3.35	3.85	4.34	4.84
32	—	—	1.41	—	—	1.77	2.22	2.57	2.93	3.29	3.65	4.00	4.90	5.61	6.33	7.04
40	—	—	1.64	—	—	2.04	2.52	2.92	3.32	3.71	4.11	4.50	5.47	6.26	7.06	7.85
50	—	—	2.79	—	—	3.38	4.13	4.71	5.30	5.89	6.47	7.06	8.55	9.73	10.9	12.1
63	—	—	3.48	—	—	4.15	4.99	5.67	6.34	7.02	7.69	8.37	10.0	11.4	12.7	14.1
80	—	—	5.41	—	—	6.26	7.41	8.26	9.10	9.95	10.8	11.6	13.9	15.6	17.3	19.0
100	—	—	9.12	—	—	10.3	12.0	13.2	14.4	15.6	16.9	18.1	21.2	23.6	26.1	28.5

### Ball Bushing: MGPL12 to 100, High Precision Ball Bushing: MGPA12 to 100

[kg]

Bore size [mm]	Standard stroke [mm]															
	10	20	25	30	40	50	75	100	125	150	175	200	250	300	350	400
12	0.21	0.24	—	0.27	0.32	0.35	0.43	0.50	0.59	0.67	0.75	0.83	0.99	—	—	—
16	0.31	0.35	—	0.40	0.47	0.51	0.62	0.72	0.85	0.96	1.06	1.17	1.38	—	—	—
20	—	0.60	—	0.66	0.79	0.85	1.01	1.17	1.36	1.52	1.68	1.84	2.17	2.49	2.81	3.13
25	—	0.87	—	0.96	1.12	1.20	1.41	1.62	1.86	2.06	2.27	2.48	2.92	3.33	3.75	4.16
32	—	—	1.37	—	—	1.66	2.08	2.37	2.74	3.03	3.31	3.60	4.25	4.82	5.39	5.97
40	—	—	1.59	—	—	1.92	2.38	2.70	3.11	3.44	3.77	4.09	4.81	5.46	6.11	6.76
50	—	—	2.65	—	—	3.14	3.85	4.34	4.97	5.47	5.96	6.45	7.57	8.56	9.54	10.5
63	—	—	3.33	—	—	3.91	4.71	5.29	6.01	6.59	7.17	7.75	9.05	10.2	11.4	12.5
80	—	—	5.27	—	—	6.29	7.49	8.21	8.92	9.64	10.4	11.1	12.9	14.3	15.7	17.2
100	—	—	8.62	—	—	10.1	11.8	12.9	13.9	15.0	16.0	17.1	19.6	21.7	23.8	25.9

## Water Resistant Cylinder

Ideal for use in a machine tool environment exposed to coolants. Applicable for use in an environment with water splashing such as food processing and car wash equipment, etc.



## How to Order

MGPM  **R** -  Z - M9  Water resistant 2-colour indication solid state switch

**Thread type**

—	Rc
N	NPT
TF	G

**Water resistant cylinder**

R	NBR seals (Nitrile rubber)
V	FKM seals (Fluororubber)

- \* Stainless steel plate is available as special products.
- \* Piston rod and guide rod are made of stainless steel.

## Specifications

Applicable series	MGPM
<b>Bearing type</b>	Slide bearing
<b>Bore size [mm]</b>	20, 25, 32, 40, 50, 63, 80, 100
<b>Cushion</b>	MGPM□□R Rubber bumper MGPM□□V Without cushion

- \* Specifications other than above are the same as standard, basic type.
- Note) Consult SMC for details.

## Dimensions

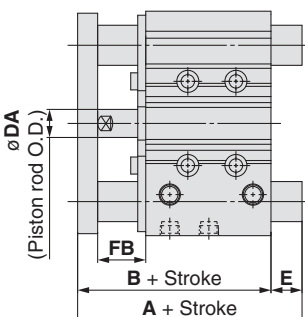

Bore size [mm]	A			B	DA	E			FB
	50 st or less	Over 50 st 200 st or less	Over 200 st			50 st or less	Over 50 st 200 st or less	Over 200 st	
20	66	90.5	123	66	(10)	(0)	(24.5)	(57)	21
25	67.5	91.5	123.5	67.5	(10)	(0)	(24)	(56)	21
32	87	105.5	141.5	71.5	(14)	(15.5)	(34)	(70)	24
40	87	105.5	141.5	78	(14)	(9)	(27.5)	(63.5)	24
50	99.5	120.5	161.5	83	20	(16.5)	(37.5)	(78.5)	27
63	99.5	120.5	161.5	88	20	(11.5)	(32.5)	(73.5)	27
80	110.5	137.5	186.5	102.5	25	(8)	(35)	(84)	30
100	130.5	155.5	194.5	120	30	(10.5)	(35.5)	(74.5)	35

\* The dimensions in ( ) are the same as standard type.

## Cylinder with Stable Lubrication Function (Lube-retainer)



### How to Order

MGP Bearing type Bore size Port thread type **M** — Stroke **Z** — Auto switch

• Cylinder with stable lubrication function (Lube-retainer)

### Dimensions (Dimensions are the same as the standard type.)

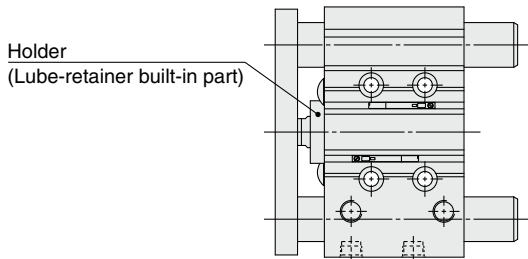

### Specifications

Bore size [mm]	<b>20, 25, 32, 40, 50, 63, 80, 100</b>
<b>Action</b>	Double acting
<b>Minimum operating pressure</b>	0.15 MPa
<b>Cushion</b>	Rubber bumper on both ends

\* Specifications other than above are the same as standard, basic style.

Basic Type

**MGP**

With Air Cushion

**MGP**

**Auto Switch**

**Made to Order**

# Series MGP

## Allowable Rotational Torque of Plate

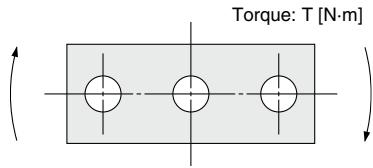

Bore size [mm]	Bearing type	Stroke [mm]															
		10	20	25	30	40	50	75	100	125	150	175	200	250	300	350	400
12	MGPM	0.39	0.32	—	0.27	0.24	0.21	0.43	0.36	0.31	0.27	0.24	0.22	0.19	—	—	—
	MGPL/A	0.61	0.45	—	0.35	0.58	0.50	0.37	0.29	0.24	0.20	0.18	0.16	0.12	—	—	—
16	MGPM	0.69	0.58	—	0.49	0.43	0.38	0.69	0.58	0.50	0.44	0.40	0.36	0.30	—	—	—
	MGPL/A	0.99	0.74	—	0.59	0.99	0.86	0.65	0.52	0.43	0.37	0.32	0.28	0.23	—	—	—
20	MGPM	—	1.05	—	0.93	0.83	0.75	1.88	1.63	1.44	1.28	1.16	1.06	0.90	0.78	0.69	0.62
	MGPL/A	—	1.26	—	1.03	2.17	1.94	1.52	1.25	1.34	1.17	1.03	0.93	0.76	0.65	0.56	0.49
25	MGPM	—	1.76	—	1.55	1.38	1.25	2.96	2.57	2.26	2.02	1.83	1.67	1.42	1.24	1.09	0.98
	MGPL/A	—	2.11	—	1.75	3.37	3.02	2.38	1.97	2.05	1.78	1.58	1.41	1.16	0.98	0.85	0.74
32	MGPM	—	—	6.35	—	—	5.13	5.69	4.97	4.42	3.98	3.61	3.31	2.84	2.48	2.20	1.98
	MGPL/A	—	—	5.95	—	—	4.89	5.11	4.51	6.34	5.79	5.33	4.93	4.29	3.78	3.38	3.04
40	MGPM	—	—	7.00	—	—	5.66	6.27	5.48	4.87	4.38	3.98	3.65	3.13	2.74	2.43	2.19
	MGPL/A	—	—	6.55	—	—	5.39	5.62	4.96	6.98	6.38	5.87	5.43	4.72	4.16	3.71	3.35
50	MGPM	—	—	13.0	—	—	10.8	12.0	10.6	9.50	8.60	7.86	7.24	6.24	5.49	4.90	4.43
	MGPL/A	—	—	9.17	—	—	7.62	9.83	8.74	11.6	10.7	9.83	9.12	7.95	7.02	6.26	5.63
63	MGPM	—	—	14.7	—	—	12.1	13.5	11.9	10.7	9.69	8.86	8.16	7.04	6.19	5.52	4.99
	MGPL/A	—	—	10.2	—	—	8.48	11.0	9.74	13.0	11.9	11.0	10.2	8.84	7.80	6.94	6.24
80	MGPM	—	—	21.9	—	—	18.6	22.9	20.5	18.6	17.0	15.6	14.5	12.6	11.2	10.0	9.11
	MGPL/A	—	—	15.1	—	—	23.3	22.7	20.6	18.9	17.3	16.0	14.8	12.9	11.3	10.0	8.94
100	MGPM	—	—	38.8	—	—	33.5	37.5	33.8	30.9	28.4	26.2	24.4	21.4	19.1	17.2	15.7
	MGPL/A	—	—	27.1	—	—	30.6	37.9	34.6	31.8	29.3	27.2	25.3	22.1	19.5	17.3	15.5

## Non-rotating Accuracy of Plate

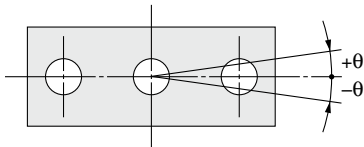

Non-rotating accuracy  $\theta$  when retracted and when no load is applied should be not more than the values shown in the table.

Bore size [mm]	Non-rotating accuracy $\theta$		
	MGPM	MGPL	MGPA
12	$\pm 0.07^\circ$	$\pm 0.05^\circ$	$\pm 0.01^\circ$
16			
20	$\pm 0.06^\circ$	$\pm 0.04^\circ$	
25			
32	$\pm 0.05^\circ$	$\pm 0.03^\circ$	
40			
50	$\pm 0.04^\circ$	$\pm 0.03^\circ$	
63			
80	$\pm 0.03^\circ$	$\pm 0.03^\circ$	
100			

## High Precision Ball Bushing/MGPA

### ⚠ Caution

#### Positioning accuracy for pin hole on the plate

Dispersion of dimensions when machining each component will be accumulated in the plate pin hole positioning accuracy when mounting this cylinder. Values below are referred as a guide.

[Side mounting]

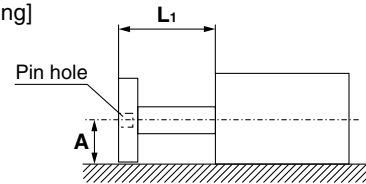

$$A = \text{Catalogue dimension} \pm (0.1 + L1 \times 0.0008) \text{ [mm]}$$

\* : To be 0.15 for  $\phi 80$ ,  $\phi 100$

Note) Displacement by load and self-weight deflection by plate and guide rod are not included.

[Bottom mounting]

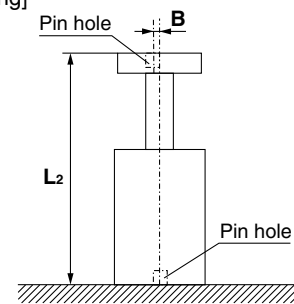

$$B = \pm (0.045 + L2 \times 0.0016) \text{ [mm]}$$

## High Precision Ball Bushing/MGPA Plate Displacement Amount (Reference Values)

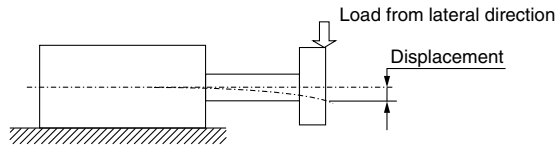

### MGPA12

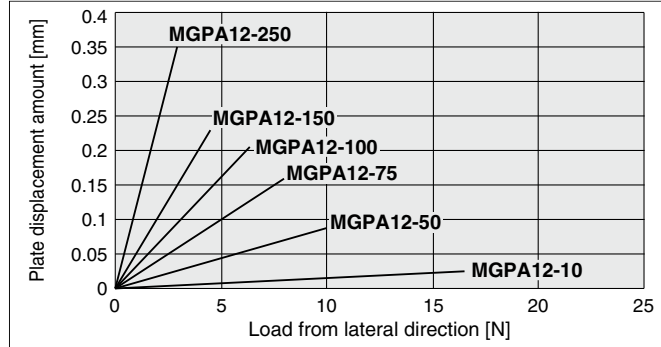

### MGPA32, 40

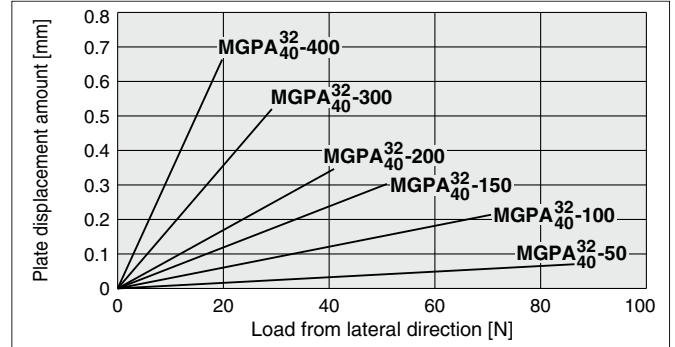

### MGPA16

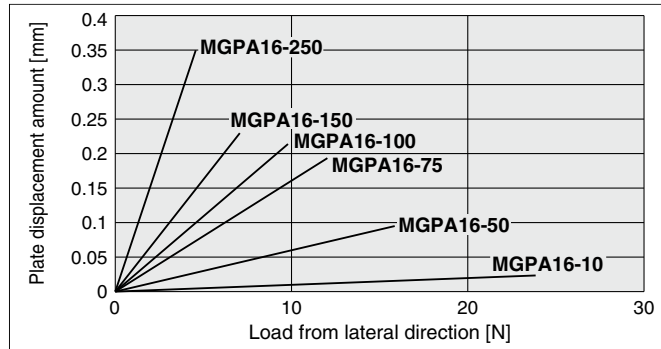

### MGPA50, 63

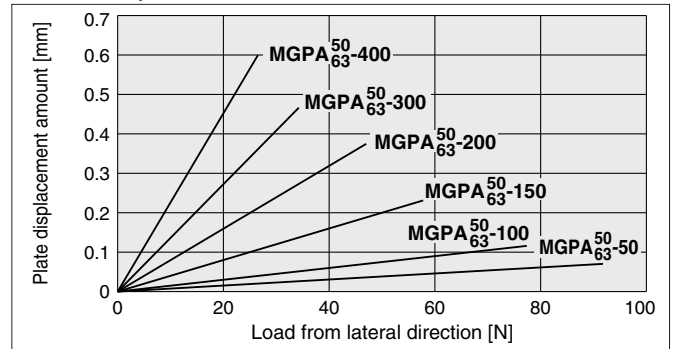

### MGPA20

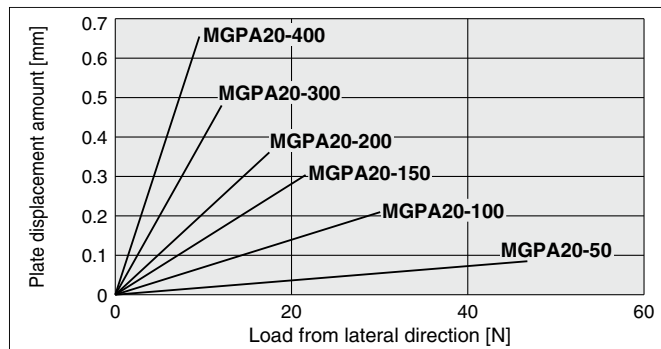

### MGPA80

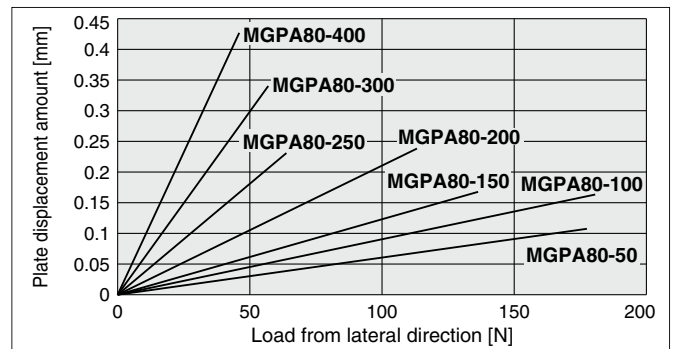

### MGPA25

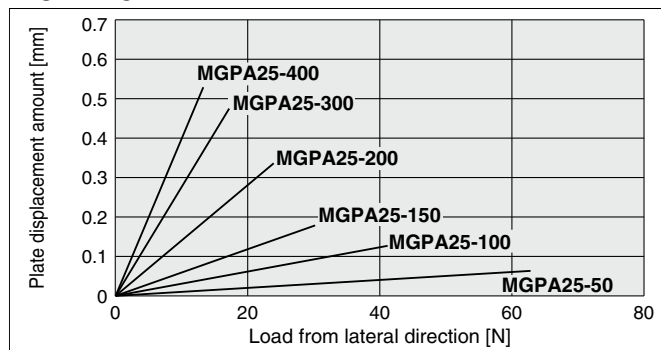

### MGPA100

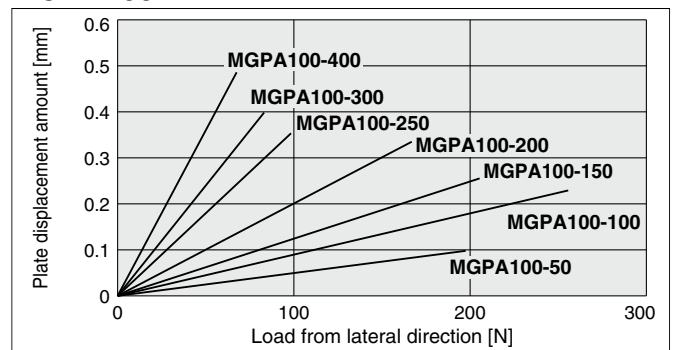

Note 1) The guide rod and self-weight for the plate are not included in the above displacement values.

Note 2) Allowable rotating torque, and operating range when used as a lifter, are the same as those of the MGPL series.

Basic Type **MGP**

With Air Cushion **MGP**

Auto Switch

Made to Order

# Basic Type Series MGP Model Selection

## Selection Conditions

Mounting orientation	Vertical		Horizontal	
Maximum speed (mm/s)	200 or less	400	200 or less	400
Graph (Slide bearing)	(1), (2)	(3), (4)	(13), (14)	(15), (16)
Graph (Ball bushing)	(5) to (8)	(9) to (12)	(17), (18)	(19), (20)

### Selection Example 1 (Vertical Mounting)

#### Selection conditions

Mounting: Vertical  
Bearing type: Ball bushing  
Stroke: 30 stroke  
Maximum speed: 200 mm/s  
Load weight: 3 kg  
Eccentric distance: 90 mm

Find the point of intersection for the load weight of 3 kg and the eccentric distance of 90 mm on graph (5), based on vertical mounting, ball bushing, 30 stroke, and the speed of 200 mm/s.

→ **MGPL25-30Z** is selected.

(5) 30 stroke or less,  $V = 200$  mm/s or less

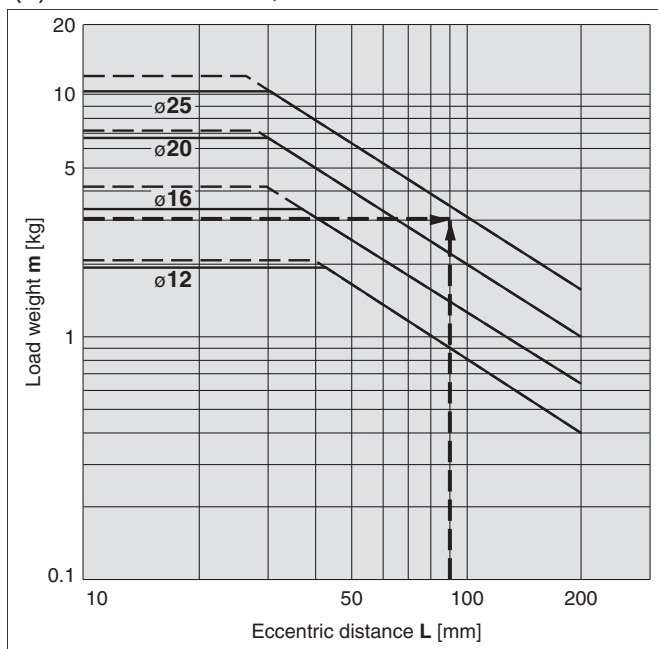

### Selection Example 2 (Horizontal Mounting)

#### Selection conditions

Mounting: Horizontal  
Bearing type: Slide bearing  
Distance between plate and load centre of gravity: 50 mm  
Maximum speed: 200 mm/s  
Load weight: 2 kg  
Stroke: 30 stroke

Find the point of intersection for the load weight of 2 kg and 30 stroke on graph (13), based on horizontal mounting, slide bearing, the distance of 50 mm between the plate and load centre of gravity, and the speed of 200 mm/s.

→ **MGPM20-30Z** is selected.

(13)  $L = 50$  mm,  $V = 200$  mm/s or less

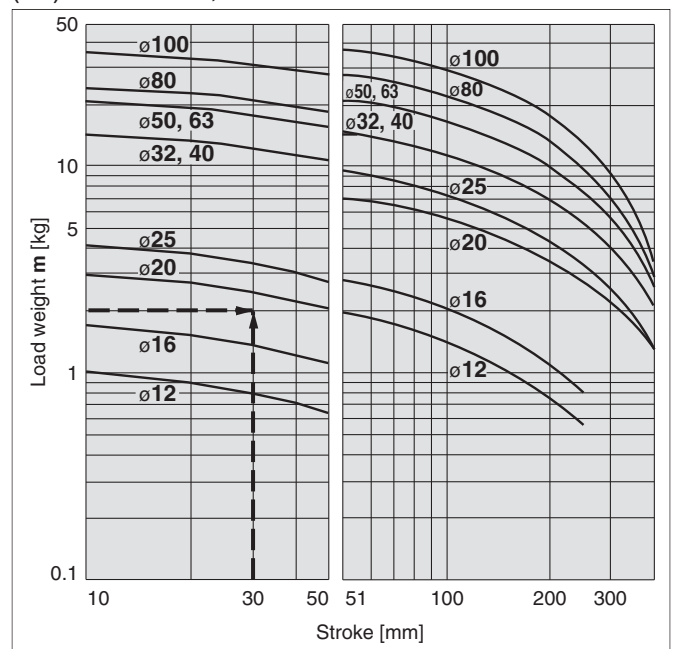

· When the maximum speed exceeds 200 mm/s, the allowable load weight is determined by multiplying the value shown in the graph at 400 mm/s by the coefficient listed in the table below.

Max. speed	Up to 300 mm/s	Up to 400 mm/s	Up to 500 mm/s
Coefficient	1.7	1	0.6

· Use the "Guide Cylinder Selection Software", when the eccentric distance is 200 mm or more.

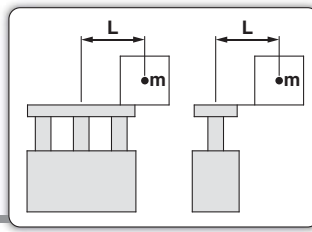

— Operating pressure 0.4 MPa  
 - - - - Operating pressure 0.5 MPa or more

## Vertical Mounting **Slide Bearing**

### MGPM12 to 100

(1) 50 stroke or less,  $V = 200$  mm/s or less

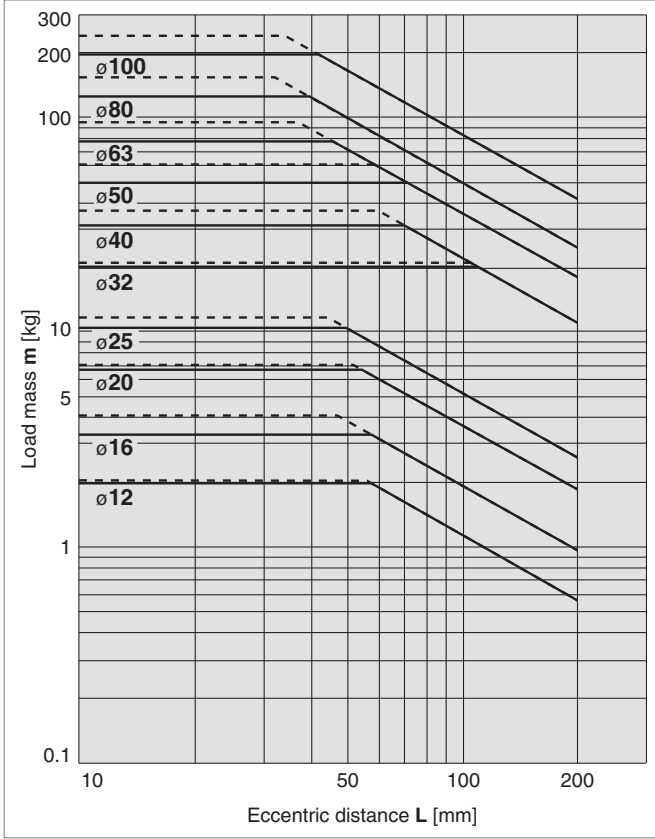

(2) Over 50 stroke,  $V = 200$  mm/s or less

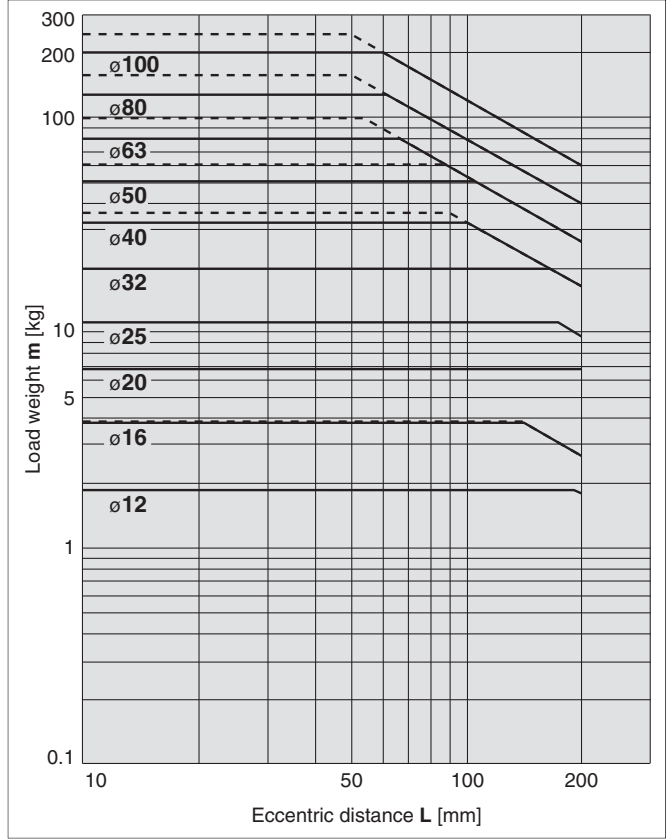

(3) 50 stroke or less,  $V = 400$  mm/s

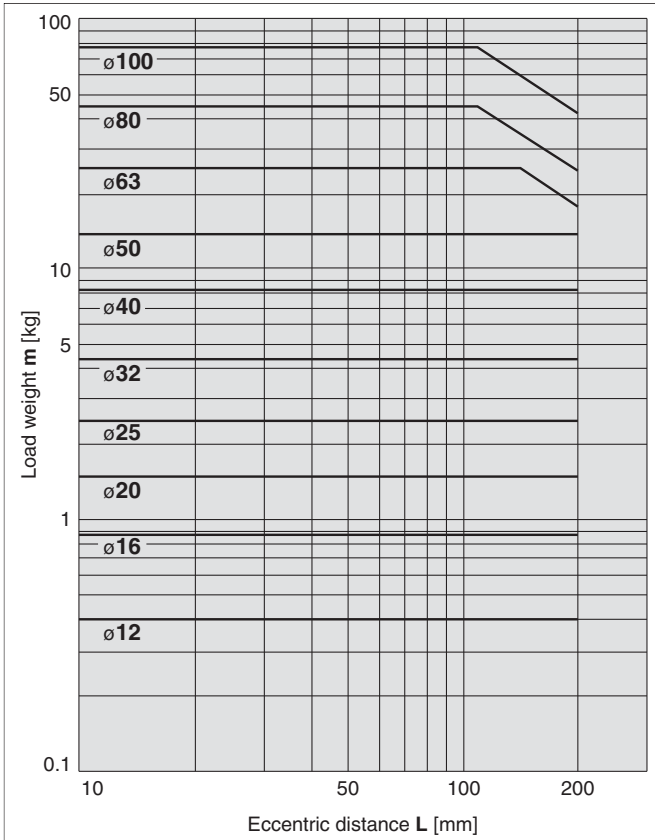

(4) Over 50 stroke,  $V = 400$  mm/s

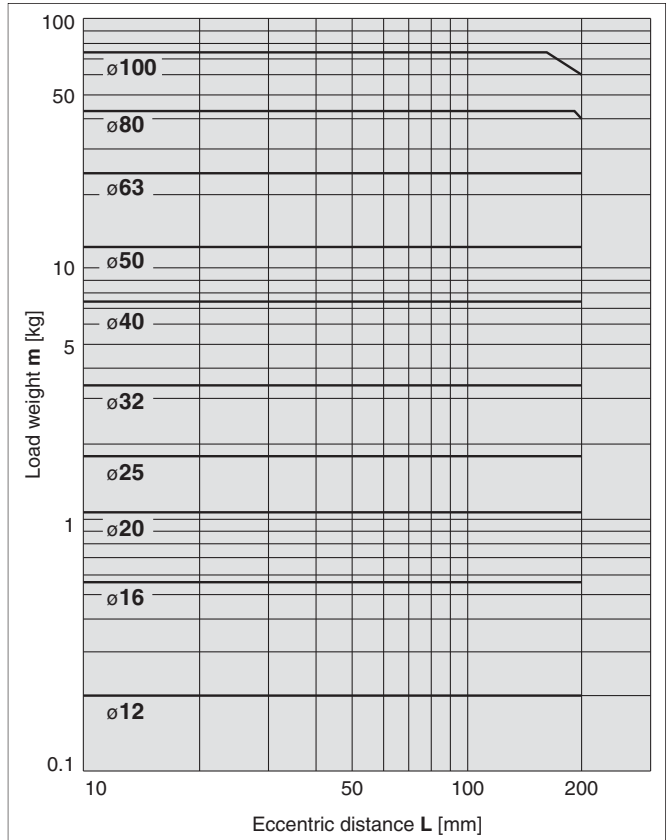

· Use the "Guide Cylinder Selection Software", when the eccentric distance is 200 mm or more.

Basic Type **MGP**

With Air Cushion **MGP**

Auto Switch

Made to Order

# Series MGP

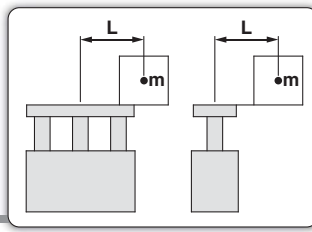

— Operating pressure 0.4 MPa  
 - - - - Operating pressure 0.5 MPa or more

## Vertical Mounting **Ball Bushing**

### MGPL12 to 25, MGPA12 to 25

(5) 30 stroke or less,  $V = 200$  mm/s or less

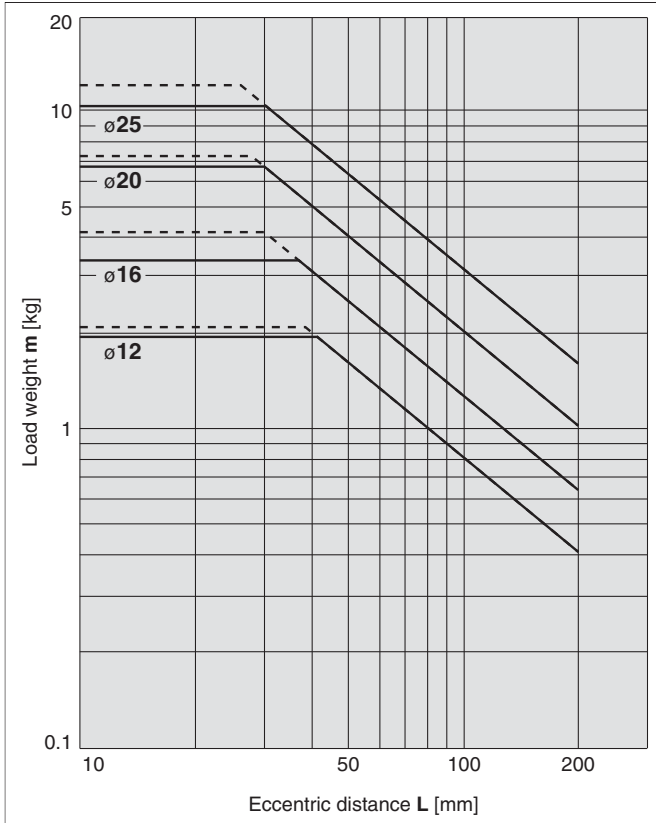

(6) Over 30 stroke,  $V = 200$  mm/s or less

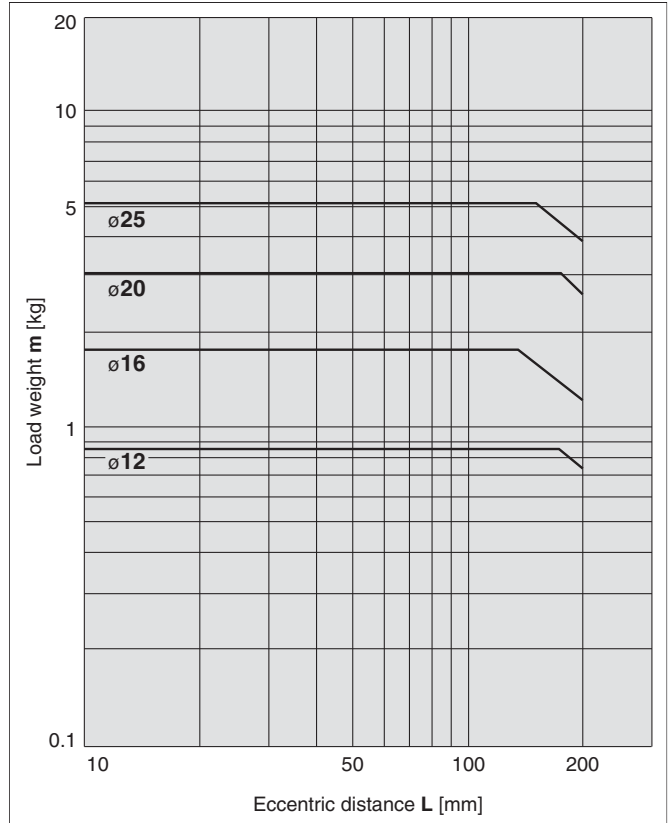

### MGPL32 to 100, MGPA32 to 100

(7) 50 stroke or less,  $V = 200$  mm/s or less

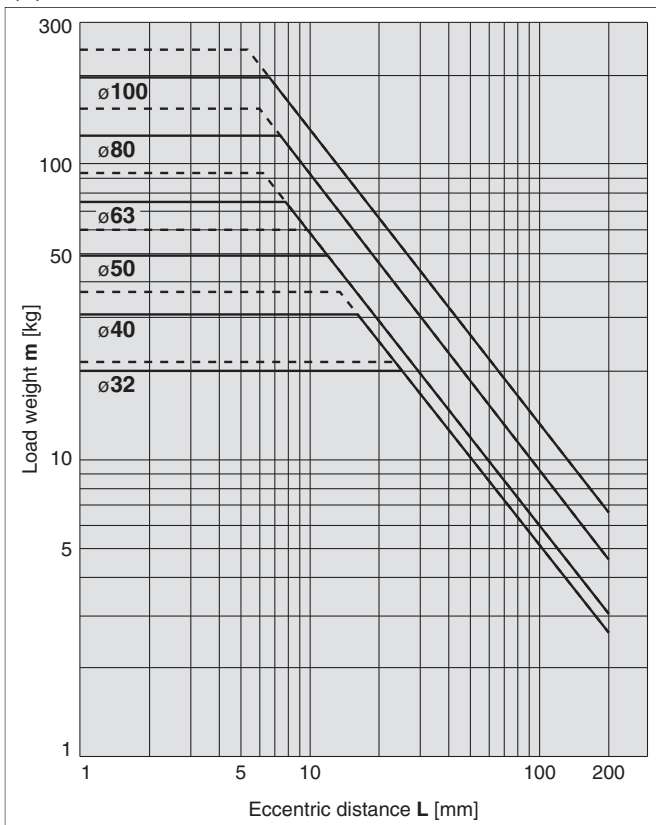

(8) Over 50 stroke,  $V = 200$  mm/s or less

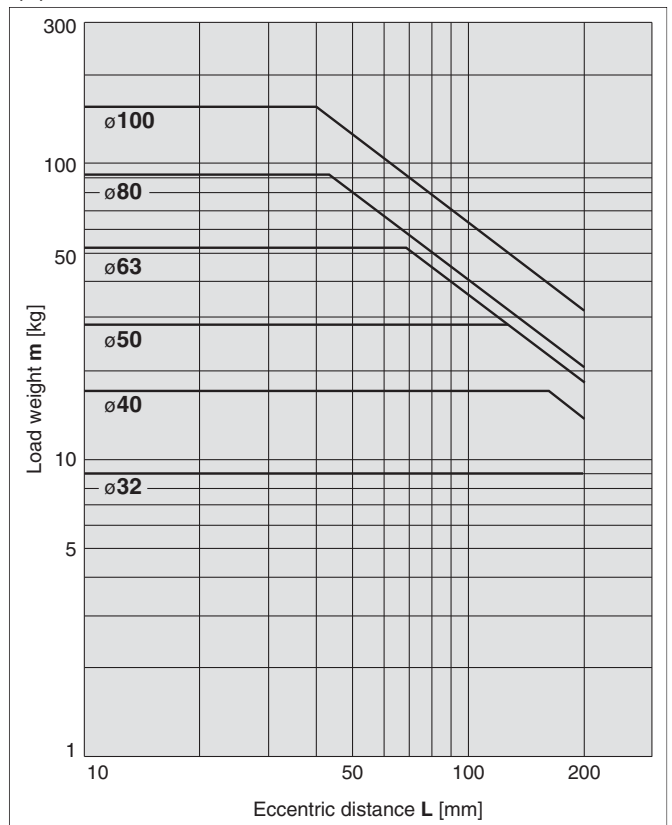

· Use the "Guide Cylinder Selection Software", when the eccentric distance is 200 mm or more.



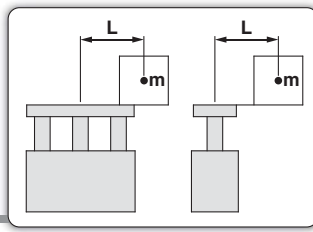

**Vertical Mounting** **Ball Bushing**

Operating pressure 0.4 MPa

**MGPL12 to 25, MGPA12 to 25**

(9) 30 stroke or less, V = 400 mm/s

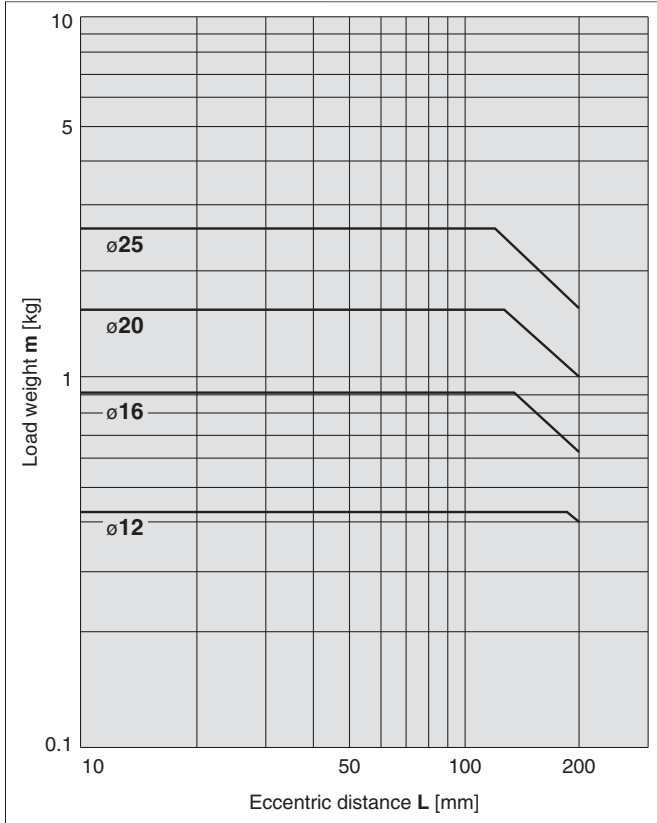

(10) Over 30 stroke, V = 400 mm/s

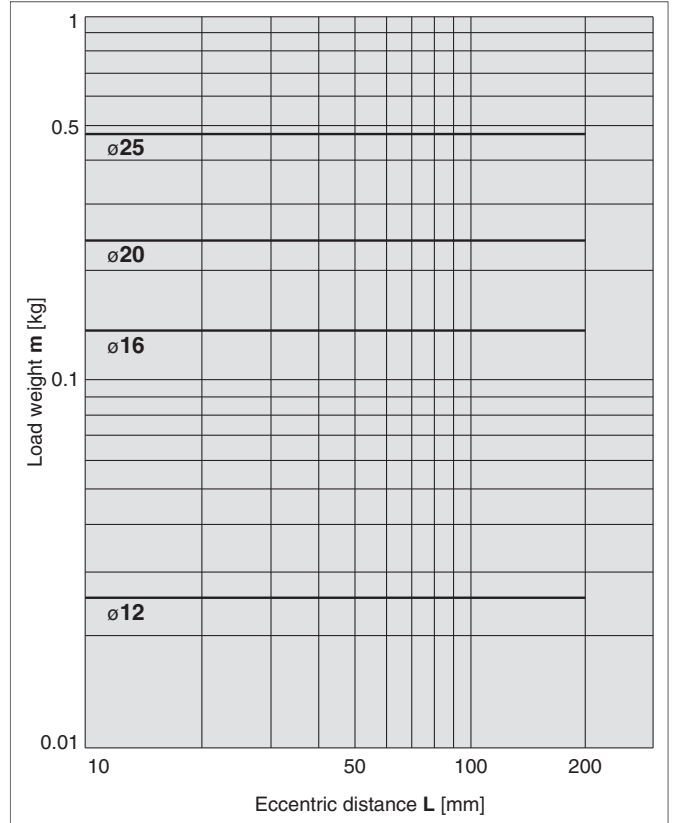

**MGPL32 to 100, MGPA32 to 100**

(11) 50 stroke or less, V = 400 mm/s

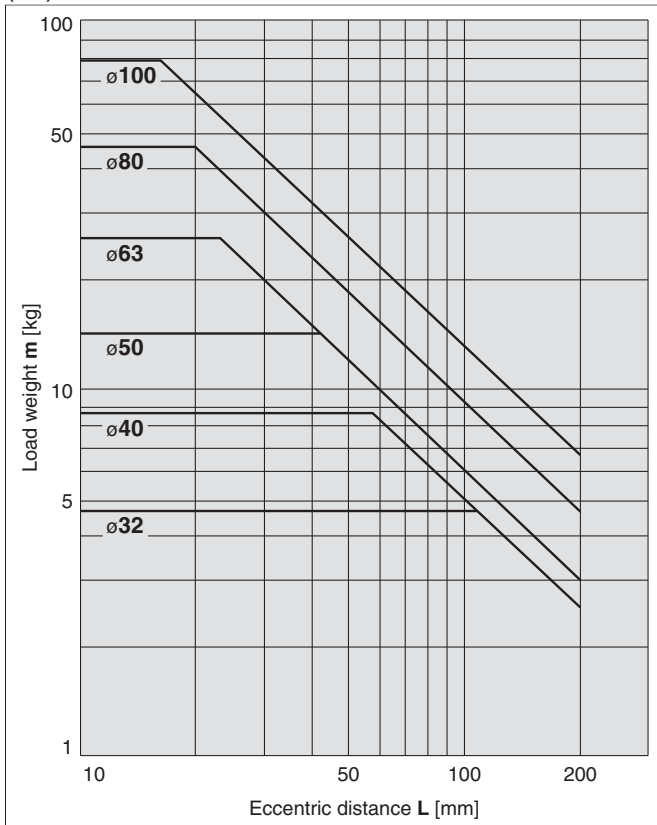

(12) Over 50 stroke, V = 400 mm/s

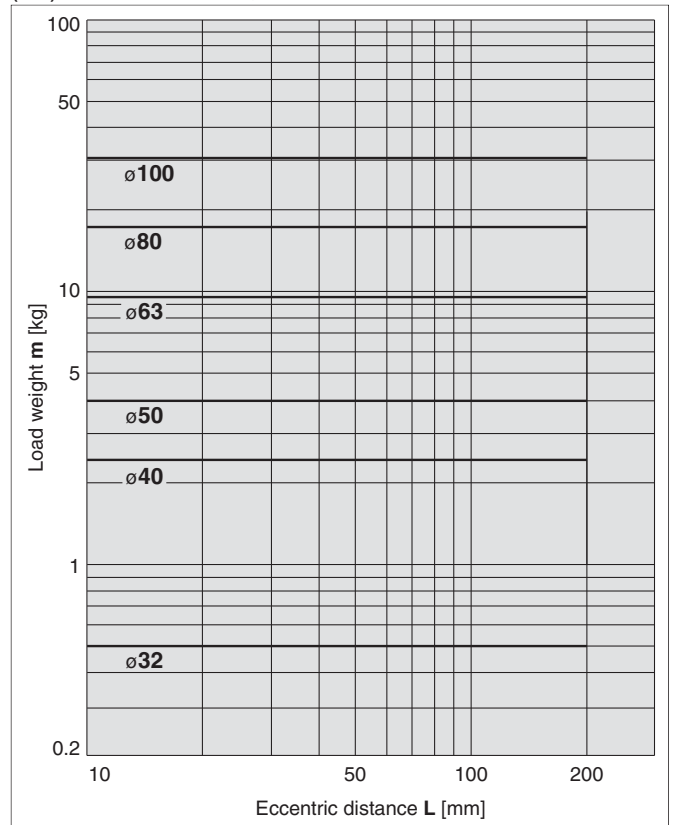

· Use the "Guide Cylinder Selection Software", when the eccentric distance is 200 mm or more.

Basic Type **MGP**

With Air Cushion **MGP**

Auto Switch

Made to Order

# Series MGP

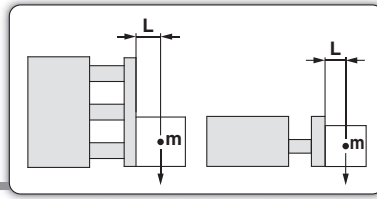

## Horizontal Mounting Slide Bearing

### MGPM12 to 100

(13) L = 50 mm, V = 200 mm/s or less

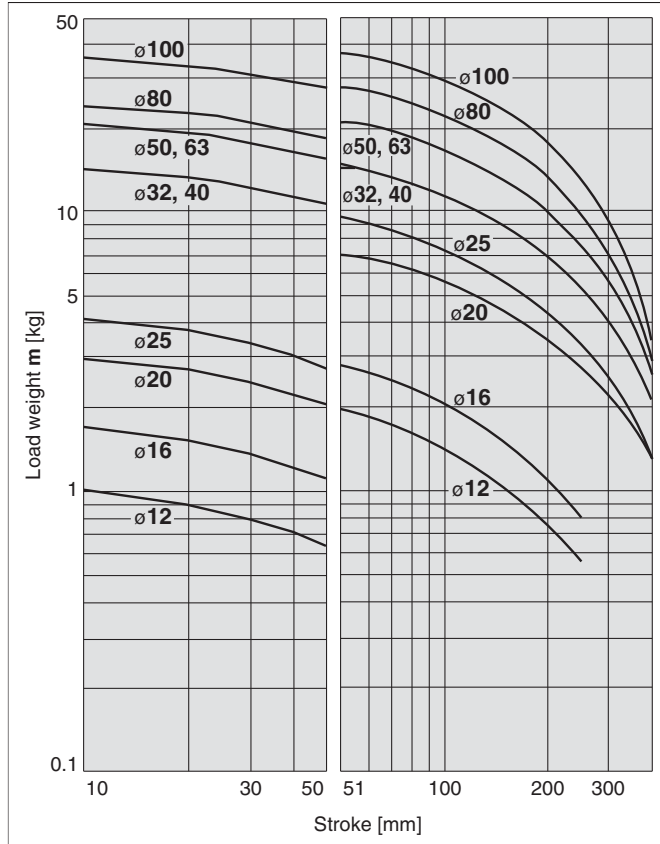

(14) L = 100 mm, V = 200 mm/s or less

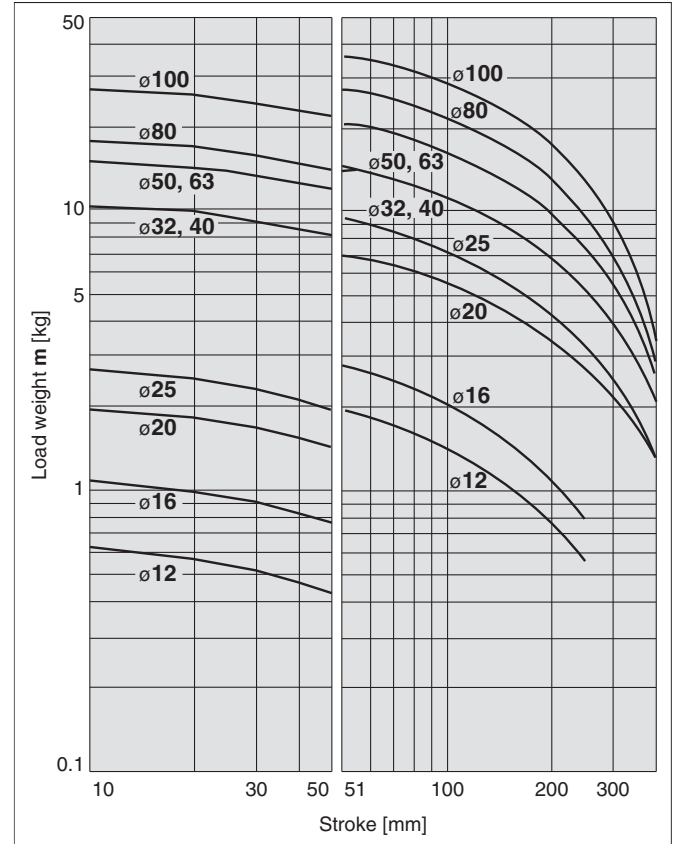

(15) L = 50 mm, V = 400 mm/s

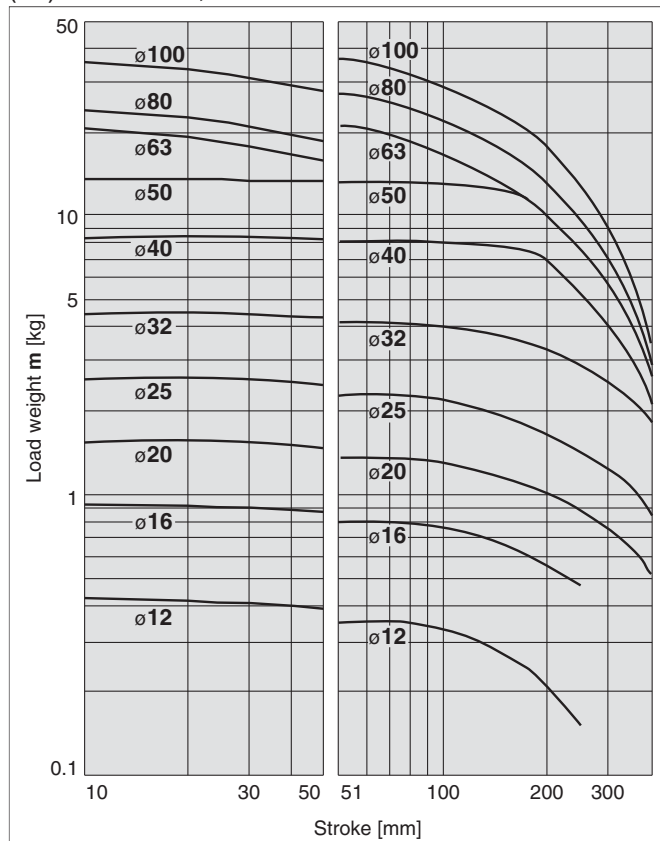

(16) L = 100 mm, V = 400 mm/s

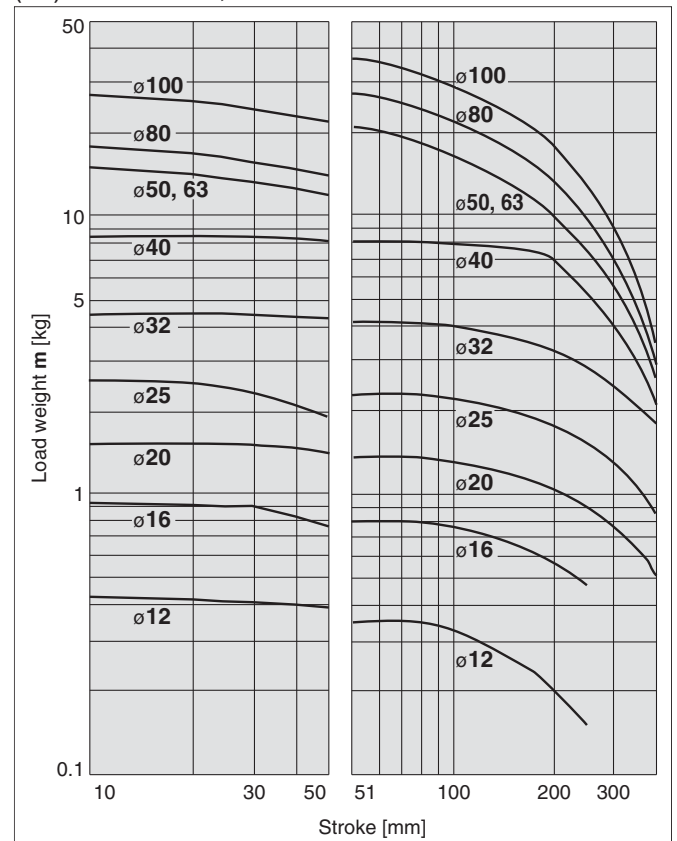

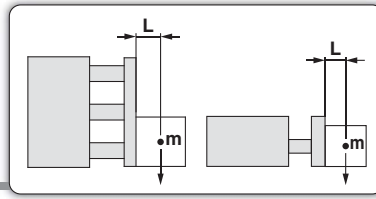

**Horizontal Mounting** **Ball Bushing**

(17) L = 50 mm, V = 200 mm/s or less

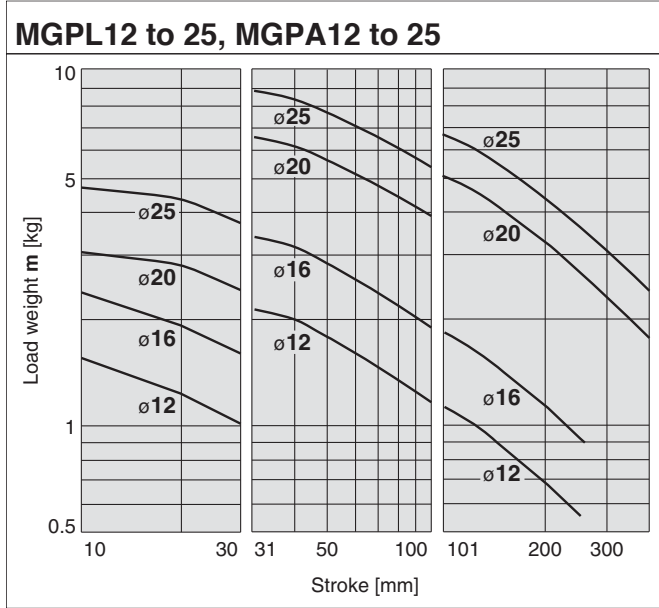

(18) L = 100 mm, V = 200 mm/s or less

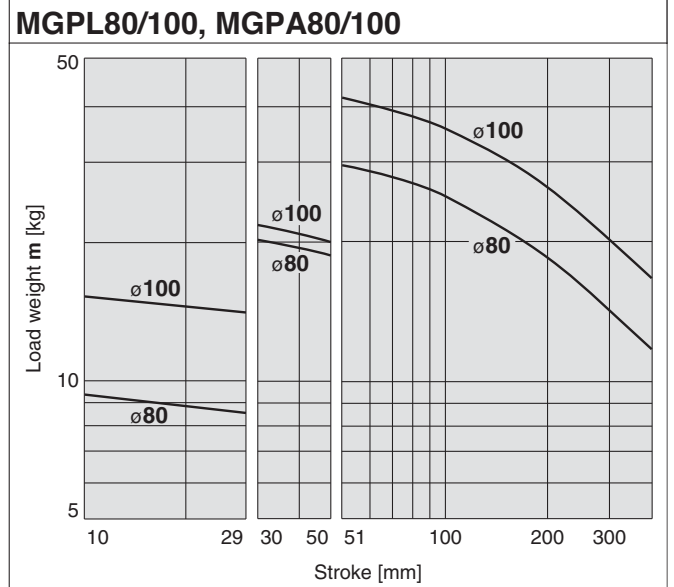
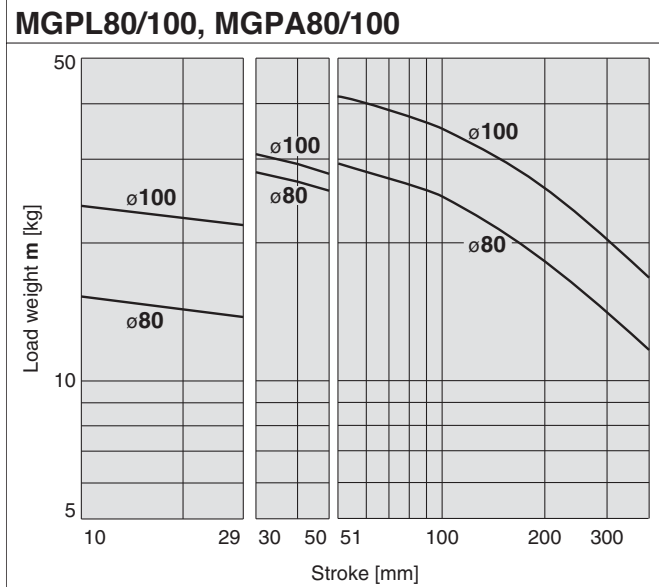
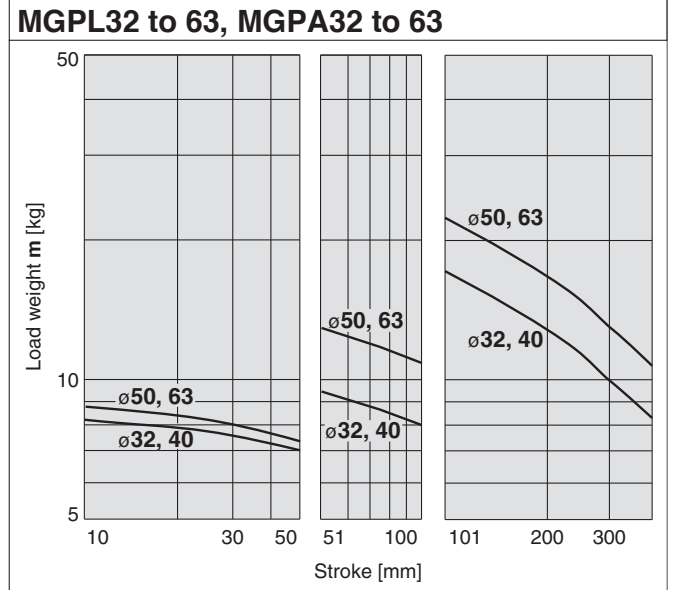
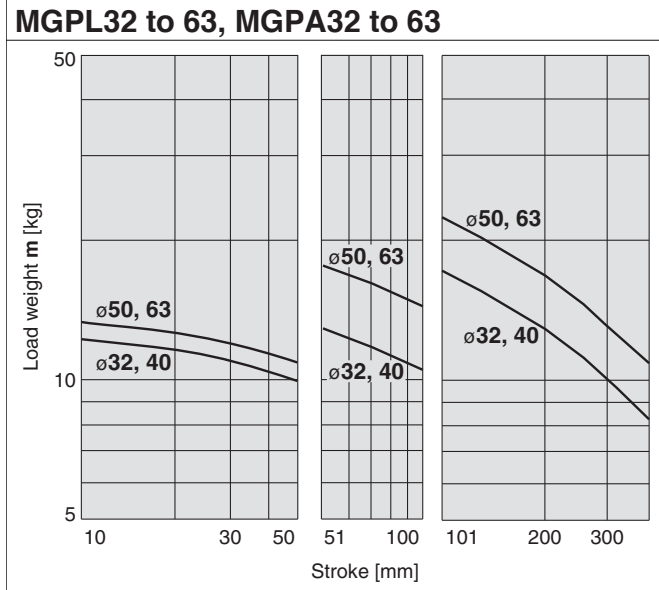
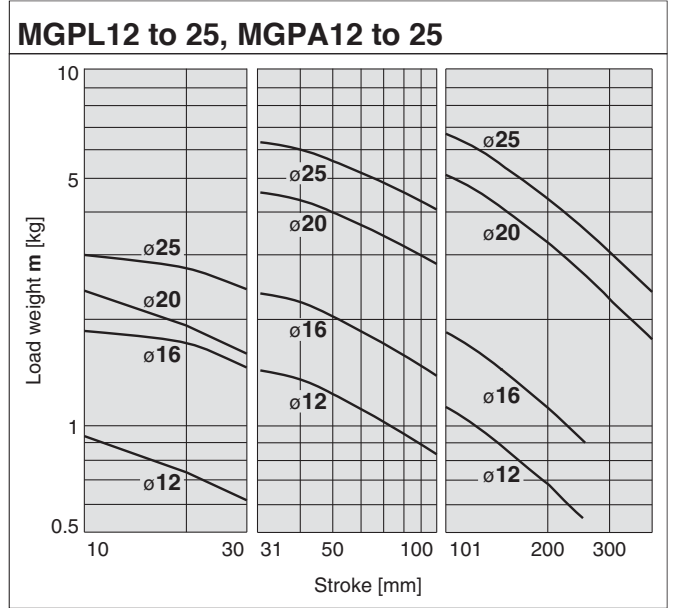

Basic Type **MGP**  
 With Air Cushion **MGP**  
 Auto Switch  
 Made to Order

# Series MGP

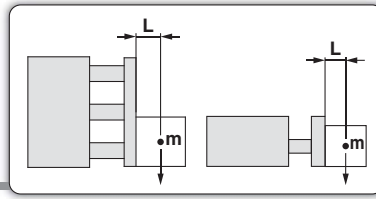

## Horizontal Mounting **Ball Bushing**

(19) L = 50 mm, V = 400 mm/s

(20) L = 100 mm, V = 400 mm/s

### MGPL12 to 25, MGPA12 to 25

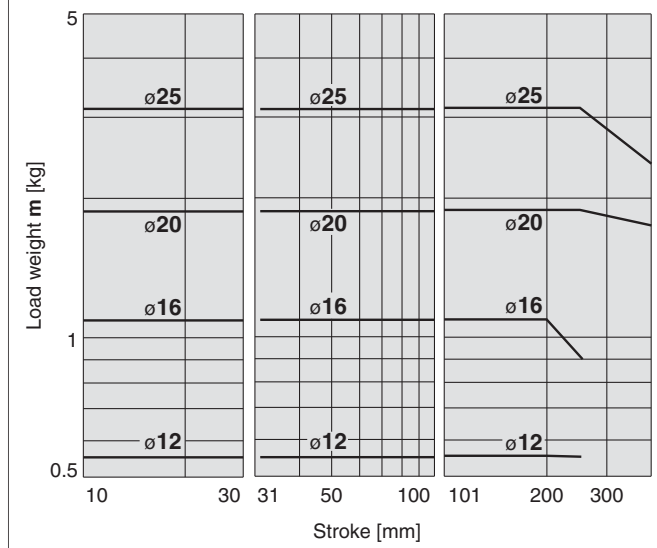

### MGPL12 to 25, MGPA12 to 25

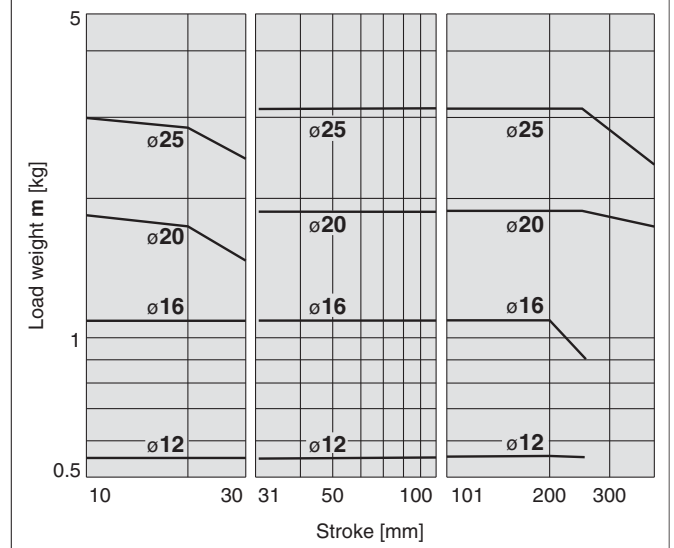

### MGPL32 to 63, MGPA32 to 63

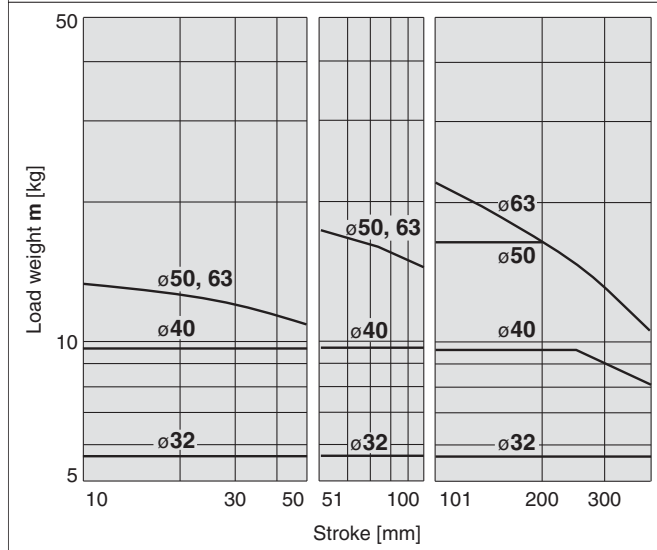

### MGPL32 to 63, MGPA32 to 63

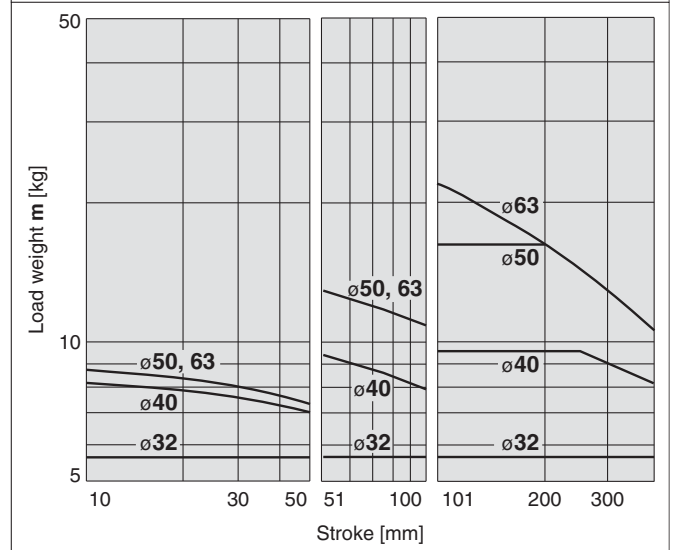

### MGPL80/100, MGPA80/100

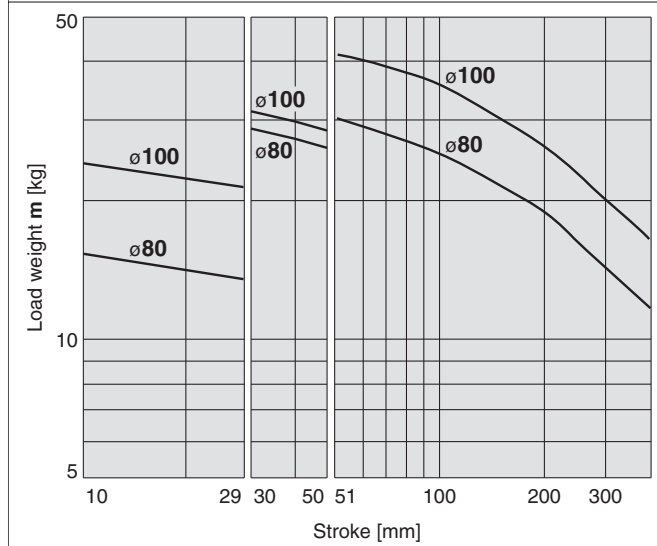

### MGPL80/100, MGPA80/100

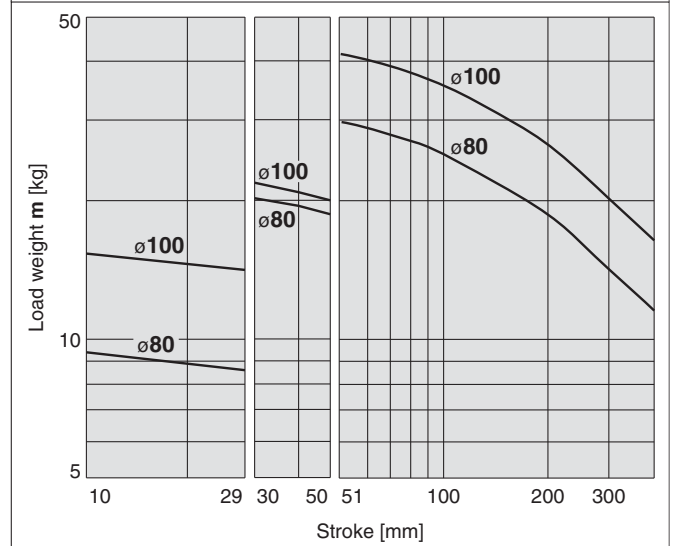

## Operating Range when Used as Stopper

### Bore Size: $\phi 12$ to $\phi 25$ /MGPM12 to 25 (Slide Bearing)

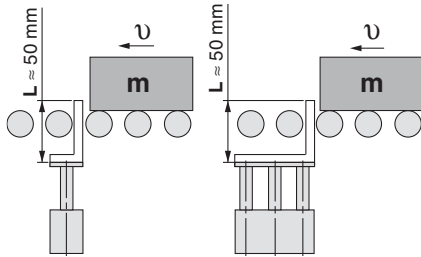

\* When selecting a model with a longer L dimension, be sure to choose a bore size which is sufficiently large.

### ⚠ Caution

#### Caution on handling

- Note 1) When using as a stopper, select a model with 30 stroke or less.
- Note 2) The MGPL (Ball bushing) and the MGPA (High precision ball bushing) cannot be used as a stopper.

#### MGPM12 to 25 (Slide Bearing)

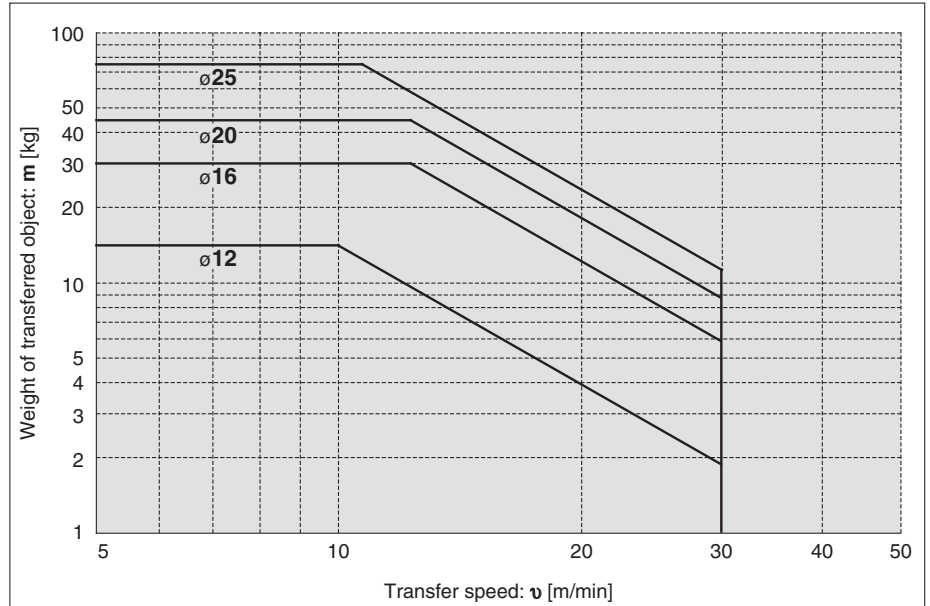

### Bore Size: $\phi 32$ to $\phi 100$ /MGPM32 to 100 (Slide Bearing)

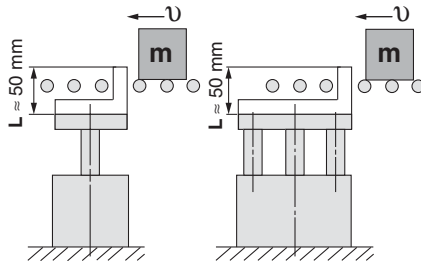

\* When selecting a model with a longer L dimension, be sure to choose a bore size which is sufficiently large.

### ⚠ Caution

#### Caution on handling

- Note 1) When using as a stopper, select a model with 50 stroke or less.
- Note 2) The MGPL (Ball bushing) and the MGPA (High precision ball bushing) cannot be used as a stopper.

#### MGPM32 to 100 (Slide Bearing)

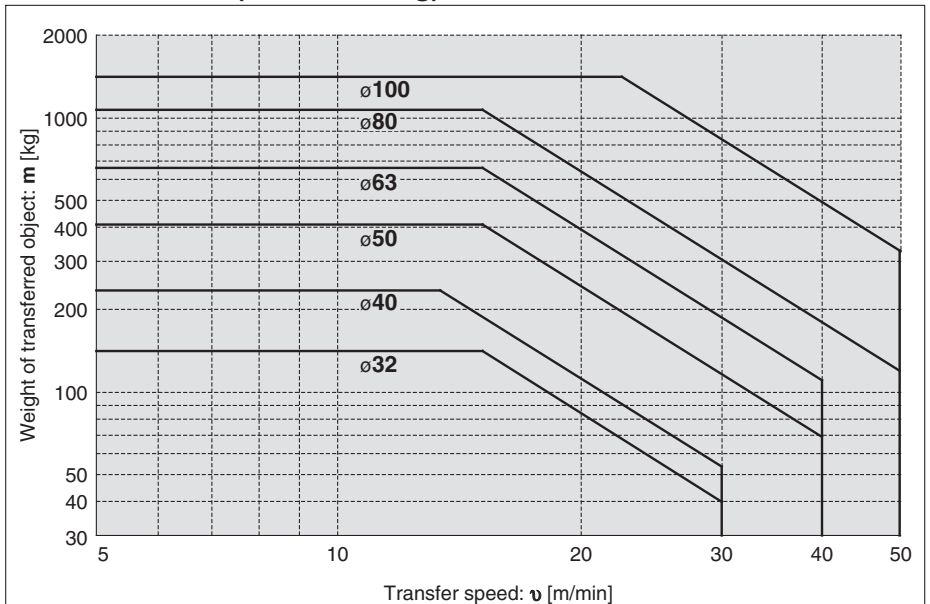

\* Refer to graphs (13) and (15) if line pressure is applied by a roller conveyor after the workpiece is stopped.

Basic Type

MGP

With Air Cushion

MGP

Auto Switch

Made to Order

# Series MGP

## Construction/Series MGPM

### MGPM12 to 25

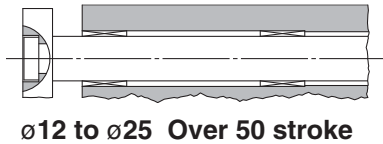
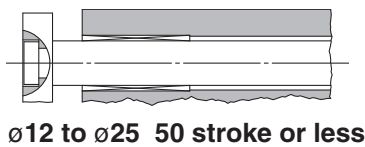
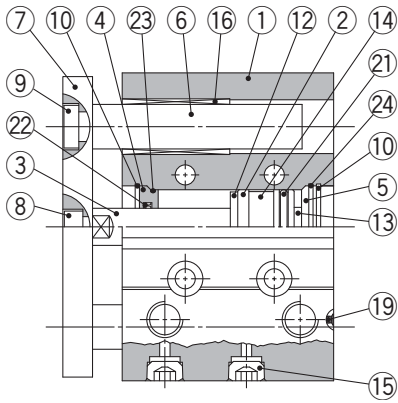

### MGPM32 to 100

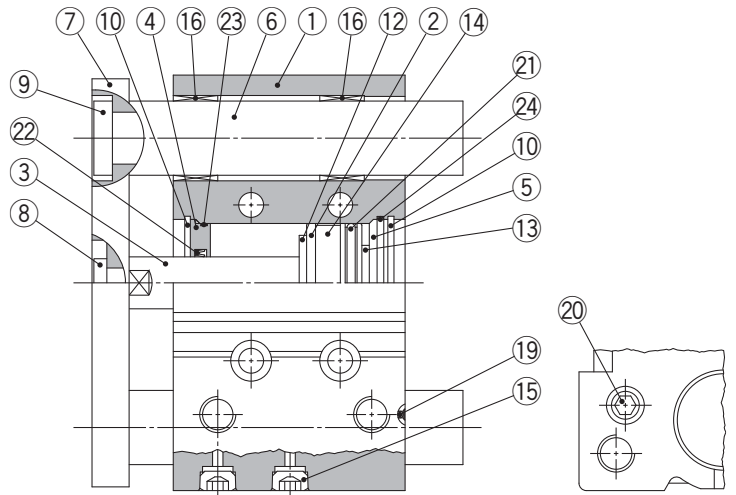

**ø63 or more**

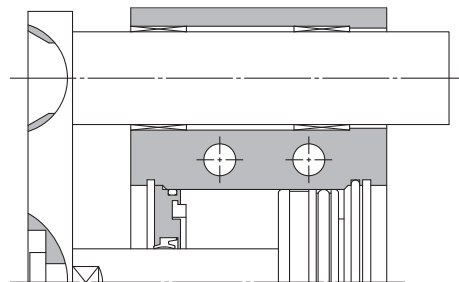

### Component Parts

No.	Description	Material	Note
1	Body	Aluminium alloy	Hard Anodised
2	Piston	Aluminium alloy	Chromated
3	Piston rod	Stainless steel	ø12 to ø25
		Carbon steel	ø32 to ø100 Hard chrome plating
4	Collar	Aluminium alloy	Chromated
5	Head cover	Aluminium alloy	ø12 to ø63 Chromated
			ø80, ø100 Painted
6	Guide rod	Carbon steel	Hard chrome plating
7	Plate	Carbon steel	Nickel plating
8	Plate mounting bolt	Carbon steel	Nickel plating
9	Guide bolt	Carbon steel	Nickel plating
10	Retaining ring	Carbon tool steel	Phosphate coated
11	Retaining ring	Carbon tool steel	Phosphate coated
12	Bumper A	Urethane	
13	Bumper B	Urethane	
14	Magnet	—	
15	Plug Hexagon socket head plug	Carbon steel	ø12, ø16 Nickel plating
			ø20 to ø100
16	Slide bearing	Bearing alloy	

### Component Parts

No.	Description	Material	Note
17	Ball bushing		
18	Spacer	Aluminium alloy	
19	Steel ball	Carbon steel	ø12 to ø50
20	Plug	Carbon steel	ø63 to ø100 Nickel plating
21*	Piston seal	NBR	
22*	Rod seal	NBR	
23*	Gasket A	NBR	
24*	Gasket B	NBR	

### Replacement Parts/Seal Kit

Bore size [mm]	Kit no.	Contents	Bore size [mm]	Kit no.	Contents
12	MGP12-Z-PS	Set of nos. above	40	MGP40-Z-PS	Set of nos. above
16	MGP16-Z-PS		50	MGP50-Z-PS	
20	MGP20-Z-PS		63	MGP63-Z-PS	
25	MGP25-Z-PS		80	MGP80-Z-PS	
32	MGP32-Z-PS		100	MGP100-Z-PS	

\* Seal kit includes ⑳ to ㉔. Order the seal kit, based on each bore size.

\* Since the seal kit does not include a grease pack, order it separately.

**Grease pack part number: GR-S-010 (10 g)**

**Construction/Series MGPL, Series MGPA**

**MGPL12 to 25**  
**MGPA12 to 25**

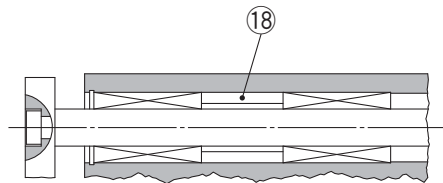
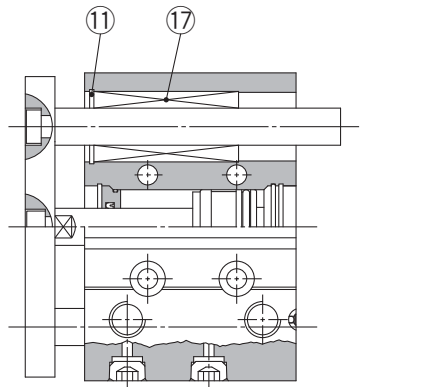

**ø12 to ø25 Over 100 stroke**

**MGPL32 to 100**  
**MGPA32 to 100**

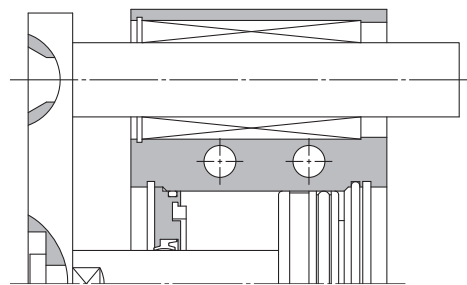
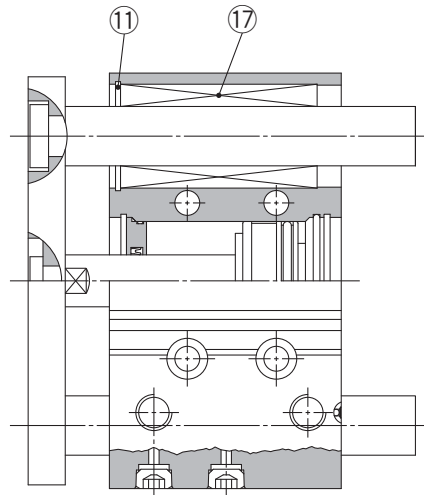

**ø50 or more**

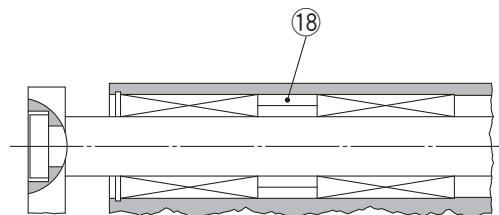

**ø32 to ø63 Over 100 stroke**  
**ø80, ø100 Over 200 stroke**

Basic Type

**MGP**

With Air Cushion

**MGP**

Auto Switch

Made to Order

# Series MGP

## Ø12 to Ø25/MGPM, MGPL, MGPA

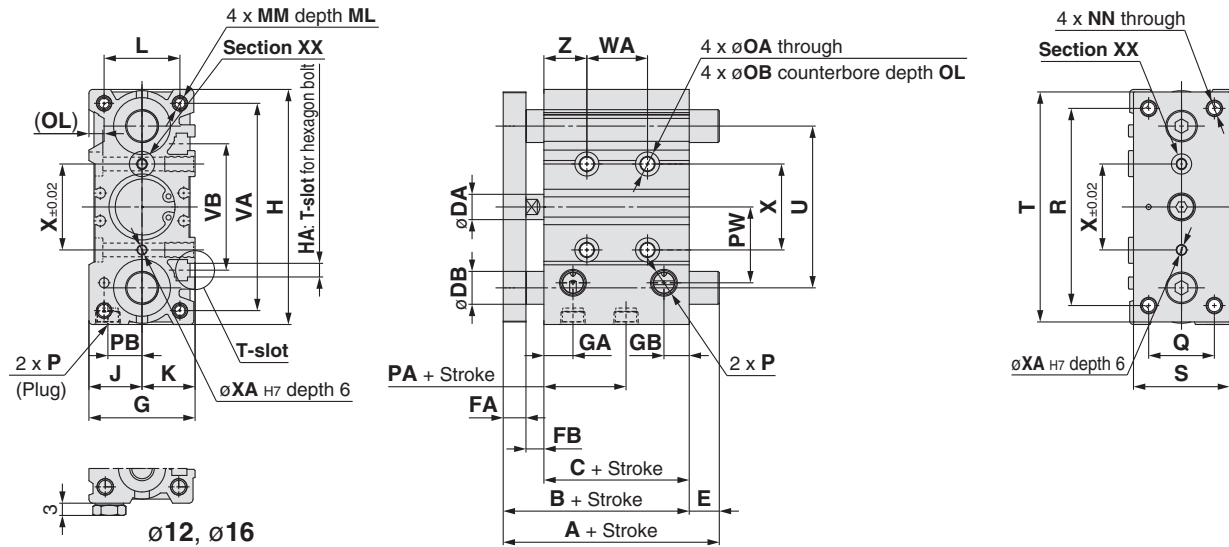
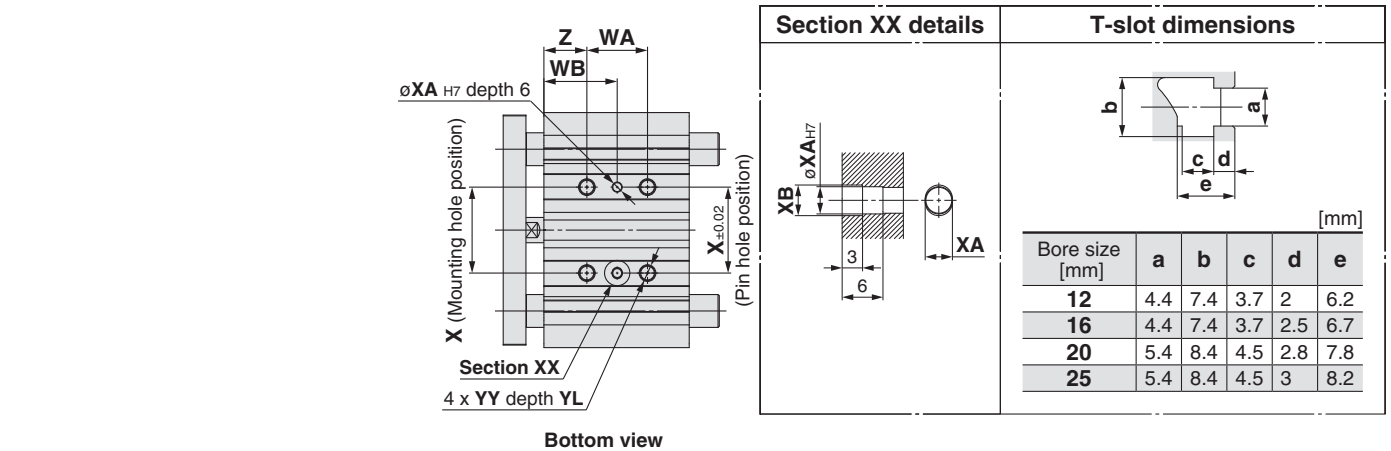

- \* The use of a slot (width XA, length XB, depth 3) allows for a relaxed pin pitch tolerance, with the pin hole (ØXA<sub>H7</sub>, depth 6) as the reference, without affecting mounting accuracy.
- \* For intermediate strokes other than standard strokes, refer to "Manufacture of Intermediate Strokes" on page 4.
- \* For bore size Ø12 and Ø16, only M5 x 0.8 port is available.
- \* For bore size Ø20 or more, choice of Rc, NPT, G port is available. (Refer to page 3.)

### MGPM, MGPL, MGPA Common Dimensions

Bore size [mm]	Standard stroke [mm]	B	C	DA	FA	FB	G	GA	GB	H	HA	J	K	L	MM	ML	NN	OA	OB	OL	P		
																					—	TN	TF
12	10, 20, 30, 40, 50, 75, 100	42	29	6	7	6	26	10	7	58	M4	13	13	18	M4 x 0.7	10	M4 x 0.7	4.3	8	4.5	M5 x 0.8	—	—
16	125, 150, 175, 200, 250	46	33	8	7	6	30	10.5	7.5	64	M4	15	15	22	M5 x 0.8	12	M5 x 0.8	4.3	8	4.5	M5 x 0.8	—	—
20	20, 30, 40, 50, 75, 100, 125, 150	53	37	10	8	8	36	11.5	9	83	M5	18	18	24	M5 x 0.8	13	M5 x 0.8	5.4	9.5	5.5	Rc1/8	NPT1/8	G1/8
25	175, 200, 250, 300, 350, 400	53.5	37.5	10	9	7	42	11.5	10	93	M5	21	21	30	M6 x 1.0	15	M6 x 1.0	5.4	9.5	5.5	Rc1/8	NPT1/8	G1/8

Bore size [mm]	PA	PB	PW	Q	R	S	T	U	VA	VB	WA				WB				X	XA	XB	YY	YL	Z		
											30 st or less	Over 30 st 100 st or less	Over 100 st 200 st or less	Over 200 st 300 st or less	30 st or less	Over 30 st 100 st or less	Over 100 st 200 st or less	Over 200 st 300 st or less								
12	13	8	18	14	48	22	56	41	50	37	20	40	110	200	—	15	25	60	105	—	23	3	3.5	M5 x 0.8	10	5
16	14.5	10	19	16	54	25	62	46	56	38	24	44	110	200	—	17	27	60	105	—	24	3	3.5	M5 x 0.8	10	5
20	13.5	10.5	25	18	70	30	81	54	72	44	24	44	120	200	300	29	39	77	117	167	28	3	3.5	M6 x 1.0	12	17
25	12.5	13.5	30	26	78	38	91	64	82	50	24	44	120	200	300	29	39	77	117	167	34	4	4.5	M6 x 1.0	12	17

### MGPM (Slide bearing) A, DB, E Dimensions

Bore size [mm]	A				DB	E			
	50 st or less	Over 50 st 100 st or less	Over 100 st 200 st or less	Over 200 st		50 st or less	Over 50 st 100 st or less	Over 100 st 200 st or less	Over 200 st
12	42	60.5	82.5	82.5	8	0	18.5	40.5	40.5
16	46	64.5	92.5	92.5	10	0	18.5	46.5	46.5
20	53	77.5	77.5	110	12	0	24.5	24.5	57
25	53.5	77.5	77.5	109.5	16	0	24	24	56

### MGPL (Ball bushing)

### MGPA (High precision ball bushing) A, DB, E Dimensions

Bore size [mm]	A				DB	E			
	30 st or less	Over 30 st 100 st or less	Over 100 st 200 st or less	Over 200 st		30 st or less	Over 30 st 100 st or less	Over 100 st 200 st or less	Over 200 st
12	43	55	84.5	84.5	6	1	13	42.5	42.5
16	49	65	94.5	94.5	8	3	19	48.5	48.5
20	59	76	100	117.5	10	6	23	47	64.5
25	65.5	81.5	100.5	117.5	13	12	28	47	64



**∅32 to ∅63/MGPM, MGPL, MGPA**

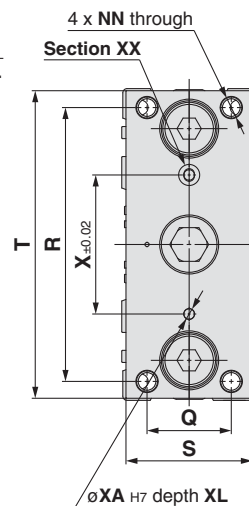
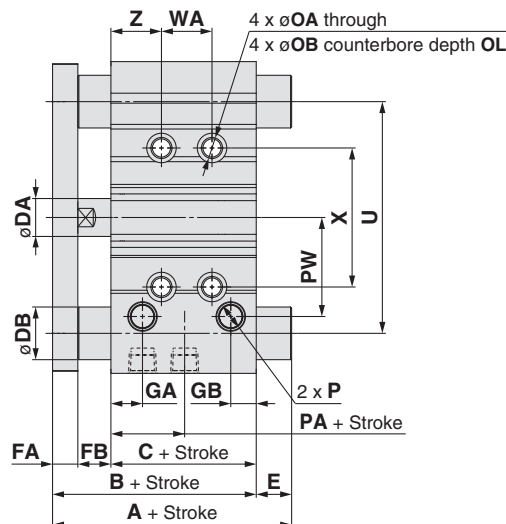
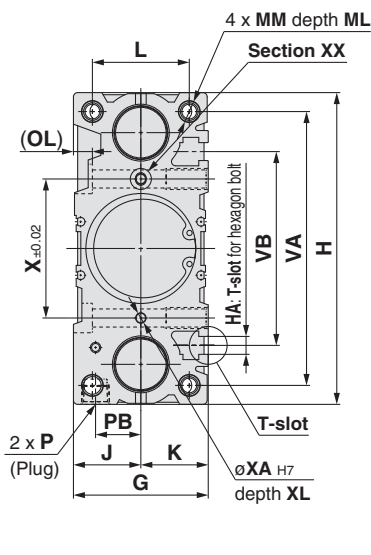
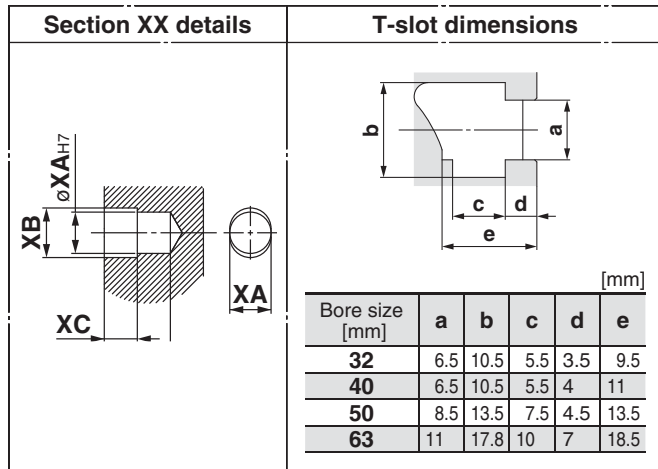
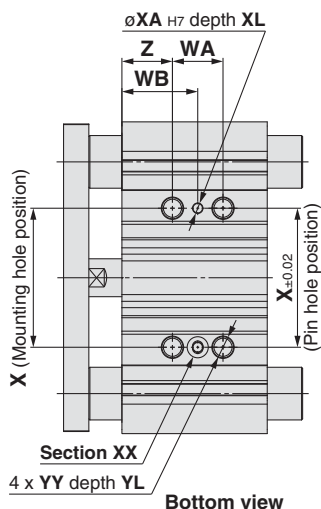

- \* The use of a slot (width XA, length XB, depth XC) allows for a relaxed pin pitch tolerance, with the pin hole (∅XA<sub>H7</sub>, depth XL) as the reference, without affecting mounting accuracy.
- \* For intermediate strokes other than standard strokes, refer to "Manufacture of Intermediate Strokes" on page 4.
- \* Choice of Rc, NPT, G port is available. (Refer to page 3.)

**MGPM, MGPL, MGPA Common Dimensions**

Bore size [mm]	Standard stroke [mm]	B	C	DA	FA	FB	G	GA	GB	H	HA	J	K	L	MM	ML	NN	OA	OB	OL	P		
																					—	TN	TF
32	25, 50, 75	59.5	37.5	14	10	12	48	12	9	112	M6	24	24	34	M8 x 1.25	20	M8 x 1.25	6.7	11	7.5	Rc1/8	NPT1/8	G1/8
40	100, 125, 150	66	44	14	10	12	54	15	12	120	M6	27	27	40	M8 x 1.25	20	M8 x 1.25	6.7	11	7.5	Rc1/8	NPT1/8	G1/8
50	175, 200, 250	72	44	18	12	16	64	15	12	148	M8	32	32	46	M10 x 1.5	22	M10 x 1.5	8.6	14	9	Rc1/4	NPT1/4	G1/4
63	300, 350, 400	77	49	18	12	16	78	15.5	13.5	162	M10	39	39	58	M10 x 1.5	22	M10 x 1.5	8.6	—	9	Rc1/4	NPT1/4	G1/4

Bore size [mm]	PA	PB	PW	Q	R	S	T	U	VA	VB	WA					WB					X	XA	XB	XC	XL	YY	YL	Z
											25 st or less	Over 25 st 100 st or less	Over 100 st 200 st or less	Over 200 st 300 st or less	Over 300 st	25 st or less	Over 25 st 100 st or less	Over 100 st 200 st or less	Over 200 st 300 st or less	Over 300 st								
32	6.5	16	35.5	30	96	44	110	78	98	63	24	48	124	200	300	33	45	83	121	171	42	4	4.5	3	6	M8 x 1.25	16	21
40	13	18	39.5	30	104	44	118	86	106	72	24	48	124	200	300	34	46	84	122	172	50	4	4.5	3	6	M8 x 1.25	16	22
50	9	21.5	47	40	130	60	146	110	130	92	24	48	124	200	300	36	48	86	124	174	66	5	6	4	8	M10 x 1.5	20	24
63	13	28	58	50	130	70	158	124	142	110	28	52	128	200	300	38	50	88	124	174	80	5	6	4	8	M10 x 1.5	20	24

**MGPM (Slide bearing) A, DB, E Dimensions**

Bore size [mm]	A			DB	E		
	50 st or less	Over 50 st 200 st or less	Over 200 st		50 st or less	Over 50 st 200 st or less	Over 200 st
32	75	93.5	129.5	20	15.5	34	70
40	75	93.5	129.5	20	9	27.5	63.5
50	88.5	109.5	150.5	25	16.5	37.5	78.5
63	88.5	109.5	150.5	25	11.5	32.5	73.5

**MGPL (Ball bushing)**

**MGPA (High precision ball bushing) A, DB, E Dimensions**

Bore size [mm]	A				DB	E			
	50 st or less	Over 50 st 100 st or less	Over 100 st 200 st or less	Over 200 st		50 st or less	Over 50 st 100 st or less	Over 100 st 200 st or less	Over 200 st
32	79.5	96.5	116.5	138.5	16	20	37	57	79
40	79.5	96.5	116.5	138.5	16	13.5	30.5	50.5	72.5
50	91.5	112.5	132.5	159.5	20	19.5	40.5	60.5	87.5
63	91.5	112.5	132.5	159.5	20	14.5	35.5	55.5	82.5

Basic Type **MGP**

With Air Cushion **MGP**

Auto Switch

Made to Order

# Series MGP

## ∅80, ∅100/MGPM, MGPL, MGPA

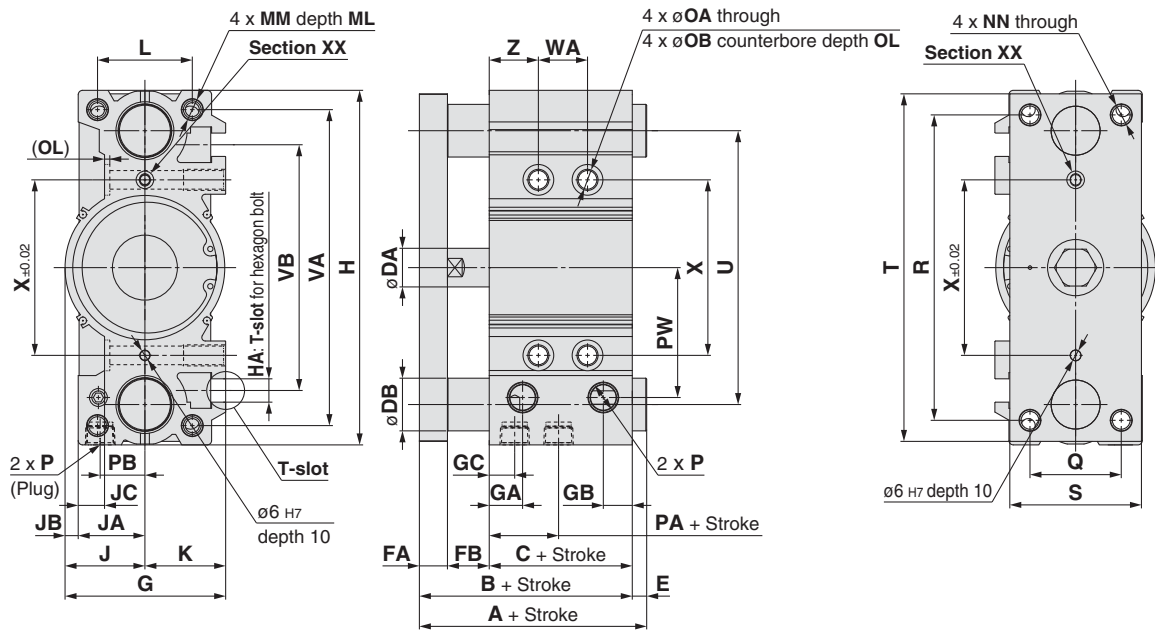
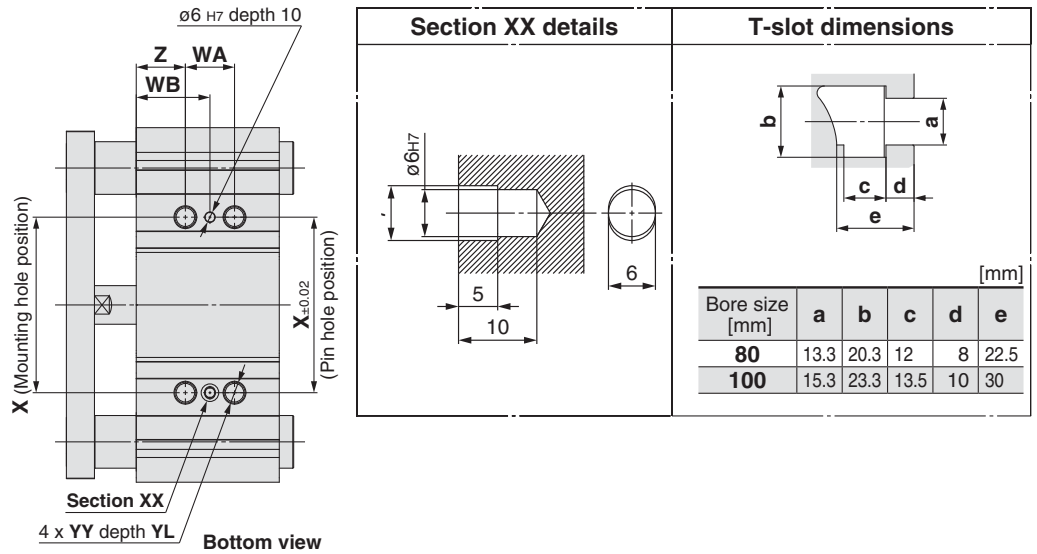

- \* The use of a slot (width X6, length 7, depth 5) allows for a relaxed pin pitch tolerance, with the pin hole (∅6H7, depth 10) as the reference, without affecting mounting accuracy.
- \* For intermediate strokes other than standard strokes, refer to "Manufacture of Intermediate Strokes" on page 4.
- \* Choice of Rc, NPT, G port is available. (Refer to page 3.)

### MGPM, MGPL, MGPA Common Dimensions

Bore size [mm]	Standard stroke [mm]	B	C	DA	FA	FB	G	GA	GB	GC	H	HA	J	JA	JB	JC	K	L	MM	ML	NN	OA	OB	OL	P		
																									Nil	TN	TF
80	25, 50, 75, 100	96.5	56.5	22	16	24	91.5	19	16.5	14.5	202	M12	45.5	38	7.5	15	46	54	M12 x 1.75	25	M12 x 1.75	10.6	17.5	3	Rc3/8	NPT3/8	G3/8
	125, 150, 175, 200	116	66	26	19	31	111.5	22.5	20.5	18	240	M14	55.5	45	10.5	10	56	62	M14 x 2.0	31	M14 x 2.0	12.5	20	8	Rc3/8	NPT3/8	G3/8
100	250, 300, 350, 400	116	66	26	19	31	111.5	22.5	20.5	18	240	M14	55.5	45	10.5	10	56	62	M14 x 2.0	31	M14 x 2.0	12.5	20	8	Rc3/8	NPT3/8	G3/8

Bore size [mm]	PA	PB	PW	Q	R	S	T	U	VA	VB	WA					WB					X	YY	YL	Z
											25 st or less	Over 25 st 100 st or less	Over 100 st 200 st or less	Over 200 st 300 st or less	Over 300 st	25 st or less	Over 25 st 100 st or less	Over 100 st 200 st or less	Over 200 st 300 st or less	Over 300 st				
80	14.5	25.5	74	52	174	75	198	156	180	140	28	52	128	200	300	42	54	92	128	178	100	M12 x 1.75	24	28
100	17.5	32.5	89	64	210	90	236	188	210	166	48	72	148	220	320	35	47	85	121	171	124	M14 x 2.0	28	11

### MGPM (Slide bearing) A, DB, E Dimensions

Bore size [mm]	A			DB	E		
	50 st or less	Over 50 st 200 st or less	Over 200 st		50 st or less	Over 50 st 200 st or less	Over 200 st
80	104.5	131.5	180.5	30	8	35	84
100	126.5	151.5	190.5	36	10.5	35.5	74.5

### MGPL (Ball bushing)

### MGPA (High precision ball bushing) A, DB, E Dimensions

Bore size [mm]	A				DB	E			
	25 st or less	Over 25 st 50 st or less	Over 50 st 200 st or less	Over 200 st		25 st or less	Over 25 st 50 st or less	Over 50 st 200 st or less	Over 200 st
80	104.5	128.5	158.5	191.5	25	8	32	62	95
100	119.5	145.5	178.5	201.5	30	3.5	29.5	62.5	85.5

Made to Order

Auto Switch

With Air Cushion  
**MGP**

Basic Type  
**MGP**

# Compact Guide Cylinder With Air Cushion

# Series MGP

∅16, ∅20, ∅25, ∅32, ∅40, ∅50, ∅63, ∅80, ∅100

## How to Order

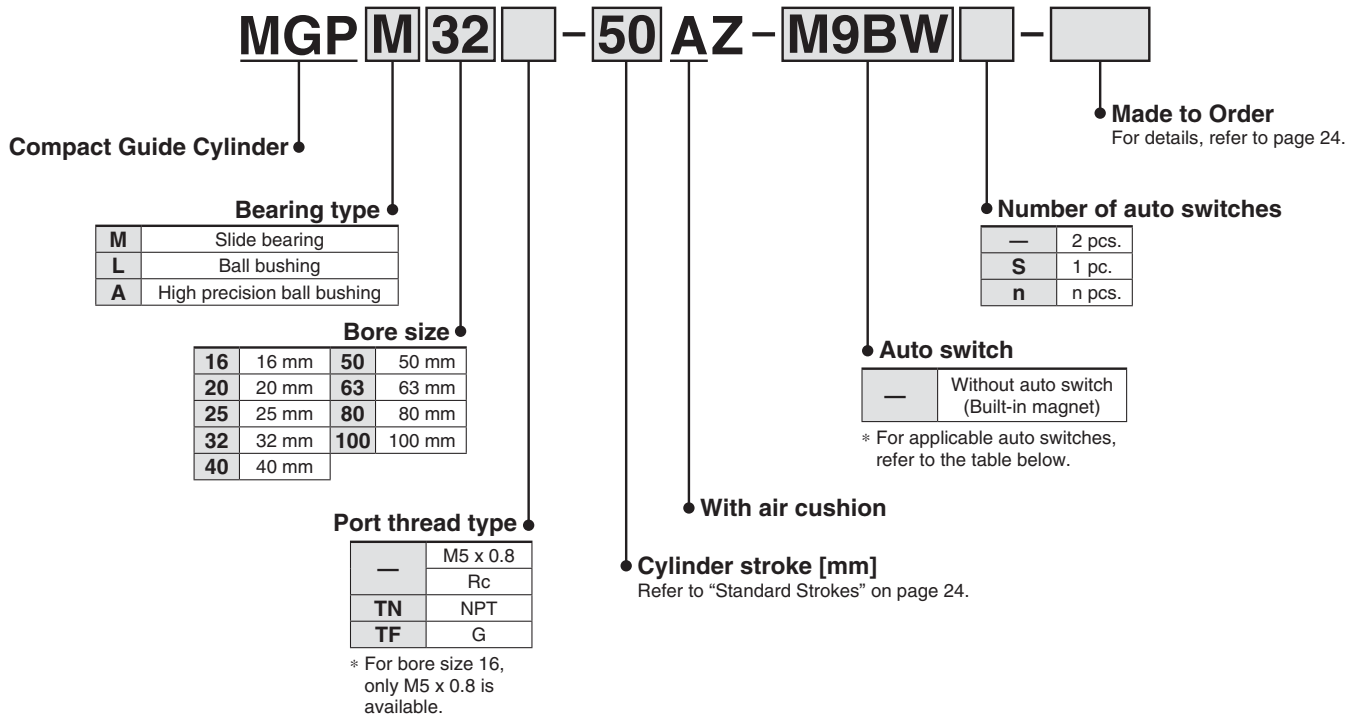

### Applicable Auto Switches/Refer to the Auto Switch Guide for further information on auto switches.

Type	Special function	Electrical entry	Indicator/light	Wiring (Output)	Load voltage		Auto switch model		Lead wire length [m]				Pre-wired connector	Applicable load			
					DC	AC	Perpendicular	In-line	0.5 (—)	1 (M)	3 (L)	5 (Z)					
Solid state auto switch	—	Grommet	Yes	3-wire (NPN)	24 V	5 V, 12 V	—	M9NV	M9N	●	●	●	○	○	IC circuit	Relay, PLC	
				3-wire (PNP)				M9PV	M9P	●	●	●	○	○			
				2-wire	M9BV	M9B	●	●	●	○	○						
	Diagnostic indication (2-colour display)			3-wire (NPN)	24 V	5 V, 12 V	—	M9NWV	M9NW	●	●	●	○	○	○		IC circuit
				3-wire (PNP)				M9PWV	M9PW	●	●	●	○	○			
				2-wire	M9BWV	M9BW	●	●	●	○	○	○	—				
				Water resistant (2-colour display)	3-wire (NPN)	24 V	5 V, 12 V	—	M9NAV***	M9NA***	○	○	●	○	○		○
	3-wire (PNP)				M9PAV***				M9PA***	○	○	●	○	○	○		
	2-wire				M9BAV***	M9BA***	○	○	●	○	○	○	—				
	Magnetic field resistant (2-colour display)			2-wire (Non-polar)	—	—	—	—	P3DWA**	●	—	●	●	○	○		—
Reed auto switch		Grommet	Yes	3-wire (NPN equivalent)	—	5 V	—	A96V	A96	●	—	●	—	—	IC circuit	—	
	2-wire			24 V	12 V	100 V or less	A93V	A93	●	—	●	●	—	—	—	Relay, PLC	
							A90V	A90	●	—	●	—	—	—	IC circuit	—	

\*\*\* Water resistant type auto switches are mountable on the above models, but in such case SMC cannot guarantee water resistance.

A water resistant type cylinder is recommended for use in an environment which requires water resistance.

However, please contact SMC for water resistant products of ∅12 and ∅16.

\* Lead wire length symbols: 0.5 m..... — (Example) M9NW  
 1 m..... M (Example) M9NWM  
 3 m..... L (Example) M9NWL  
 5 m..... Z (Example) M9NWZ

\* Solid state auto switches marked with "○" are produced upon receipt of order.

\*\* The D-P3DWA is mountable on bore size ∅25 to ∅100.

\* Since there are other applicable auto switches than listed above, refer to the Auto Switch Guide for details.

\* For details about auto switches with pre-wired connector, refer to the Auto Switch Guide.

For the D-P3DWA, refer to the D-P3DWA catalogue.

\* Auto switches are shipped together, (but not assembled).

## Specifications

Bore size [mm]	16	20	25	32	40	50	63	80	100
<b>Action</b>	Double acting								
<b>Fluid</b>	Air								
<b>Proof pressure</b>	1.5 MPa								
<b>Maximum operating pressure</b>	1.0 MPa								
<b>Minimum operating pressure</b>	0.15 MPa	0.12 MPa							
<b>Ambient and fluid temperature</b>	-10 to 60°C (No freezing)								
<b>Piston speed</b>	50 to 500 mm/s							50 to 400 mm/s	
<b>Cushion</b>	Air cushion on both ends (Without bumper)								
<b>Lubrication</b>	Not required (Non-lube)								
<b>Stroke length tolerance</b>	$^{+1.5}_0$ mm								

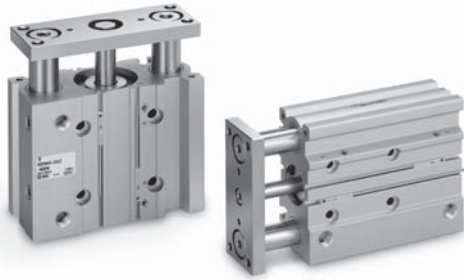

### Symbol

Air cushion

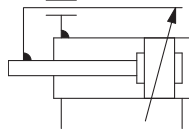

**Made to Order**  
(For details, refer to pages 44 to 55.)

Symbol	Specifications
<b>-XC19</b>	Intermediate stroke (Spacer type)
<b>-XC79</b>	Tapped hole, drilled hole, pinned hole machined additionally
<b>-XC85</b>	Grease for food processing equipment
<b>-X867</b>	Side porting type (Plug location changed)

Refer to pages 40 to 42 for cylinders with auto switches.

- Auto switch proper mounting position (detection at stroke end) and its mounting height
- Minimum stroke for auto switch mounting
- Operating range
- Auto switch mounting brackets/Part no.

## Standard Strokes

Bore size [mm]	Standard stroke [mm]
<b>16</b>	25, 50, 75, 100, 125, 150, 175, 200, 250
<b>20 to 63</b>	25, 50, 75, 100, 125, 150, 175, 200, 250, 300, 350, 400
<b>80, 100</b>	50, 75, 100, 125, 150, 175, 200, 250, 300, 350, 400

## Manufacture of Intermediate Strokes

<b>Description</b>	Intermediate strokes by the 1 mm interval are available by replacing collars of a standard stroke cylinder. Minimum manufacturable stroke $\phi 16$ to $\phi 63$ : 15 mm $\phi 80$ , $\phi 100$ : 20 mm Select a rubber bumper type, because the cushion effect is not obtainable for less than this stroke.	
<b>Model no.</b>	Add "-XC19" to the end of standard part number.	
<b>Applicable stroke [mm]</b>	$\phi 16$	15 to 249
	$\phi 20$ to $\phi 63$	15 to 399
	$\phi 80$ , $\phi 100$	20 to 399
<b>Example</b>	Part no.: MGPM20-35AZ-XC19 A collar 15 mm in width is installed in the MGPM20-50AZ. C dimension is 112 mm.	

Note) Intermediate stroke (by the 1 mm interval) based on an exclusive body will be available upon request for special.

## Theoretical Output



Bore size [mm]	Rod size [mm]	Operating direction	Piston area [mm <sup>2</sup> ]	Operating pressure [MPa]								
				0.2	0.3	0.4	0.5	0.6	0.7	0.8	0.9	1.0
<b>16</b>	8	OUT	201	40	60	80	101	121	141	161	181	201
		IN	151	30	45	60	75	90	106	121	136	151
<b>20</b>	10	OUT	314	63	94	126	157	188	220	251	283	314
		IN	236	47	71	94	118	141	165	188	212	236
<b>25</b>	10	OUT	491	98	147	196	245	295	344	393	442	491
		IN	412	82	124	165	206	247	289	330	371	412
<b>32</b>	14	OUT	804	161	241	322	402	483	563	643	724	804
		IN	650	130	195	260	325	390	455	520	585	650
<b>40</b>	14	OUT	1257	251	377	503	628	754	880	1005	1131	1257
		IN	1103	221	331	441	551	662	772	882	992	1103
<b>50</b>	20	OUT	1963	393	589	785	982	1178	1374	1571	1767	1963
		IN	1649	330	495	660	825	990	1154	1319	1484	1649
<b>63</b>	20	OUT	3117	623	935	1247	1559	1870	2182	2494	2806	3117
		IN	2803	561	841	1121	1402	1682	1962	2242	2523	2803
<b>80</b>	25	OUT	5027	1005	1508	2011	2513	3016	3519	4021	4524	5027
		IN	4536	907	1361	1814	2268	2722	3175	3629	4082	4536
<b>100</b>	30	OUT	7854	1571	2356	3142	3927	4712	5498	6283	7069	7854
		IN	7147	1429	2144	2859	3574	4288	5003	5718	6432	7147

Note) Theoretical output [N] = Pressure [MPa] x Piston area [mm<sup>2</sup>]

# Series MGP

## Weights

### Slide Bearing: MGPM16 to 100 [kg]

Bore size [mm]	Standard stroke [mm]											
	25	50	75	100	125	150	175	200	250	300	350	400
16	0.46	0.62	0.74	0.83	1.02	1.10	1.19	1.28	1.46	—	—	—
20	0.77	1.02	1.21	1.35	1.49	1.63	1.77	1.91	2.55	2.83	3.11	3.39
25	1.06	1.43	1.68	1.84	2.01	2.18	2.35	2.52	3.50	3.84	4.18	4.51
32	1.66	2.06	2.42	2.65	2.88	3.11	3.34	3.57	5.07	5.53	5.99	6.46
40	1.95	2.40	2.79	3.06	3.33	3.59	3.86	4.13	5.71	6.25	6.78	7.32
50	3.26	3.96	4.55	4.96	5.36	5.76	6.16	6.56	9.03	9.83	10.63	11.43
63	4.11	4.90	5.58	6.07	6.56	7.05	7.54	8.04	10.68	11.66	12.64	13.63
80	—	7.47	8.35	8.95	9.55	10.15	10.75	11.35	15.04	16.24	17.44	18.65
100	—	12.10	13.37	14.24	15.11	15.98	16.85	17.72	22.88	24.62	26.36	28.10

### Ball Bushing: MGPL16 to 100, High Precision Ball Bushing: MGPA16 to 100 [kg]

Bore size [mm]	Standard stroke [mm]											
	25	50	75	100	125	150	175	200	250	300	350	400
16	0.48	0.58	0.66	0.83	0.94	1.02	1.11	1.19	1.36	—	—	—
20	0.82	0.97	1.10	1.35	1.50	1.63	1.76	1.89	2.33	2.59	2.84	3.10
25	1.16	1.34	1.49	1.83	2.03	2.18	2.34	2.49	3.11	3.41	3.72	4.02
32	1.58	2.00	2.29	2.67	2.95	3.15	3.36	3.57	4.47	4.88	5.29	5.70
40	1.87	2.33	2.65	3.06	3.38	3.63	3.87	4.11	5.09	5.57	6.06	6.54
50	3.10	3.81	4.30	4.92	5.42	5.79	6.17	6.55	8.08	8.83	9.58	10.33
63	3.94	4.74	5.34	6.05	6.64	7.11	7.58	8.05	9.77	10.71	11.65	12.59
80	—	7.61	8.35	8.91	9.46	10.02	10.57	11.13	13.99	15.10	16.21	17.32
100	—	12.04	13.14	13.97	14.79	15.62	16.44	17.27	21.14	22.80	24.45	26.10

## Allowable Rotational Torque of Plate

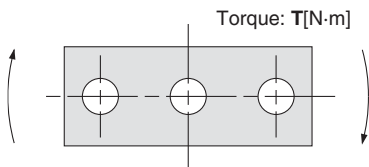

Bore size [mm]	Bearing type	Stroke											
		25	50	75	100	125	150	175	200	250	300	350	400
16	MGPM	0.53	0.84	0.69	0.58	0.50	0.44	0.40	0.36	0.30	—	—	—
	MGPL/A	1.27	0.86	0.65	0.52	0.43	0.37	0.32	0.28	0.23	—	—	—
20	MGPM	0.99	2.23	1.88	1.63	1.44	1.28	1.16	1.06	0.90	0.78	0.69	0.62
	MGPL/A	2.66	1.94	1.52	1.57	1.34	1.17	1.03	0.93	0.76	0.65	0.56	0.49
25	MGPM	1.64	3.51	2.96	2.57	2.26	2.02	1.83	1.67	1.42	1.24	1.09	0.98
	MGPL/A	4.08	3.02	2.38	2.41	2.05	1.78	1.58	1.41	1.16	0.98	0.85	0.74
32	MGPM	6.35	6.64	5.69	4.97	4.42	3.98	3.61	3.31	2.84	2.48	2.20	1.98
	MGPL/A	5.95	5.89	5.11	6.99	6.34	5.79	5.33	4.93	4.29	3.78	3.38	3.04
40	MGPM	7.00	7.32	6.27	5.48	4.87	4.38	3.98	3.65	3.13	2.74	2.43	2.19
	MGPL/A	6.55	6.49	5.62	7.70	6.98	6.38	5.87	5.43	4.72	4.16	3.71	3.35
50	MGPM	13.0	13.8	12.0	10.6	9.50	8.60	7.86	7.24	6.24	5.49	4.90	4.43
	MGPL/A	9.17	11.2	9.80	12.8	11.6	10.7	9.80	9.10	7.95	7.02	6.26	5.63
63	MGPM	14.7	15.6	13.5	11.9	10.7	9.69	8.86	8.16	7.04	6.19	5.52	4.99
	MGPL/A	10.2	12.5	11.0	14.3	13.0	11.9	11.0	10.2	8.84	7.80	6.64	6.24
80	MGPM	—	26.0	22.9	20.5	18.6	17.0	15.6	14.5	12.6	11.2	10.0	9.11
	MGPL/A	—	25.2	22.7	20.6	18.9	17.3	16.0	14.8	12.9	11.3	10.0	8.94
100	MGPM	—	41.9	37.5	33.8	30.9	28.4	26.2	24.4	21.4	19.1	17.2	15.7
	MGPL/A	—	41.7	37.9	34.6	31.8	29.3	27.2	25.3	22.1	19.5	17.3	15.5

## High Precision Ball Bushing/MGPA

### ⚠ Caution

#### Positioning accuracy for pin hole on the plate

Dispersion of dimensions when machining each component will be accumulated in the plate pin hole positioning accuracy when mounting this cylinder. Values below are referred as a guide.

[Side mounting]

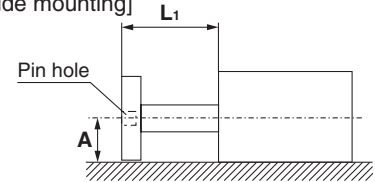

$$A = \text{Catalogue dimension} \pm (0.1 + L_1 \times 0.0008) \text{ [mm]}$$

\*: To be 0.15 for  $\phi 80$ ,  $\phi 100$

Note) Displacement by load and self-weight deflection by plate and guide rod are not included.

[Bottom mounting]

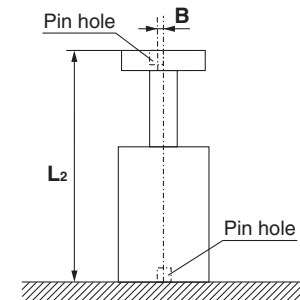

$$B = \pm (0.045 + L_2 \times 0.0016) \text{ [mm]}$$

## Non-rotating Accuracy of Plate

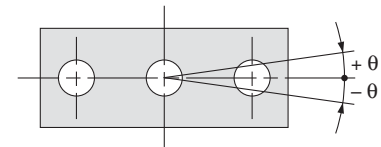

Non-rotating accuracy  $\theta$  when retracted and when no load is applied should be not more than the values shown in the table.

Bore size [mm]	Non-rotating accuracy $\theta$		
	MGPM	MGPL	MGPA
16	$\pm 0.07^\circ$	$\pm 0.05^\circ$	$\pm 0.01^\circ$
20	$\pm 0.06^\circ$	$\pm 0.04^\circ$	
25	$\pm 0.05^\circ$	$\pm 0.03^\circ$	
32	$\pm 0.04^\circ$	$\pm 0.03^\circ$	
40	$\pm 0.04^\circ$	$\pm 0.03^\circ$	
50	$\pm 0.03^\circ$	$\pm 0.03^\circ$	
63	$\pm 0.03^\circ$	$\pm 0.03^\circ$	
80	$\pm 0.03^\circ$	$\pm 0.03^\circ$	
100	$\pm 0.03^\circ$	$\pm 0.03^\circ$	

**High Precision Ball Bushing/MGPA Plate Displacement Amount (Reference Values)**

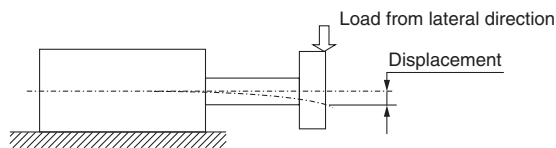

**MGPA16**

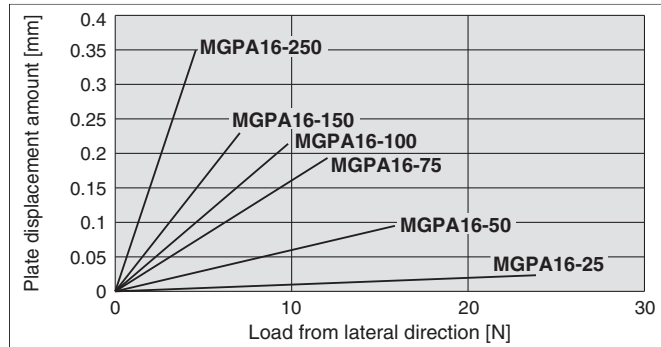

**MGPA50, 63**

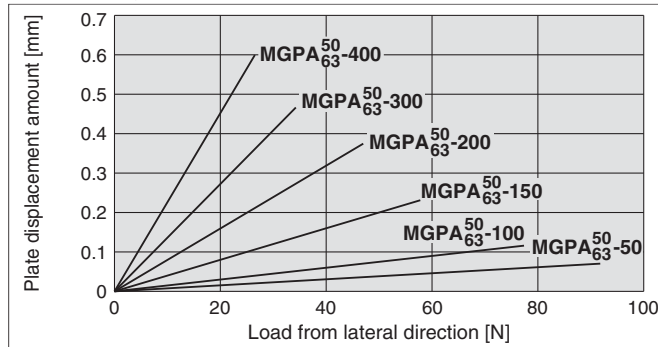

**MGPA20**

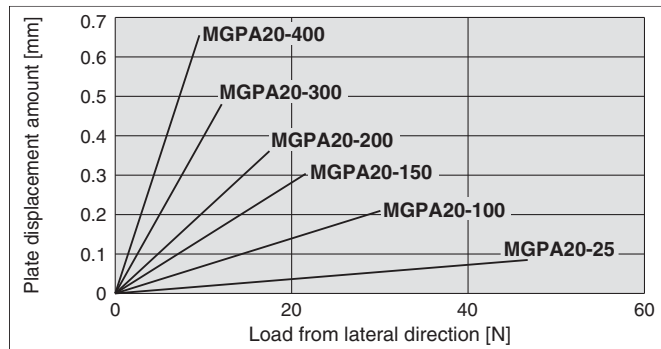

**MGPA80**

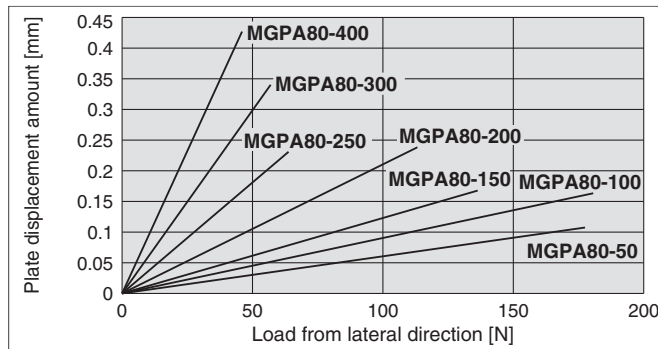

**MGPA25**

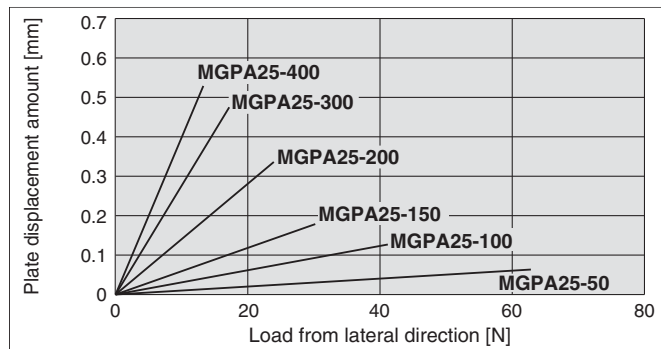

**MGPA100**

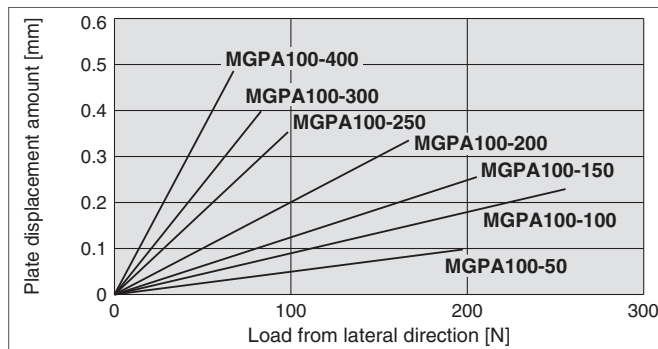

**MGPA32, 40**

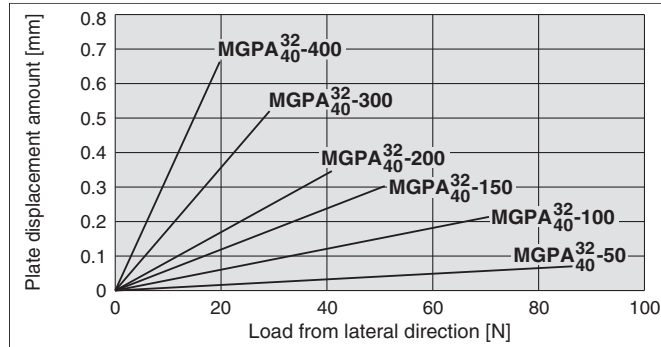

Note 1) The guide rod and self-weight for the plate are not included in the above displacement values.

Note 2) Allowable rotating torque, and operating range when used as a lifter, are the same as those of the MGPL series.

Basic Type **MGP**

With Air Cushion **MGP**

Auto Switch

Made to Order

# With Air Cushion Series MGP Model Selection

## Selection Conditions

Mounting orientation	Vertical		Horizontal	
Maximum speed [mm/s]	200 or less	400	200 or less	400
Graph (Slide bearing)	(1), (2)	(3), (4)	(15), (16)	(17), (18)
Graph (Ball bushing)	(5) to (9)	(10) to (14)	(19), (20)	(21), (22)

### Selection Example 1 (Vertical Mounting)

#### Selection conditions

Mounting: Vertical  
Bearing type: Ball bushing  
Stroke: 75 stroke  
Maximum speed: 200 mm/s  
Load weight: 7 kg  
Eccentric distance: 70 mm

Find the point of intersection for the load weight of 7 kg and the eccentric distance of 70 mm on graph (5), based on vertical mounting, ball bushing, 75 mm stroke, and the speed of 200 mm/s.

→ **MGPL25-75AZ** is selected.

(5) 75 stroke or less,  $V = 200$  mm/s or less

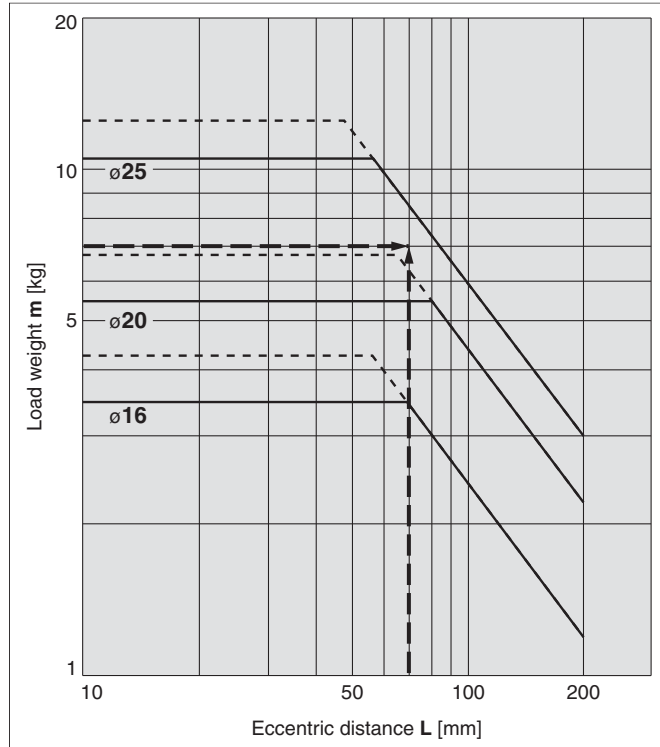

### Selection Example 2 (Horizontal Mounting)

#### Selection conditions

Mounting: Horizontal  
Bearing type: Slide bearing  
Distance between plate and load centre of gravity: 40 mm  
Maximum speed: 400 mm/s  
Load weight: 8 kg  
Stroke: 100 stroke

Find the point of intersection for the load weight of 8 kg and 100 stroke on graph (17), based on horizontal mounting, slide bearing, the distance of 40 mm between the plate and load centre of gravity, and the speed of 400 mm/s.

→ **MGPM32-100AZ** is selected.

(17)  $L = 50$  mm,  $V = 400$  mm/s

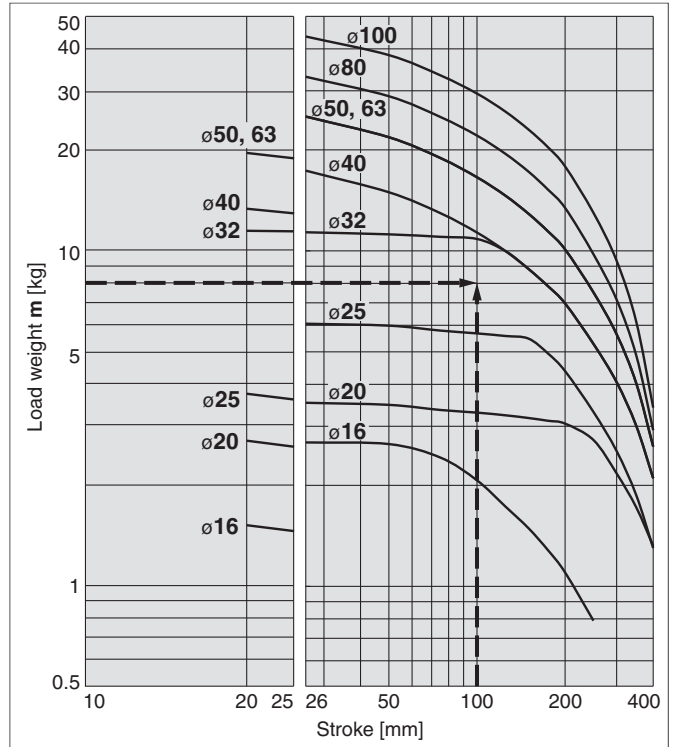

· When the maximum speed exceeds 200 mm/s, the allowable load weight is determined by multiplying the value shown in the graph at 400 mm/s by the coefficient listed in the table below.

Maximum	Up to 300 mm/s	Up to 400 mm/s	Up to 500 mm/s
Coefficient	1.7	1	0.6

· Use the "Guide Cylinder Selection Software", when the eccentric distance is 200 mm or more.



**Vertical Mounting Slide Bearing**

— Operating pressure 0.4 MPa  
 - - - - Operating pressure 0.5 MPa or more

**MGPM16 to 100**

(1) 25 stroke, V = 200 mm/s or less

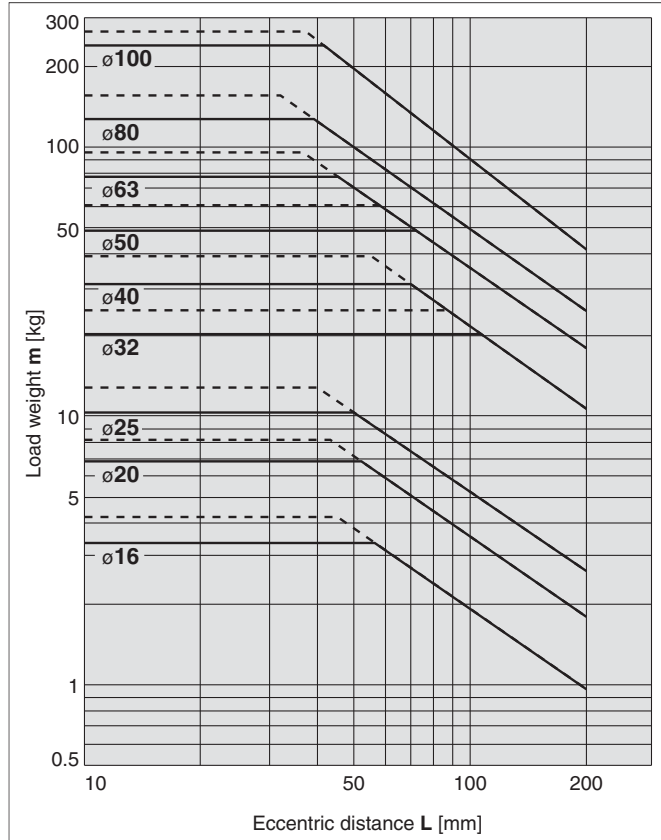

(2) Over 25 stroke, V = 200 mm/s or less

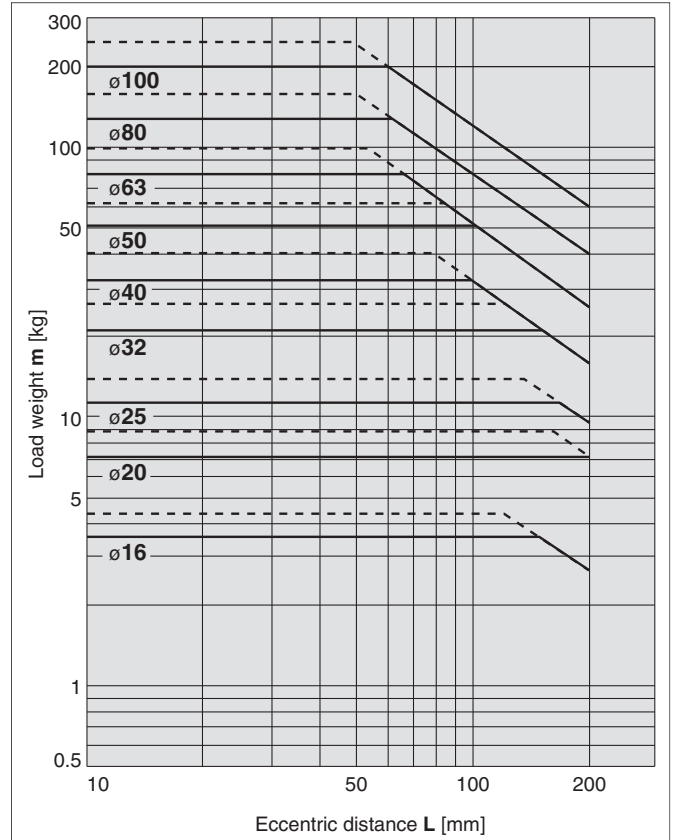

(3) 25 stroke, V = 400 mm/s

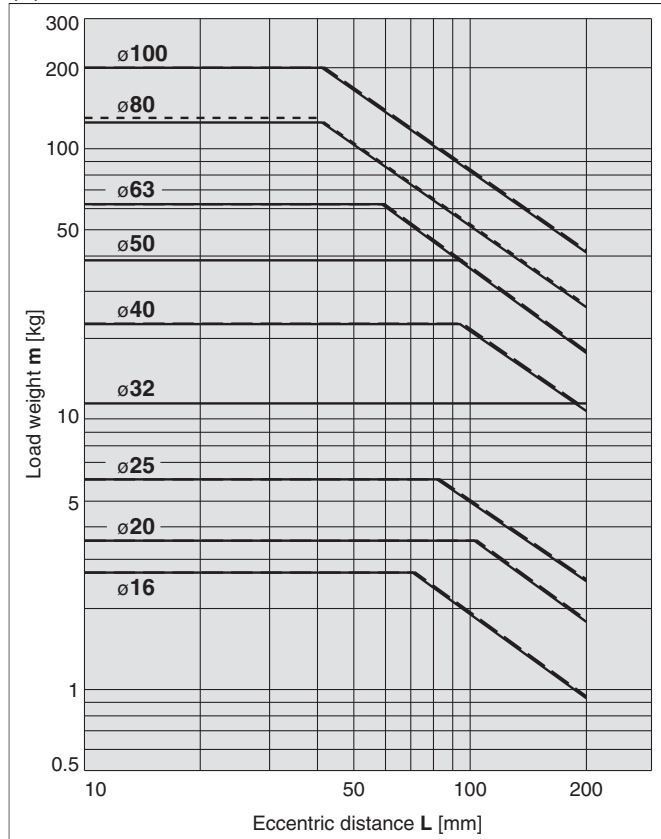

(4) Over 25 stroke, V = 400 mm/s

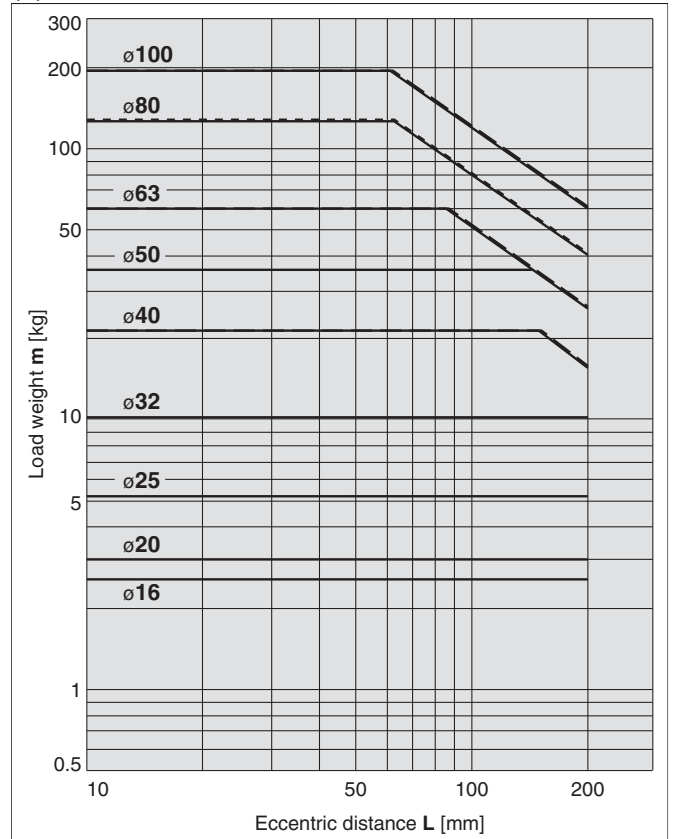

· Use the "Guide Cylinder Selection Software", when the eccentric distance is 200 mm or more.

Basic Type **MGP**

With Air Cushion **MGP**

Auto Switch

Made to Order

# Series MGP

## Vertical Mounting **Ball Bushing**

— Operating pressure 0.4 MPa  
 - - - - Operating pressure 0.5 MPa or more

### MGPL16 to 25

(5) 75 stroke or less,  $V = 200$  mm/s or less

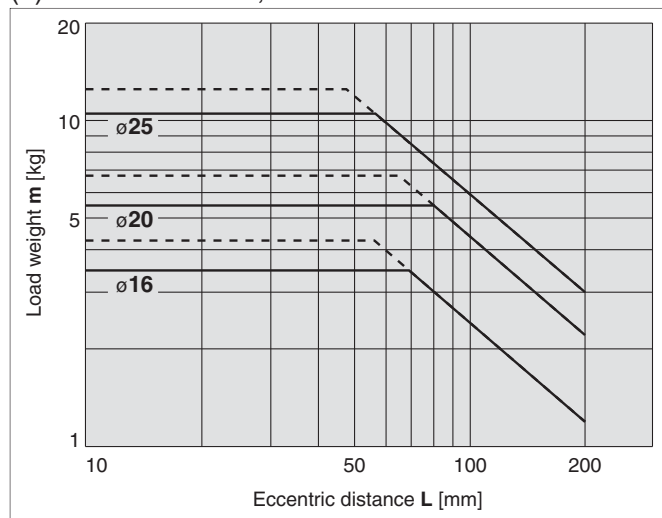

(6) Over 75 stroke,  $V = 200$  mm/s or less

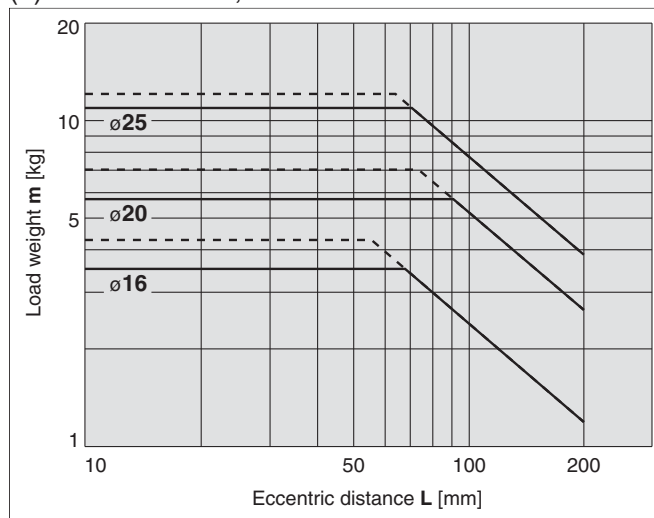

### MGPL32 to 63

(7) 25 stroke,  $V = 200$  mm/s or less

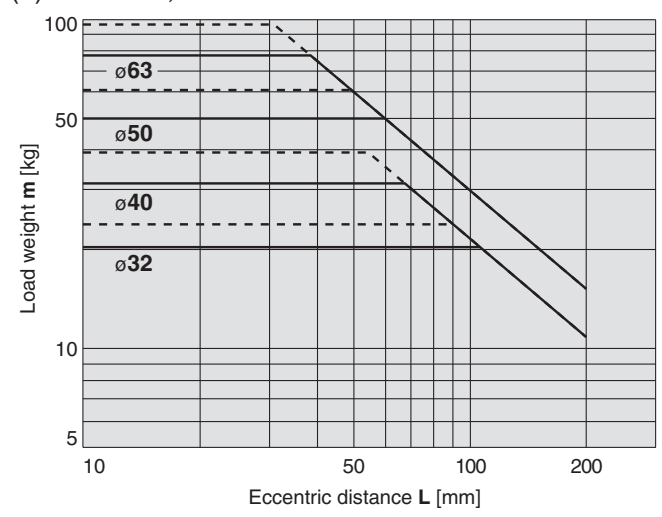

(8) Over 25 stroke,  $V = 200$  mm/s or less

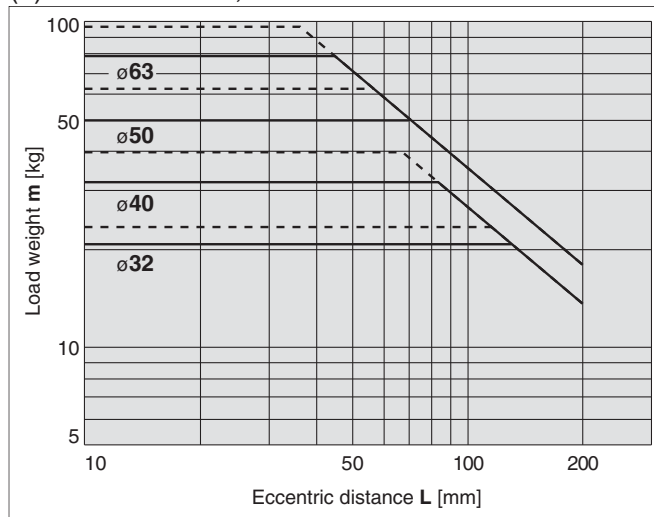

### MGPL80/100

(9)  $V = 200$  mm/s or less

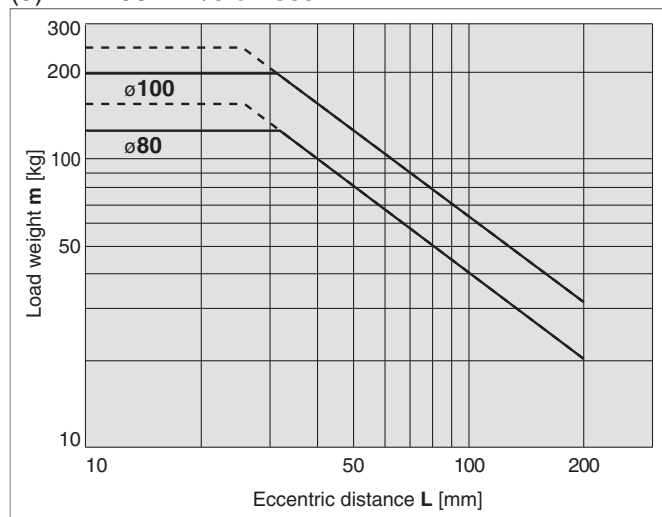

· Use the "Guide Cylinder Selection Software", when the eccentric distance is 200 mm or more.

**Vertical Mounting** **Ball Bushing**

— Operating pressure 0.4 MPa

**MGPL16 to 25**

(10) 75 stroke or less, V = 400 mm/s

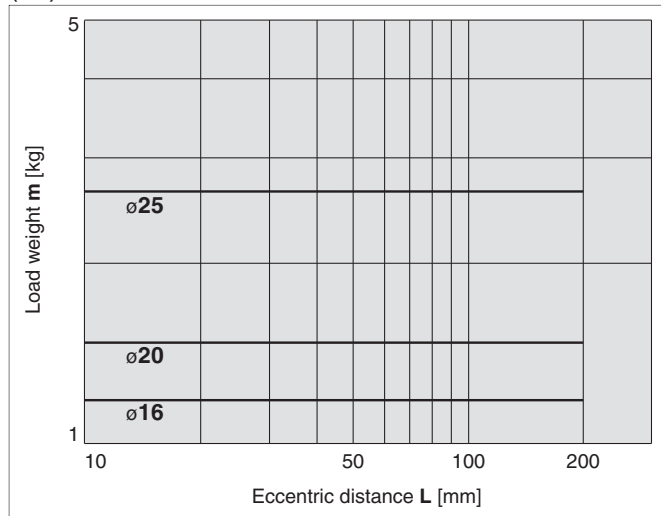

(11) Over 75 stroke, V = 400 mm/s

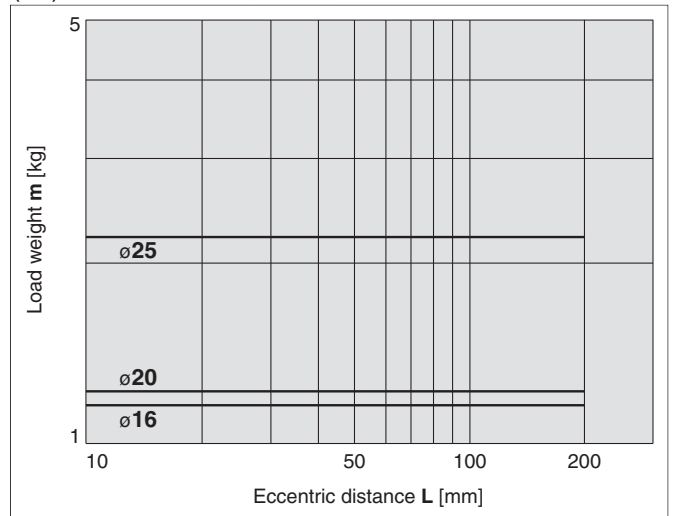

**MGPL32 to 63**

(12) 25 stroke, V = 400 mm/s

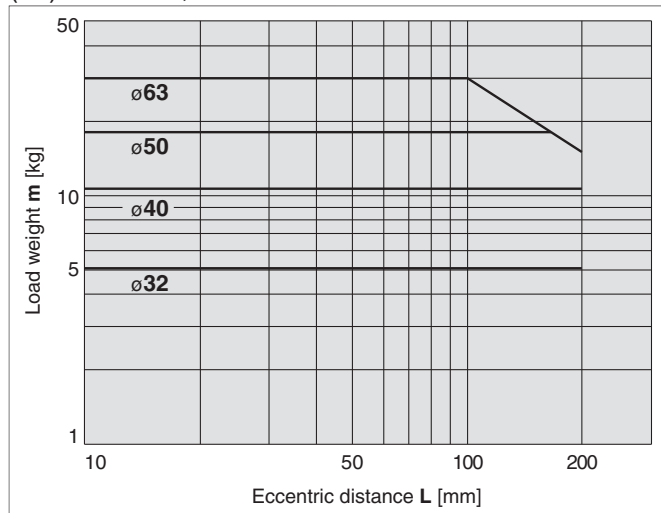

(13) Over 25 stroke, V = 400 mm/s

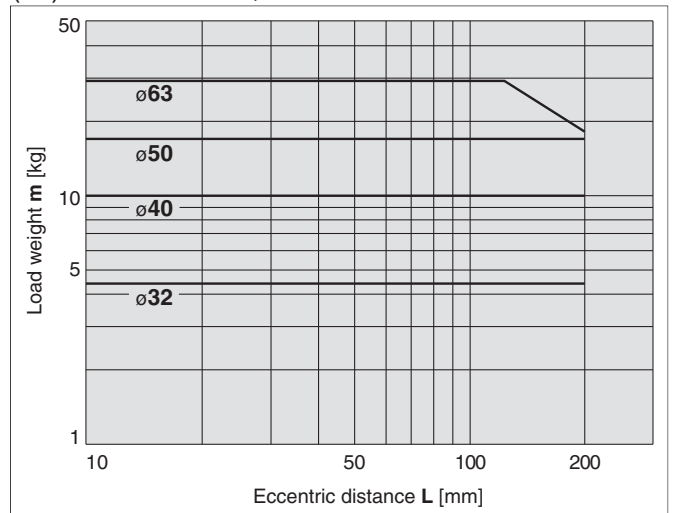

**MGPL80/100**

(14) V = 400 mm/s

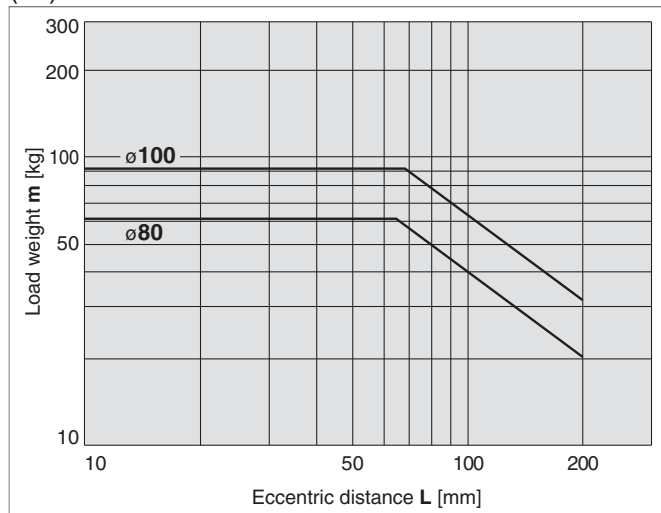

· Use the "Guide Cylinder Selection Software", when the eccentric distance is 200 mm or more.

Basic Type **MGP**

With Air Cushion **MGP**

Auto Switch

Made to Order

## Horizontal Mounting Slide Bearing

### MGPM16 to 100

(15) L = 50 mm, V = 200 mm/s or less

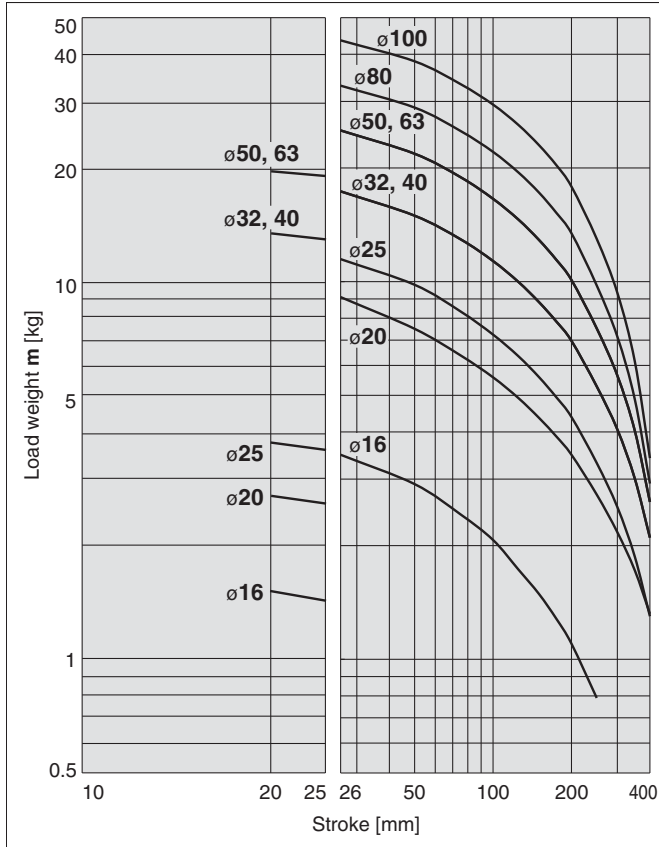

(16) L = 100 mm, V = 200 mm/s or less

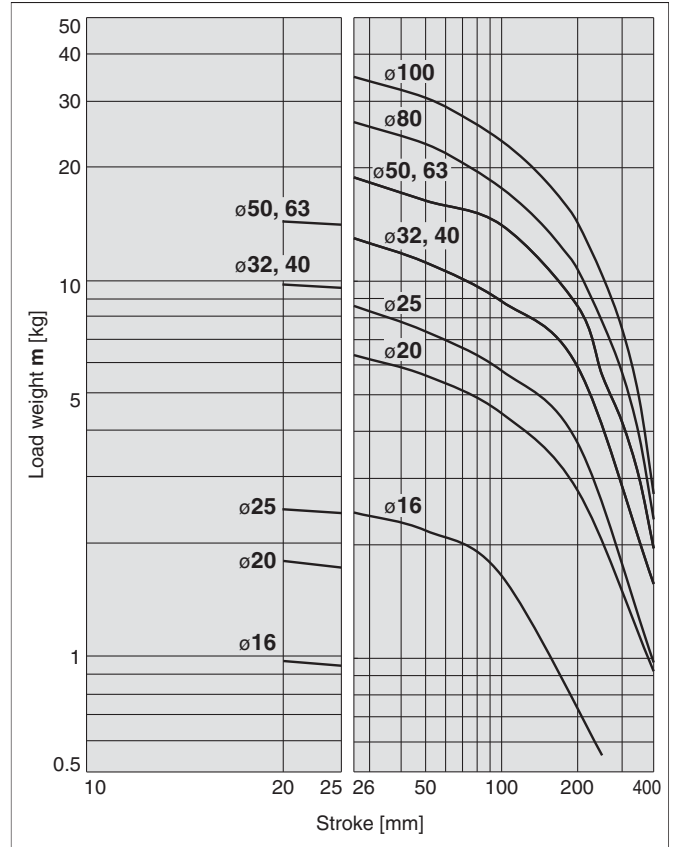

(17) L = 50 mm, V = 400 mm/s

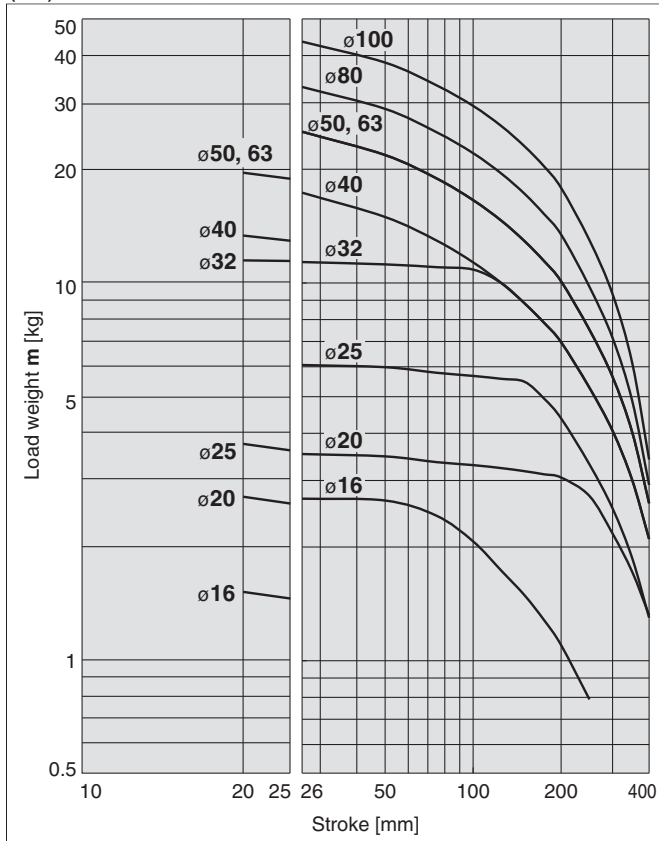

(18) L = 100 mm, V = 400 mm/s

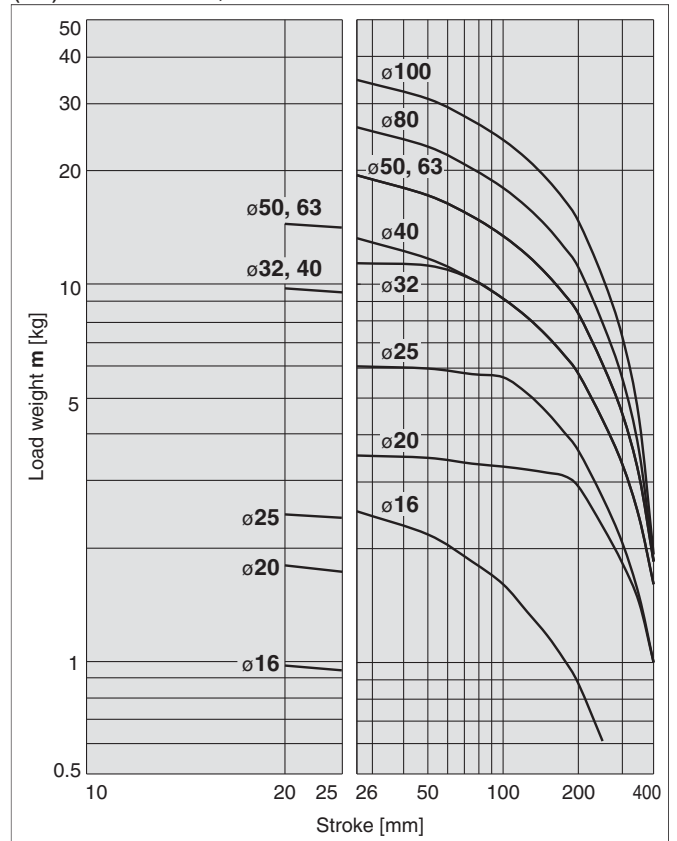

**Horizontal Mounting** **Ball Bushing**

(19) L = 50 mm, V = 200 mm/s or less

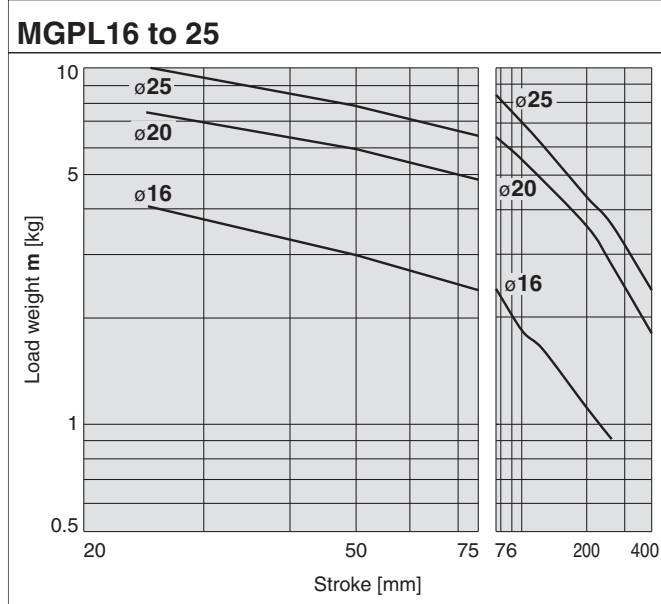

(20) L = 100 mm, V = 200 mm/s or less

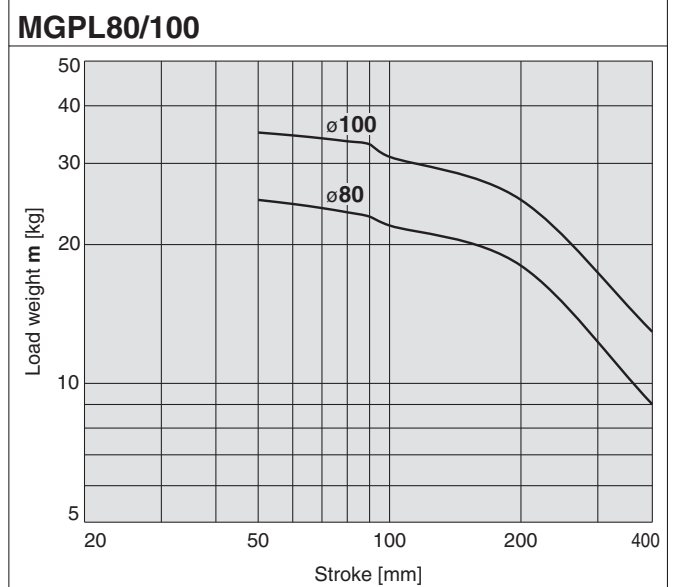
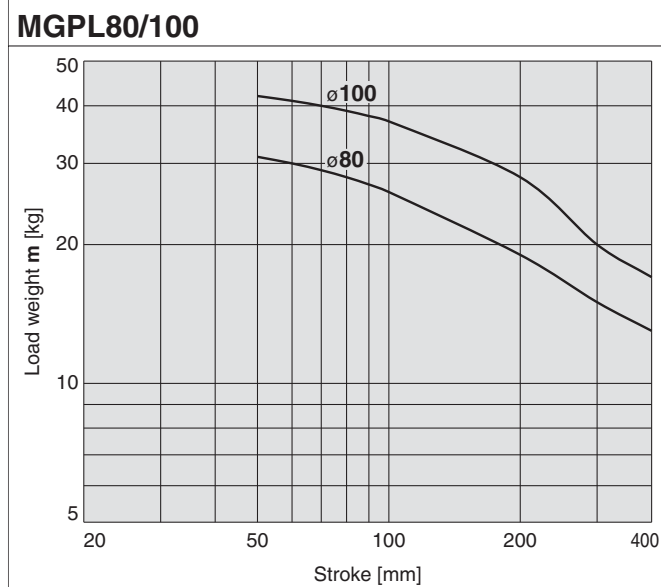
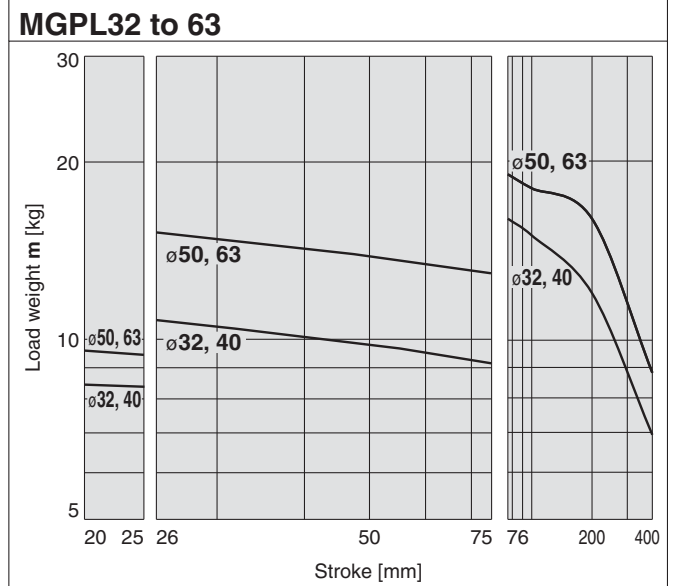
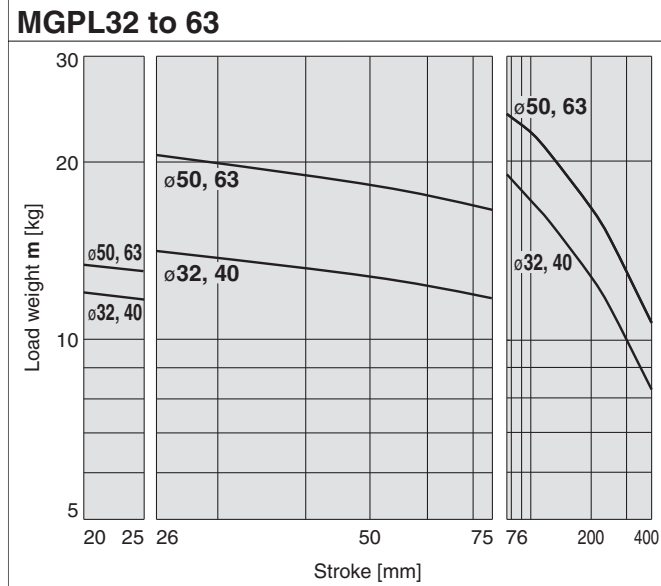
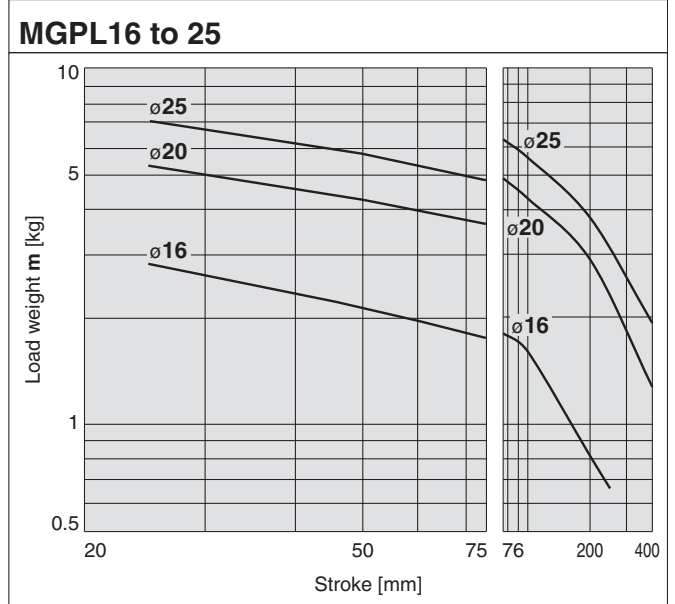

Basic Type **MGP**

With Air Cushion **MGP**

Auto Switch

Made to Order

# Series MGP

## Horizontal Mounting **Ball Bushing**

(21) L = 50 mm, V = 400 mm/s

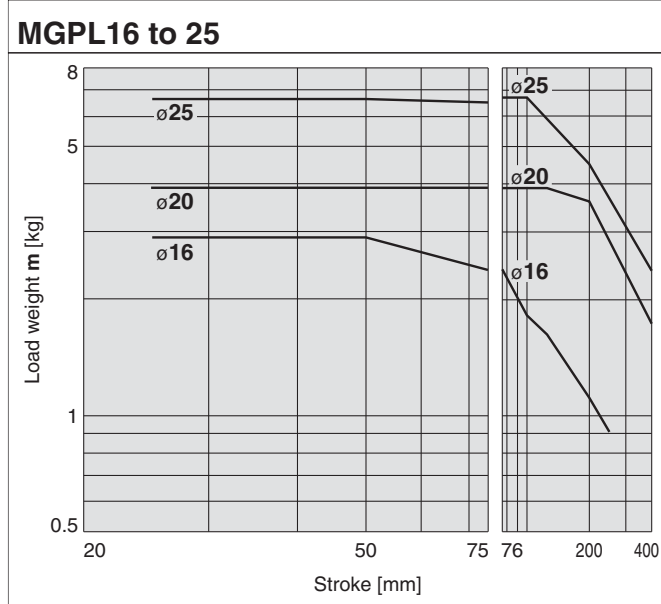

(22) L = 100 mm, V = 400 mm/s

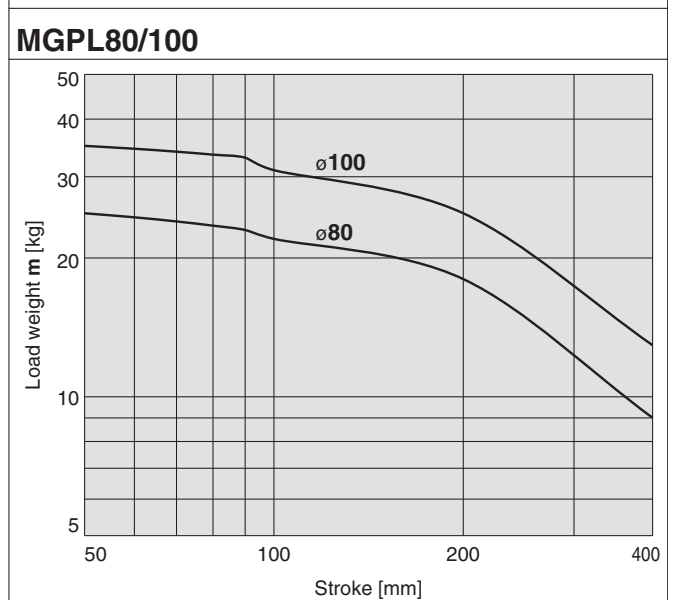
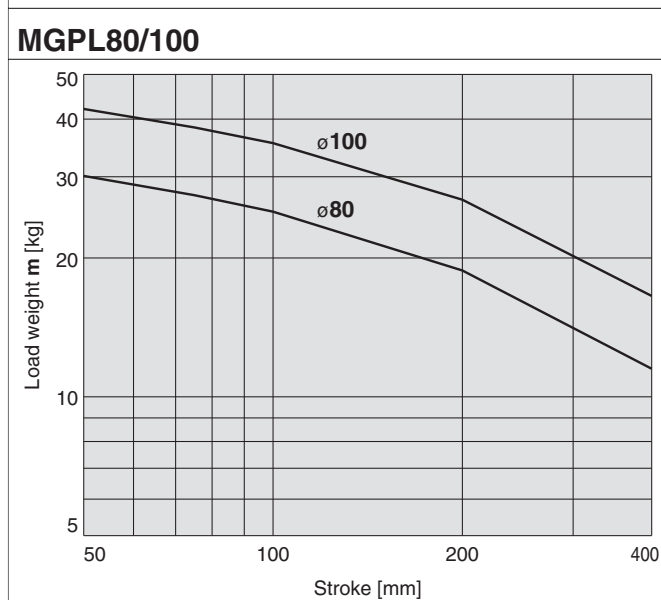
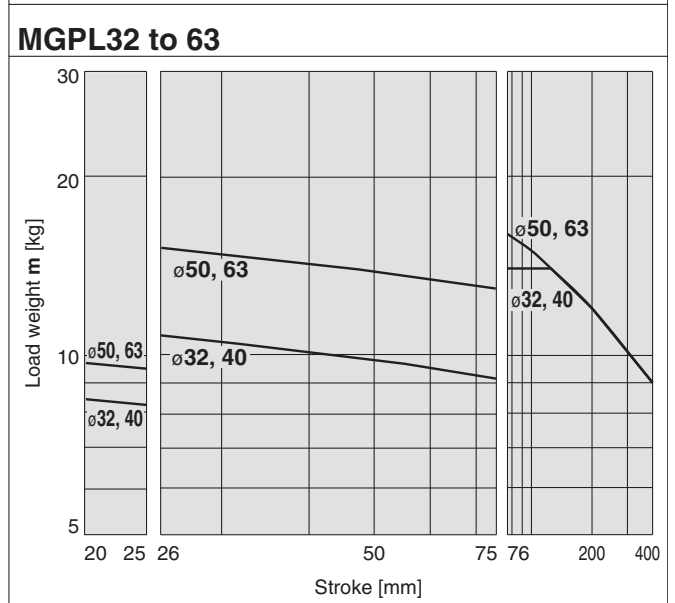
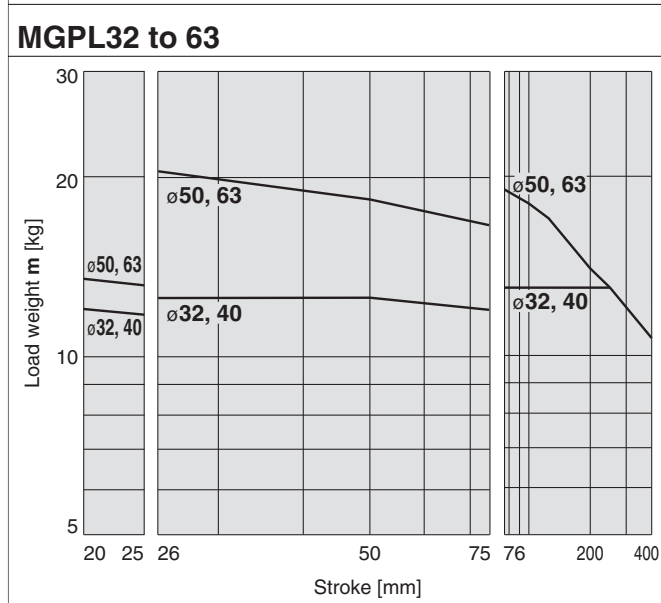
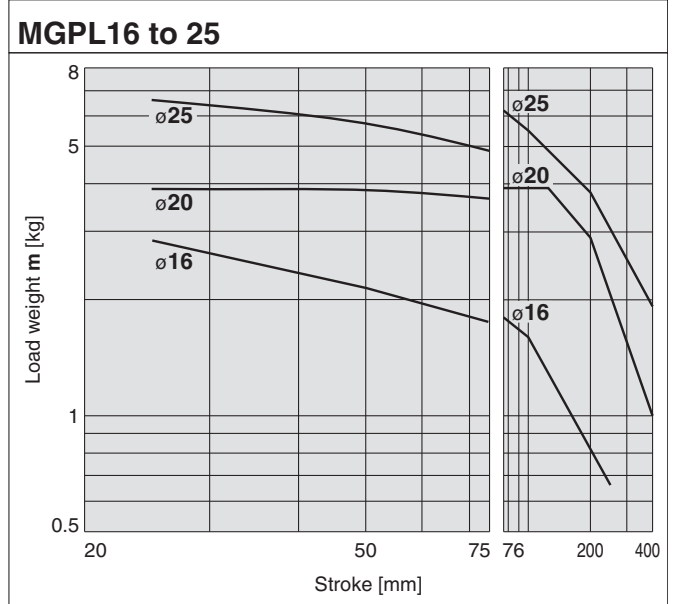

**Operating Range when Used as Stopper**

**Bore Size  $\phi 16$  to  $\phi 25$ /MGPM16 to 25 (Slide Bearing)**

**MGPM16 to 25 (Slide Bearing)**

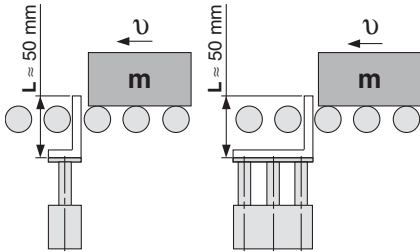

\* When selecting a model with a longer L dimension, be sure to choose a bore size which is sufficiently large.

**⚠ Caution**

**Caution on handling**

- Note 1) When using as a stopper, select a model with 25 stroke or less.
- Note 2) The MGPL (Ball bushing) and the MGPA (High precision ball bushing) cannot be used as a stopper.

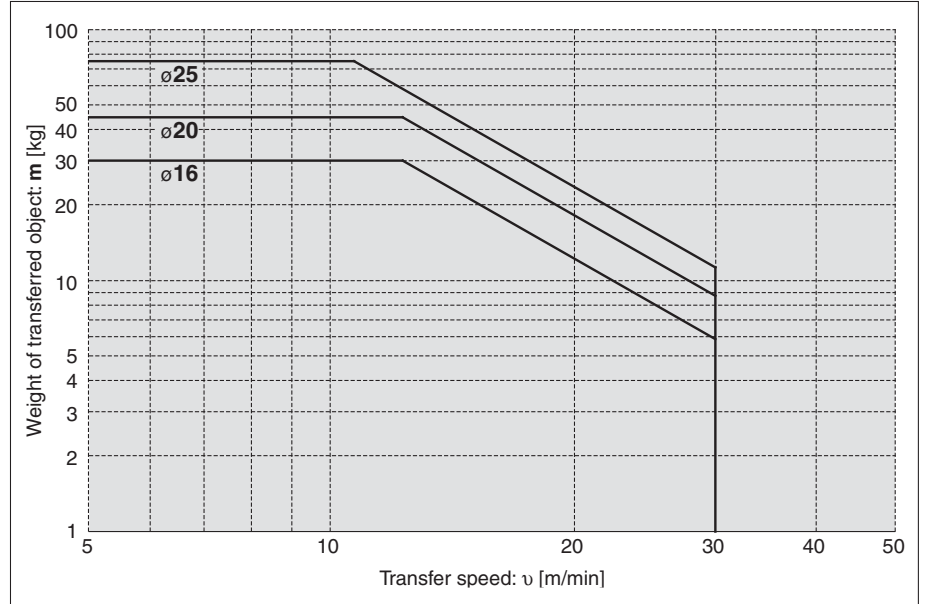

**Bore Size  $\phi 32$  to  $\phi 100$ /MGPM32 to 100 (Slide Bearing)**

**MGPM32 to 100 (Slide Bearing)**

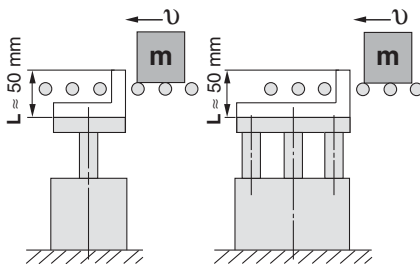

\* When selecting a model with a longer L dimension, be sure to choose a bore size which is sufficiently large.

**⚠ Caution**

**Caution on handling**

- Note 1) When using as a stopper, select a model with 50 stroke or less.
- Note 2) The MGPL (Ball bushing) and the MGPA (High precision ball bushing) cannot be used as a stopper.

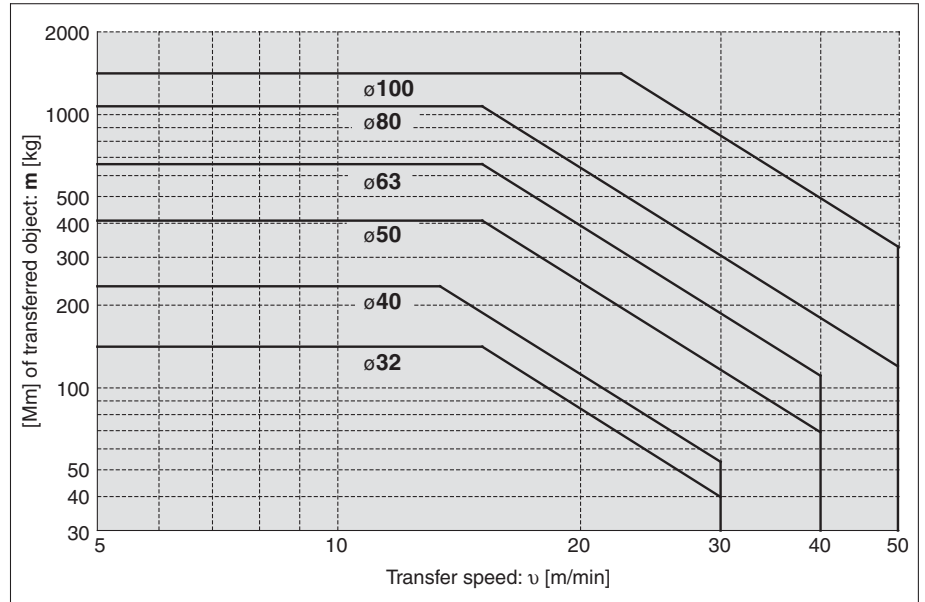

\* Refer to graphs (15) and (17) if line pressure is applied by a roller conveyor after the workpiece is stopped.

Basic Type **MGP**

With Air Cushion **MGP**

Auto Switch

Made to Order

# Series MGP

## Construction (With Air Cushion)/Series MGPM

### MGPM

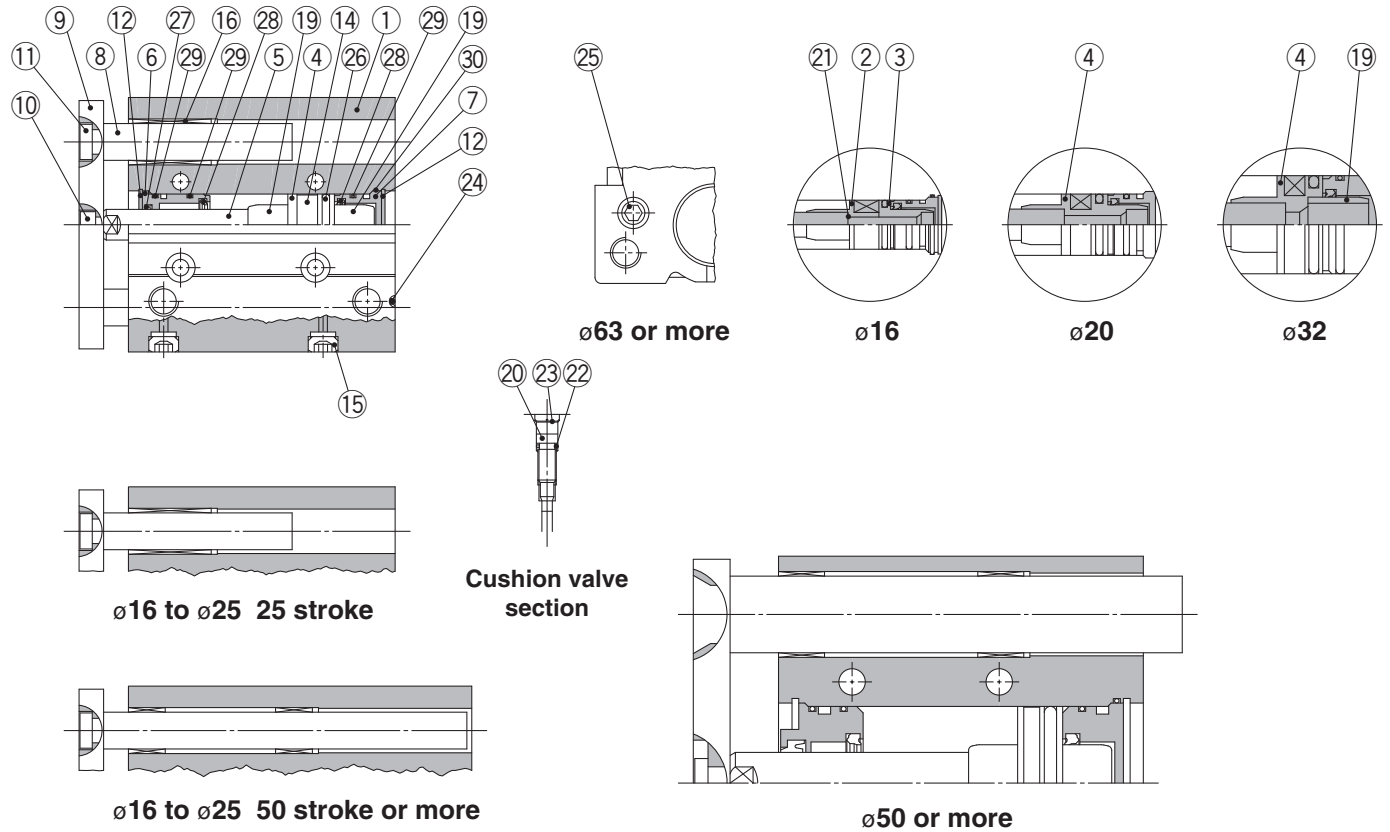

### Component Parts

No.	Description	Material	Note
1	Body	Aluminium alloy	Hard Anodised
2	Piston A	Aluminium alloy	ø16 Chromated
3	Piston B	Aluminium alloy	ø16 Chromated
4	Piston	Aluminium alloy	ø20 to ø100 Chromated
5	Piston rod	Stainless steel	ø16 to ø25
		Carbon steel	ø32 to ø100 Hard chrome plating
6	Collar	Aluminium alloy	Chromated
7	Head cover	Aluminium alloy	Chromated
8	Guide rod	Carbon steel	Hard chrome plating
9	Plate	Carbon steel	Nickel plating
10	Plate mounting bolt	Carbon steel	Nickel plating
11	Guide bolt	Carbon steel	Nickel plating
12	Retaining ring	Carbon tool steel	Phosphate coated
13	Retaining ring	Carbon tool steel	Phosphate coated
14	Magnet	—	
15	Plug Hexagon socket head plug	Carbon steel	ø16 Nickel plating
			ø20 to ø100
16	Slide bearing	Bearing alloy	
17	Ball bushing	—	
18	Spacer	Aluminium alloy	
19	Cushion ring	Aluminium alloy	ø25 to ø100 Anodised
			ø16 to ø32 Electroless nickel plating
20	Cushion valve		ø50 to ø100 Chromated
			ø40 only Electroless nickel plating

### Component Parts

No.	Description	Material	Note
21	Gasket	NBR	ø16
22	Gasket	NBR	
23	Retaining ring	Carbon tool steel	ø50, ø63 Phosphate coated
24	Steel ball	Carbon steel	ø16 to ø50
25	Plug	Carbon steel	ø63 to ø100 Nickel plating
26*	Piston seal	NBR	
27*	Rod seal	NBR	
28*	Cushion seal	Urethane	
29*	Gasket A	NBR	
30*	Gasket B	NBR	

### Replacement Parts/Seal Kit

Bore size [mm]	Kit no.	Contents	Bore size [mm]	Kit no.	Contents
16	MGP16-AZ-PS	Set of nos. above 26, 27, 28, 29, 30	50	MGP50-AZ-PS	Set of nos. above 26, 27, 28, 29, 30
20	MGP20-AZ-PS		63	MGP63-AZ-PS	
25	MGP25-AZ-PS		80	MGP80-AZ-PS	
32	MGP32-AZ-PS		100	MGP100-AZ-PS	
40	MGP40-AZ-PS				

\* Seal kit includes 26 to 30. Order the seal kit, based on each bore size.  
 \* Since the seal kit does not include a grease pack, order it separately.  
**Grease pack part no.: GR-S-010 (10 g)**



**Construction (With Air Cushion)/Series MGPL**

**MGPL**

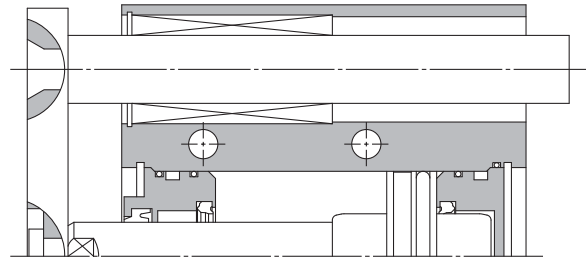
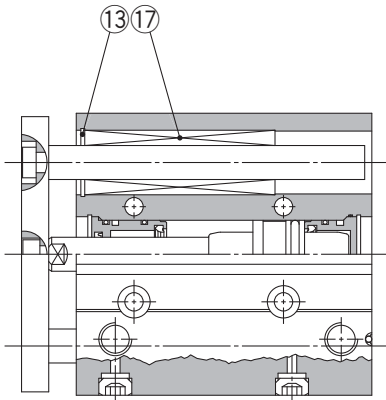

**ø50 or more**

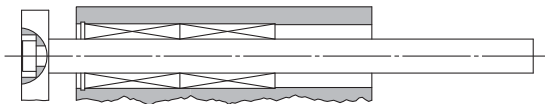

**ø16 75 stroke or less**

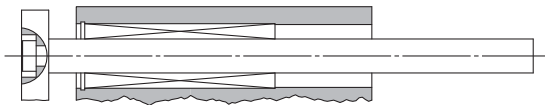

**ø20 to ø63 75 stroke or less**

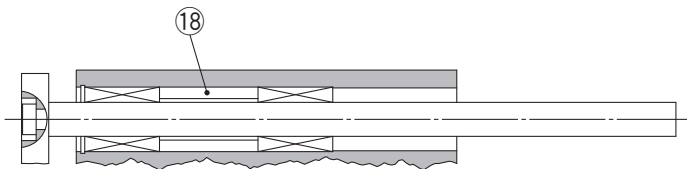

**ø16 to ø63 100 stroke or more  
ø80, ø100 250 stroke or more**

Basic Type

**MGP**

With Air Cushion

**MGP**

Auto Switch

Made to Order

# Series MGP

## Ø16 to Ø25/MGPM, MGPL, MGPA (With Air Cushion)

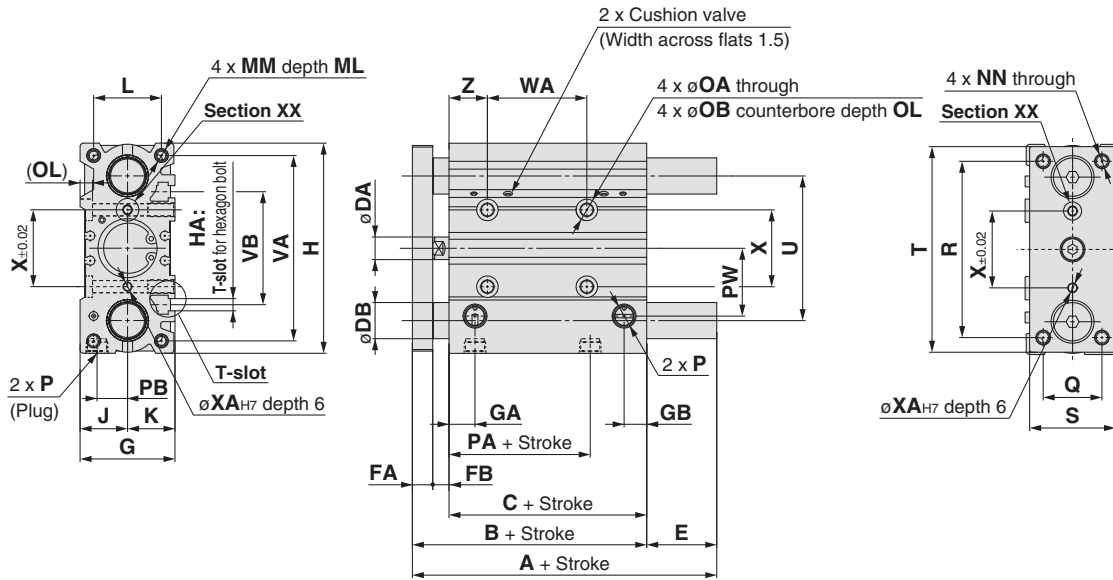
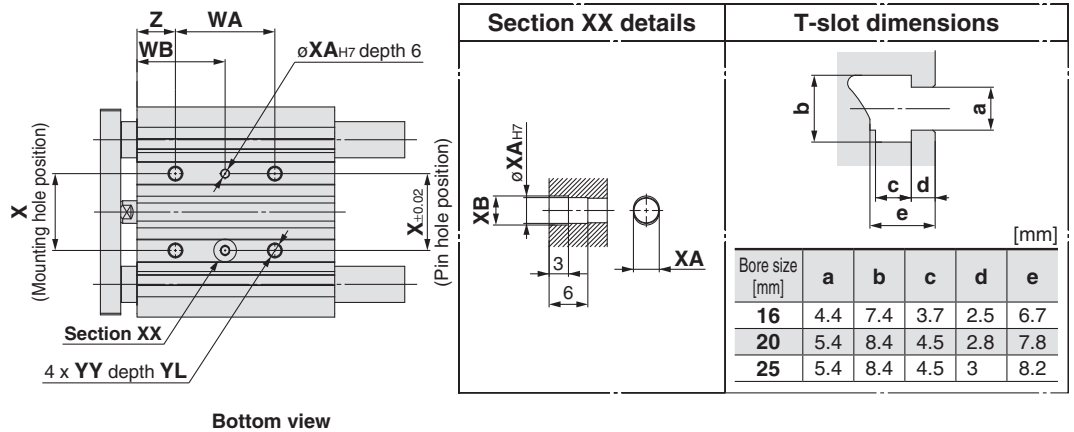

- \* The use of a slot (width XA, length XB, depth 3) allows for a relaxed pin pitch tolerance, with the pin hole (ØXA<sub>H7</sub>, depth 6) as the reference, without affecting mounting accuracy.
- \* For intermediate strokes other than standard strokes, refer to "Manufacture of Intermediate Strokes" on page 24.
- \* For bore size Ø16, only M5 x 0.8 port is available.
- \* For bore size Ø20 or more, choice of Rc, NPT, G port is available. (Refer to page 23.)

### MGPM, MGPL Common Dimensions

Bore size [mm]	Standard stroke [mm]	B	C	DA	FA	FB	G	GA	GB	H	HA	J	K	L	MM	ML	NN	OA	OB	OL	P		
																					—	TN	TF
16	25, 50, 75, 100, 125, 150, 175, 200, 250	71	58	8	7	6	30	10.5	7.5	64	M4	15	15	22	M5 x 0.8	12	M5 x 0.8	4.3	8	4.5	M5 x 0.8	—	—
20	25, 50, 75, 100, 125, 150, 175	78	62	10	8	8	36	11.5	9	83	M5	18	18	24	M5 x 0.8	13	M5 x 0.8	5.4	9.5	5.5	Rc1/8	NPT1/8	G1/8
25	200, 250, 300, 350, 400	78.5	62.5	10	9	7	42	11.5	10	93	M5	21	21	30	M6 x 1.0	15	M6 x 1.0	5.4	9.5	5.5	Rc1/8	NPT1/8	G1/8

Bore size [mm]	PA	PB	PW	Q	R	S	T	U	VA	VB	WA			WB			X	XA	XB	YY	YL	Z		
											75 st or less	100 to 175 st	200, 250 st	300 st or more	75 st or less	100 to 175 st							200, 250 st	300 st or more
16	39.5	10	19	16	54	25	62	46	56	38	44	110	200	—	27	60	105	—	24	3	3.5	M5 x 0.8	10	5
20	38.5	10.5	25	18	70	30	81	54	72	44	44	120	200	300	39	77	117	167	28	3	3.5	M6 x 1.0	12	17
25	37.5	13.5	30	26	78	38	91	64	82	50	44	120	200	300	39	77	117	167	34	4	4.5	M6 x 1.0	12	17

### MGPM (Slide bearing)/A, DB, E Dimensions

Bore size [mm]	A			DB	E		
	25 to 100 st	125 to 200 st	250 st or more		25 to 100 st	125 to 200 st	250 st or more
16	71	92.5	92.5	10	0	21.5	21.5
20	78	78	110	12	0	0	32
25	78.5	78.5	109.5	16	0	0	31

### MGPL (Ball bushing)

### MGPA (High precision ball bushing)/A, DB, E Dimensions

Bore size [mm]	A			DB	E		
	25 to 75 st	100 to 200 st	250 st or more		25 to 75 st	100 to 200 st	250 st or more
16	71	94.5	94.5	8	0	23.5	23.5
20	78	100	117.5	10	0	22	39.5
25	81.5	100.5	117.5	13	3	22	39

**Ø32 to Ø63/MGPM, MGPL, MGPA (With Air Cushion)**

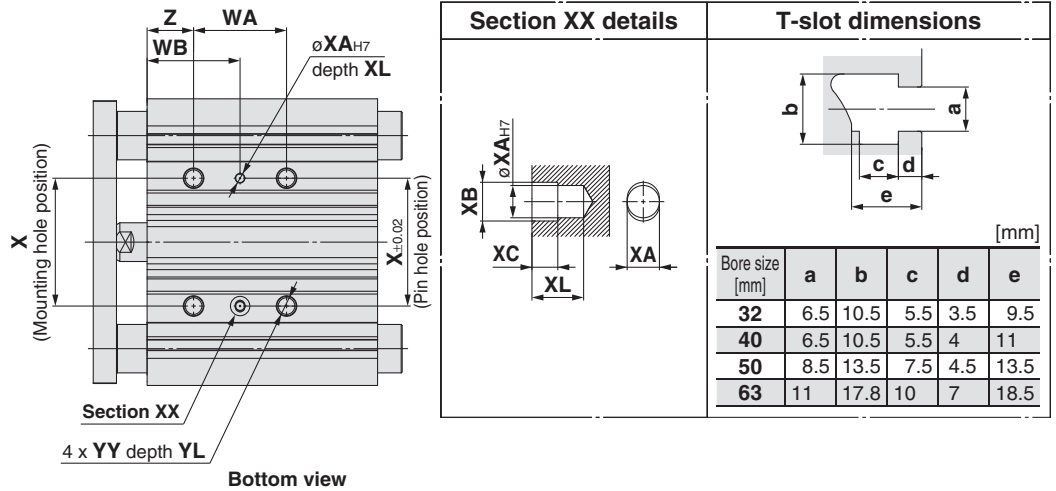

Basic Type **MGP**  
With Air Cushion **MGP**  
Auto Switch  
Made to Order

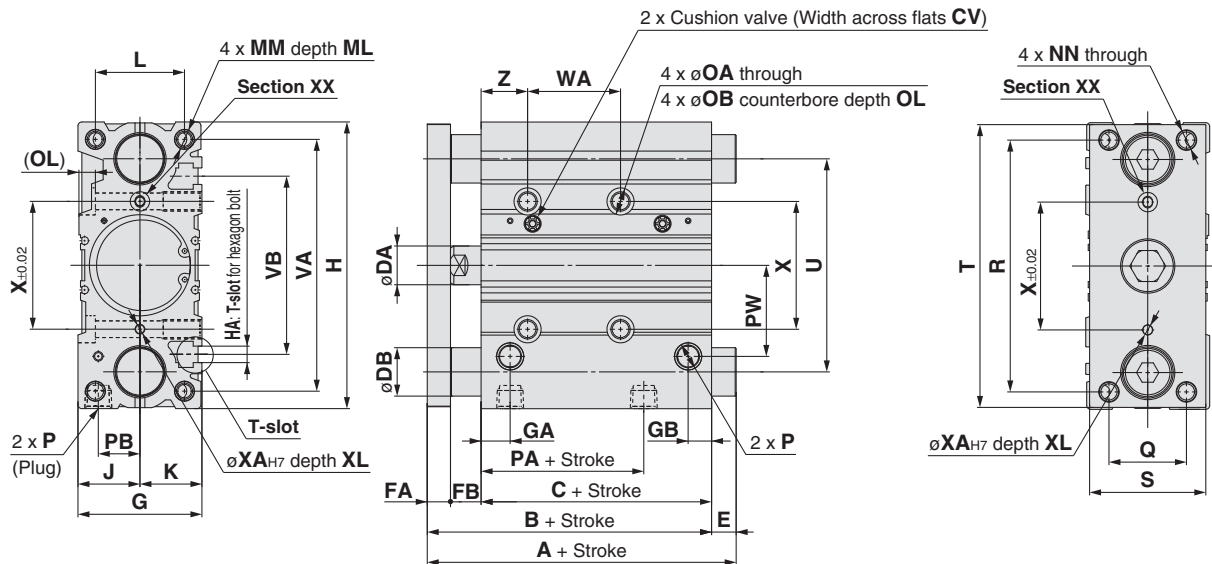

- \* The use of a slot (width XA, length XB, depth XC) allows for a relaxed pin pitch tolerance, with the pin hole (ØXA<sub>H7</sub>, depth XL) as the reference, without affecting mounting accuracy.
- \* For intermediate strokes other than standard strokes, refer to "Manufacture of Intermediate Strokes" on page 24.
- \* Choice of Rc, NPT, G port is available. (Refer to page 23.)

**MGPM, MGPL Common Dimensions**

Bore size [mm]	Standard stroke [mm]	B	C	CV	DA	FA	FB	G	GA	GB	H	HA	J	K	L	MM	ML	NN	OA	OB	OL	P		
																						—	TN	TF
32	25, 50, 75, 100	84.5	62.5	1.5	14	10	12	48	12	9	112	M6	24	24	34	M8 x 1.25	20	M8 x 1.25	6.7	11	7.5	Rc1/8	NPT1/8	G1/8
40	125, 150, 175	91	69	1.5	14	10	12	54	15	12	120	M6	27	27	40	M8 x 1.25	20	M8 x 1.25	6.7	11	7.5	Rc1/8	NPT1/8	G1/8
50	200, 250, 300	97	69	3	20	12	16	64	15	12	148	M8	32	32	46	M10 x 1.5	22	M10 x 1.5	8.6	14	9	Rc1/4	NPT1/4	G1/4
63	350, 400	102	74	3	20	12	16	78	15.5	13.5	162	M10	39	39	58	M10 x 1.5	22	M10 x 1.5	8.6	—	9	Rc1/4	NPT1/4	G1/4

Bore size [mm]	PA	PB	PW	Q	R	S	T	U	VA	VB	WA				WB				X	XA	XB	XC	XL	YY	YL	Z
											75 st or less	100 to 175 st	200, 250 st	300 st or more	75 st or less	100 to 175 st	200, 250 st	300 st or more								
32	31.5	16	35.5	30	96	44	110	78	98	63	48	124	200	300	45	83	121	171	42	4	4.5	3	6	M8 x 1.25	16	21
40	38	18	39.5	30	104	44	118	86	106	72	48	124	200	300	46	84	122	172	50	4	4.5	3	6	M8 x 1.25	16	22
50	34	21.5	47	40	130	60	146	110	130	92	48	124	200	300	48	86	124	174	66	5	6	4	8	M10 x 1.5	20	24
63	38	28	58	50	130	70	158	124	142	110	52	128	200	300	50	88	124	174	80	5	6	4	8	M10 x 1.5	20	24

**MGPL (Ball bushing)**

**MGPM (Slide bearing)/A, DB, E Dimensions [mm]**

**MGPA (High precision ball bushing)/A, DB, E Dimensions [mm]**

Bore size [mm]	A			DB	E		
	25 st	50 to 200 st	250 st or more		25 st	50 to 200 st	250 st or more
32	84.5	93.5	129.5	20	0	9	45
40	91	93.5	129.5	20	0	2.5	38.5
50	97	109.5	150.5	25	0	12.5	53.5
63	102	109.5	150.5	25	0	7.5	48.5

Bore size [mm]	A				DB	E			
	25 st	50, 75 st	100 to 200 st	250 st or more		25 st	50, 75 st	100 to 200 st	250 st or more
32	84.5	96.5	116.5	138.5	16	0	12	32	54
40	91	96.5	116.5	138.5	16	0	5.5	25.5	47.5
50	97	112.5	132.5	159.5	20	0	15.5	35.5	62.5
63	102	112.5	132.5	159.5	20	0	10.5	30.5	57.5

# Series MGP

## Ø80, Ø100/MGPM, MGPL, MGPA (With Air Cushion)

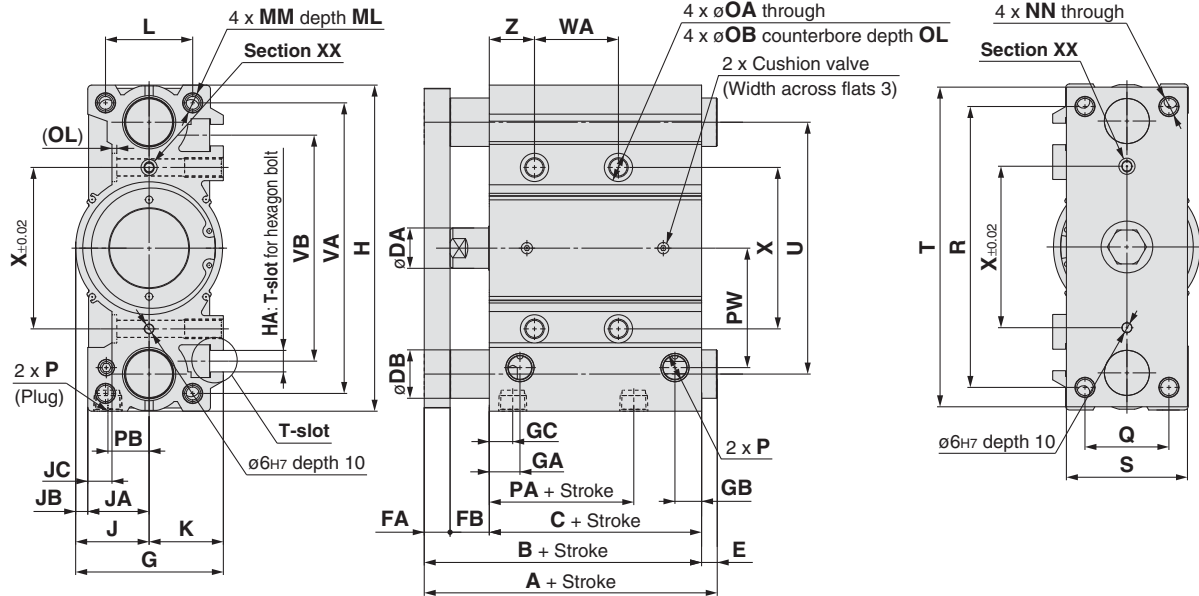
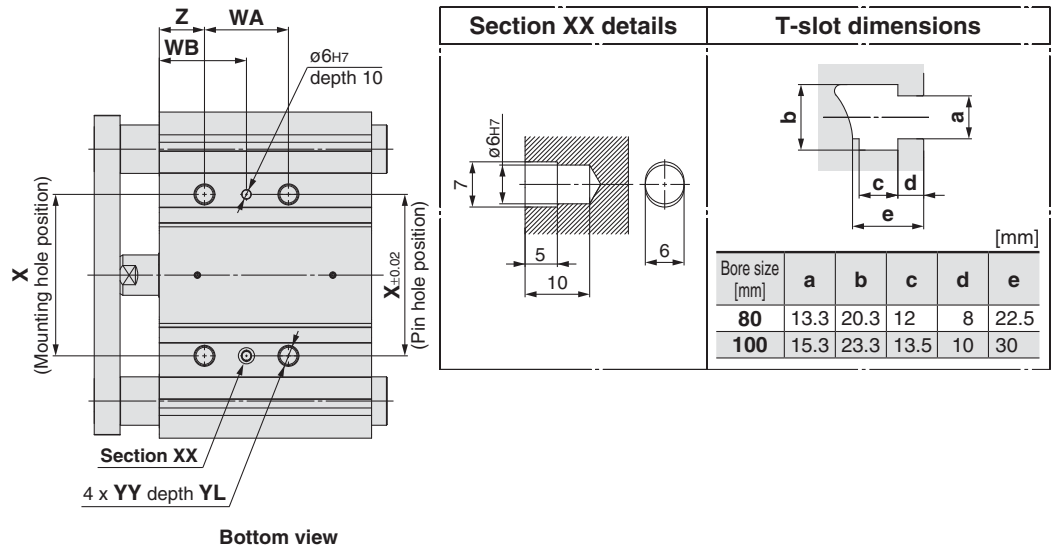

- \* The use of a slot (width X6, length 7, depth 5) allows for a relaxed pin pitch tolerance, with the pin hole (Ø6H7, depth 10) as the reference, without affecting mounting accuracy.
- \* For intermediate strokes other than standard strokes, refer to "Manufacture of Intermediate Strokes" on page 24.
- \* Choice of Rc, NPT, G port is available. (Refer to page 23.)

### MGPM, MGPL Common Dimensions [mm]

Bore size [mm]	Standard stroke [mm]	B	C	DA	FA	FB	G	GA	GB	GC	H	HA	J	JA	JB	JC	K	L	MM	ML	NN	OA	OB	OL	P		
																									—	TN	TF
80	50, 75, 100, 125, 150, 175	121.5	81.5	25	16	24	91.5	19	16.5	14.5	202	M12	45.5	38	7.5	15	46	54	M12 x 1.75	25	M12 x 1.75	10.6	17.5	3	Rc3/8	NPT3/8	G3/8
100	200, 250, 300, 350, 400	141	91	30	19	31	111.5	22.5	20.5	18	240	M14	55.5	45	10.5	10	56	62	M14 x 2.0	31	M14 x 2.0	12.5	20	8	Rc3/8	NPT3/8	G3/8

Bore size [mm]	PA	PB	PW	Q	R	S	T	U	VA	VB	WA				WB				X	YY	YL	Z
											50, 75 st	100 to 175 st	200, 250 st	300 st or more	50, 75 st	100 to 175 st	200, 250 st	300 st or more				
80	39.5	25.5	74	52	174	75	198	156	180	140	52	128	200	300	54	92	128	178	100	M12 x 1.75	24	28
100	42.5	32.5	89	64	210	90	236	188	210	166	72	148	220	320	47	85	121	171	124	M14 x 2.0	28	11

MGPM (Slide bearing)/A, DB, E Dimensions [mm]						MGPL (Ball bushing) MGPA (High precision ball bushing)/A, DB, E Dimensions [mm]					
Bore size [mm]	A		DB	E		Bore size [mm]	A		DB	E	
	50 to 200 st	250 st or more		50 to 200 st	250 st or more		50 to 200 st	250 st or more		50 to 200 st	250 st or more
80	131.5	180.5	30	10	59	80	158.5	191.5	25	37	70
100	151.5	190.5	36	10.5	49.5	100	178.5	201.5	30	37.5	60.5

# Series MGP

## Auto Switch Mounting

### Auto Switch Proper Mounting Position (Detection at stroke end) and Its Mounting Height

D-M9□/M9□V  
 D-M9□W/M9□WV  
 D-M9□A/M9□AV  
 D-A9□/A9□V

D-P3DWA

∅12 to ∅100

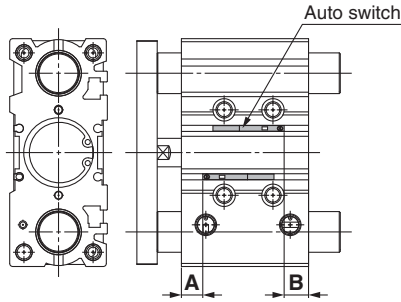

∅80, ∅100

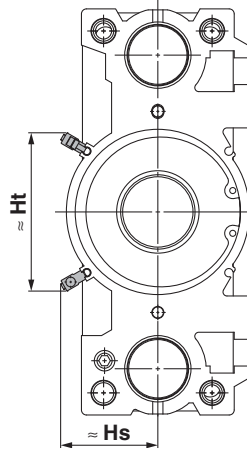

∅25 to ∅63

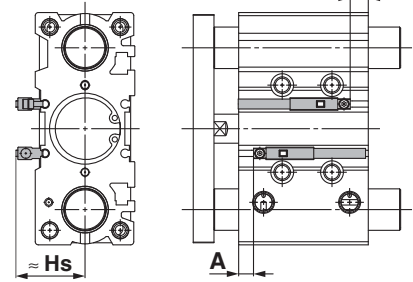

### Auto Switch Proper Mounting Position Applicable Cylinder Series: MGP

[mm]

Auto switch model	D-M9□ D-M9□V D-M9□W D-M9□WV D-M9□A D-M9□AV		D-A9□ D-A9□V		D-P3DWA	
	A	B	A	B	A	B
Bore size						
12	7.5	9.5	3.5	5.5	—	—
16	10.5	10.5	6.5	6.5	—	—
20	12.5	12.5	8.5	8.5	—	—
25	11.5	14	7.5	10	7	9.5
32	12.5	13	8.5	9	8	8.5
40	15.5	16.5	11.5	12.5	11	12
50	14.5	17	10.5	13	10	12.5
63	16.5	20	12.5	16	12	15.5
80	18	26	14	22	13.5	21.5
100	21.5	32.5	17.5	28.5	17	28

Note) Adjust the auto switch after confirming the operating conditions in the actual setting.

### Auto Switch Proper Mounting Height

[mm]

Auto switch model	D-M9□V D-M9□WV D-M9□AV		D-A9□V		D-P3DWA	
	Hs	Ht	Hs	Ht	Hs	Ht
Bore size						
12	19.5	—	17	—	—	—
16	22	—	19.5	—	—	—
20	24.5	—	22	—	—	—
25	26	—	24	—	32.5	—
32	29	—	26.5	—	35	—
40	33	—	30.5	—	39	—
50	38.5	—	36	—	44.5	—
63	45.5	—	43	—	59.5	—
80	45	74	43	71.5	48.5	84
100	55	85.5	53	83	58.5	95

### Auto Switch Proper Mounting Position Applicable Cylinder Series: MGP-A (With air cushion)

[mm]

Auto switch model	D-M9□ D-M9□V D-M9□W D-M9□WV D-M9□A D-M9□AV		D-A9□ D-A9□V		D-P3DWA	
	A	B	A	B	A	B
Bore size						
16	25	20.5	21	16.5	—	—
20	27	23	23	19	—	—
25	27	23	23	19	22.5	18.5
32	21	29	17	25	16.5	24.5
40	25.5	31.5	21.5	27.5	21	27
50	26	30.5	22	26.5	21.5	26
63	30	31.5	26	27.5	25.5	27
80	30.5	38.5	26.5	34.5	26	34
100	34.5	44	30.5	40	30	39.5

Basic Type

MGP

With Air Cushion

MGP

Auto Switch

Made to Order

## Minimum Stroke for Auto Switch Mounting

		[mm]										
Auto switch model	Number of auto switches	ø12	ø16	ø20	ø25	ø32	ø40	ø50	ø63	ø80	ø100	
<b>D-M9□V</b>	1 pc.						5					
	2 pcs.						5					
<b>D-M9□</b>	1 pc.	5 Note 1)				5						
	2 pcs.	10 Note 1)						10				
<b>D-M9□W</b>	1 pc.						5 Note 2)					
	2 pcs.	10 Note 2)						10				
<b>D-M9□WV</b> <b>D-M9□AV</b>	1 pc.						5 Note 2)					
	2 pcs.						10					
<b>D-M9□A</b>	1 pc.						5 Note 2)					
	2 pcs.						10 Note 2)					
<b>D-A9□</b>	1 pc.	5 Note 1)			5							
	2 pcs.	10 Note 1)			10							
<b>D-A9□V</b>	1 pc.						5					
	2 pcs.						10					
<b>D-P3DWA</b>	1 pc.	—			15							
	2 pcs.	—			15							

Note 1) Confirm that it is possible to secure the minimum bending radius of 10 mm of the auto switch lead wire before use.

Note 2) Confirm that it is possible to securely set the auto switch(es) within the range of indicator green light ON range before use.

For in-line entry type, also consider Note 1) shown above.

Note 3) The D-P3DWA is mountable on bore size ø25 to ø100.

## Operating Range

Auto switch model	Bore size									
	12	16	20	25	32	40	50	63	80	100
<b>D-M9□/M9□V</b> <b>D-M9□W/M9□WV</b> <b>D-M9□A/M9□AV</b>	3.5	5	5	5	6	6	6	6.5	6	7
<b>D-A9□/A9□V</b>	7	9	9	9	9.5	9.5	9.5	11	10.5	10.5
<b>D-P3DWA</b>	—	—	—	5	6	6	6	6	6	7

\* Values which include hysteresis are for guideline purposes only, they are not a guarantee (assuming approximately ±30% dispersion) and may change substantially depending on the ambient environment.

**Other than the applicable auto switches listed in “How to Order”, the following auto switches are mountable.**

Consult **SMC** for detailed specifications.

Type	Model	Electrical entry	Features
<b>Solid state</b>	D-P4DW	Grommet (In-line)	Magnetic field resistant (2-colour display) Bore size: ø32 to ø100

\* With pre-wired connector is also available for solid state auto switches.

For details, consult **SMC**.

\* Normally closed (NC = b contact) solid state auto switches (D-F9G/F9H) are also available.

For details, consult **SMC**.

\* When installing the D-P4DW, use the BMG7-032 auto switch mounting bracket.

## Auto Switch Mounting Brackets/Part No.

Applicable Cylinder Series: MGPM, MGPL, MGPA, MGPM-A, MGPL-A, MGPA-A

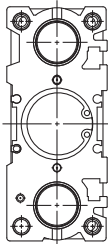
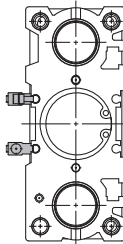
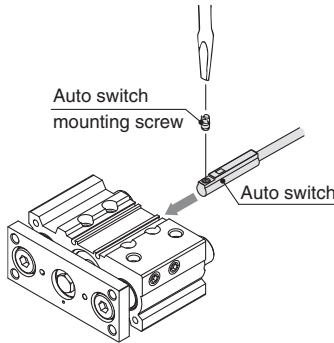
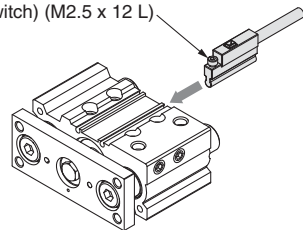
Applicable auto switches	D-M9□/M9□V D-M9□W/M9□WV D-M9□A/M9□AV D-A9□/A9□V	D-P3DWA								
Bore size [mm]	ø12 to ø100	ø25 to ø100								
Auto switch mounting surfaces	Surfaces with auto switch mounting slot	Surfaces with auto switch mounting slot								
										
Mounting of auto switch	<div style="text-align: center;">  <p>Auto switch mounting screw</p> <p>Auto switch</p> </div> <ul style="list-style-type: none"> <li>When tightening the auto switch mounting screw, use a watchmakers' screwdriver with a handle 5 to 6 mm in diameter.</li> </ul> <p><b>Tightening Torque for Auto Switch Mounting Screw</b> [N·m]</p> <table border="1" style="width: 100%; border-collapse: collapse;"> <thead> <tr> <th style="width: 60%;">Auto switch model</th> <th style="width: 40%;">Tightening torque</th> </tr> </thead> <tbody> <tr> <td>D-M9□(V)</td> <td rowspan="3" style="text-align: center;">0.05 to 0.15</td> </tr> <tr> <td>D-M9□W(V)</td> </tr> <tr> <td>D-M9□A(V)</td> </tr> <tr> <td>D-A9□(V)</td> <td style="text-align: center;">0.10 to 0.20</td> </tr> </tbody> </table>	Auto switch model	Tightening torque	D-M9□(V)	0.05 to 0.15	D-M9□W(V)	D-M9□A(V)	D-A9□(V)	0.10 to 0.20	<ol style="list-style-type: none"> <li>Insert the mounting bracket into the mating groove of the cylinder tube.</li> <li>Check the detecting position of the auto switch and fix the auto switch firmly with the hexagon socket head cap screw (M2.5 x 12 L).*</li> <li>If the detecting position is changed, go back to step ①.</li> </ol> <p>Note 1) Ensure that the auto switch is covered with the mating groove to protect the auto switch.</p> <p>Note 2) The tightening torque for the hexagon socket head cap screw (M2.5 x 12 L) is 0.2 to 0.3 N·m.</p> <div style="text-align: center;"> <p>Hexagon socket head cap screw (Included with auto switch) (M2.5 x 12 L)</p>  </div>
Auto switch model	Tightening torque									
D-M9□(V)	0.05 to 0.15									
D-M9□W(V)										
D-M9□A(V)										
D-A9□(V)	0.10 to 0.20									

Note) Auto switch mounting brackets and auto switches are enclosed with the cylinder for shipment.  
 For an environment that needs the water-resistant auto switch, select the D-M9□A(V) type.

Basic Type

MGP

With Air Cushion

MGP

Auto Switch

Auto Switch

Made to Order

Made to Order

# Prior to Use

## Auto Switch Connection and Example

### Sink Input Specifications

#### 3-wire, NPN

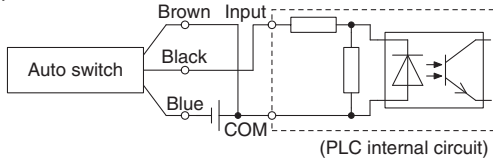

#### 2-wire

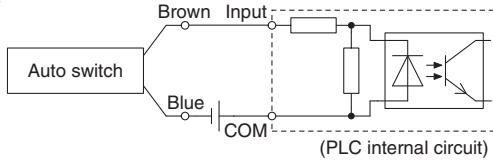

### Source Input Specifications

#### 3-wire, PNP

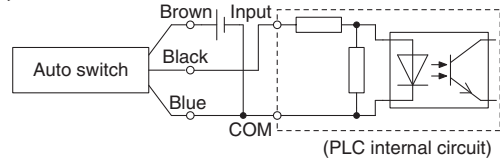

#### 2-wire

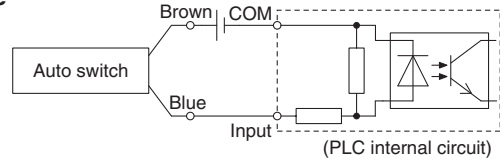

Connect according to the applicable PLC input specifications, as the connection method will vary depending on the PLC input specifications.

### Example of AND (Series) and OR (Parallel) Connection

\* When using solid state auto switches, ensure the application is set up so the signals for the first 50 ms are invalid.

#### 3-wire AND connection for NPN output

(Using relays)

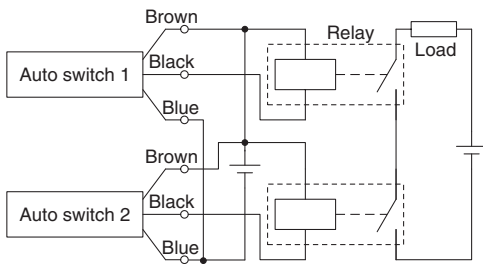

(Performed with auto switches only)

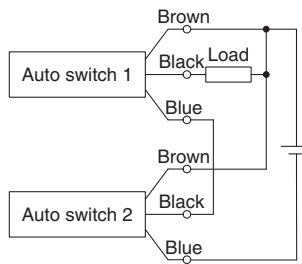

#### 3-wire OR connection for NPN output

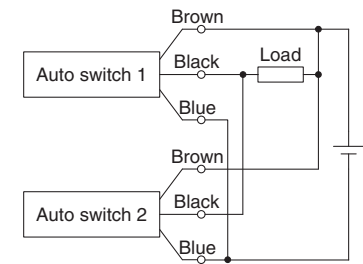

#### 3-wire AND connection for PNP output

(Using relays)

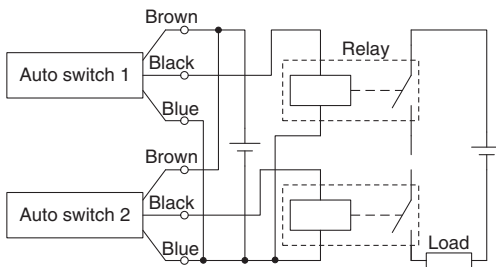

(Performed with auto switches only)

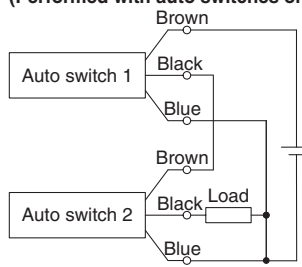

#### 3-wire OR connection for PNP output

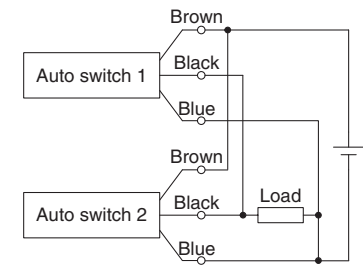

#### 2-wire AND connection

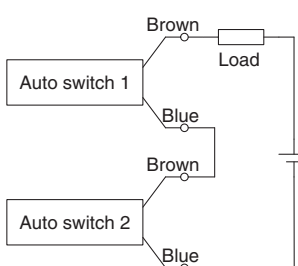

When two auto switches are connected in series, a load may malfunction because the load voltage will decline when in the ON state. The indicator lights will light up when both of the auto switches are in the ON state. Auto switches with load voltage less than 20 V cannot be used.

$$\begin{aligned} \text{Load voltage at ON} &= \text{Power supply voltage} - \\ &\quad \text{Residual voltage} \times 2 \text{ pcs.} \\ &= 24 \text{ V} - 4 \text{ V} \times 2 \text{ pcs.} \\ &= 16 \text{ V} \end{aligned}$$

Example: Power supply is 24 VDC  
Internal voltage drop in auto switch is 4 V.

#### 2-wire OR connection

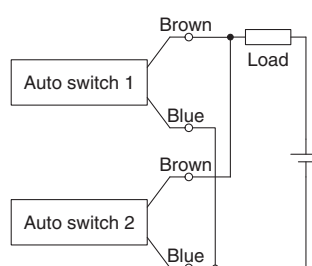

(Solid state)  
When two auto switches are connected in parallel, malfunction may occur because the load voltage will increase when in the OFF state.

(Reed)  
Because there is no current leakage, the load voltage will not increase when turned OFF. However, depending on the number of auto switches in the ON state, the indicator lights may sometimes grow dim or not light up, due to the dispersion and reduction of the current flowing to the auto switches.

$$\begin{aligned} \text{Load voltage at OFF} &= \text{Leakage current} \times 2 \text{ pcs.} \times \\ &\quad \text{Load impedance} \\ &= 1 \text{ mA} \times 2 \text{ pcs.} \times 3 \text{ k}\Omega \\ &= 6 \text{ V} \end{aligned}$$

Example: Load impedance is 3 k $\Omega$ .  
Leakage current from auto switch is 1 mA.





## Simple Specials

The following special specifications can be ordered as a simplified Made-to-Order. There is a specification sheet available on paper and CD-ROM. Please contact your SMC sales representatives if necessary.

Symbol	Specifications	Basic type			With air cushion			Page
		Slide bearing	Ball bushing	High precision ball bushing	Slide bearing	Ball bushing	High precision ball bushing	
		MGPM	MGPL	MGPA	MGPM	MGPL	MGPA	
-XA□	Change of guide rod end shape	●	●	●				Page 45
-XC79	Tapped hole, drilled hole, pinned hole machined additionally	●	●	●	●	●	●	Page 46

## Made to Order

Symbol	Specifications	Basic type			With air cushion			Page
		Slide bearing	Ball bushing	High precision ball bushing	Slide bearing	Ball bushing	High precision ball bushing	
		MGPM	MGPL	MGPA	MGPM	MGPL	MGPA	
-XB6	Heat resistant cylinder (-10 to 150°C)	●						Page 47
-XB10	Intermediate stroke (Using exclusive body)	●	●	●				Page 47
-XB13	Low speed cylinder (5 to 50 mm/s)	●	●					Page 48
-XC4	With heavy duty scraper	●	●	●				Page 49
-XC6	Made of stainless steel	●	●					Page 50
-XC8	Adjustable stroke cylinder/Adjustable extension type	●	●	●				Page 50
-XC9	Adjustable stroke cylinder/Adjustable retraction type	●	●	●				Page 51
-XC19	Intermediate stroke (Spacer type)				●	●	●	Page 52
-XC22	Fluororubber seal	●						Page 52
-XC35	With coil scraper	●	●	●				Page 53
-XC82	Bottom mounting type	●						Page 54
-XC85	Grease for food processing equipment	●	●	●	●	●	●	Page 54
-X144	Symmetrical port position	●	●	●				Page 55
-X867	Side porting type (Plug location changed)	●	●	●	●	●	●	Page 55

Basic Type

MGP

With Air Cushion

MGP

Auto Switch

Made to Order

# Series MGP

## Simple Specials

These changes are dealt with Simple Specials System.  
For details, refer to the **WEB catalogue** or the Best Pneumatics No. 3.



Symbol

### 1 Change of Guide Rod End Shape

**-XA1/6/17/21**

#### Applicable Series

Series	Model	Bearing type	Symbol for change of rod end shape
MGP-Z	Standard type	MGPM	Slide bearing
		MGPL	Ball bushing
		MGPA	High precision ball bushing
			XA1, 6, 17, 21
			XA1, 6

#### Precautions

- Ensure that the cylinder's overall length should not exceed the allowable overall length. In the case of exceeding the allowable overall length, it will be available as specials.
- In Fig. (1), (2) below, E' dimension cannot make it into E dimension or less of the standard products. Confirm by referring to catalogue.
- SMC will make appropriate arrangements if no dimension, tolerance, or finish instructions are given in the diagram.
- \* dimension should be the guide rod diameter (D) – 2 mm. In the case that the preferred dimension is different, fill in that dimension.

[mm]	
Bore size	Allowable overall length of cylinder
12,16	345
20 to 32	540
40 to 63	561
80,100	603

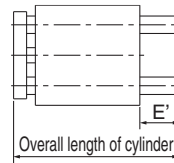

Fig. (1) XA1, XA6

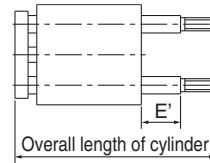

Fig. (2) XA17, XA21

#### Guide Rod End Shape Pattern

<b>-XA1</b>	<b>-XA6</b>
<b>-XA17</b>	<b>-XA21</b>

**2 Tapped Hole, Drilled Hole, Pinned Hole Machined Additionally**

Symbol  
**-XC79**

This simple special is meant for machining additionally tapped hole, drilled hole, and pinned hole, as requested from customer, on parts designed largely for mounting a workpiece etc. in the combined air cylinders.  
But, for each model, since they have the portions which are impossible to machine additionally, refer to the additional machining limitation.

**Applicable Series**

Series	Model	Bearing type	Component parts applicable for additional machining
<b>MGP-Z</b>	Standard type	MGPM	Slide bearing
		MGPL	Ball bushing
		MGPA	High precision ball bushing
	With air cushion	MGPM	Slide bearing
		MGPL	Ball bushing
		MGPA	High precision ball bushing
			Plate

**Precautions**

- We cannot take any responsibility as for the intensity of holes machined additionally and the effects of decreased intensity for the product itself.
- It will not be plated again for the machined part additionally.
- Be sure to fill in "through" for through-hole, and "effective depth" for blind hole.
- When using by machining through-hole additionally, ensure that the tip of the bolt etc. for mounting workpiece should not stick into the cylinder side. It may result in an unexpected problem.
- Use caution not to interfere the existing mounting hole on the standard products with the hole to be machined additionally. But it is possible to drill additionally the larger size of hole at the same position as the existing hole.

**Common Complementary Explanation/Holes which can be additionally machined are the following 3 types.**

Tapped hole	Drilled hole	Pinned hole												
<p>Designated nominal diameter and tapped hole of a pitch are machined additionally. (Maximum nominal thread diameter M20) Blind hole is deep into the bottom of prepared hole which sums up A to C in the figure below in contrast to the effective depth of tapped hole. When there is a condition which does not allow through-hole etc., leave sufficient thickness in the inner part of hole.</p>	<p>Drilled hole of a designated internal diameter is machined. (Maximum hole diameter 20 mm) If you wish for blind hole, instruct us with effective depth. (Refer to the figure below.) Besides, dimensional accuracy for internal diameter will be ±0.2 mm.</p>	<p>Pinned hole of a designated diameter (reamer hole) is machined. (Maximum hole diameter 20 mm) Internal dimension tolerates H7 tolerance to the designated hole diameter. (Refer to the table below.)</p> <table border="1"> <thead> <tr> <th>Hole dia.</th> <th>3 or less</th> <th>Over 3 to 6</th> <th>Over 6 to 10</th> <th>Over 10 to 18</th> <th>Over 18 to 20</th> </tr> </thead> <tbody> <tr> <td>Tolerance</td> <td>+0.01 0</td> <td>+0.012 0</td> <td>+0.015 0</td> <td>+0.018 0</td> <td>+0.021 0</td> </tr> </tbody> </table>	Hole dia.	3 or less	Over 3 to 6	Over 6 to 10	Over 10 to 18	Over 18 to 20	Tolerance	+0.01 0	+0.012 0	+0.015 0	+0.018 0	+0.021 0
Hole dia.	3 or less	Over 3 to 6	Over 6 to 10	Over 10 to 18	Over 18 to 20									
Tolerance	+0.01 0	+0.012 0	+0.015 0	+0.018 0	+0.021 0									

**Limitation for Machining Additionally** Since the slanted lines denote the restricted range for machining additionally, design the dimensions, referring to below.

Plate material: Steel

**Dimensional Range Not Possible to Machine Additionally** [mm]

Bore size	A	B	C
12	8	11	41
16	10	13	46
20	12	15	54
25	14	21	64
32	25	25	78
40	25	25	86
50	30	30	110
63	30	30	124
80	34	34	156
100	42	42	188

Basic Type  
MGP  
With Air Cushion  
MGP  
Auto Switch  
Made to Order

# Series MGP Made to Order

Please contact SMC for detailed dimensions, specifications and lead times.



## 1 Heat Resistant Cylinder (-10 to 150°C)

Symbol

**-XB6**

Air cylinder which changed the seal material and grease, so that it could be used even at higher temperature up to 150 from -10°C.

### Applicable Series

Series	Model	Bearing type
<b>MGP-Z</b>	Standard type	MGPM
		Slide bearing

- Note 1) Operate without lubrication from a pneumatic system lubricator.  
 Note 2) Please contact SMC for details on the maintenance intervals for this cylinder, which differ from those of the standard cylinder.  
 Note 3) In principle, it is impossible to make built-in magnet type and the one with auto switch. But, as for the one with auto switch, and the heat resistant cylinder with heat resistant auto switch, since it will be differed depending on the series, please contact SMC.  
 Note 4) Piston speed is ranged from 50 to 500 mm/s. But, for  $\phi 80$  and  $\phi 100$ , it will be 50 to 400 mm/s.  
 Note 5) No cushion is equipped. Check the kinetic energy.

### How to Order

**MGPM** Standard model no. **-XB6**  
 Heat resistant cylinder

### Warning

#### Precautions

Be aware that smoking cigarettes etc. after your hands have come into contact with the grease used in this cylinder can create a gas that is hazardous to humans.

### Specifications

<b>Ambient temperature range</b>	-10°C to 150°C
<b>Seal material</b>	Fluororubber
<b>Grease</b>	Heat resistant grease
<b>Specifications other than above</b>	Same as standard type

### Dimensions

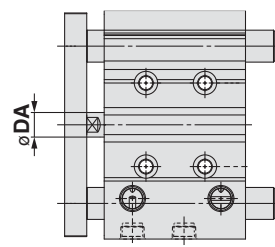

[mm]	
Bore size [mm]	DA
12	(6)
16	(8)
20	(10)
25	(10)
32	(14)
40	(14)
50	20
63	20
80	25
100	30

The dimensions in ( ) are the same as standard type.

## 2 Intermediate Stroke (Using exclusive body)

Symbol

**-XB10**

Cylinder which can reduce the mounting space by using an exclusive body which does not use a spacer to achieve that, the full length dimension could be shortened when an intermediate stroke other than the standard stroke is required.

### Applicable Series

Series	Model	Bearing type
<b>MGP-Z</b>	Standard type	MGPM
		MGPL
		MGPA
		Slide bearing
		Ball bushing
		High precision ball bushing

### How to Order

**MGP** <sup>M</sup><sub>L</sub><sub>A</sub> Standard model no. **-XB10**  
 Intermediate stroke

**Specifications: Same as standard type**

**2 Intermediate Stroke (Using exclusive body)**

Symbol  
**-XB10**

**Dimensions**

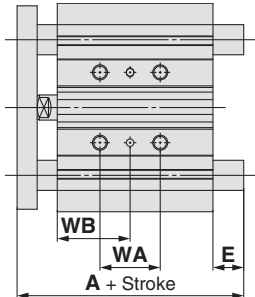

**Stroke Range**

Bore size [mm]	Stroke range [mm]
12, 16	11 to 249
20, 25	21 to 399
32, 40, 50, 63, 80, 100	26 to 399

\* Specifications except the stroke range are the same as standard.  
Note) Applicable stroke available by the 1 mm interval.

**MGPM, MGPL, MGPA/WA, WB Dimensions**

Bore size [mm]	Stroke range [mm]	WA				WB			
		11 to 39 st	41 to 99 st	101 to 199 st	201 to 249 st	11 to 39 st	41 to 99 st	101 to 199 st	201 to 249 st
12	11 to 249	20	40	110	200	15	25	60	105
16		24	44	110	200	17	27	60	105

Bore size [mm]	Stroke range [mm]	WA					WB				
		21 to 39 st	41 to 124 st	126 to 199 st	201 to 299 st	301 to 399 st	21 to 39 st	41 to 124 st	126 to 199 st	201 to 299 st	301 to 399 st
20	21 to 399	24	44	120	200	300	29	39	77	117	167
25		24	44	120	200	300	29	39	77	117	167

Bore size [mm]	Stroke range [mm]	WA					WB				
		26 to 49 st	51 to 124 st	126 to 199 st	201 to 299 st	301 to 399 st	26 to 49 st	51 to 124 st	126 to 199 st	201 to 299 st	301 to 399 st
32	26 to 399	24	48	124	200	300	33	45	83	121	171
40		24	48	124	200	300	34	46	84	122	172
50		24	48	124	200	300	36	48	86	124	174
63		28	52	128	200	300	38	50	88	124	174
80		28	52	128	200	300	42	54	92	128	178
100		48	72	148	220	320	35	47	85	121	171

**MGPM/A, E Dimensions**

Bore size [mm]	A			E		
	11 to 74 st	76 to 99 st	101 to 249 st	11 to 74 st	76 to 99 st	101 to 249 st
12	42	60.5	82.5	0	18.5	40.5
16	46	64.5	92.5	0	18.5	46.5

Bore size [mm]	A			E		
	21 to 74 st	76 to 199 st	201 to 399 st	21 to 74 st	76 to 199 st	201 to 399 st
20	53	77.5	110	0	24.5	57
25	53.5	77.5	109.5	0	24	56

Bore size [mm]	A			E		
	26 to 74 st	76 to 199 st	201 to 399 st	26 to 74 st	76 to 199 st	201 to 399 st
32	75	93.5	129.5	15.5	34	70
40	75	93.5	129.5	9	27.5	63.5
50	88.5	109.5	150.5	16.5	37.5	78.5
63	88.5	109.5	150.5	11.5	32.5	73.5
80	104.5	131.5	180.5	8	35	84
100	126.5	151.5	190.5	10.5	35.5	74.5

\* Dimensions except mentioned above are the same as standard type.

**MGPL, MGPA/A,E Dimensions**

Bore size [mm]	A			E		
	11 to 39 st	41 to 99 st	101 to 249 st	10 to 39 st	41 to 99 st	101 to 249 st
12	43	55	84.5	1	13	42.5
16	49	65	94.5	3	19	48.5

Bore size [mm]	A				E			
	21 to 39 st	41 to 124 st	126 to 199 st	201 to 399 st	21 to 39 st	41 to 124 st	126 to 199 st	201 to 399 st
20	59	76	100	117.5	6	23	47	64.5
25	65.5	81.5	100.5	117.5	12	28	47	64

Bore size [mm]	A				E			
	26 to 74 st	76 to 124 st	126 to 199 st	201 to 399 st	26 to 74 st	76 to 124 st	126 to 199 st	201 to 399 st
32	79.5	96.5	116.5	138.5	20	37	57	79
40	79.5	96.5	116.5	138.5	13.5	30.5	50.5	72.5
50	91.5	112.5	132.5	159.5	19.5	40.5	60.5	87.5
63	91.5	112.5	132.5	159.5	14.5	35.5	55.5	82.5

Bore size [mm]	A				E			
	26 to 49 st	51 to 74 st	76 to 199 st	201 to 399 st	26 to 49 st	51 to 74 st	76 to 199 st	201 to 399 st
80	104.5	128.5	158.5	191.5	8	32	62	95
100	119.5	145.5	178.5	201.5	3.5	29.5	62.5	85.5

**3 Low Speed Cylinder (5 to 50 mm/s)**

Symbol  
**-XB13**

Even if driving at lower speeds 5 to 50 mm/s, there would be no stick-slip phenomenon and it can run smoothly.

**Applicable Series**

Series	Model	Bearing type
MGP-Z	Standard type	MGPM
		MGPL

**How to Order**

MGP<sup>M</sup><sub>L</sub> Standard model no. -XB13  
 Low speed cylinder

**Specifications**

Piston speed	5 to 50 mm/s
Dimensions	Same as standard type
Specifications other than above	Same as standard type

Note 1) Operate without lubrication from a pneumatic system lubricator.  
 Note 2) For the speed adjustment, use speed controllers for controlling at lower speeds. (Series AS-FM/AS-M)

**Warning Precautions**

Be aware that smoking cigarettes etc. after your hands have come into contact with the grease used in this cylinder can create a gas that is hazardous to humans.

Basic Type MGP  
With Air Cushion MGP  
Auto Switch  
Made to Order

## 4 With Heavy Duty Scraper -XC4

It is suitable for using cylinders under the environment, where there are much dusts in a surrounding area by using a heavy duty scraper on the wiper ring, or using cylinders under earth and sand exposed to the die-casted equipment, construction machinery, or industrial vehicles.

### Applicable Series

Series	Model	Bearing type	
MGP-Z	Standard type	MGPM	Slide bearing
		MGPL	Ball bushing
		MGPA	High precision ball bushing

### How to Order

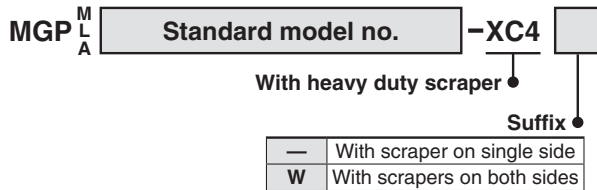

### Specifications

Applicable series	MGPM	MGPL/MGPA
<b>Bearing type</b>	Slide bearing	Ball bushing
<b>Bore size [mm]</b>	20, 25, 32, 40, 50, 63, 80, 100	
<b>Minimum operating pressure</b>	On single side	0.12 MPa
	On both sides	0.14 MPa
<b>Specifications other than above</b>	Same as standard type	

### ⚠ Caution

**Do not replace heavy duty scrapers.**

- Since heavy duty scrapers are press-fit, they must be replaced together with the holder plate assembly.

### Dimensions (Dimensions other than below are the same as standard type.)

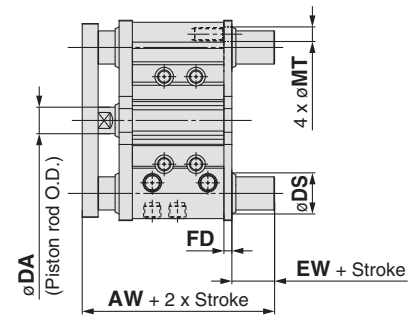
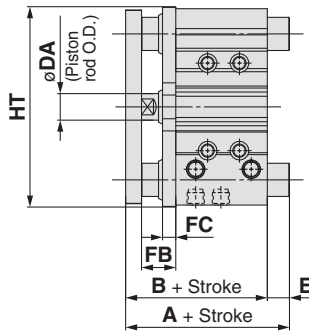

A cylinder with scrapers on both sides

### MGPM, MGPL, MGPA Common Dimensions [mm]

Bore size [mm]	B	DA	FB	FC	
				MGPM	MGPL MGPA
20	63	(10)	18	9	5
25	63.5	(10)	17	9	5
32	69.5	(14)	22	9	5
40	76	(14)	22	9	5
50	82	20	26	10	8
63	87	20	26	10	5
80	106.5	25	34	15	6
100	126	30	41	15	6

The dimensions in ( ) are the same as standard type.

### MGPM (Slide bearing)/A, E, HT Dimensions [mm]

Bore size [mm]	A			E			HT
	50 st or less	Over 50 st to 200 st	Over 200 st	50 st or less	Over 50 st to 200 st	Over 200 st	
20	63	87.5	120	0	24.5	57	80
25	63.5	87.5	119.5	0	24	56	93
32	85	103.5	139.5	15.5	34	70	111.5
40	85	103.5	139.5	9	27.5	63.5	119
50	98.5	119.5	160.5	16.5	37.5	78.5	151
63	98.5	119.5	160.5	11.5	32.5	73.5	165
80	114.5	141.5	190.5	8	35	84	202
100	136.5	161.5	200.5	10.5	35.5	74.5	240

### With Scrapers on Both Sides/AW, EW, FD, MT, DS Dimensions [mm]

Bore size [mm]	AW	EW	FD	MT	DS*	
					MGPM	MGPL MGPA
20	74	6	5	6	17	15
25	74.5	6	5	7	21	19
32	82.5	7	6	8.5	26	21
40	89	7	6	8.5	26	21
50	95	7	6	11	31	26
63	100	7	6	11	31	26
80	120.5	8	6	14	36	31
100	143	8	9	16	44	36

\* Bypass port for guide rod with bottom mounting

### MGPL, MGPA (Ball bushing)/A, E, HT Dimensions [mm]

Bore size [mm]	A				E				HT
	30 st or less	Over 30 st to 100 st	Over 100 st to 200 st	Over 200 st	30 st or less	Over 30 st to 100 st	Over 100 st to 200 st	Over 200 st	
20	69	86	110	127.5	6	23	47	64.5	80
25	75.5	91.5	110.5	127.5	12	28	47	64	93

Bore size [mm]	A				E				HT
	50 st or less	Over 50 st to 100 st	Over 100 st to 200 st	Over 200 st	50 st or less	Over 50 st to 100 st	Over 100 st to 200 st	Over 200 st	
32	89.5	106.5	126.5	148.5	20	37	57	79	110
40	89.5	106.5	126.5	148.5	13.5	30.5	50.5	72.5	118
50	101.5	122.5	142.5	169.5	19.5	40.5	60.5	87.5	146
63	101.5	122.5	142.5	169.5	14.5	35.5	55.5	82.5	160

Bore size [mm]	A				E				HT
	25 st or less	Over 25 st to 50 st	Over 50 st to 200 st	Over 200 st	25 st or less	Over 25 st to 50 st	Over 50 st to 200 st	Over 200 st	
80	114.5	138.5	168.5	201.5	8	32	62	95	199
100	129.5	155.5	188.5	211.5	3.5	29.5	62.5	85.5	236

**5 Made of Stainless Steel**

Symbol  
**-XC6**

Suitable for the cases it is likely to generate rust by being immersed in the water and corrosion.

**Applicable Series**

Series	Model	Bearing type	
MGP-Z	Standard type	MGPM	Slide bearing
		MGPL	Ball bushing

**Specifications**

Parts material changed to stainless steel	A	①, ②, ③, ④, ⑤, ⑥
	B	①, ②, ⑤, ⑥
Specifications other than above and external dimensions	Same as standard type	

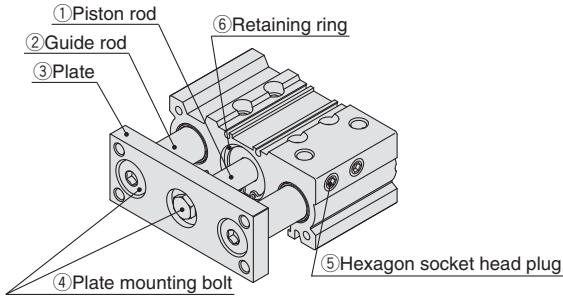

**How to Order**

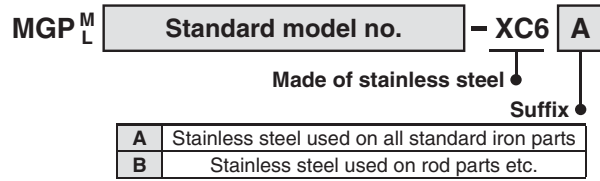

**Dimensions**

**MGPM, MGPL, -Z-XC6**  
Common Dimensions (mm)

Bore size [mm]	XC6A			XC6B
	DA	FA	FB	DA
12	(6)	8	5	(6)
16	(8)	8	5	(8)
20	(10)	9	7	(10)
25	(10)	10	6	(10)
32	(14)	12	10	(14)
40	(14)	12	10	(14)
50	20	16	12	20
63	20	16	12	20
80	25	19	21	25
100	30	22	28	30

The dimensions in ( ) are the same as standard type.

**6 Adjustable Stroke Cylinder/Adjustable Extension Type**

Symbol  
**-XC8**

It adjusts the extending stroke by the stroke adjustable mechanism equipped in the head side. (After the stroke is adjusted, with cushion on both sides is altered to single-sided, with cushion.)

**Applicable Series**

Series	Model	Bearing type	
MGP-Z	Standard type	MGPM	Slide bearing
		MGPL	Ball bushing
		MGPA	High precision ball bushing

**How to Order**



**Precautions**

**Warning**

- When the cylinder is operating, if something gets caught between the stopper bracket for adjusting the stroke and the cylinder body, it could cause bodily injury or damage the peripheral equipment. Therefore, take preventive measures as necessary, such as installing a protective cover.
- To adjust the stroke, make sure to secure the wrench flats of the stopper bracket by a wrench etc. before loosening the lock nut. If the lock nut is loosened without securing the stopper bracket, be aware that the area that joins the load to the piston rod or the area in which the piston rod is joined with the load side and the stopper bracket side could loosen first. It may cause an accident or malfunction.

**Symbol**

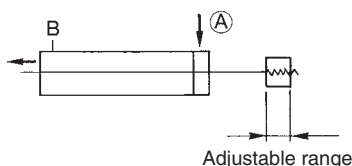

**Specifications**

Stroke adjustment symbol	A	B
Stroke adjustment range [mm]	0 to 10	0 to 25
Specifications other than above	Same as standard type	

**Dimensions** (Dimensions other than below are the same as standard type.)

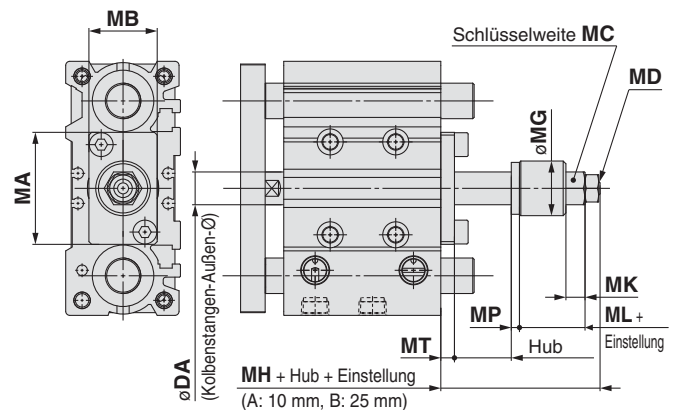

**MGPM, MGPL, MGPA Common Dimensions** [mm]

Bore size [mm]	DA	MA	MB	MC	MD	øMG	MH	MK	ML	MP	MT
12	(6)	27	13	8	M4 x 0.7	14	20	5.5	10	3	3
16	(8)	28	16	10	M5 x 0.8	14	20	5.5	10	3	3
20	(10)	33	22	12	M6 x 1	20	26	7	14	3	4
25	12	41	25	12	M6 x 1	20	27	7	14	3	5
32	16	51	32	17	M8 x 1.25	25	35	9	18.5	4	6
40	16	60	32	19	M10 x 1.25	25	35	10	17	4	6
50	20	71	38	24	M14 x 1.5	35	46	13	21	4	8
63	20	84	50	24	M14 x 1.5	35	46	13	21	4	8
80	25	114	50	32	M20 x 1.5	45	55	16	30	4	9
100	30	140	65	32	M20 x 1.5	45	58	16	30	4	12

The dimensions in ( ) are the same as standard type.

Basic Type MGP  
With Air Cushion MGP  
Auto Switch  
Made to Order

## 7 Adjustable Stroke Cylinder/Adjustable Retraction Type

The retract stroke of the cylinder can be adjusted by the adjustment bolt.

### Applicable Series

Series	Model	Bearing type	
MGP-Z	Standard type	MGPM	Slide bearing
		MGPL	Ball bushing
		MGPA	High precision ball bushing

### How to Order

MGP<sup>M</sup><sub>L</sub><sub>A</sub> **Bore size** - **Stroke** **Stroke adjustment symbol** Z - XC9  
Adjustable stroke cylinder/Adjustable retraction type

### Precautions

#### ⚠ Caution

- When air is supplied to the cylinder, if the stroke adjustment bolt is loosened in excess of the allowable stroke adjustment amount, be aware that the stroke adjustment bolt could fly out or air could be discharged, which could injure personnel or damage the peripheral equipment.
- Adjust the stroke when the cylinder is not pressurised. If it is adjusted in the pressurised state, the seal of the adjustment section could become deformed, leading to air leakage.

### Symbol

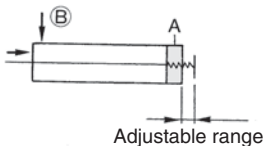

### Specifications

Stroke adjustment symbol	A	B
<b>Stroke adjustment range [mm]</b>	0 to 10	0 to 25
<b>Specifications other than above</b>	Same as standard type	

### Dimensions (Dimensions other than below are the same as standard type.)

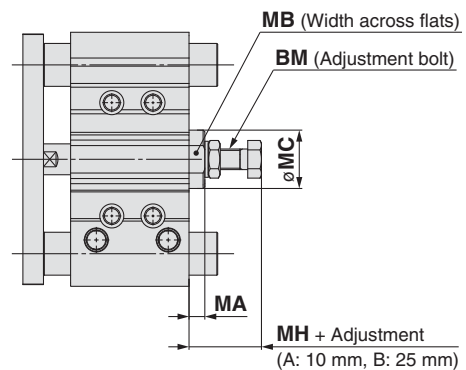

### MGPM, MGPL, MGPA Common Dimensions [mm]

Bore size [mm]	BM	MA	MB	MC	MH
12	M5 x 0.8	5	8	12.5	17
16	M6 x 1	5	10	14	19
20	M8 x 1.25	6.5	13	16	25
25	M8 x 1.25	6.5	13	16	24
32	M8 x 1.25	6.5	19	21	25
40	M12 x 1.5	9	27	30	32.5
50	M12 x 1.5	9	30	34	32.5
63	M16 x 1.5	10	36	40	37
80	M20 x 1.5	15	41	46	48.5
100	M24 x 1.5	18	46	52	55.5



## 8 Intermediate Stroke (Spacer type)

Symbol  
**-XC19**

Dealing with the intermediate stroke by installing a spacer with the standard stroke cylinder.

### Applicable Series

Series	Model	Bearing type	
MGP-Z	With air cushion	MGPM	Slide bearing
		MGPL	Ball bushing
		MGPA	High precision ball bushing

### How to Order

MGP<sup>M</sup><sub>L</sub><sub>A</sub> Standard model no. **-XC19**  
Intermediate stroke (Spacer type)

### Applicable Stroke

<b>Description</b>	Dealing with the stroke by the 1 mm interval by changing a collar of the standard stroke cylinder. Minimum manufacturable stroke Select a rubber bumper type, because the cushion effect is not obtainable for less than this stroke. ø16 to ø63: 15 mm ø80, ø100: 20 mm	
<b>Model no.</b>	Add "-XC19" to the end of standard part number.	
<b>Applicable stroke [mm]</b>	ø16	15 to 249
	ø20 to ø63	15 to 399
	ø80, ø100	20 to 399
<b>Example</b>	Part no.: MGPM20-35AZ-XC19 15 mm width collar is installed in MGPM20-50AZ. C dimension is 112 mm.	

Note) Intermediate strokes (by the 1 mm interval) with a special body are available as special products.

## 9 Fluororubber Seal

Symbol  
**-XC22**

### Applicable Series

Series	Model	Action	
MGP-Z	Standard type	MGPM	Double acting

### How to Order

MGPM Standard model no. **-XC22**  
Fluororubber seal

### Specifications

<b>Seal material</b>	Fluororubber
<b>Ambient temperature range</b>	With auto switch Note 1): -10°C to 60°C (No freezing)
<b>Specifications other than above</b>	Same as standard type

Note 1) Please confirm with SMC, as the type of chemical and the operating temperature may not allow the use of this product.  
 Note 2) No cushion is equipped. Check the kinetic energy.

### Dimensions

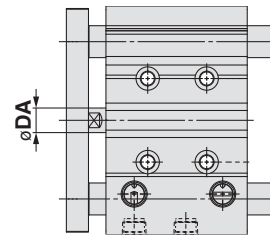

[mm]			
Bore size [mm]	DA	Bore size [mm]	DA
12	(6)	40	(14)
16	(8)	50	20
20	(10)	63	20
25	(10)	80	25
32	(14)	100	30

The dimensions in ( ) are the same as standard type.

Basic Type

MGP

With Air Cushion

MGP

Auto Switch

Made to Order

## 10 With Coil Scraper

It gets rid of frost, ice, weld spatter, cutting chips adhered to the piston rod, and protects the seals etc.

### Applicable Series

Series	Model	Bearing type	
MGP-Z	Standard type	MGPM	Slide bearing
		MGPL	Ball bushing
		MGPA	High precision ball bushing

### How to Order

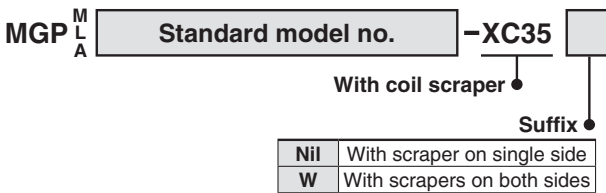

### Specifications

Applicable series		MGPM	MGPL/MGPA
Bearing type		Slide bearing	Ball bushing
Bore size [mm]		20, 25, 32, 40, 50, 63, 80, 100	
Minimum operating pressure	On single side	0.12 MPa	
	On both sides	0.14 MPa	
Specifications other than above		Same as standard type	

### Dimensions (Dimensions other than below are the same as standard type.)

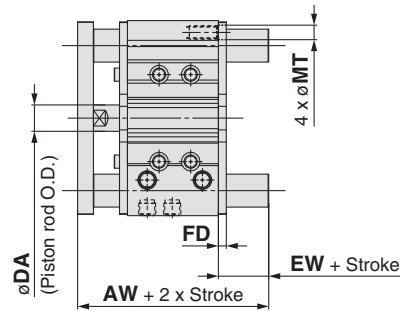
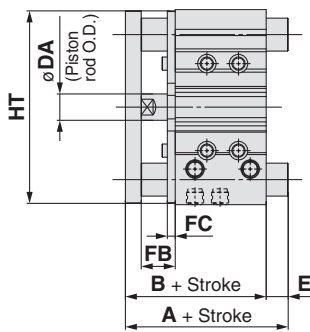

A cylinder with scrapers on both sides

### MGPM, MGPL, MGPA Common Dimensions [mm]

Bore size [mm]	B	DA	FB	FC	
				MGPM	MGPL MGPA
20	63	(10)	18	5	5
25	63.5	(10)	17	6	5
32	69.5	(14)	22	6	5
40	76	(14)	22	6	5
50	82	20	26	6	5
63	87	20	26	6	5
80	106.5	25	34	8	6
100	126	30	41	9	6

The dimensions in ( ) are the same as standard type.

### With Scrapers on Both Sides/AW, EW, FD, MT Dimensions [mm]

Bore size [mm]	AW	EW	FD	MT
20	74	6	5	6
25	74.5	6	5	7
32	82.5	7	6	9
40	89	7	6	8.5
50	95	7	6	11
63	100	7	6	11
80	120.5	8	6	14
100	143	8	9	16

### MGPM (Slide bearing)/A, E, HT Dimensions [mm]

Bore size [mm]	A			E			HT
	50 st or less	Over 50 st to 200 st	Over 200 st	50 st or less	Over 50 st to 200 st	Over 200 st	
20	63	87.5	120	0	24.5	57	80
25	63.5	87.5	119.5	0	24	56	93
32	85	103.5	139.5	15.5	34	70	110
40	85	103.5	139.5	9	27.5	63.5	118
50	98.5	119.5	160.5	16.5	37.5	78.5	146
63	98.5	119.5	160.5	11.5	32.5	73.5	160
80	114.5	141.5	190.5	8	35	84	199
100	136.5	161.5	200.5	10.5	35.5	74.5	236

### MGPL, MGPA (Ball bushing)/A, E, HT Dimensions [mm]

Bore size [mm]	A				E				HT
	30 st or less	Over 30 st to 100 st	Over 100 st to 200 st	Over 200 st	30 st or less	Over 30 st to 100 st	Over 100 st to 200 st	Over 200 st	
20	69	86	110	127.5	6	23	47	64.5	80
25	75.5	91.5	110.5	127.5	12	28	47	64	93

Bore size [mm]	A				E				HT
	50 st or less	Over 50 st to 100 st	Over 100 st to 200 st	Over 200 st	50 st or less	Over 50 st to 100 st	Over 100 st to 200 st	Over 200 st	
32	89.5	106.5	126.5	148.5	20	37	57	79	110
40	89.5	106.5	126.5	148.5	13.5	30.5	50.5	72.5	118
50	101.5	122.5	142.5	169.5	19.5	40.5	60.5	87.5	146
63	101.5	122.5	142.5	169.5	14.5	35.5	55.5	82.5	160

Bore size [mm]	A				E				HT
	25 st or less	Over 25 st to 50 st	Over 50 st to 200 st	Over 200 st	25 st or less	Over 25 st to 50 st	Over 50 st to 200 st	Over 200 st	
80	114.5	138.5	168.5	201.5	8	32	62	95	199
100	129.5	155.5	188.5	211.5	3.5	29.5	62.5	85.5	236

## 11 Bottom Mounting Type

Symbol  
**-XC82**

Since the guide rod does not protrude from the bottom at the retraction of the rod, relief holes for guide rods are not required.

### Applicable Series

Series	Model	Bearing type
MGP-Z	Standard type	MGPM
		Slide bearing

### How to Order

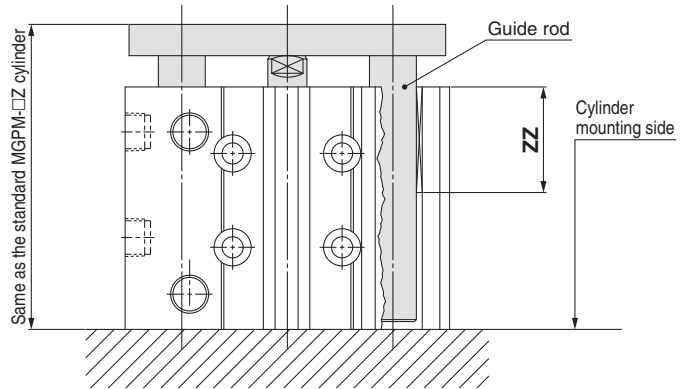
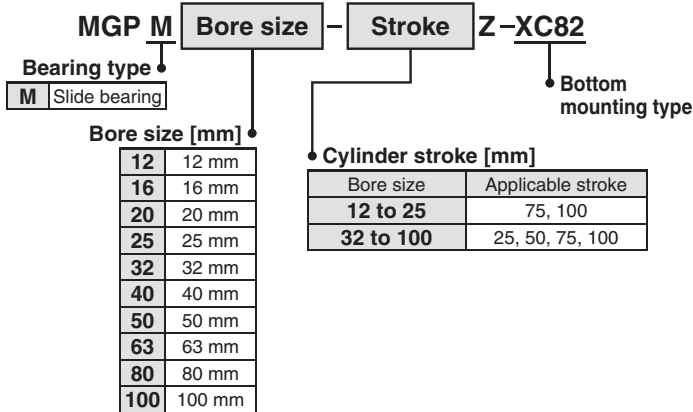

Note) The total length (ZZ) of the guide rod bushing is shorter than the standard products.

## 12 Grease for Food Processing Equipment

Symbol  
**-XC85**

Food grade grease (certified by NSF-H1) is used as lubricant.

### Applicable Series

Series	Model	Bearing type
MGP-Z	Standard type	MGPM
		MGPL
		MGPA
	With air cushion	MGPM
		MGPL
		MGPA

### Specifications

<b>Ambient temperature range</b>	0°C to 60°C
<b>Seals material</b>	Nitrile rubber
<b>Grease</b>	Grease for food
<b>Auto switch</b>	Mountable
<b>Dimensions</b>	Same as standard type
<b>Specifications other than above</b>	Same as standard type

### How to Order



### Warning

#### Precautions

Be aware that smoking cigarettes etc. after your hands have come into contact with the grease used in this cylinder can create a gas that is hazardous to humans.

#### Not installable zone

**Food zone** ..... An environment where food which will be sold as merchandise, directly touches the cylinder's components.

**Splash zone** ..... An environment where food which will not be sold as merchandise, directly touches the cylinder's components.

#### Installable zone

**Non-food zone**.... An environment where there is no contact with food.

Note 1) Avoid using this product in the food zone. (Refer to the figure on the right.)

Note 2) When the product is used in an area of liquid splash, or a water resistant function is required for the product, please consult with SMC.

Note 3) Operate without lubrication from a pneumatic system lubricator.

Note 4) Use the following grease pack for the maintenance work.

**GR-H-010** (Grease: 10 g)

Note 5) Please contact SMC for details about the maintenance intervals for this cylinder, which differ from those of the standard cylinder.

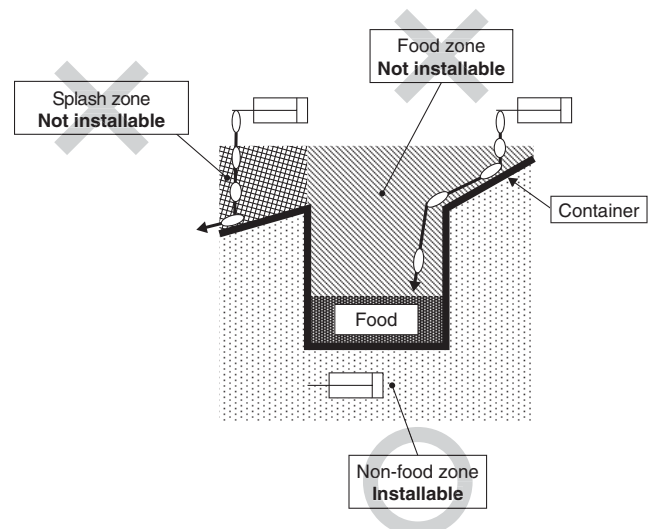

Basic Type

MGP

With Air Cushion

MGP

Auto Switch

Made to Order

# Series MGP

## 13 Symmetrical Port Position

Symbol  
**-X144**

Ports are mounted symmetrically.

### Applicable Series

Series	Model	Bearing type	
MGP-Z	Standard type	MGPM	Slide bearing
		MGPL	Ball bushing
		MGPA	High precision ball bushing

### How to Order

MGP <sup>M</sup><sub>L</sub><sub>A</sub> Standard model no. **-X144**  
Symmetrical port position

This makes it easy to remove and rotate piping when it is mounted on a wall where mounting space is limited.

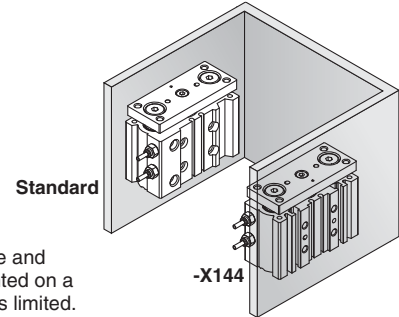

### Dimensions (Dimensions other than below are the same as standard type.)

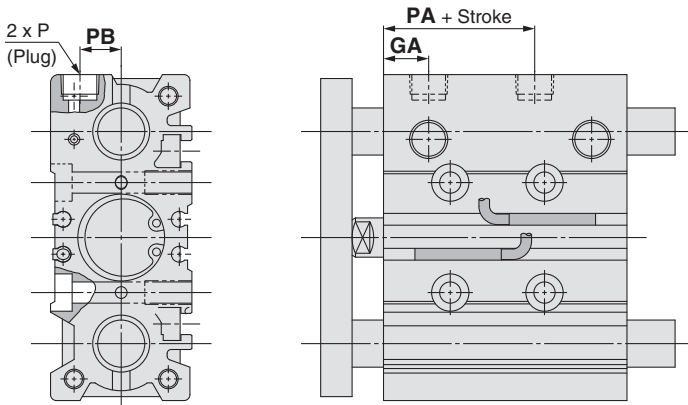

### MGPM, MGPL, MGPA Common Dimensions

Bore size (mm)	GA	PA	PB
12	10	13	8
16	10.5	14.5	10
20	11.5	13.5	10.5
25	11.5	12.5	13.5
32	12	6.5	16
40	15	13	18
50	15	9	21.5
63	15.5	13	28
80	19	14.5	25.5
100	22.5	17.5	32.5

## 14 Side Porting Type (Plug location changed)

Symbol  
**-X867**

Ports on the top plugged in order to use the piping port on the side.

### Applicable Series

Series	Model	Bearing type	
MGP-Z	Standard type	MGPM	Slide bearing
		MGPL	Ball bushing
		MGPA	High precision ball bushing
	With air cushion	MGPM	Slide bearing
		MGPL	Ball bushing
		MGPA	High precision ball bushing

### How to Order

MGP <sup>M</sup><sub>L</sub><sub>A</sub> Standard model no. **-X867**  
Side porting type (Plug location changed)

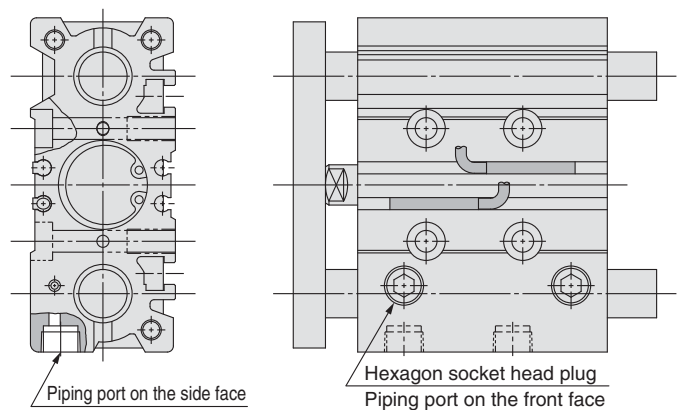









## Safety Instructions

These safety instructions are intended to prevent hazardous situations and/or equipment damage. These instructions indicate the level of potential hazard with the labels of “**Caution**,” “**Warning**” or “**Danger**.” They are all important notes for safety and must be followed in addition to International Standards (ISO/IEC)\*1), and other safety regulations.

-  **Caution:** **Caution** indicates a hazard with a low level of risk which, if not avoided, could result in minor or moderate injury.
-  **Warning:** **Warning** indicates a hazard with a medium level of risk which, if not avoided, could result in death or serious injury.
-  **Danger:** **Danger** indicates a hazard with a high level of risk which, if not avoided, will result in death or serious injury.

- \*1) ISO 4414: Pneumatic fluid power – General rules relating to systems.  
ISO 4413: Hydraulic fluid power – General rules relating to systems.  
IEC 60204-1: Safety of machinery – Electrical equipment of machines.  
(Part 1: General requirements)  
ISO 10218-1: Manipulating industrial robots - Safety.  
etc.

### Warning

- 1. The compatibility of the product is the responsibility of the person who designs the equipment or decides its specifications.**  
Since the product specified here is used under various operating conditions, its compatibility with specific equipment must be decided by the person who designs the equipment or decides its specifications based on necessary analysis and test results. The expected performance and safety assurance of the equipment will be the responsibility of the person who has determined its compatibility with the product. This person should also continuously review all specifications of the product referring to its latest catalogue information, with a view to giving due consideration to any possibility of equipment failure when configuring the equipment.
- 2. Only personnel with appropriate training should operate machinery and equipment.**  
The product specified here may become unsafe if handled incorrectly. The assembly, operation and maintenance of machines or equipment including our products must be performed by an operator who is appropriately trained and experienced.
- 3. Do not service or attempt to remove product and machinery/equipment until safety is confirmed.**
  1. The inspection and maintenance of machinery/equipment should only be performed after measures to prevent falling or runaway of the driven objects have been confirmed.
  2. When the product is to be removed, confirm that the safety measures as mentioned above are implemented and the power from any appropriate source is cut, and read and understand the specific product precautions of all relevant products carefully.
  3. Before machinery/equipment is restarted, take measures to prevent unexpected operation and malfunction.
- 4. Contact SMC beforehand and take special consideration of safety measures if the product is to be used in any of the following conditions.**
  1. Conditions and environments outside of the given specifications, or use outdoors or in a place exposed to direct sunlight.
  2. Installation on equipment in conjunction with atomic energy, railways, air navigation, space, shipping, vehicles, military, medical treatment, combustion and recreation, or equipment in contact with food and beverages, emergency stop circuits, clutch and brake circuits in press applications, safety equipment or other applications unsuitable for the standard specifications described in the product catalogue.
  3. An application which could have negative effects on people, property, or animals requiring special safety analysis.
  4. Use in an interlock circuit, which requires the provision of double interlock for possible failure by using a mechanical protective function, and periodical checks to confirm proper operation.

### Caution

- 1. The product is provided for use in manufacturing industries.**  
The product herein described is basically provided for peaceful use in manufacturing industries.  
If considering using the product in other industries, consult SMC beforehand and exchange specifications or a contract if necessary.  
If anything is unclear, contact your nearest sales branch.

## Limited warranty and Disclaimer/ Compliance Requirements

The product used is subject to the following “Limited warranty and Disclaimer” and “Compliance Requirements”.

Read and accept them before using the product.

### Limited warranty and Disclaimer

1. The warranty period of the product is 1 year in service or 1.5 years after the product is delivered.\*2)  
Also, the product may have specified durability, running distance or replacement parts. Please consult your nearest sales branch.
2. For any failure or damage reported within the warranty period which is clearly our responsibility, a replacement product or necessary parts will be provided.  
This limited warranty applies only to our product independently, and not to any other damage incurred due to the failure of the product.
3. Prior to using SMC products, please read and understand the warranty terms and disclaimers noted in the specified catalogue for the particular products.

\*2) Vacuum pads are excluded from this 1 year warranty.

A vacuum pad is a consumable part, so it is warranted for a year after it is delivered. Also, even within the warranty period, the wear of a product due to the use of the vacuum pad or failure due to the deterioration of rubber material are not covered by the limited warranty.

### Compliance Requirements

1. The use of SMC products with production equipment for the manufacture of weapons of mass destruction (WMD) or any other weapon is strictly prohibited.
2. The exports of SMC products or technology from one country to another are governed by the relevant security laws and regulations of the countries involved in the transaction. Prior to the shipment of a SMC product to another country, assure that all local rules governing that export are known and followed.

## Safety Instructions

Be sure to read “Handling Precautions for SMC Products” (M-E03-3) before using.

### SMC Corporation (Europe)

Austria	☎+43 (0)2262622800	www.smc.at	office@smc.at
Belgium	☎+32 (0)33551464	www.smc-pneumatics.be	info@smc-pneumatics.be
Bulgaria	☎+359 (0)2807670	www.smc.bg	office@smc.bg
Croatia	☎+385 (0)13707288	www.smc.hr	office@smc.hr
Czech Republic	☎+420 541424611	www.smc.cz	office@smc.cz
Denmark	☎+45 70252900	www.smc.dk.com	smc@smcdk.com
Estonia	☎+372 6510370	www.smc-pneumatics.ee	smc@smc-pneumatics.ee
Finland	☎+358 207513513	www.smc.fi	smcfin@smc.fi
France	☎+33 (0)164761000	www.smc-france.fr	promotion@smc-france.fr
Germany	☎+49 (0)61034020	www.smc-pneumatik.de	info@smc-pneumatik.de
Greece	☎+30 210 2717265	www.smchellas.gr	sales@smchellas.gr
Hungary	☎+36 23511390	www.smc.hu	office@smc.hu
Ireland	☎+353 (0)14039000	www.smc-pneumatics.ie	sales@smc-pneumatics.ie
Italy	☎+39 0292711	www.smcitalia.it	mailbox@smcitalia.it
Latvia	☎+371 67817700	www.smc.lv	info@smclv.lv

Lithuania	☎+370 5 2308118	www.smclt.lt	info@smclt.lt
Netherlands	☎+31 (0)205318888	www.smc-pneumatics.nl	info@smc-pneumatics.nl
Norway	☎+47 67129020	www.smc-norge.no	post@smc-norge.no
Poland	☎+48 (0)222119616	www.smc.pl	office@smc.pl
Portugal	☎+351 226166570	www.smc.eu	postpt@smc.smces.es
Romania	☎+40 213205111	www.smcromania.ro	smcromania@smcromania.ro
Russia	☎+7 8127185445	www.smc-pneumatik.ru	info@smc-pneumatik.ru
Slovakia	☎+421 (0)413213212	www.smc.sk	office@smc.sk
Slovenia	☎+386 (0)73885412	www.smc.si	office@smc.si
Spain	☎+34 902184100	www.smc.eu	post@smc.smces.es
Sweden	☎+46 (0)86031200	www.smc.nu	post@smc.nu
Switzerland	☎+41 (0)523963131	www.smc.ch	info@smc.ch
Turkey	☎+90 212 489 0 440	www.smc-pneumatik.com.tr	info@smc-pneumatik.com.tr
UK	☎+44 (0)845 121 5122	www.smc-pneumatics.co.uk	sales@smc-pneumatics.co.uk