

Tiny, 1.8V to 5.5V Input, 440nA IQ, 175mA nanoPower Buck Converter with Four-Level VSEL

MAX38647B

Benefits and Features

- Extends Battery Life
 - 440nA Ultra-Low Quiescent Supply Current
 - 5nA Shutdown Current
 - 94% Peak Efficiency and Over 90% at 10 μ A
- Easy to Use—Addresses Popular Operation
 - 1.8V to 5.5V Input Voltage Range
 - 0.5V to 1.8V Output Voltage Range
 - Up to 175mA Output Current
- Protects System in Multiple Use Cases
 - Short-Circuit Protection
 - Internal Active Discharge
- Programmable Single Resistor (32 Settings)
 - Four Output Voltage Levels for Each RSEL Setting Through Digitally Controlled VSEL1 and VSEL2 Pins
- EN Pin for Converter On/Off Control
- 100% Duty-Cycle Mode for Low Dropout Operation
- Reduces Size and Increases Reliability
 - -40°C to +125°C Operating Temperature Range
 - 8-Bump WLP (1.82mm x 0.89mm, 0.4mm Pitch)
 - 10-Pin TDFN (3mm x 3mm, 0.5mm Pitch)

Key Applications

- Portable Space-Constrained Consumer Products
- Wearable Devices Ultra-Low-Power IoT, NB IoT, and Bluetooth® LE
- Single Li-ion and Coin-Cell Battery Products
- Wired, Wireless Industrial Products

Simplified Application Circuit

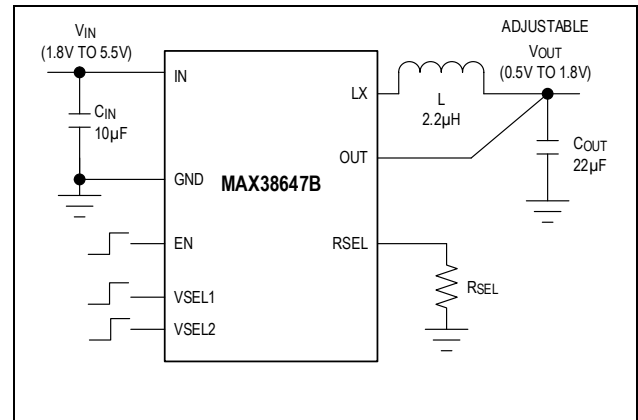

Pin Configurations

8 WLP

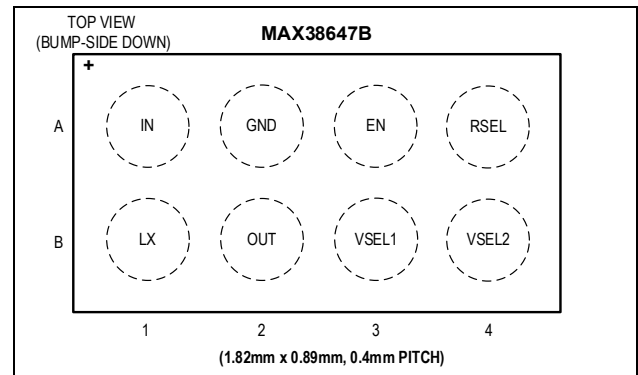

Bluetooth is a registered trademark of Bluetooth SIG, Inc.

[Ordering Information](#) appears at end of data sheet.

Absolute Maximum Ratings

VIN, VOUT, VSEL1, VSEL2, EN to GND.....	-0.3V to +6V	Continuous Power Dissipation (TDFN, TA = +70°C) (Derate 24.40mW/°C above +70°C).....	1951mW
RSEL to GND.....	-0.3V to VIN + 0.3V	Operating Temperature Range	-40°C to +125°C
LX RMS Current.....	-1.6ARMS to +1.6ARMS	Maximum Junction Temperature.....	+150°C
LX to GND (Note 1).....	-0.3V to VIN + 0.3V	Storage Temperature Range	-65°C to +150°C
Continuous Power Dissipation (WLP, TA = +70°C) (Derate 11.40mW/°C above +70°C).....	912mW	Lead Temperature (Soldering, 10 seconds).....	+300°C
		Soldering Temperature (reflow).....	+260°C

Note 1: The LX pin has internal clamps to GND and IN. These diodes may be forward biased during switching transitions. During these transitions, the max LX current should be within the maximum RMS current rating for safe operation.

Stresses beyond those listed under "Absolute Maximum Ratings" may cause permanent damage to the device. These are stress ratings only, and functional operation of the device at these or any other conditions beyond those indicated in the operational sections of the specifications is not implied. Exposure to absolute maximum rating conditions for extended periods may affect device reliability.

Package Information

8 WLP

Package Code	N80F1+1
Outline Number	21-100605
Land Pattern Number	Refer to Application Note 1891
THERMAL RESISTANCE, FOUR-LAYER BOARD:	
Junction-to-Ambient (θJA)	87.71°C/W
Junction-to-Case Thermal Resistance (θJC)	N/A

10 TDFN

Package Code	T1033+1C
Outline Number	21-0137
Land Pattern Number	90-0003
THERMAL RESISTANCE, FOUR-LAYER BOARD:	
Junction-to-Ambient (θJA)	41°C/W
Junction-to-Case Thermal Resistance (θJC)	9°C/W

For the latest package outline information and land patterns (footprints), go to www.maximintegrated.com/packages. Note that a "+", "#", or "-" in the package code indicates RoHS status only. Package drawings may show a different suffix character, but the drawing pertains to the package regardless of RoHS status.

Package thermal resistances were obtained using the method described in JEDEC specification JESD51-7, using a four-layer board. For detailed information on package thermal considerations, refer to www.maximintegrated.com/thermaltutorial.

Electrical Characteristics

(V_{IN} = 3.3V, V_{EN} = 3.3V, V_{OUT} = 1.8V, T_A = -40°C to +125°C, L = 2.2μH, C_{OUT} = 22μF, unless otherwise specified. ([Note 2](#)))

PARAMETER	SYMBOL	CONDITIONS		MIN	TYP	MAX	UNITS
Input Voltage Range	V _{IN}	Guaranteed by output accuracy		1.8		5.5	V
Input Voltage UVLO	V _{UVLO}	V _{IN} rising			1.75	1.8	V
		V _{IN} falling			1.7		
Input Shutdown Current	I _{SD_IN}	V _{EN} = 0V, T _A = +25°C			0.005	0.1	μA
Quiescent Supply Current Into IN	I _{Q_IN}	V _{EN} = V _{IN} , not switching, V _{OUT} = 104% of target voltage, T _A = +25°C			440	750	nA
Quiescent Supply Current Into OUT	I _{Q_OUT}	V _{EN} = V _{IN} , not switching, V _{OUT} = 104% of target voltage, T _A = +25°C			17		nA
Output Voltage Range	V _{OUT}	Guaranteed by output accuracy		0.5		1.8	V
Output Accuracy	ACC	V _{OUT} falling when LX begins switching above 300kHz, V _{IN} > V _{OUT} + 0.3V, (Note 3)	V _{OUT} = 0.5V to 1.8V	-1.5		+1.5	%
Low-Power Mode Over-Regulation Hysteresis	LPM_HYS	Hysteresis measured as percent of target output voltage (Note 4)		+1.3	+2.7	+4	%
DC Load Regulation	ACCLD_REG	I _{LOAD} from 1mA to 80% of I _{PEAK_LX}			±2.5		%
Soft-Start Time	t _{SS}	V _{OUT} = 1.8V, I _{OUT} = 0mA			1		ms
Select-Resistor Detection Time	t _{RSL}	C _{SEL} < 2pF		240	600	1320	μs
Required R _{SEL} Resistor Accuracy	ACC _{RSEL}	Use nearest ±1% resistor from Table 1		-1		+1	%
Active Discharge Resistor	R _{OUT_DIS}	V _{EN} = 0V		50	85	200	Ω
High-Side MOSFET Channel On Resistance	R _{DS_H}	V _{IN} = 3.3V			320	600	mΩ
Low-Side MOSFET Channel On Resistance	R _{DS_L}	V _{IN} = 3.3V			150	290	mΩ
LX Leakage Current	I _{LEAK_LX}	V _{LX} = V _{OUT} = 5.5V, V _{EN} = 0V, T _A = +25°C			10	100	nA
Inductor Peak Current Limit	I _{PEAK_LX}	(Note 5)		0.2	0.25	0.3	A
Zero-Crossing Threshold	I _{ZX_LX}	V _{OUT} = 1.2V			12.5		mA
EN Input Leakage Current	I _{LEAK_EN}	V _{EN} = 5.5V, T _A = +25°C			1	100	nA
EN Voltage Threshold	V _{IH_EN}	V _{EN} rising			0.85	1.2	V
	V _{IL_EN}	V _{EN} falling		0.4	0.725		
VSEL Input Leakage Current	I _{LEAK_VSEL}	V _{VSEL1} , V _{VSEL2} = 5.5V, T _A = +25°C			1	100	nA
VSEL Voltage Threshold	V _{IH_VSEL}	V _{VSEL1} , V _{VSEL2} rising			0.75	1.2	V
	V _{IL_VSEL}	V _{VSEL1} , V _{VSEL2} falling		0.4	0.625		

($V_{IN} = 3.3V$, $V_{EN} = 3.3V$, $V_{OUT} = 1.8V$, $T_A = -40^{\circ}C$ to $+125^{\circ}C$, $L = 2.2\mu H$, $C_{OUT} = 22\mu F$, unless otherwise specified. (Note 2))

PARAMETER	SYMBOL	CONDITIONS	MIN	TYP	MAX	UNITS
VSEL State Blanking Time	tVSEL_HOLD	VVSEL1, VVSEL2 high or low state	1	2	6	μs
Thermal-Shutdown Threshold	T_SHUT	T _J rising when output turns off		165		$^{\circ}C$
		T _J falling when output turns on		150		

- Note 2:** Limits over the specified operating temperature and supply voltage range are guaranteed by design and characterization, and production tested at room temperature only.
- Note 3:** Output accuracy in low-power mode (LPM) does not include load, line, or ripple.
- Note 4:** This LPM_HYS percentage is only for 1.8V output voltage. For other output voltages, a typical value of 45mV can be considered as LPM_HYS at +25°C.
- Note 5:** This is a static measurement. The actual peak current limit depends upon V_{IN} , V_{OUT} , and the inductor due to propagation delays.

Typical Operating Characteristics

(MAX38647BANA+, $V_{IN} = 3.6V$, $V_{OUT} = 1.8V$, $L = 2.2\mu H$, $C_{IN} = 10\mu F$, $C_{OUT} = 22\mu F$, $T_A = +25^{\circ}C$, unless otherwise noted.)

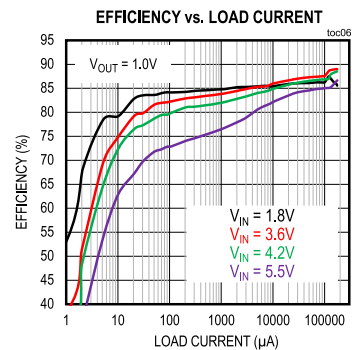
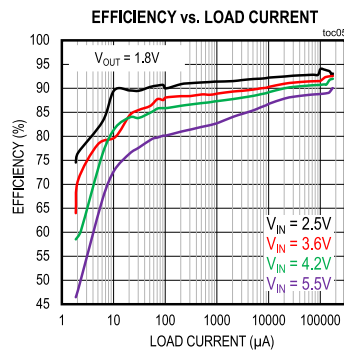
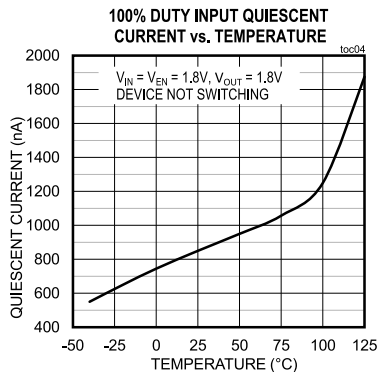
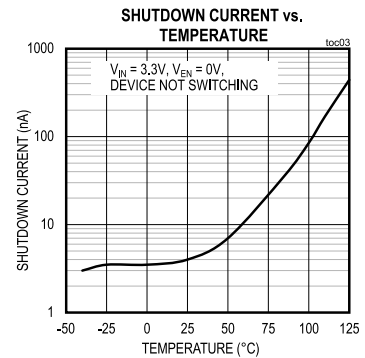
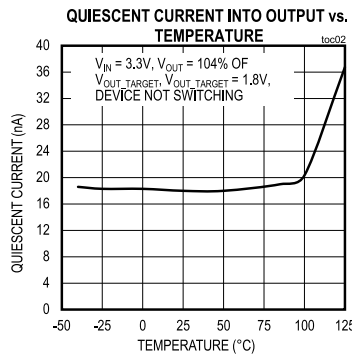
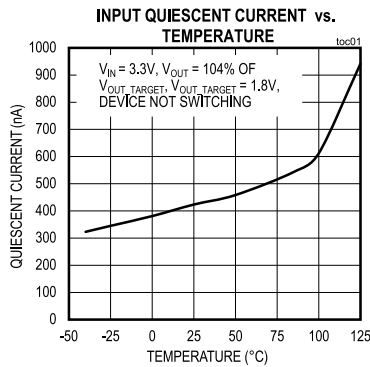

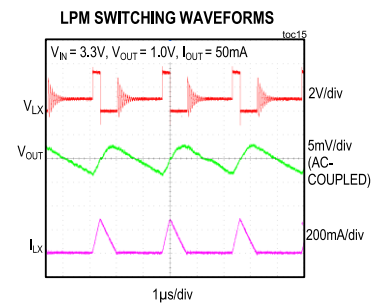
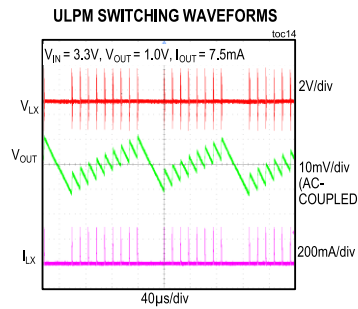
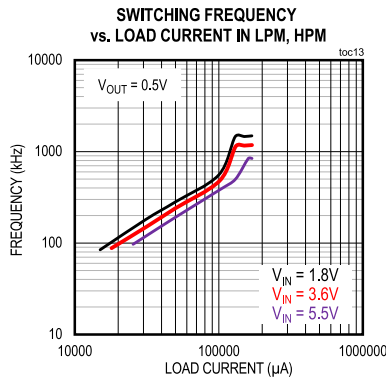
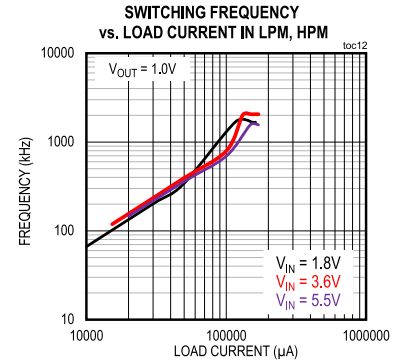
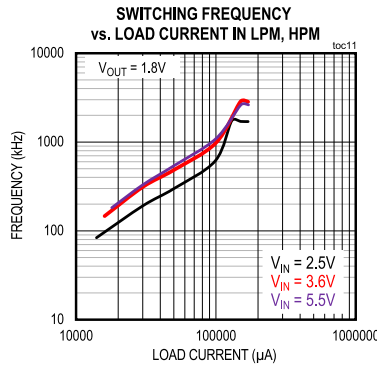
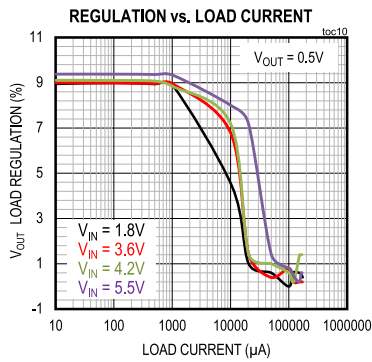
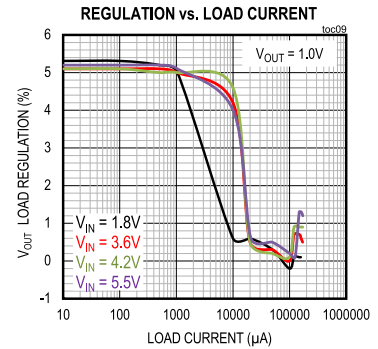
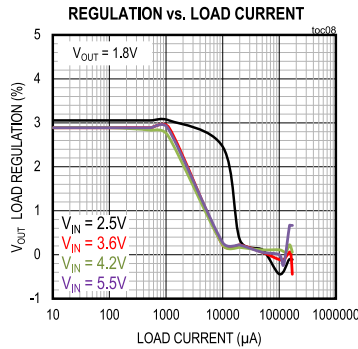
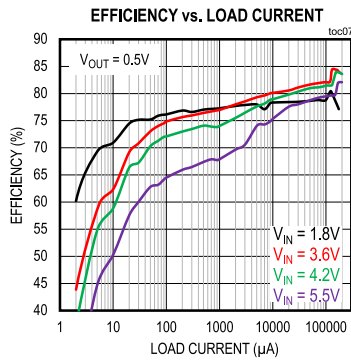

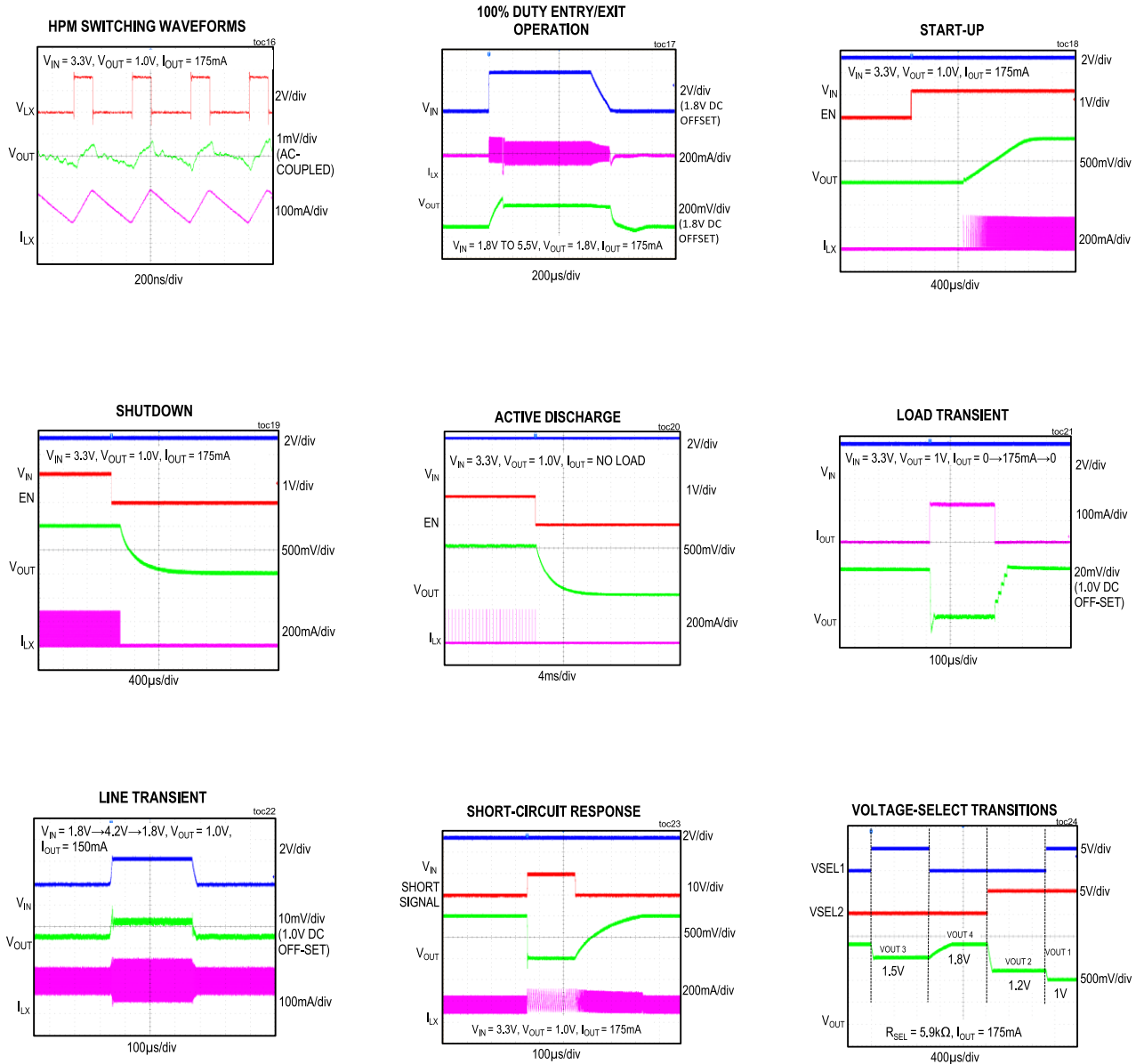

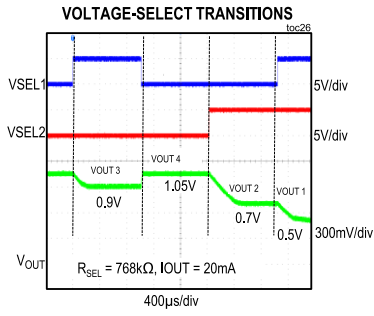
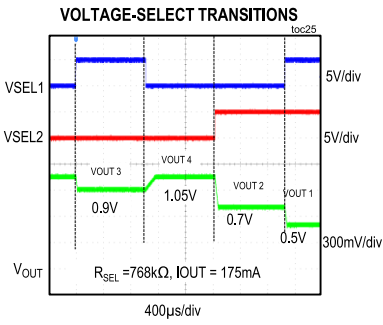

Pin Configurations (continued)

8 WLP

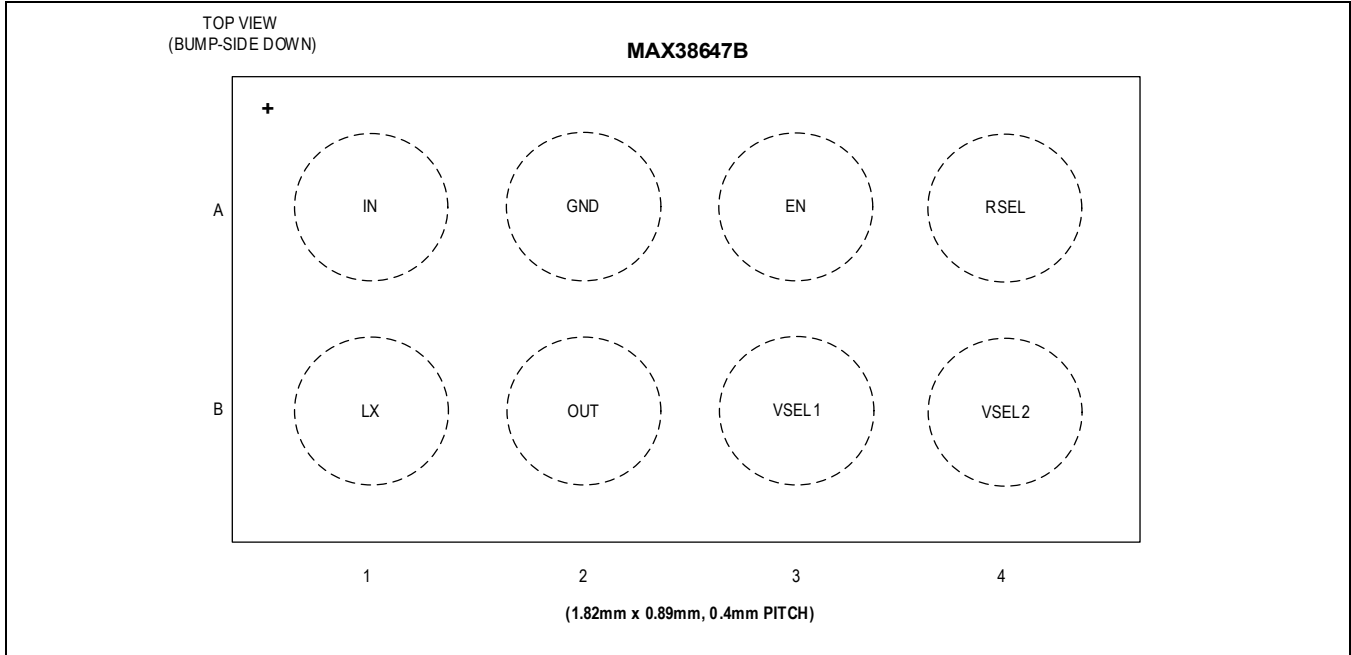

10 TDFN

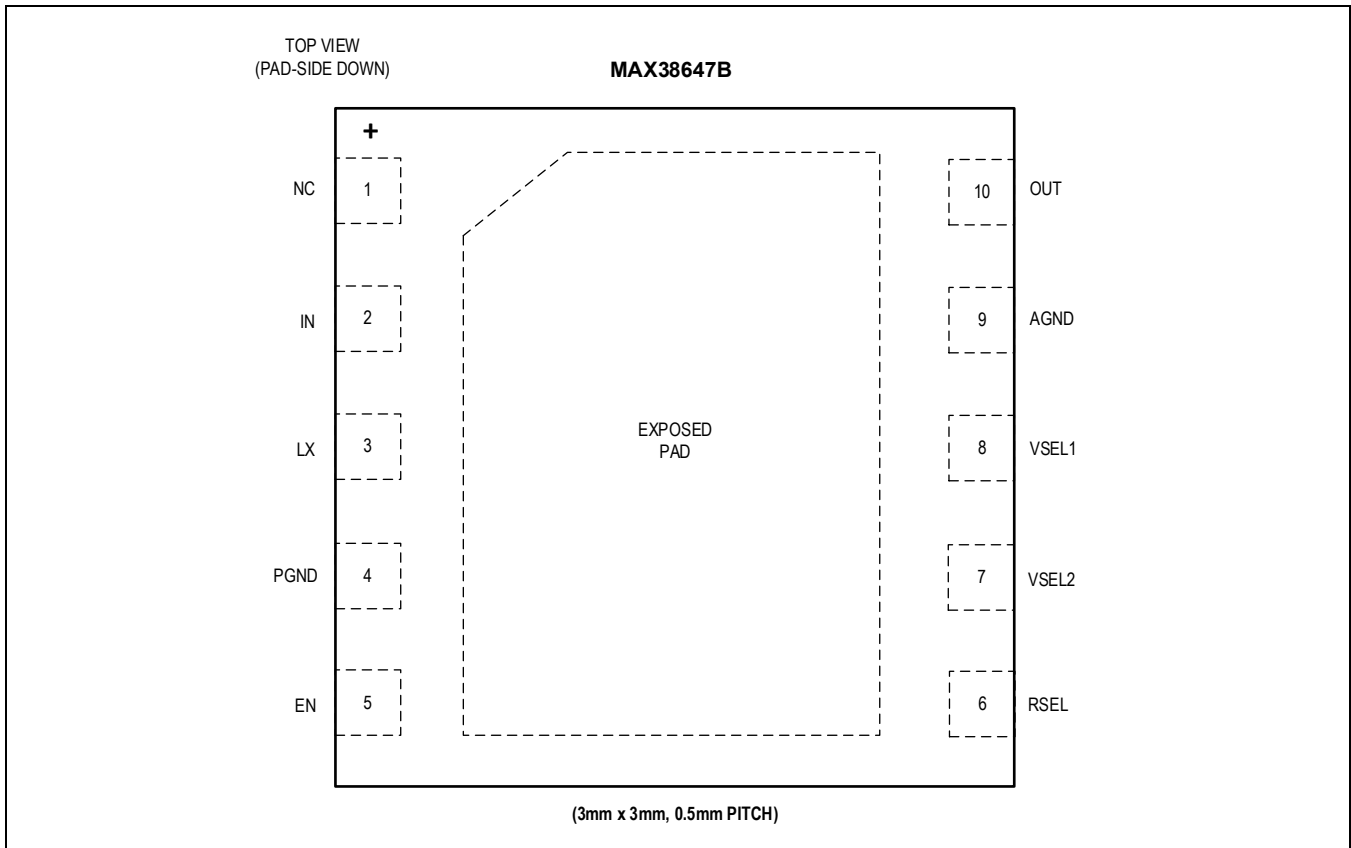

Pin Descriptions

PIN		NAME	FUNCTION
MAX38647B ANA+	MAX38647B ATB+		
–	1	NC	Not Connected. This pin is internally not connected. It can be left floating.
A1	2	IN	Power Supply Input. Input supply range is from 1.8V to 5.5V. Bypass IN to GND with a minimum 10 μ F ceramic capacitor as close as possible to the device.
B1	3	LX	Switching Node. Connect an inductor between LX and the regulator output.
–	4	PGND	Power Ground. Connect PGND to the power ground plane. Connect all the circuit ground connections together at a single point.
A2	–	GND	Ground. Connect GND to the power ground plane. Connect all the circuit ground connections together at a single point.
A3	5	EN	Enable Input. Force this pin high to enable the buck converter. Force this pin low to disable the part and enter shutdown. Active discharge is enabled when EN is pulled low.
A4	6	RSEL	Output Voltage Select Input. Connect a resistor from RSEL to GND/AGND to program target output voltages.
B3	8	VSEL1	Output Voltage Level Selection Input 1. The logic combinations shown in Table 2 are used for selection of dynamic voltage levels.
B4	7	VSEL2	Output Voltage Level Selection Input 2. The logic combinations shown in Table 2 are used for selection of dynamic voltage levels.
–	9	AGND	Analog Ground
B2	10	OUT	Output Voltage Sense Input. Connect to the load at a point where accurate regulation (output capacitor) is required to eliminate resistive metal drops.

Functional Diagram

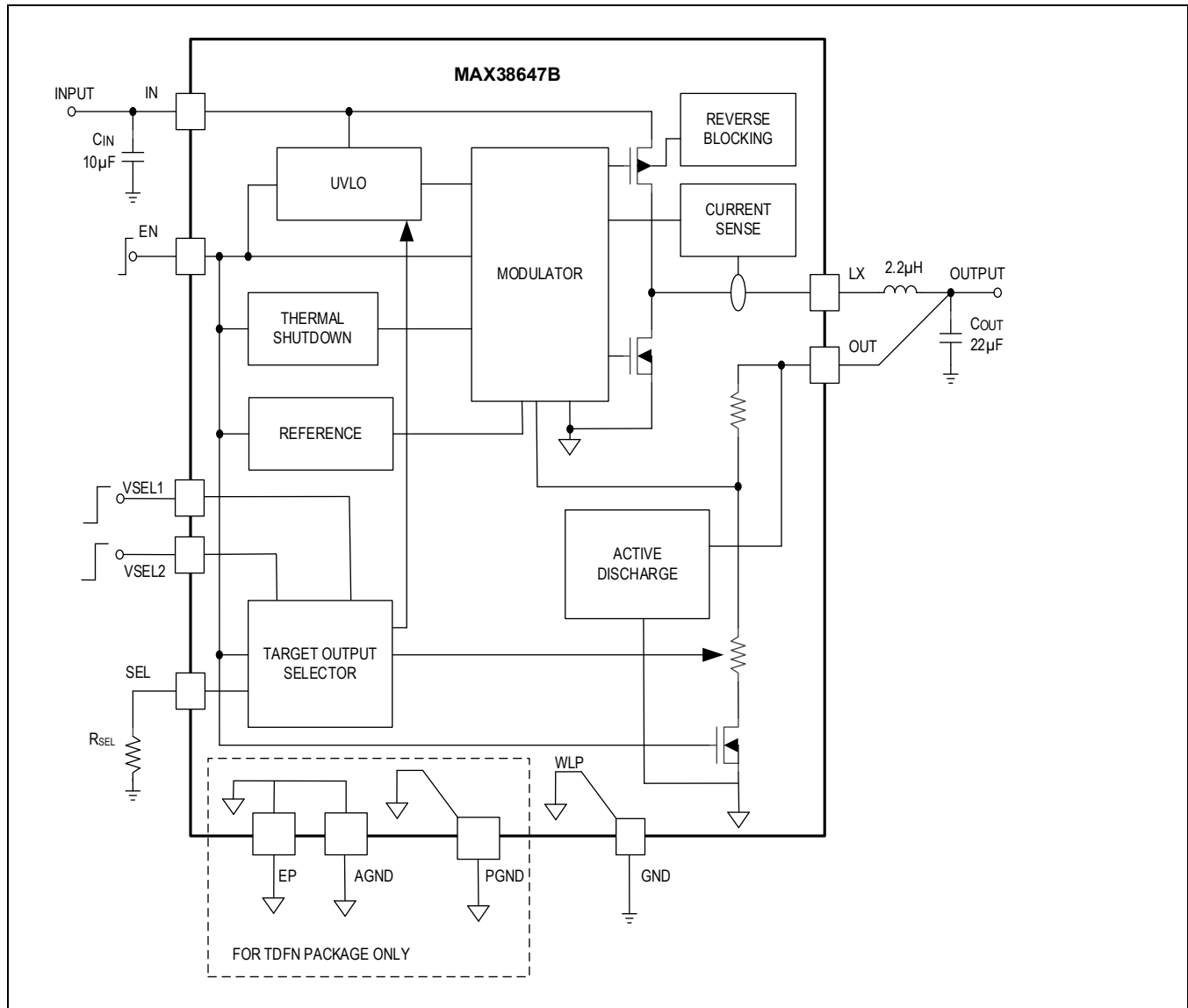

Detailed Description

The MAX38647B is an ultra-low I_Q (440nA) buck converter that steps-down an input voltage range of 1.8V to 5.5V to a wide range of output voltages from 0.5V to 1.8V. Through a single external resistor (R_{SEL}) on the RSEL pin, it is possible to program four different output voltages as given in [Table 1](#). The output voltage can be changed dynamically between the selected four output voltages using two voltage select pins VSEL1 and VSEL2 by pulling them high or low. The four output voltages are determined during start-up. The output voltage transition from low voltage to high voltage is open-loop current-limit controlled. The voltage transition from high voltage to low voltage is purely dependent on the load.

The buck converter automatically switches between ultra-low-power mode (ULPM), low-power mode (LPM) and high-power mode (HPM) to service the load at the highest possible efficiency depending on the load current. The buck converter overregulates in ULPM to allow the output capacitor to prevent output undershoot during load transients. See [Figure 1](#) for the MAX38647B mode transitions. The device supports 100% duty-cycle operation.

The active discharge resistor pulls OUT to ground when the part is in shutdown. In applications where the ambient temperature is more than +85°C, a load current of >10µA may be required to prevent the output from soaring due to power FET leakage.

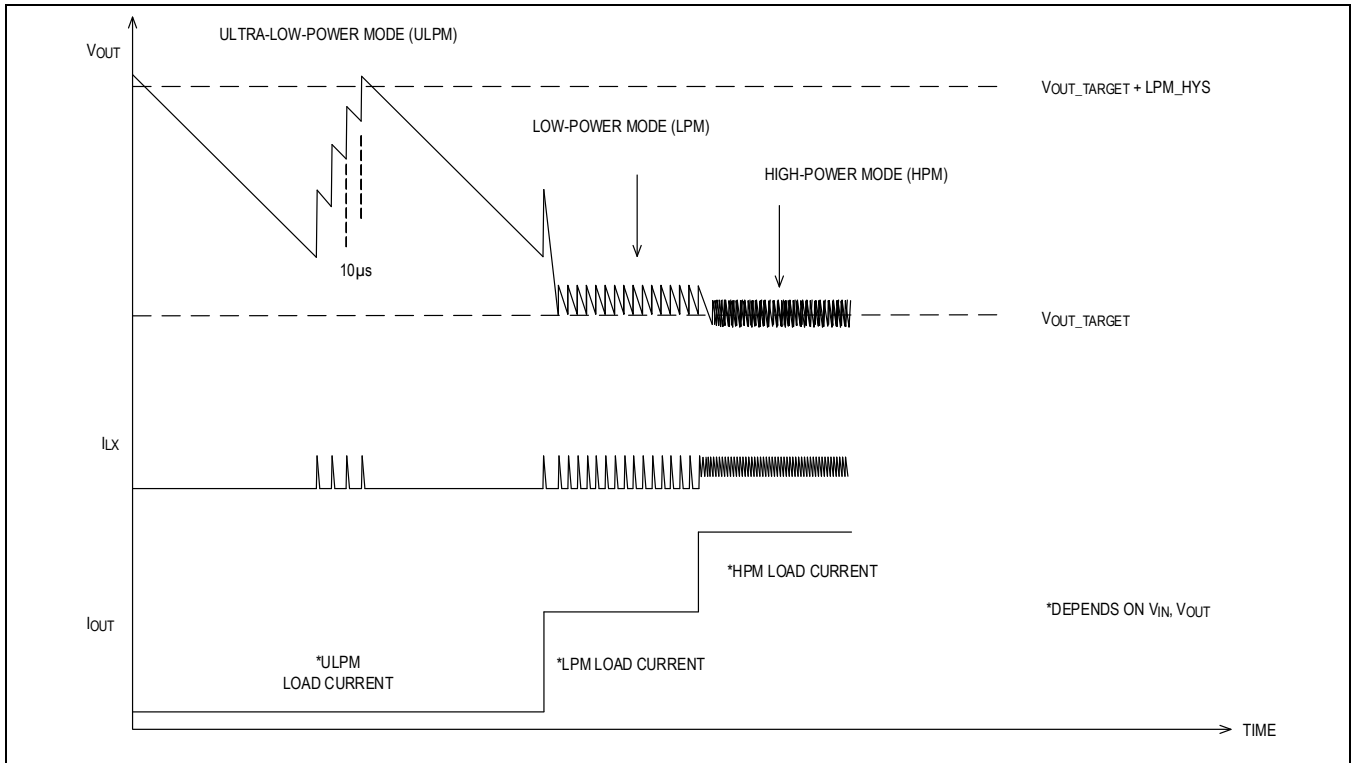

Figure 1. MAX38647B Mode Transitions

Enabling the Device

When V_{IN} is above the UVLO rising threshold and the EN pin is pulled high (V_{EN} > V_{IH_EN}), the part is enabled. There is a delay in reading the RSEL pin after which the soft-start circuit ramps the output voltage. When the EN pin is pulled low (V_{EN} < V_{IL_EN}), the MAX38647B shuts down. While in shutdown, 5nA (typ) of current is consumed from IN.

Start-Up

The MAX38647B has a built-in soft-start to avoid inrush current. It follows the sequence in [Figure 2](#).

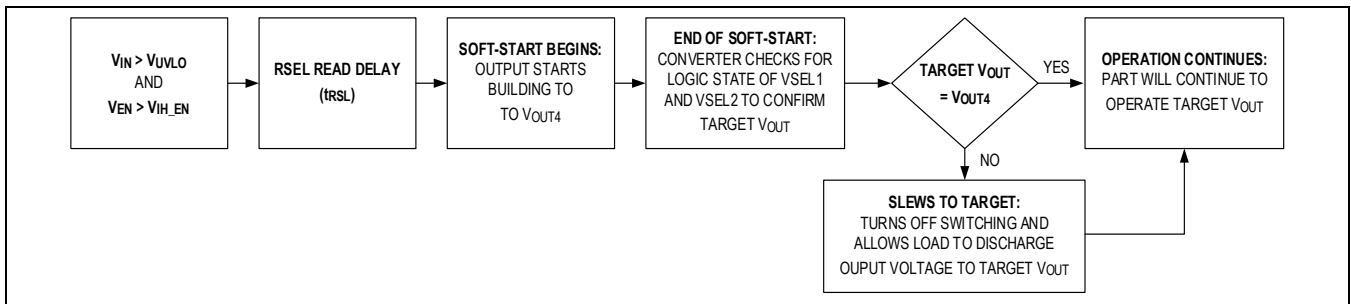

Figure 2. MAX38647B Start-Up Sequence

Voltage Configuration

The MAX38647B includes an RSEL pin to configure the output voltages. For a given RSEL resistor, four output voltages are possible. The user needs to select the appropriate RSEL resistor value meeting their requirements from [Table 1](#). Out of these four possible voltages, the steady-state target output is decided by the logic state of the VSEL pins given in [Table 2](#). RSEL resistor with a tolerance of 1% (or better) should be chosen.

At start-up, the MAX38647B takes typically 600 μ s (tRSL) to read the RSEL value. Care must be taken that the total capacitance on this pin is less than 2pF. See the [PCB Layout Guidelines](#) for more information.

The RSEL output voltage selection method has many benefits:

- In conventional converters, current is drawn from the output continuously through a feedback resistor-divider. In the MAX38647B, 200 μ A of current is drawn only during startup, which helps to increase efficiency at light loads.
- The MAX38647B provides lower cost and smaller size, since only one resistor is needed versus two resistors in typical feedback connections. Moreover, only one resistor is needed to select all four voltages which are required for dynamic voltage change.
- The RSEL feature allows customers to stock just one part in their inventory system and use it in multiple projects with multiple combination of four different output voltages just by changing a single standard 1% resistor.
- The RSEL feature allows much higher internal feedback resistors instead of lower impedance external feedback resistors, thus enabling ultra-low-power applications.

Table 1. MAX38647B RSEL Selection Table

RSEL (k Ω)	TARGET OUTPUT VOLTAGES (V)			
	V _{OUT1}	V _{OUT2}	V _{OUT3}	V _{OUT4}
OPEN	0.5	0.6	0.8	0.9
900	0.5	0.7	0.8	1.0
768	0.5	0.7	0.9	1.05
634	0.55	0.65	0.8	0.9
536	0.55	0.7	0.9	1.0
452	0.6	0.7	0.8	0.9
383	0.6	0.75	0.9	1.05
324	0.6	0.8	0.95	1.1
267	0.6	0.8	1.0	1.2
226	0.65	0.8	0.9	1.05
191	0.65	0.8	1.0	1.2
162	0.7	0.75	0.8	0.9
133	0.7	0.8	0.9	1.0
113	0.7	0.8	0.95	1.1
95.3	0.7	0.85	0.9	1.2
80.6	0.75	0.8	0.9	1.0
66.5	0.75	0.85	1.0	1.2
56.2	0.8	0.85	0.9	1.0
47.5	0.8	0.9	1.05	1.2
40.2	0.8	1.0	1.2	1.5
34	0.8	1.2	1.5	1.8
28	0.85	1.0	1.1	1.2

23.7	0.85	1.05	1.2	1.5
20	0.9	1.0	1.1	1.2
16.9	0.9	1.0	1.2	1.5
14	0.9	1.2	1.5	1.8
11.8	0.95	1.0	1.1	1.2
10	0.95	1.1	1.2	1.5
8.45	1.0	1.1	1.2	1.5
7.15	1.0	1.2	1.4	1.5
5.9	1.0	1.2	1.5	1.8
4.99	1.05	1.2	1.4	1.5

Short-Circuit Protection

The MAX38647B has inbuilt protection against output short circuit by limiting the peak inductor current to avoid device damage. Once the fault (short circuit) is removed, the output recovers to the target output decided by the R_{SEL} resistor and the logic state of the VSEL1 and VSEL2 pins. The input voltage does not need to be recycled for the output to recover after removal of the fault (short circuit) condition.

100% Duty-Cycle Operation

The MAX38647B features 100% duty-cycle operation. When the input voltage approaches the output voltage, the MAX38647B stops switching and enters 100% duty-cycle operation. In this mode, the part connects the output to input through the high-side power switch and the inductor. When the input voltage is increased again where it pulls V_{OUT} to 5% above its target level, the converter exits 100% mode. At no load, the device consumes only 850nA (typ) of current in 100% duty-cycle mode while still protecting the inductor current from exceeding current limit.

Active Discharge

The MAX38647B integrates a discharge resistor from the OUT pin to GND. This discharge resistor gets activated when the converter is disabled, which helps discharge the output capacitor quickly. The typical value of the discharge resistance is 85 Ω .

Dynamic Voltage Transition Using VSEL Pins

The MAX38647B has the ability to change voltage dynamically using two voltage-select pins. Based on the logic states of the voltage-select pins, one out of four possible output voltages can be selected. The states of the VSEL1 and VSEL2 pins and the corresponding output voltages, V_{OUT1} to V_{OUT4} , are given in [Table 2](#). The typical operating waveforms of the dynamic voltage transitions for a given R_{SEL} are shown in [Figure 3](#).

Table 2. Output Voltage Selection Based on VSEL1 and VSEL2 Logic State

VSEL1	VSEL2	OUTPUT VOLTAGES
Low	Low	V_{OUT4} of Table 1
High	Low	V_{OUT3} of Table 1
Low	High	V_{OUT2} of Table 1
High	High	V_{OUT1} of Table 1

Applications Information

Typical Application Circuit

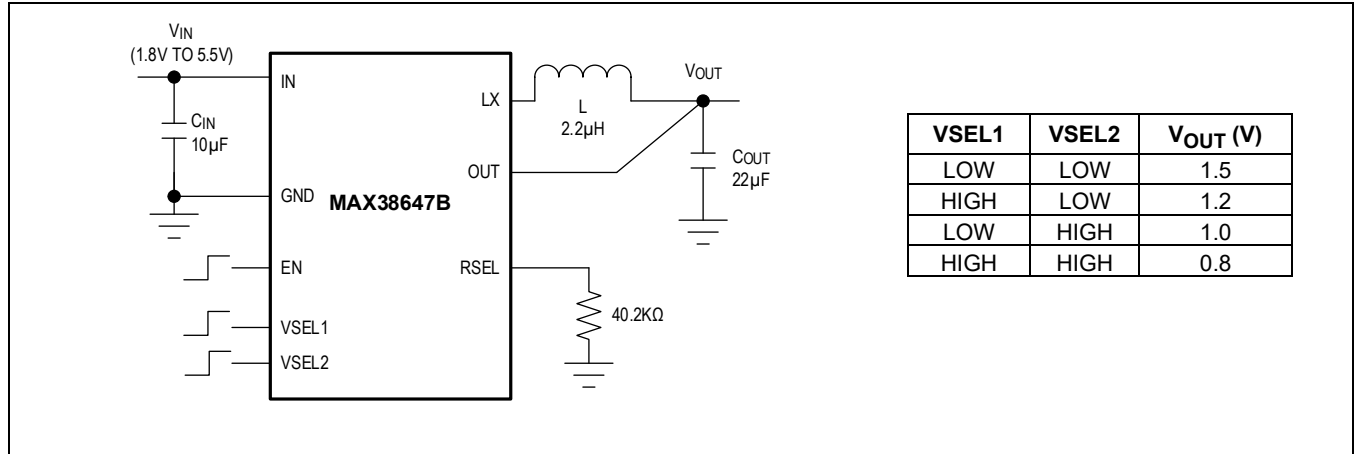

Figure 3. MAX38647B Buck Converter Using Four Dynamic Voltages

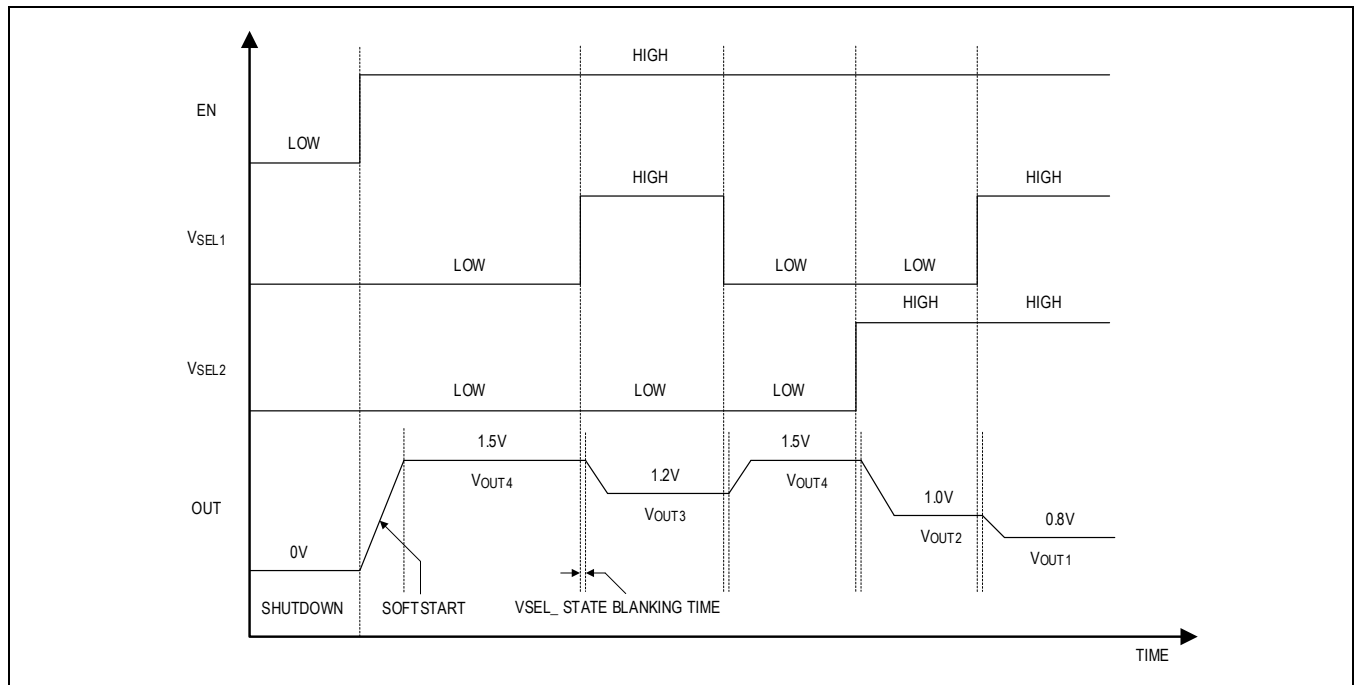

Figure 4. MAX38647B Application Waveform with Output Voltage Transitions (R_{SEL} = 40.2kΩ)

Inductor Selection

The inductor value (L) for the MAX38647B affects the ripple current, the transition point from ULPM to LPM, and overall efficiency performance. It is recommended to use an inductor value of 2.2µH. The saturation current rating of the inductor must be high enough to ensure that saturation can occur only above the peak current limit I_{PEAK_LX} (250mA typ).

Input-Capacitor Selection

The input capacitor (C_{IN}) reduces the peak current drawn from battery or input power source and reduces the switching noise in the IC. The impedance of C_{IN} at the switching frequency should be very low. Ceramic capacitors are

recommended with their small size and low equivalent series resistance (ESR). For most applications, a 10 μ F ceramic capacitor with X7R temperature characteristics is recommended. For operations where ambient temperature is less than +85°C, an X5R ceramic capacitor can be used.

Output-Capacitor Selection

The output capacitor (C_{OUT}) is required to keep the output voltage ripple small and to ensure loop stability. C_{OUT} must have low impedance at the switching frequency. Ceramic capacitors are recommended due to their small size and low equivalent series resistance (ESR). Make sure the capacitor does not degrade its capacitance significantly over temperature and DC bias. For most applications, a 22 μ F ceramic capacitor with X7R temperature characteristics is recommended. For operations where ambient is less than +85°C, an X5R ceramic capacitor can be used. For high-duty applications (duty \geq 0.9), it is recommended that the output capacitance is increased to 2 x 22 μ F.

PCB Layout Guidelines

Careful PCB layout is especially important in nanoPower DC-DC converters. Poor layout can affect the IC performance causing electromagnetic interference (EMI), electromagnetic compatibility (EMC) issues, ground bounce, voltage drops, etc. Poor layout can also affect regulation and stability.

A good layout is implemented using the following rules:

- Place the inductor, input capacitor, and output capacitor close to the IC using short traces and/or copper pours. These components carry high switching currents and long traces that act like antennas. The input capacitor placement is the most important element in the PCB layout and should be placed directly next to the IC. The inductor and output capacitor placement are secondary to the input capacitor's placement but should remain close to the IC.
- The connection from the bottom plate of the input capacitor, the output capacitor, and the ground pin of the device must be extremely short.
- Similarly, the top plate of input capacitor connection to the IN pin of the device must also be short.
- Minimize the surface area used for LX since this is the switching node.
- Keep VSEL1 and VSEL2 traces away from the LX node if these pins are driven externally.
- Keep the main power path from IN, LX, OUT, and GND as tight and short as possible.
- Maximize the size of the ground metal on the component side to help with thermal dissipation. Use a ground plane with several vias connecting to the component-side ground to further reduce noise interference on sensitive circuit nodes.
- The trace used for the RSEL signal should neither be too long nor should it produce a capacitance of more than 2pF.

It is also recommended to refer to the *MAX38647B EV kit* layout.

Ordering Information

PART NUMBER	OUTPUT VOLTAGE RANGE (V)	PIN-PACKAGE	FEATURES
MAX38647BANA+T	0.5–1.8	8-Bump WLP	175mA Output Current, ULPM, LPM, HPM Operation
MAX38647BATB+T*	0.5–1.8	10-Pin TDFN-EP**	175mA Output Current, ULPM, LPM, HPM Operation

+Denotes lead(Pb)-free/RoHS-compliant package.

T = Tape-and-reel.

*Future part—contact factory for availability.

**EP = Exposed pad.

Revision History

REVISION NUMBER	REVISION DATE	DESCRIPTION	PAGES CHANGED
0	1/23	Initial release	—



Mouser Electronics

Authorized Distributor

Click to View Pricing, Inventory, Delivery & Lifecycle Information:

[Analog Devices Inc.:](#)

[MAX38647BANA+](#) [MAX38647BANA+T](#)