

FEATURES

Ultralow distortion

SFDR

- 101 dBc at 5 MHz
- 90 dBc at 20 MHz
- 63 dBc at 70 MHz

Third-order intercept

- 43 dBm at 10 MHz

Low noise

- 3 nV/ $\sqrt{\text{Hz}}$
- 3 pA/ $\sqrt{\text{Hz}}$

High speed

- 1 GHz, -3 dB bandwidth (G = +1)
- 1350 V/ μs slew rate
- 7.5 ns settling time to 0.1%

Standard and low distortion pinout

Supply current: 15 mA

Offset voltage: 1.0 mV max

Wide supply voltage range: 3.3 V to 12 V

APPLICATIONS

Instrumentation

IF and baseband amplifiers

Active filters

ADC drivers

DAC buffers

GENERAL DESCRIPTION

The **AD8045** is a unity-gain stable voltage feedback amplifier with ultralow distortion, low noise, and high slew rate. With a spurious-free dynamic range of -90 dBc at 20 MHz, the **AD8045** is an ideal solution in a variety of applications, including ultrasound, automated test equipment (ATE), active filters, and analog-to-digital converter (ADC) drivers. The Analog Devices, Inc., proprietary next generation XFCB process and innovative architecture enable such high performance amplifiers.

The **AD8045** features a low distortion pinout for the LFCSP, which improves second harmonic distortion and simplifies the layout of the circuit board.

The **AD8045** has a 1 GHz bandwidth, a 1350 V/ μs slew rate, and settles to 0.1% in 7.5 ns. With a wide supply voltage range (3.3 V to 12 V) and a low offset voltage (200 μV), the **AD8045** is an ideal candidate for systems that require high dynamic range, precision, and high speed.

The **AD8045** amplifier is available in a 3 mm \times 3 mm LFCSP and the standard 8-lead SOIC. Both packages feature an exposed

CONNECTION DIAGRAMS

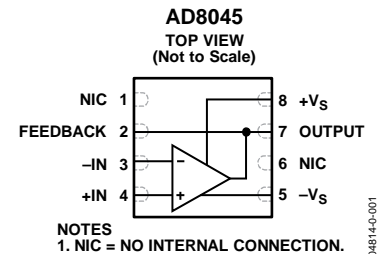

Figure 1. 8-Lead **AD8045** LFCSP (CP-8)

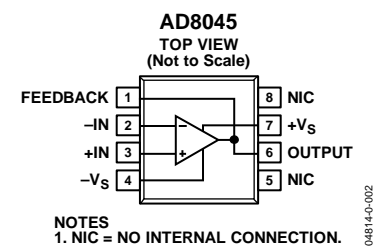

Figure 2. 8-Lead **AD8045** SOIC/EP (RD-8)

paddle that provides a low thermal resistance path to the printed circuit board (PCB). This enables more efficient heat transfer and increases reliability. The **AD8045** works over the extended industrial temperature range (-40°C to +125°C).

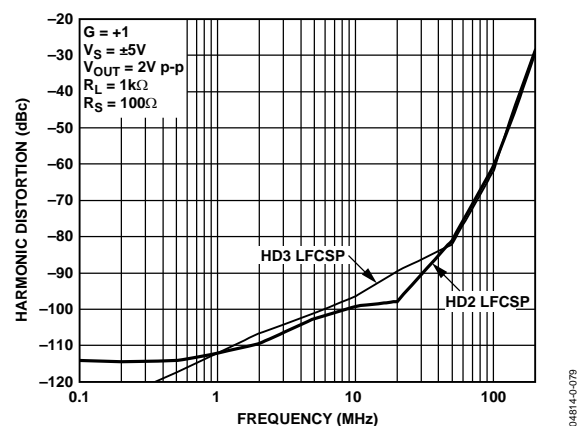

Figure 3. Harmonic Distortion vs. Frequency for Various Packages

Rev. C

Document Feedback

Information furnished by Analog Devices is believed to be accurate and reliable. However, no responsibility is assumed by Analog Devices for its use, nor for any infringements of patents or other rights of third parties that may result from its use. Specifications subject to change without notice. No license is granted by implication or otherwise under any patent or patent rights of Analog Devices. Trademarks and registered trademarks are the property of their respective owners.

TABLE OF CONTENTS

Features	1	Frequency Response	17
Applications.....	1	DC Errors	17
Connection Diagrams.....	1	Output Noise.....	18
General Description	1	Applications Information	19
Revision History	2	Low Distortion Pinout.....	19
Specifications with ± 5 V Supply	3	High Speed ADC Driver	19
Specifications with +5 V Supply	4	90 MHz Active Low-Pass Filter (LPF).....	20
Absolute Maximum Ratings.....	5	Printed Circuit Board Layout	22
Thermal Resistance	5	Signal Routing.....	22
ESD Caution.....	5	Power Supply Bypassing.....	22
Pin Configurations and Function Descriptions	6	Grounding.....	22
Typical Performance Characteristics	7	Exposed Paddle.....	23
Circuit Configurations.....	16	Driving Capacitive Loads.....	23
Wideband Operation	16	Outline Dimensions	24
Theory of Operation	17	Ordering Guide	24

REVISION HISTORY

12/2018—Rev. B to Rev. C

Changes to Table 2.....	4
Changes to Ordering Guide	24

5/2016—Rev. A to Rev. B

Changed CP-8-2 to CP-8-13	Throughout
Changes to Figure 1 and Figure 2.....	1
Changes to Figure 5, Figure 6, and Table 5	6
Deleted Table 6; Renumbered Sequentially.....	6
Updated Outline Dimensions	24
Changes to Ordering Guide	24

9/2004—Rev. 0 to Rev. A

Changes to Features Section.....	1
Changes to Specifications Section	4
Changes to Figure 58.....	15
Changes to Figure 63.....	17
Changes to Frequency Response Section	17
Changes to Figure 64.....	17
Changes to DC Errors Section.....	17
Changes to Figure 65.....	17
Changes to Figure 66.....	18
Changes to Output Noise Section	18
Changes to Ordering Guide	24

7/2004—Revision 0: Initial Version

SPECIFICATIONS WITH ± 5 V SUPPLY

$T_A = 25^\circ\text{C}$, $G = +1$, $R_S = 100\ \Omega$, $R_L = 1\ \text{k}\Omega$ to ground, unless noted otherwise. The exposed paddle must be left floating or connected to $-V_S$.

Table 1.

Parameter	Test Conditions/Comments	Min	Typ	Max	Unit
DYNAMIC PERFORMANCE					
-3 dB Bandwidth	$G = +1$, $V_{OUT} = 0.2\ \text{V p-p}$		1000		MHz
	$G = +1$, $V_{OUT} = 2\ \text{V p-p}$	300	350		
	$G = +2$, $V_{OUT} = 0.2\ \text{V p-p}$	320	400		MHz
Bandwidth for 0.1 dB Flatness	$G = +2$, $V_{OUT} = 2\ \text{V p-p}$, $R_L = 150\ \Omega$		55		MHz
Slew Rate	$G = +1$, $V_{OUT} = 4\ \text{V step}$	1000	1350		V/ μs
Settling Time to 0.1%	$G = +2$, $V_{OUT} = 2\ \text{V step}$		7.5		ns
NOISE/HARMONIC PERFORMANCE					
Harmonic Distortion (dBc) HD2/HD3	$f_C = 5\ \text{MHz}$, $V_{OUT} = 2\ \text{V p-p}$				
	LFCSP		-102/-101		dBc
	SOIC		-106/-101		dBc
	$f_C = 20\ \text{MHz}$, $V_{OUT} = 2\ \text{V p-p}$				
	LFCSP		-98/-90		dBc
	SOIC		-97/-90		dBc
	$f_C = 70\ \text{MHz}$, $V_{OUT} = 2\ \text{V p-p}$				
	LFCSP		-71/-71		dBc
	SOIC		-60/-71		dBc
Input Voltage Noise	$f = 100\ \text{kHz}$		3		nV/ $\sqrt{\text{Hz}}$
Input Current Noise	$f = 100\ \text{kHz}$		3		pA/ $\sqrt{\text{Hz}}$
Differential Gain Error	NTSC, $G = +2$, $R_L = 150\ \Omega$		0.01		%
Differential Phase Error	NTSC, $G = +2$, $R_L = 150\ \Omega$		0.01		Degrees
DC PERFORMANCE					
Input Offset Voltage			0.2	1.0	mV
Input Offset Voltage Drift	See Figure 54		8		$\mu\text{V}/^\circ\text{C}$
Input Bias Current			2	6.3	μA
Input Bias Current Drift			8		nA/ $^\circ\text{C}$
Input Bias Offset Current			0.2	1.3	μA
Open-Loop Gain	$V_{OUT} = -3\ \text{V to } +3\ \text{V}$	62	64		dB
INPUT CHARACTERISTICS					
Input Resistance	Common-mode/differential		3.6/1.0		M Ω
Input Capacitance	Common-mode		1.3		pF
Input Common-Mode Voltage Range			± 3.8		V
Common-Mode Rejection	$V_{CM} = \pm 1\ \text{V}$	-83	-91		dB
OUTPUT CHARACTERISTICS					
Output Overdrive Recovery Time	$V_{IN} = \pm 3\ \text{V}$, $G = +2$		8		ns
Output Voltage Swing	$R_L = 1\ \text{k}\Omega$	-3.8 to +3.8	-3.9 to +3.9		V
	$R_L = 100\ \Omega$	-3.4 to +3.5	-3.6 to +3.6		V
Output Current			70		mA
Short-Circuit Current	Sinking/sourcing		90/170		mA
Capacitive Load Drive	30% overshoot, $G = +2$		18		pF
POWER SUPPLY					
Operating Range		± 1.65	± 5	± 6	V
Quiescent Current			16	19	mA
Positive Power Supply Rejection	$+V_S = +5\ \text{V to } +6\ \text{V}$, $-V_S = -5\ \text{V}$	-61	-68		dB
Negative Power Supply Rejection	$+V_S = +5\ \text{V}$, $-V_S = -5\ \text{V to } -6\ \text{V}$	-66	-73		dB

SPECIFICATIONS WITH +5 V SUPPLY

$T_A = 25^\circ\text{C}$, $G = +1$, $R_S = 100\ \Omega$, $R_L = 1\ \text{k}\Omega$ to midsupply, unless otherwise noted. Exposed paddle must be floating or connected to $-V_S$.

Table 2.

Parameter	Test Conditions/Comments	Min	Typ	Max	Unit
DYNAMIC PERFORMANCE					
-3 dB Bandwidth	$G = +1$, $V_{OUT} = 0.2\ \text{V p-p}$		900		MHz
	$G = +1$, $V_{OUT} = 2\ \text{V p-p}$	160	200		MHz
	$G = +2$, $V_{OUT} = 0.2\ \text{V p-p}$	320	395		MHz
Bandwidth for 0.1 dB Flatness	$G = +2$, $V_{OUT} = 2\ \text{V p-p}$, $R_L = 150\ \Omega$		60		MHz
Slew Rate	$G = +1$, $V_{OUT} = 2\ \text{V step}$	480	1060		V/ μs
Settling Time to 0.1%	$G = +2$, $V_{OUT} = 2\ \text{V step}$		10		ns
NOISE/HARMONIC PERFORMANCE					
Harmonic Distortion (dBc) HD2/HD3					
	$f_c = 5\ \text{MHz}$, $V_{OUT} = 2\ \text{V p-p}$				
	LFCSP		-89/-83		dBc
	SOIC		-92/-83		dBc
	$f_c = 20\ \text{MHz}$, $V_{OUT} = 2\ \text{V p-p}$				
	LFCSP		-81/-70		dBc
	SOIC		-83/-70		dBc
	$f_c = 70\ \text{MHz}$, $V_{OUT} = 2\ \text{V p-p}$				
	LFCSP		-57/-46		dBc
	SOIC		-57/-46		dBc
Input Voltage Noise	$f = 100\ \text{kHz}$		3		nV/ $\sqrt{\text{Hz}}$
Input Current Noise	$f = 100\ \text{kHz}$		3		pA/ $\sqrt{\text{Hz}}$
Differential Gain Error	NTSC, $G = +2$, $R_L = 150\ \Omega$		0.01		%
Differential Phase Error	NTSC, $G = +2$, $R_L = 150\ \Omega$		0.01		Degrees
DC PERFORMANCE					
Input Offset Voltage			0.5	1.4	mV
Input Offset Voltage Drift	See Figure 54		7		$\mu\text{V}/^\circ\text{C}$
Input Bias Current			2	6.6	μA
Input Bias Current Drift			7		nA/ $^\circ\text{C}$
Input Bias Offset Current			0.2	1.3	μA
Open-Loop Gain	$V_{OUT} = 2\ \text{V to } 3\ \text{V}$	61	63		dB
INPUT CHARACTERISTICS					
Input Resistance	Common-mode/differential		3/0.9		M Ω
Input Capacitance	Common-mode		1.3		pF
Input Common-Mode Voltage Range			1.2 to 3.8		V
Common-Mode Rejection	$V_{CM} = 2\ \text{V to } 3\ \text{V}$	-78	-94		dB
OUTPUT CHARACTERISTICS					
Output Overdrive Recovery Time	$V_{IN} = -0.5\ \text{V to } +3\ \text{V}$, $G = +2$		10		ns
Output Voltage Swing	$R_L = 1\ \text{k}\Omega$	1.2 to 3.8	1.1 to 4.0		V
	$R_L = 100\ \Omega$	1.3 to 3.7	1.2 to 3.8		V
Output Current			55		mA
Short-Circuit Current	Sinking/sourcing		70/140		mA
Capacitive Load Drive	30% overshoot, $G = +2$		15		pF
POWER SUPPLY					
Operating Range		3.3	5	12	V
Quiescent Current			15	18	mA
Positive Power Supply Rejection	$+V_S = +5\ \text{V to } +6\ \text{V}$, $-V_S = 0\ \text{V}$	-65	-67		dB
Negative Power Supply Rejection	$+V_S = +5\ \text{V}$, $-V_S = 0\ \text{V to } -1\ \text{V}$	-70	-73		dB

ABSOLUTE MAXIMUM RATINGS

Table 3.

Parameter	Rating
Supply Voltage	12.6V
Power Dissipation	See Figure 4
Common-Mode Input Voltage	-V _S - 0.7V to +V _S + 0.7V
Differential Input Voltage	±V _S
Exposed Paddle Voltage	-V _S
Storage Temperature Range	-65°C to +125°C
Operating Temperature Range	-40°C to +125°C
Lead Temperature (Soldering 10 sec)	300°C
Junction Temperature	150°C

Stresses at or above those listed under Absolute Maximum Ratings may cause permanent damage to the product. This is a stress rating only; functional operation of the product at these or any other conditions above those indicated in the operational section of this specification is not implied. Operation beyond the maximum operating conditions for extended periods may affect product reliability.

THERMAL RESISTANCE

θ_{JA} is specified for the worst-case conditions; that is, θ_{JA} is specified for the device soldered in the circuit board for surface-mount packages.

Table 4. Thermal Resistance

Package Type	θ _{JA}	θ _{JC}	Unit
SOIC	80	30	°C/W
LFCSP	93	35	°C/W

Maximum Power Dissipation

The maximum safe power dissipation for the AD8045 is limited by the associated rise in junction temperature (T_J) on the die. At approximately 150°C, which is the glass transition temperature, the properties of the plastic change. Even temporarily exceeding this temperature limit may change the stresses that the package exerts on the die, permanently shifting the parametric performance of the AD8045. Exceeding a junction temperature of 175°C for an extended period of time can result in changes in silicon devices, potentially causing degradation or loss of functionality.

The power dissipated in the package (P_D) is the sum of the quiescent power dissipation and the power dissipated in the die due to the AD8045 drive at the output. The quiescent power is the voltage between the supply pins (V_S) times the quiescent current (I_S).

$$P_D = \text{Quiescent Power} + (\text{Total Drive Power} - \text{Load Power})$$

$$P_D = (V_S \times I_S) + \left(\frac{V_S}{2} \times \frac{V_{OUT}}{R_L} \right) - \frac{V_{OUT}^2}{R_L}$$

RMS output voltages should be considered. If R_L is referenced to -V_S, as in single-supply operation, the total drive power is V_S × I_{OUT}. If the rms signal levels are indeterminate, consider the worst case, when V_{OUT} = V_S/4 for R_L to midsupply.

$$P_D = (V_S \times I_S) + \frac{(V_S/4)^2}{R_L}$$

In single-supply operation with R_L referenced to -V_S, worst case is V_{OUT} = V_S/2.

Airflow increases heat dissipation, effectively reducing θ_{JA}. Also, more metal directly in contact with the package leads and exposed paddle from metal traces, through holes, ground, and power planes reduces θ_{JA}.

Figure 4 shows the maximum safe power dissipation in the package vs. the ambient temperature for the exposed paddle SOIC (80°C/W) and LFCSP (93°C/W) package on a JEDEC standard 4-layer board. θ_{JA} values are approximations.

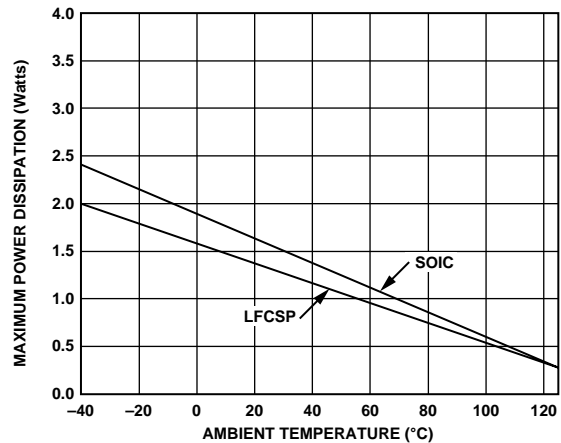

Figure 4. Maximum Power Dissipation vs. Temperature for a 4-Layer Board

ESD CAUTION



ESD (electrostatic discharge) sensitive device. Charged devices and circuit boards can discharge without detection. Although this product features patented or proprietary protection circuitry, damage may occur on devices subjected to high energy ESD. Therefore, proper ESD precautions should be taken to avoid performance degradation or loss of functionality.

PIN CONFIGURATIONS AND FUNCTION DESCRIPTIONS

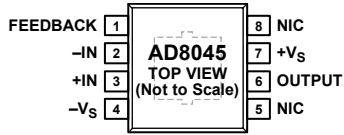

NOTES
 1. NIC = NO INTERNAL CONNECTION.
 2. THE EXPOSED PADDLE MUST BE CONNECTED TO $-V_S$ OR LEFT ELECTRICALLY ISOLATED (FLOATING).

Figure 5. 8-Lead SOIC Pin Configuration

04814-0-003

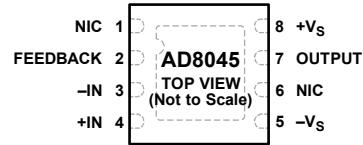

NOTES
 1. NIC = NO INTERNAL CONNECTION.
 2. THE EXPOSED PADDLE MUST BE CONNECTED TO $-V_S$ OR LEFT ELECTRICALLY ISOLATED (FLOATING).

Figure 6. 8-Lead LFCSP Pin Configuration

04814-0-004

Table 5. Pin Function Descriptions

Pin No.		Mnemonic	Description
SOIC	LFCSP		
1	2	FEEDBACK	Feedback Pin.
2	3	-IN	Inverting Input.
3	4	+IN	Noninverting Input.
4	5	$-V_S$	Negative Supply.
5, 8	1, 6	NIC	No Internal Connection.
6	7	OUTPUT	Output.
7	8	$+V_S$	Positive Supply.
		EPAD	Exposed Paddle. The exposed paddle must be connected to $-V_S$ or left electrically isolated (floating).

TYPICAL PERFORMANCE CHARACTERISTICS

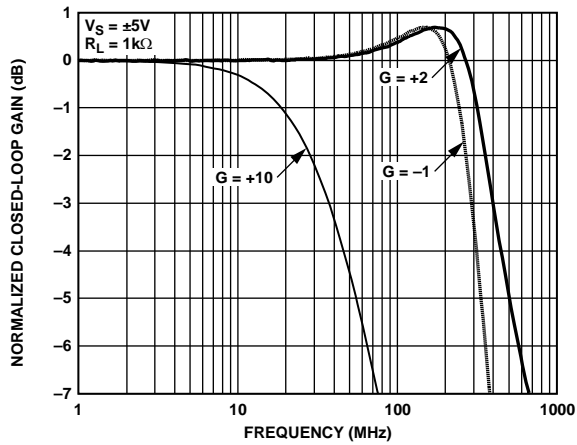

Figure 7. Small Signal Frequency Response for Various Gains

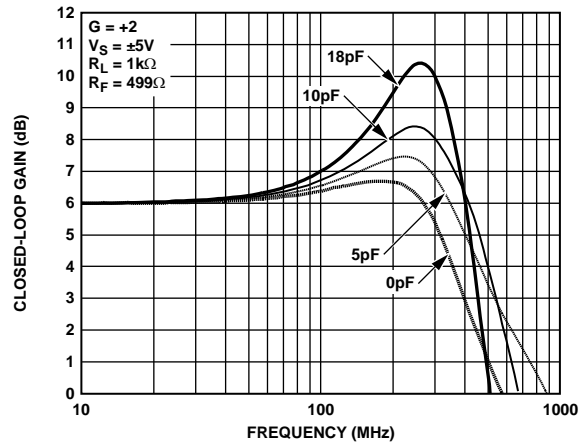

Figure 10. Small Signal Frequency Response for Various Capacitive Loads

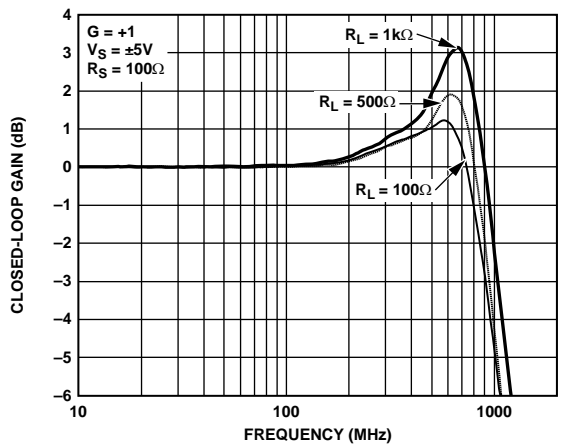

Figure 8. Small Signal Frequency Response for Various Loads

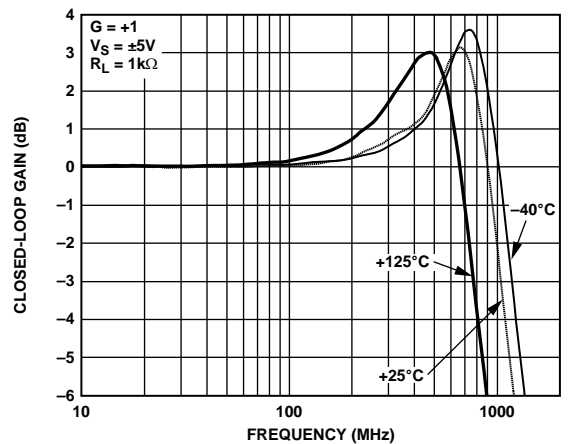

Figure 11. Small Signal Frequency Response for Various Temperatures

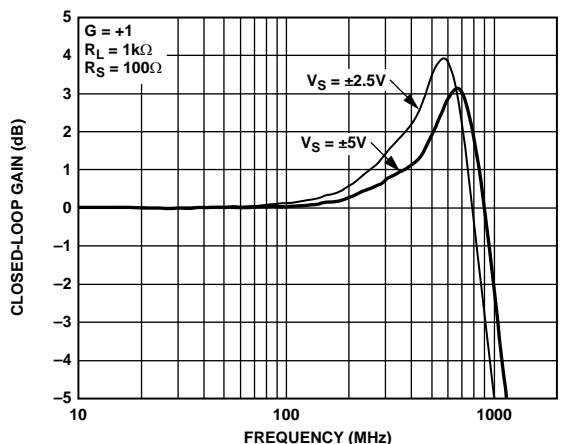

Figure 9. Small Signal Frequency Response for Various Supplies

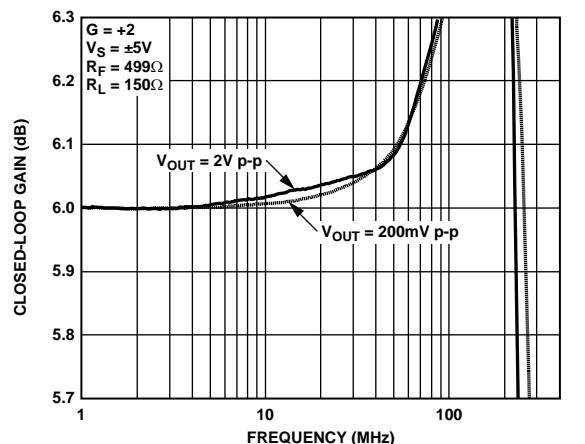

Figure 12. 0.1 dB Flatness vs. Frequency for Various Output Voltages

04814-0-049

04814-0-048

04814-0-050

04814-0-052

04814-0-051

04814-0-039

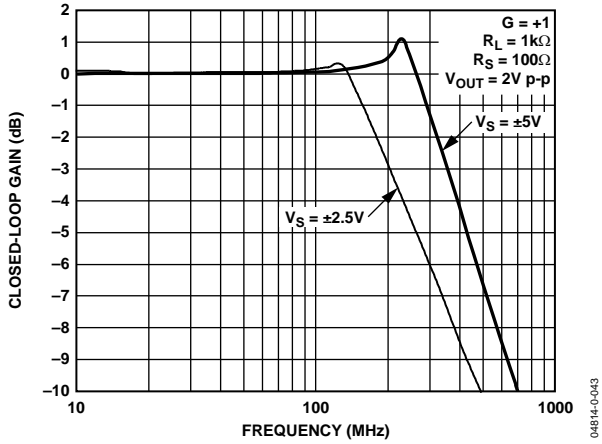

Figure 13. Large Signal Frequency Response for Various Supplies

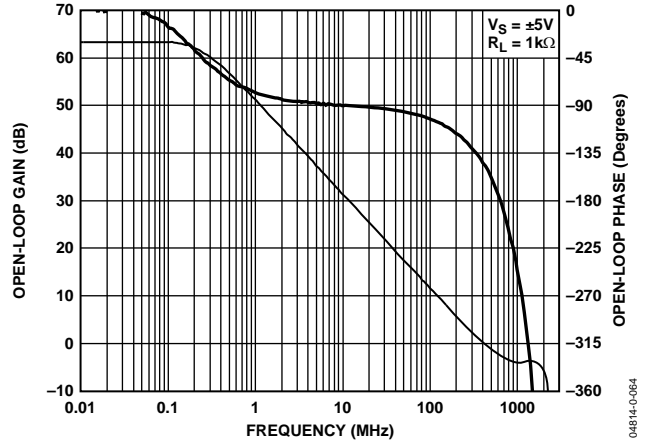

Figure 16. Open-Loop Gain and Phase vs. Frequency

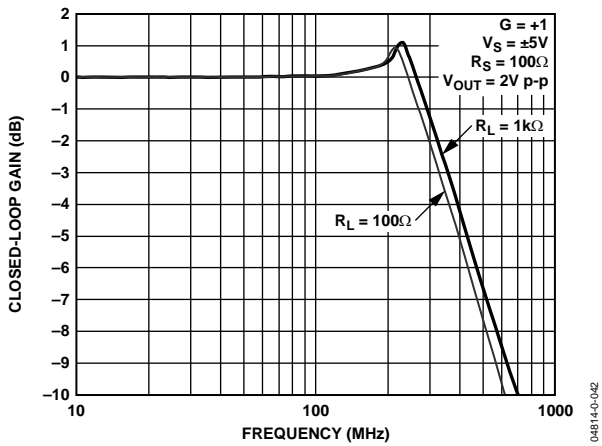

Figure 14. Large Signal Frequency Response for Various Loads

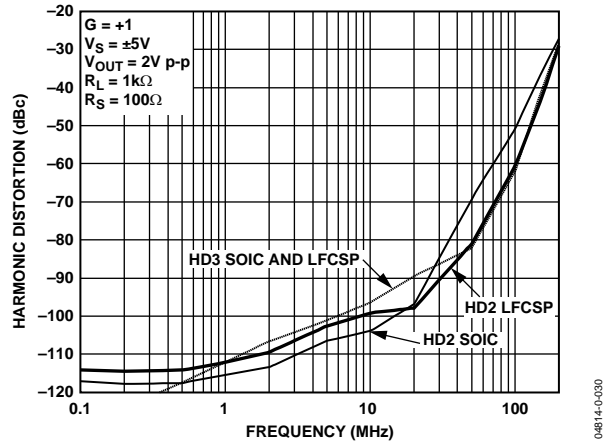

Figure 17. Harmonic Distortion vs. Frequency for Various Packages

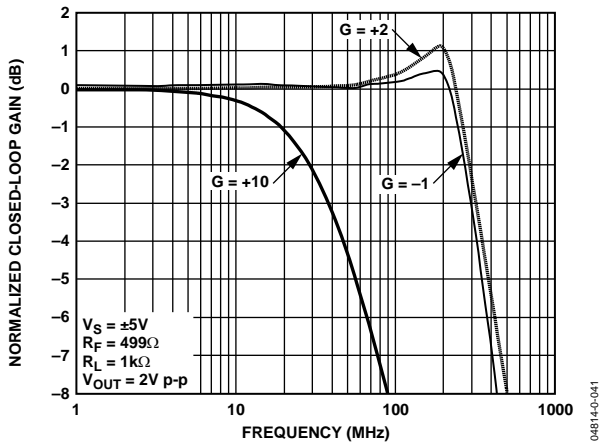

Figure 15. Large Signal Frequency Response for Various Gains

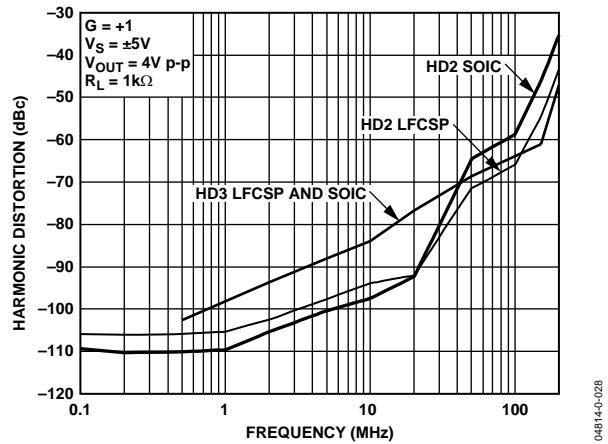

Figure 18. Harmonic Distortion vs. Frequency for Various Packages

04814-0-043

04814-0-064

04814-0-042

04814-0-030

04814-0-041

04814-0-028

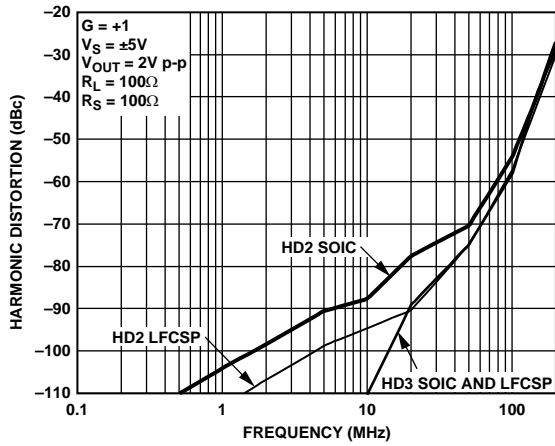

Figure 19. Harmonic Distortion vs. Frequency for Various Packages

04814-0-032

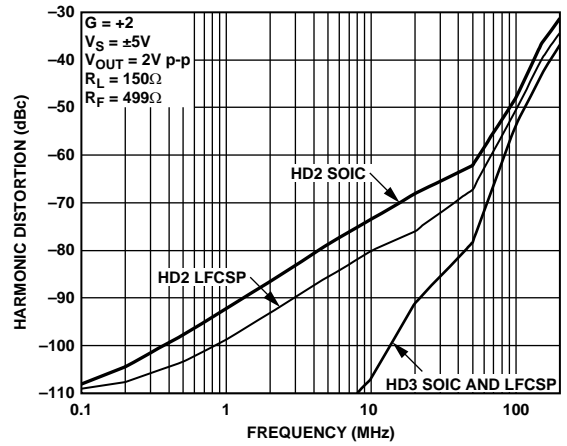

Figure 22. Harmonic Distortion vs. Frequency for Various Packages

04814-0-033

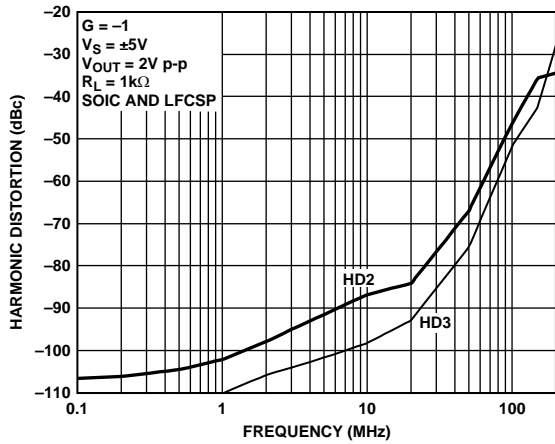

Figure 20. Harmonic Distortion vs. Frequency for Various Packages

04814-0-036

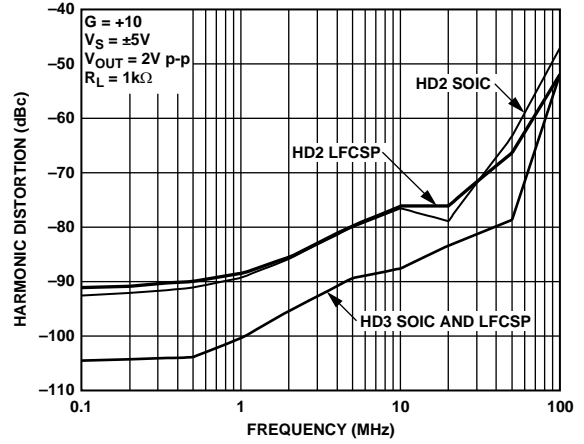

Figure 23. Harmonic Distortion vs. Frequency for Various Packages

04814-0-034

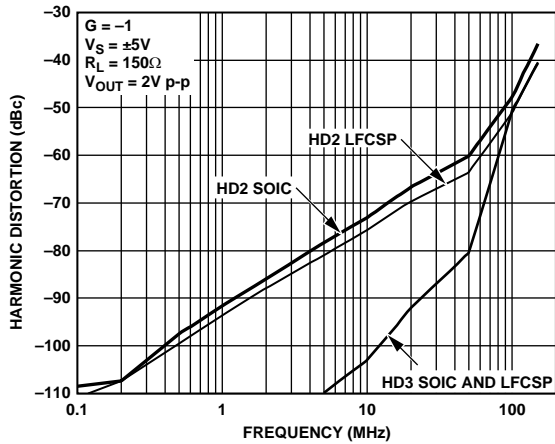

Figure 21. Harmonic Distortion vs. Frequency for Various Packages

04814-0-037

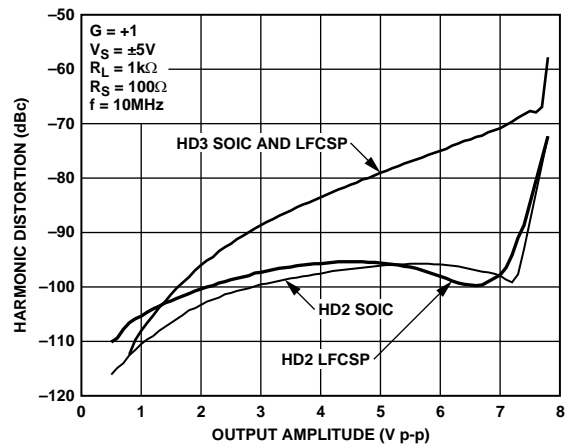
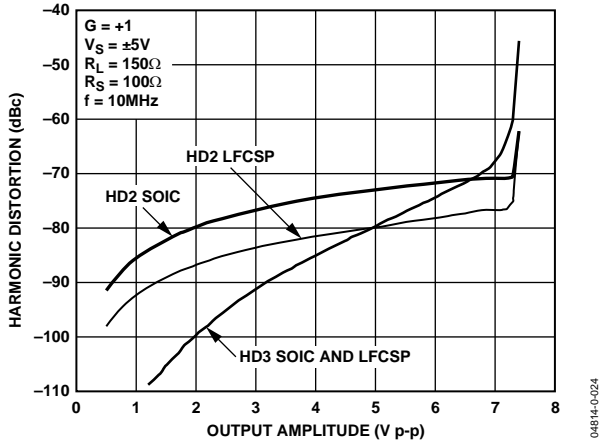

Figure 24. Harmonic Distortion vs. Output Voltage for Various Packages

04814-0-025



04814-0-024

Figure 25. Harmonic Distortion vs. Output Voltage for Various Packages

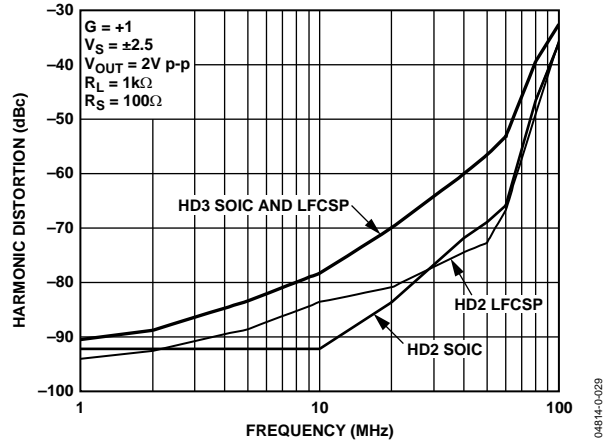

04814-0-023

Figure 28. Harmonic Distortion vs. Frequency for Various Packages

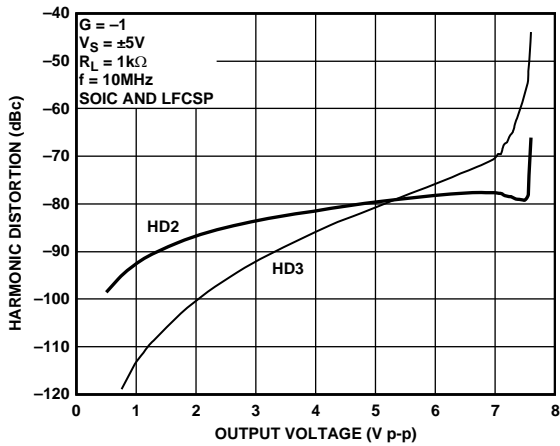

04814-0-026

Figure 26. Harmonic Distortion vs. Output Voltage

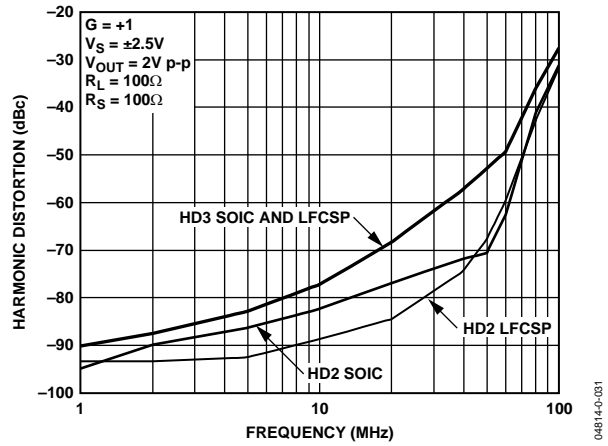

04814-0-031

Figure 29. Harmonic Distortion vs. Frequency for Various Packages

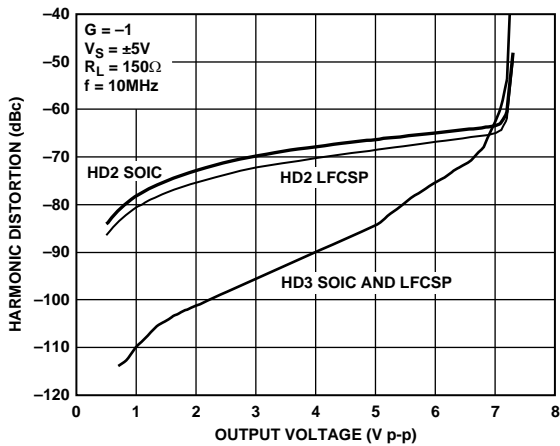

04814-0-027

Figure 27. Harmonic Distortion vs. Output Voltage

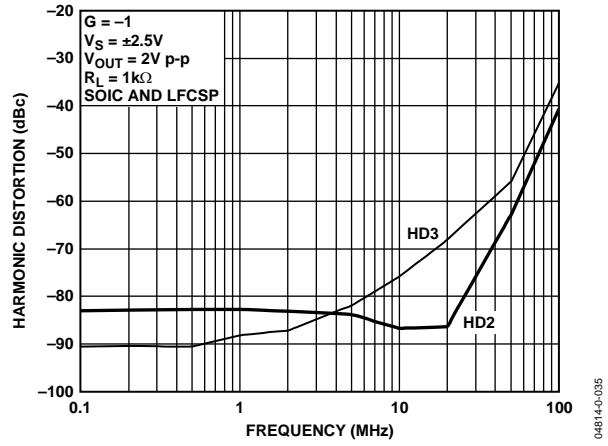

04814-0-035

Figure 30. Harmonic Distortion vs. Frequency for Various Packages

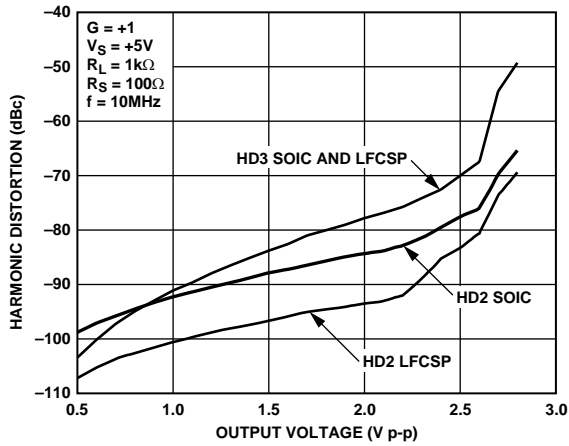

Figure 31. Harmonic Distortion vs. Output Voltage for Various Packages

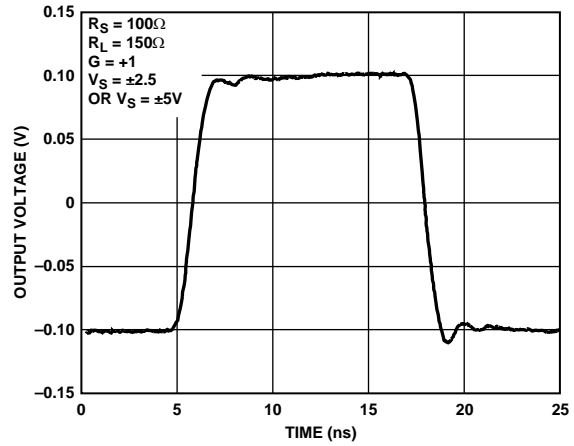

Figure 34. Small Signal Transient Response for Various Supplies and Loads

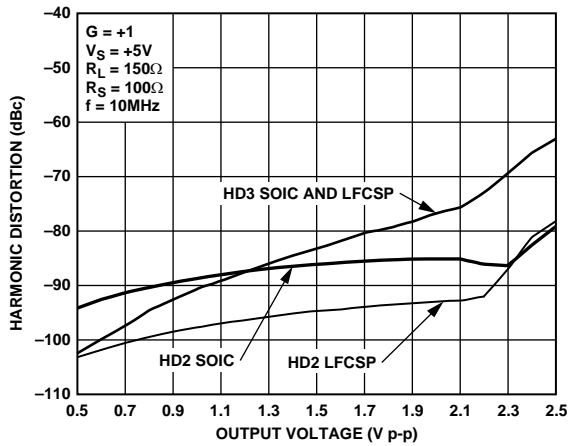

Figure 32. Harmonic Distortion vs. Output Voltage for Various Packages

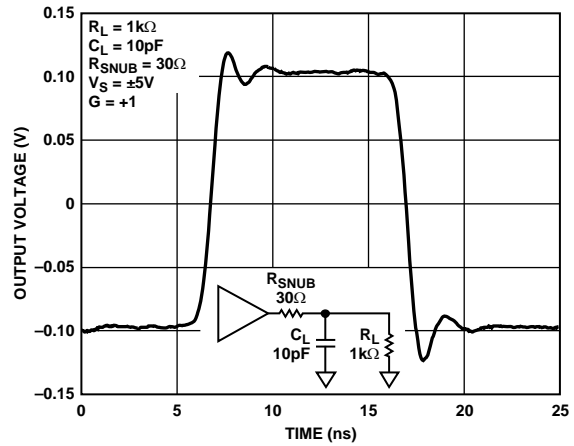

Figure 35. Small Signal Transient Response for Various Supplies and Loads

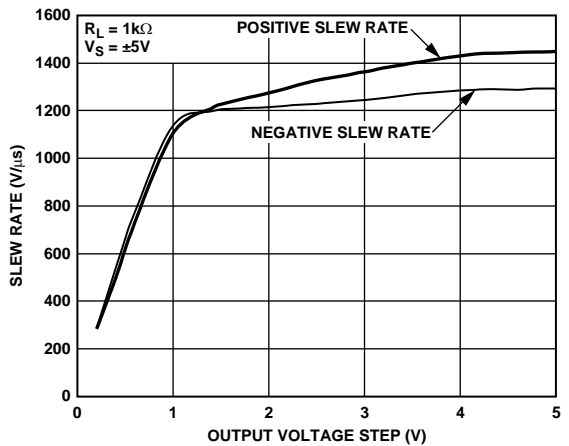

Figure 33. Slew Rate vs. Output Voltage

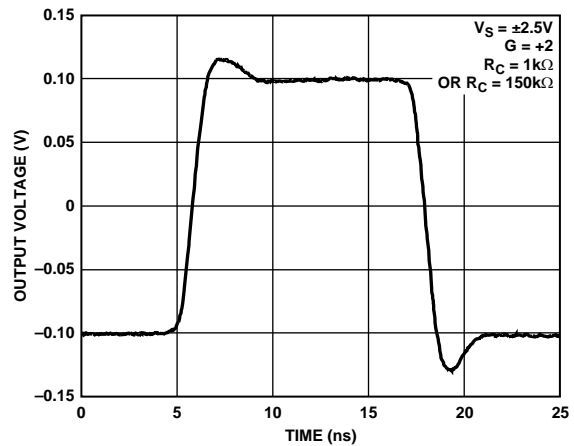

Figure 36. Small Signal Transient Response for Various Loads

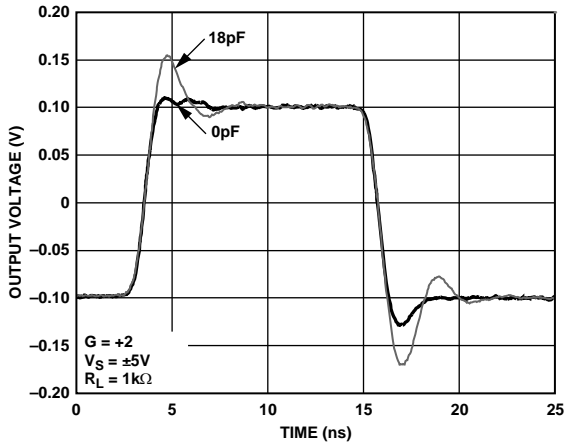

Figure 37. Small Signal Transient Response with Capacitive Load

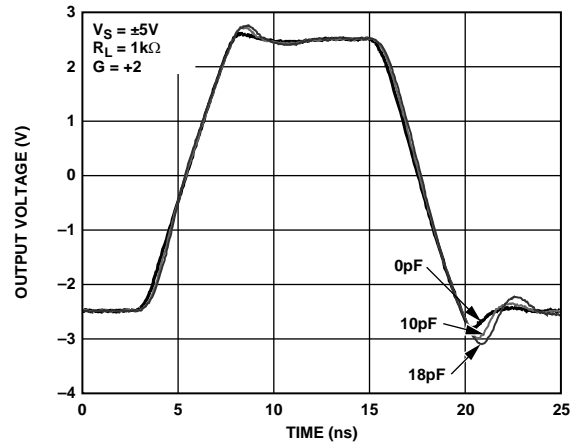

Figure 40. Large Signal Transient Response with Capacitive Load

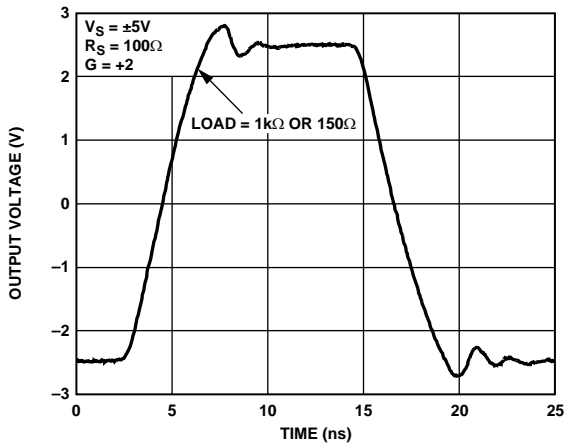

Figure 38. Large Signal Transient Response for Various Loads

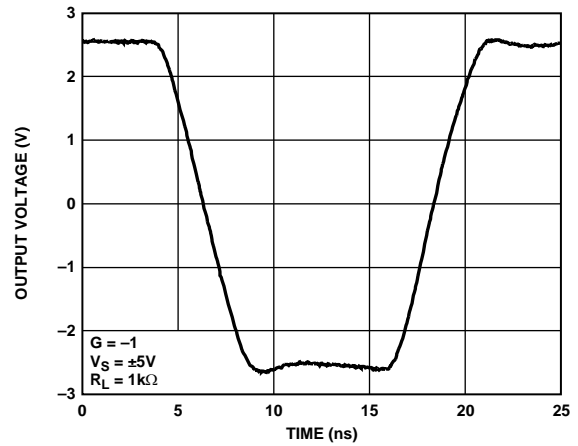

Figure 41. Large Signal Transient Response, Inverting

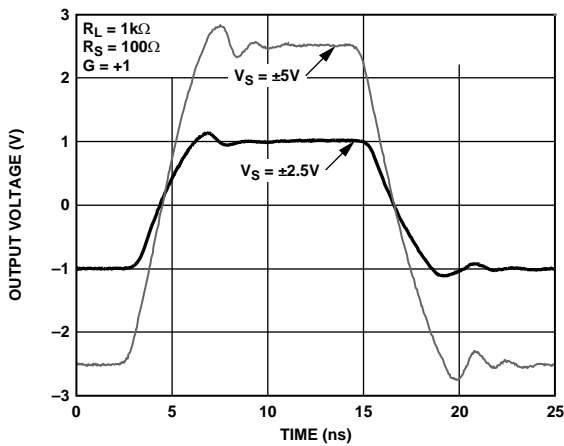

Figure 39. Large Signal Transient Response for Various Supplies

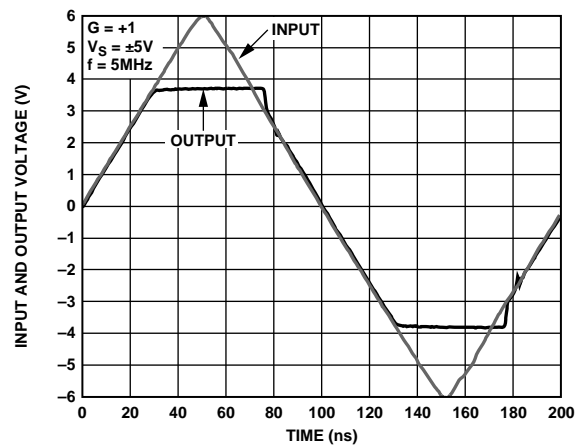

Figure 42. Input Overdrive Recovery

04814-0-015

04814-0-018

04814-0-016

04814-0-019

04814-0-017

04814-0-021

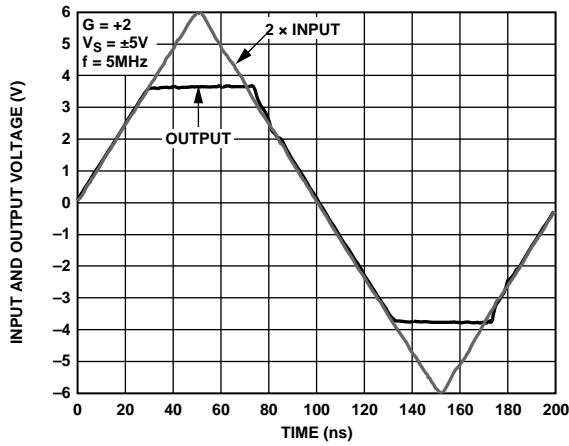

Figure 43. Output Overdrive Recovery

04814-0-062

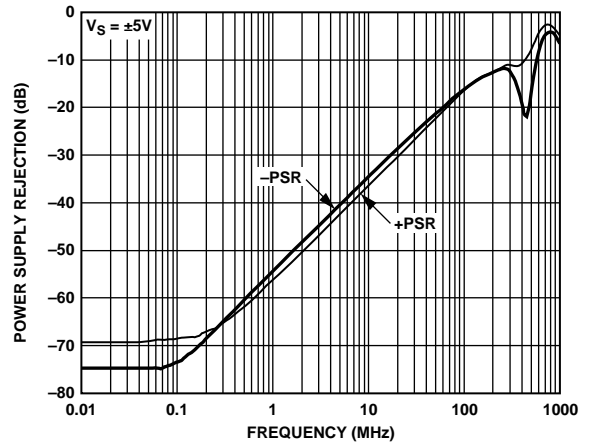

Figure 46. Power Supply Rejection vs. Frequency

04814-0-045

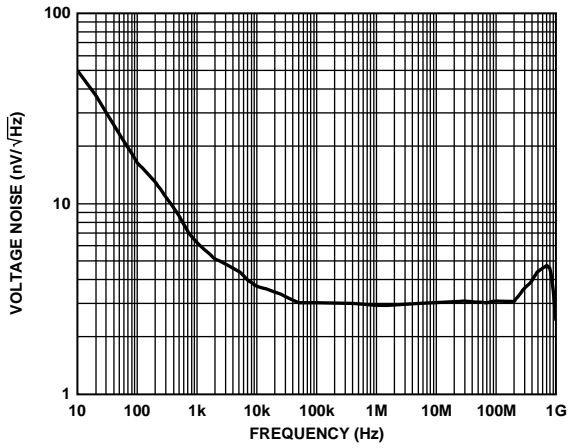

Figure 44. Voltage Noise vs. Frequency

04814-0-053

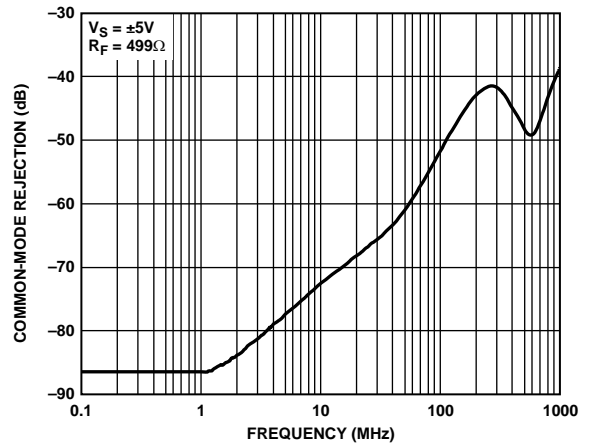

Figure 47. Common-Mode Rejection vs. Frequency

04814-0-020

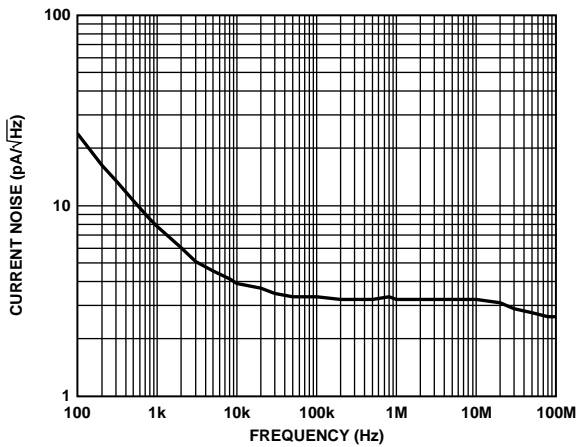

Figure 45. Current Noise vs. Frequency

04814-0-078

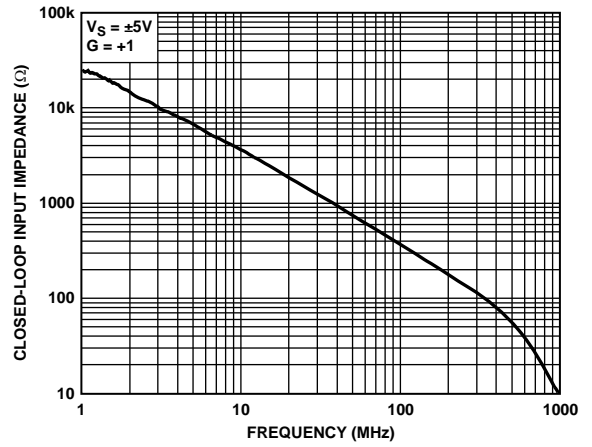

Figure 48. Input Impedance vs. Frequency

04814-0-054

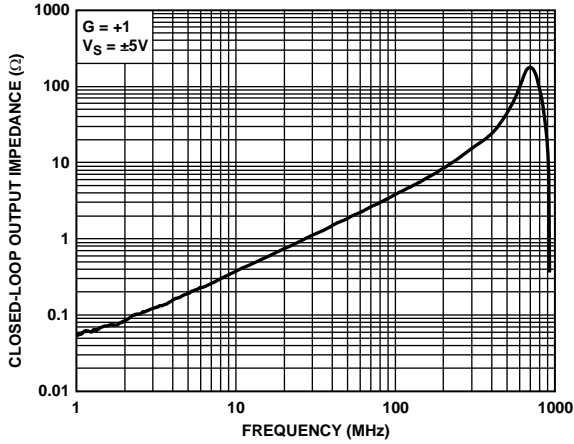

Figure 49. Output Impedance vs. Frequency

04814-0-065

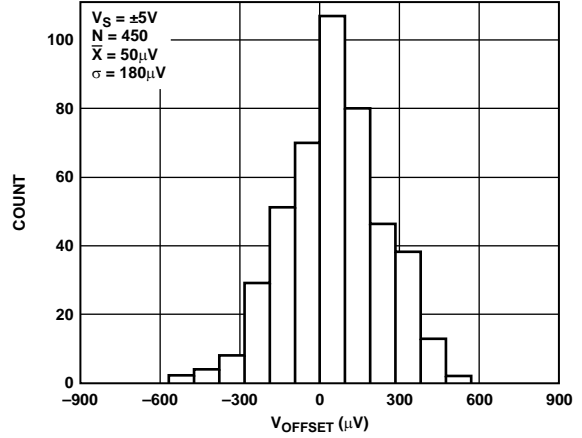

Figure 52. V_{OS} Distribution for $V_S = \pm 5V$

04814-0-063

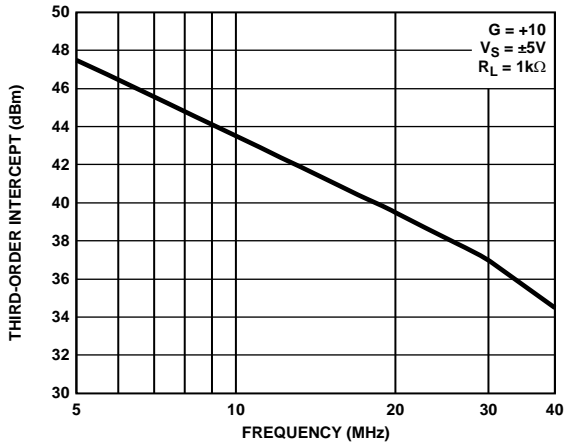

Figure 50. Third-Order Intercept vs. Frequency

04814-0-040

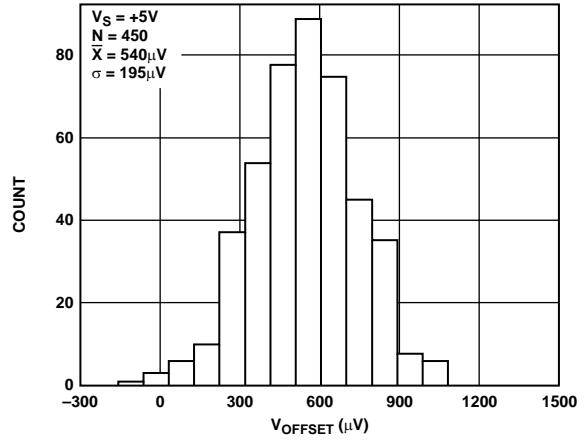

Figure 53. V_{OS} Distribution for $V_S = +5V$

04814-0-077

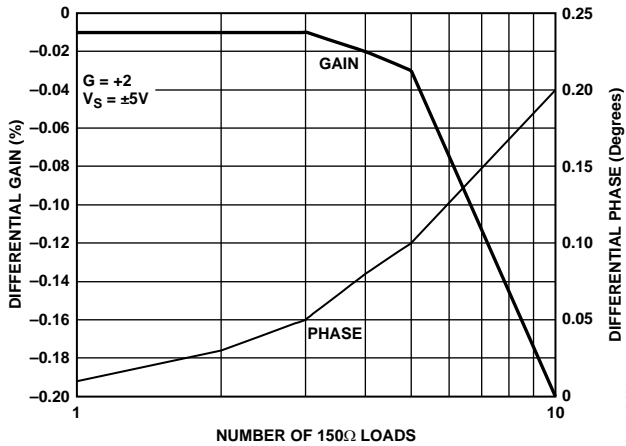

Figure 51. Differential Gain and Phase vs. Number of $150\ \Omega$ Loads

04814-0-021

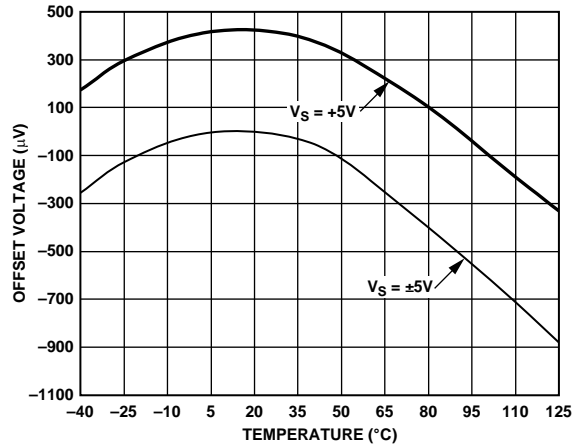

Figure 54. Offset Voltage vs. Temperature for Various Supplies

04814-0-058

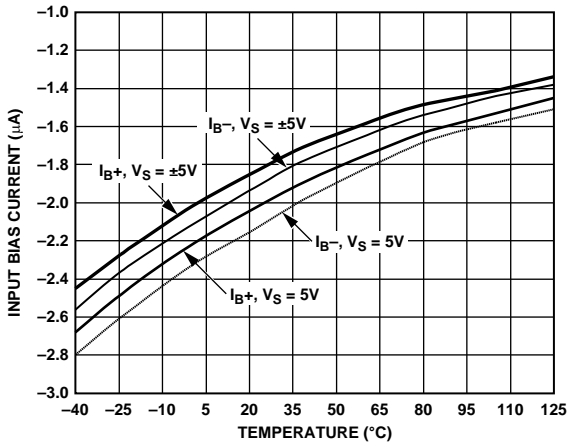

Figure 55. Input Bias Current vs. Temperature for Various Supplies

04814-0-059

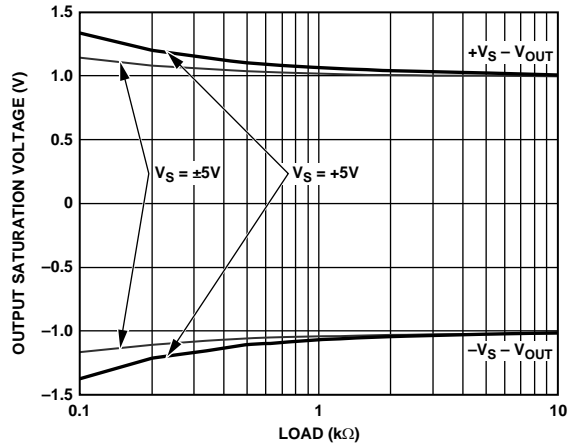

Figure 58. Output Saturation Voltage vs. Load for Various Supplies

04814-0-044

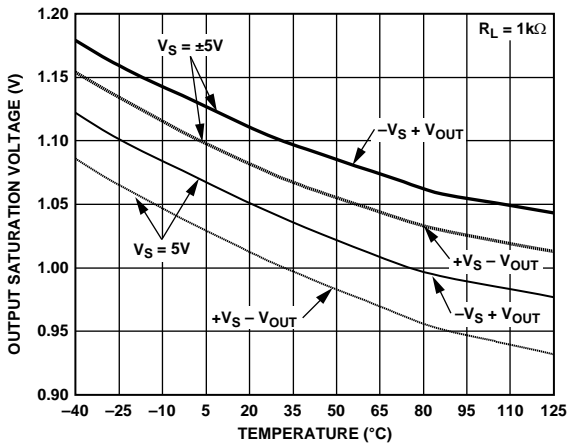

Figure 56. Output Saturation Voltage vs. Temperature for Various Supplies

04814-0-057

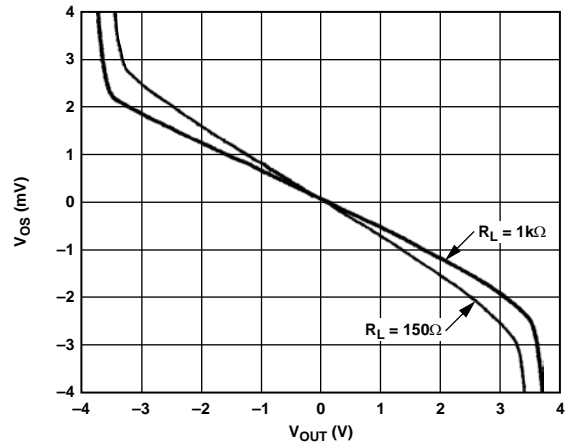

Figure 59. Input Offset Voltage vs. Output Voltage for Various Loads

04814-0-047

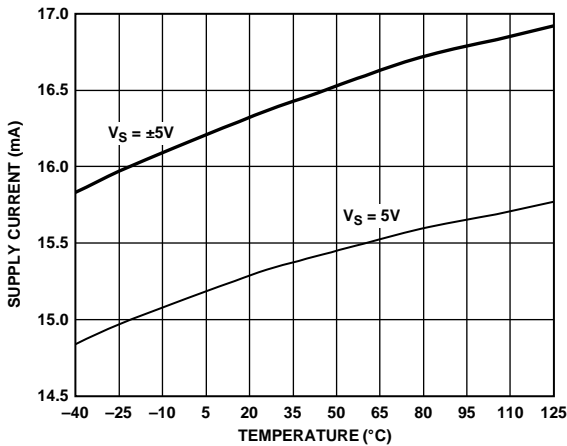

Figure 57. Supply Current vs. Temperature for Various Supplies

04814-0-056

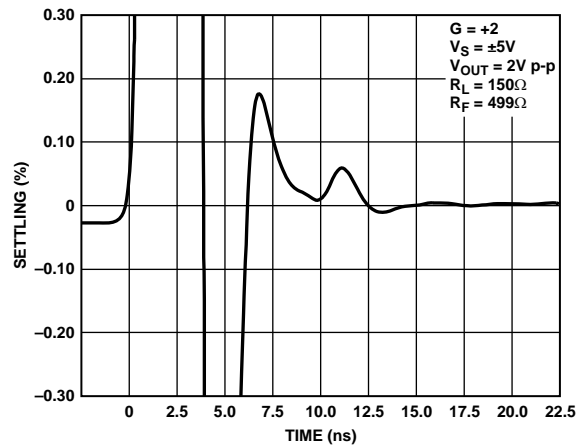

Figure 60. Short Term 0.1% Settling Time

04814-0-046

CIRCUIT CONFIGURATIONS

WIDEBAND OPERATION

Figure 61 and Figure 62 show the recommended circuit configurations for noninverting and inverting amplifiers. In unity-gain ($G = +1$) applications, R_S helps to reduce high frequency peaking. It is not needed for any other configurations. For more information on layout, see the Printed Circuit Board Layout section.

The resistor at the output of the amplifier, labeled R_{SNUB} , is used only when driving large capacitive loads. Using R_{SNUB} improves stability and minimizes ringing at the output. For more information, see the Driving Capacitive Loads section.

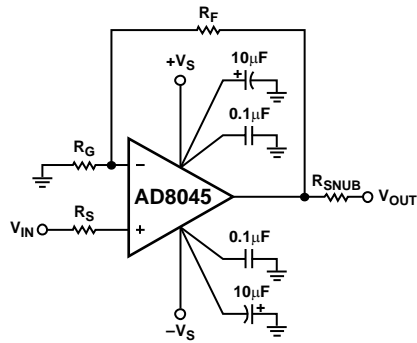

Figure 61. Noninverting Configuration

04814-0-074

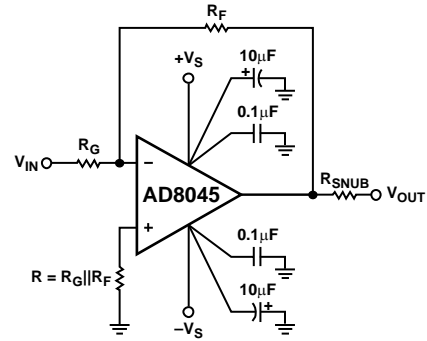

Figure 62. Inverting Configuration

04814-0-075

THEORY OF OPERATION

The AD8045 is a high speed voltage feedback amplifier fabricated on the Analog Devices second generation extra fast complementary bipolar (XFCB) process. An H-bridge input stage is used to attain a 1400 V/ μ s slew rate and low distortion in addition to a low 3 nV/ $\sqrt{\text{Hz}}$ input voltage noise. Supply current and offset voltage are laser trimmed for optimum performance.

FREQUENCY RESPONSE

The open-loop response of the AD8045 over the frequency can be approximated by the integrator response shown in Figure 63.

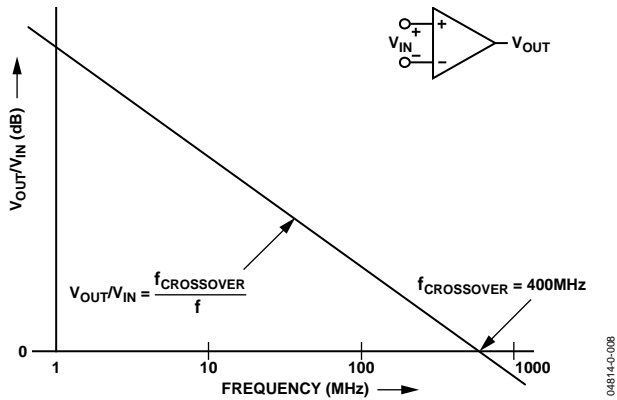

Figure 63. Open-Loop Response

The closed-loop transfer function for the noninverting configuration is shown in Figure 64 and is written as

$$\frac{V_{OUT}}{V_{IN}} = \frac{2 \pi \times f_{CROSSOVER} \times (R_G + R_F)}{(R_F + R_G)s + 2 \pi \times f_{CROSSOVER} \times R_G}$$

where:

s is $(2 \pi j)f$.

$f_{CROSSOVER}$ is the frequency where the open-loop gain of the amplifier equals 1 (0 dB).

DC gain is therefore

$$\frac{V_{OUT}}{V_{IN}} = \frac{(R_G + R_F)}{R_G}$$

Closed-loop -3 dB bandwidth equals

$$\frac{V_{OUT}}{V_{IN}} = f_{CROSSOVER} \times \frac{R_G}{(R_G + R_F)}$$

The closed-loop bandwidth is inversely proportional to the noise gain of the op amp circuit, $(R_F + R_G)/R_G$. This simple model can be used to predict the -3 dB bandwidth for noise gains above +2. The actual bandwidth of circuits with noise gains at or below +2 is higher due to the influence of other poles present in the real op amp.

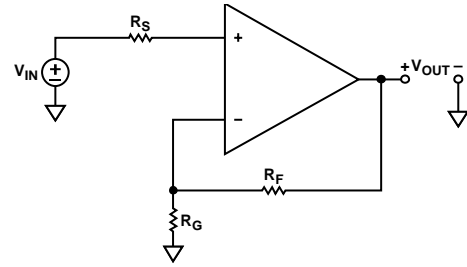

Figure 64. Noninverting Configuration

DC ERRORS

Figure 65 shows the dc error contributions. The total output error voltage is

$$V_{OUT (ERROR)} = -I_{B+} R_S \left(\frac{R_G + R_F}{R_G} \right) + I_{B-} R_F + V_{OS} \left(\frac{R_G + R_F}{R_G} \right)$$

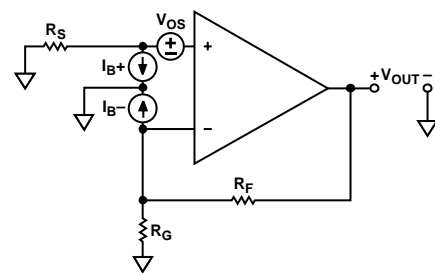

Figure 65. Amplifier DC Errors

The voltage error due to I_{B+} and I_{B-} is minimized if $R_S = R_F || R_G$. To include the effects of common-mode and power supply rejection, model V_{OS} as

$$V_{OS} = V_{OS_{nom}} + \frac{\Delta V_S}{PSR} + \frac{\Delta V_{CM}}{CMR}$$

where:

$V_{OS_{nom}}$ is the offset voltage at nominal conditions.

ΔV_S is the change in the power supply voltage from nominal conditions.

PSR is the power supply rejection.

CMR is the common-mode rejection.

ΔV_{CM} is the change in common-mode voltage from nominal conditions.

OUTPUT NOISE

Figure 66 shows the contributors to the noise at the output of a noninverting configuration.

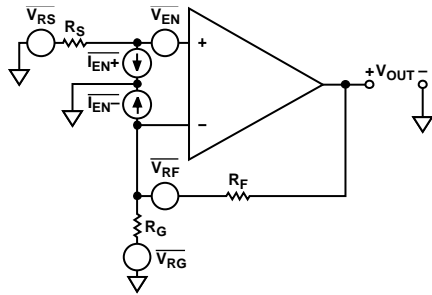

Figure 66. Amplifier DC Errors

$\overline{V_{en}}$, $\overline{I_{N+}}$, and $\overline{I_{N-}}$ are due to the amplifier. V_{RF} , V_{RG} , and V_{RS} are due to the feedback network resistors, R_G and R_F , and the source resistor, R_S . The total output voltage noise, $\overline{V_{OUT_EN}}$, is the rms sum of all the contributions.

$$\overline{V_{OUT_EN}} = \sqrt{(G_n \times \overline{V_{en}})^2 + (\overline{I_{N+}} \times R_S \times G_n)^2 + (\overline{I_{N-}} \times R_F \parallel R_G \times G_n)^2 + 4kTR_f + 4kTR_G(G_n)^2 + 4kTR_S(G_n)^2}$$

where:

G_n is the noise gain $\left(\frac{R_F + R_G}{R_G}\right)$.

$\overline{V_{en}}$ is the op amp input voltage noise.

$\overline{I_N}$ is the op amp input current noise.

Table 6 lists the expected output voltage noise spectral density for several gain configurations.

Table 6. Noise and Bandwidth for Various Gains

Gain	R _F	R _G	R _S	-3 dB Bandwidth ¹	Output Noise (nV/√Hz)
+1	0	—	100	1 GHz	3.3
+2	499	499	0	400 MHz	7.4
+5	499	124	0	90 MHz	16.4
+10	499	56	0	40 MHz	31
-1	499	499	N/A ²	300 MHz	7.4

¹ R_L = 1 kΩ.

² N/A means not applicable.

APPLICATIONS INFORMATION

LOW DISTORTION PINOUT

The **AD8045** LFCSP features an Analog Devices new low distortion pinout. The new pinout provides two advantages over the traditional pinout. First, improved second harmonic distortion performance, which is accomplished by the physical separation of the noninverting input pin and the negative power supply pin. Second, the simplification of the layout due to the dedicated feedback pin and easy routing of the gain set resistor back to the inverting input pin. This allows a compact layout, which helps to minimize parasitics and increase stability.

The traditional SOIC pinout has been slightly modified as well to incorporate a dedicated feedback pin. Pin 1, previously a no connect pin on the amplifier, is now a dedicated feedback pin. The new pinout reduces parasitics and simplifies the board layout.

Existing applications that use the traditional SOIC pinout can take full advantage of the outstanding performance offered by the **AD8045**. An electrical insulator may be required if the SOIC rests on the ground plane or other metal trace. This is covered in more detail in the Exposed Paddle section of this data sheet. In existing designs, which have Pin 1 tied to ground or to another potential, simply lift Pin 1 of the **AD8045** or remove the potential on the Pin 1 solder pad. The designer does not need to use the dedicated feedback pin to provide feedback for the **AD8045**. The output pin of the **AD8045** can still be used to provide feedback to the inverting input of the **AD8045**.

HIGH SPEED ADC DRIVER

When used as an ADC driver, the **AD8045** offers results comparable to transformers in distortion performance. Many ADC applications require that the analog input signal be dc-coupled and operate over a wide frequency range. Under these requirements, operational amplifiers are very effective interfaces to ADCs. An op amp interface provides the ability to amplify and level shift the input signal to be compatible with the input range of the ADC. Unlike transformers, operational amplifiers can be operated over a wide frequency range down to and including dc.

Figure 67 shows the **AD8045** as a dc-coupled differential driver for the **AD9244**, a 14-bit 65 MSPS ADC. The two amplifiers are configured in noninverting and inverting modes. Both amplifiers are set with a noise gain of +2 to provide better bandwidth matching. The inverting amplifier is set for a gain of -1, while the noninverting is set for a gain of +2. The noninverting input is divided by 2 in order to normalize its output and make it equal to the inverting output.

This dc-coupled differential driver is best suited for ± 5 V operation in which optimum distortion performance is required and the input signal is ground referenced.

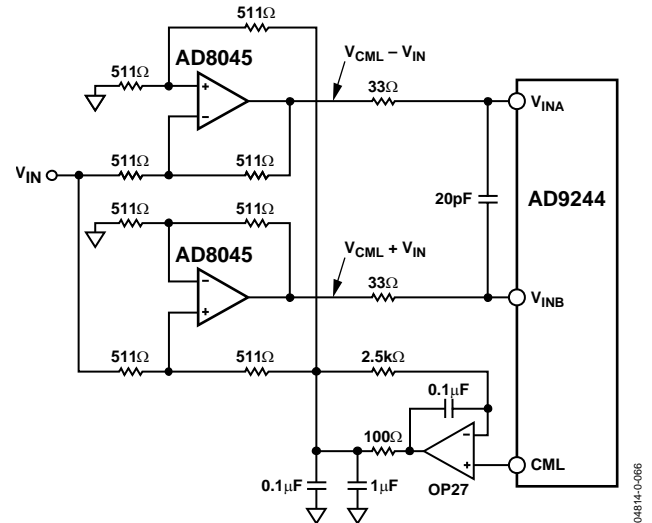

Figure 67. High Speed ADC Driver

The outputs of the **AD8045** devices are centered about the 2.5 V common-mode range of the **AD9244**. The common-mode reference voltage from the **AD9244** is buffered and filtered via the **OP27** and fed to the noninverting resistor network used in the level shifting circuit.

The spurious-free dynamic range (SFDR) performance is shown in Figure 68. Figure 69 shows a 50 MHz single-tone FFT performance.

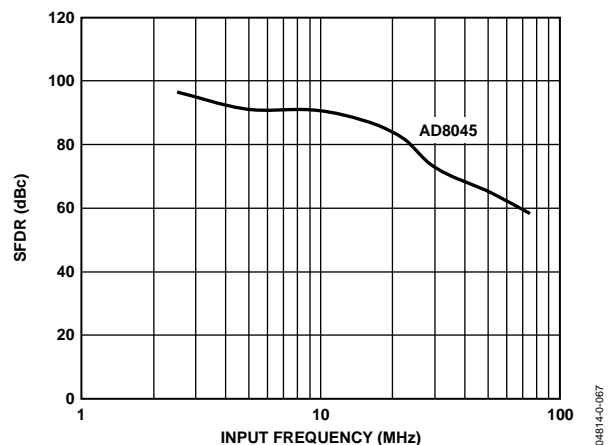

Figure 68. SFDR vs. Frequency

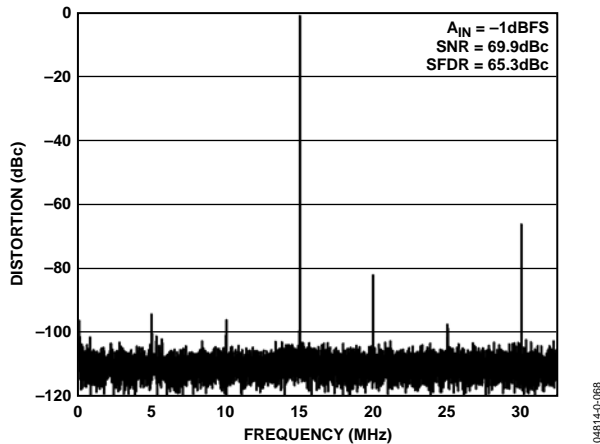

Figure 69. Single-Tone FFT, $F_{IN} = 50$ MHz, Sample Rate = 65 MSPS
Shown in the First Nyquist Zone

90 MHz ACTIVE LOW-PASS FILTER (LPF)

Active filters are used in many applications such as antialiasing filters and high frequency communication IF strips.

With a 400 MHz gain bandwidth product and high slew rate, the AD8045 is an ideal candidate for active filters. Figure 70 shows the frequency response of the 90 MHz LPF. In addition to the bandwidth requirements, the slew rate must be capable of supporting the full power bandwidth of the filter. In this case, a 90 MHz bandwidth with a 2 V p-p output swing requires at least 1200 V/ μ s. This performance is achievable only at 90 MHz because of the wide bandwidth and high slew rate of the AD8045.

The circuit shown in Figure 73 is a 90 MHz, 4-pole, Sallen-Key, LPF. The filter comprises two identical cascaded Sallen-Key LPF sections, each with a fixed gain of $G = +2$. The net gain of the filter is equal to $G = +4$ or 12 dB. The actual gain shown in Figure 70 is only 6 dB. This is due to the output voltage being divided in half by the series matching termination resistor, R_T , and the load resistor.

Setting the resistors and capacitors equal to each other greatly simplifies the design equations for the Sallen-Key filter. The corner frequency, or -3 dB frequency, can be described by the equation

$$f_c = \frac{1}{2\pi RC}$$

The quality factor, or Q , is shown in the equation

$$Q = \frac{1}{3-K}$$

The gain, or K , of the circuits is

$$\text{First Stage } K = \frac{R3}{R4} + 1, \text{ Second Stage } K = \frac{R8}{R7} + 1$$

Resistor values are kept low for minimal noise contribution, offset voltage, and optimal frequency response. Due to the low capacitance values used in the filter circuit, the PCB layout and minimization of parasitics is critical. A few picofarads can detune the filters corner frequency, f_c . The capacitor values shown in Figure 73 actually incorporate some stray PCB capacitance.

Capacitor selection is critical for optimal filter performance. Capacitors with low temperature coefficients, such as NPO ceramic capacitors and silver mica, are good choices for filter elements.

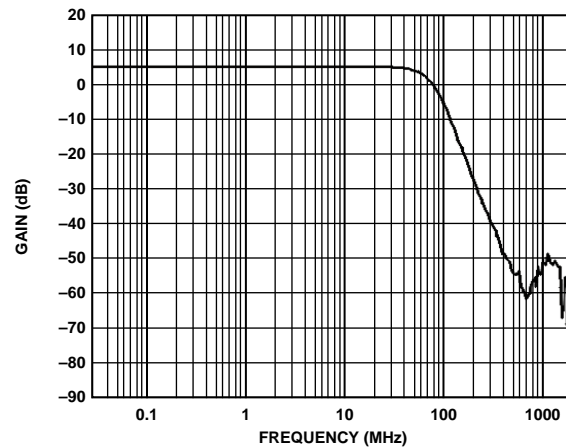

Figure 70. 90 MHz Low-Pass Filter Response

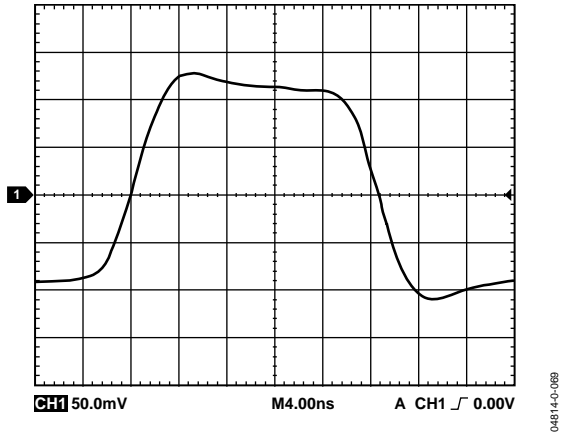

Figure 71. Small Signal Transient Response of 90 MHz LPF

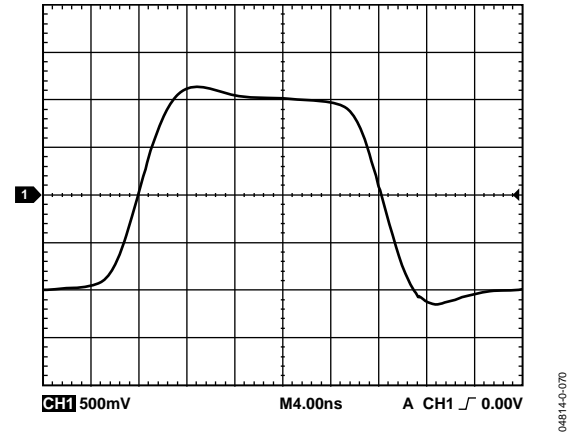

Figure 72. Large Signal Transient Response of 90 MHz LPF

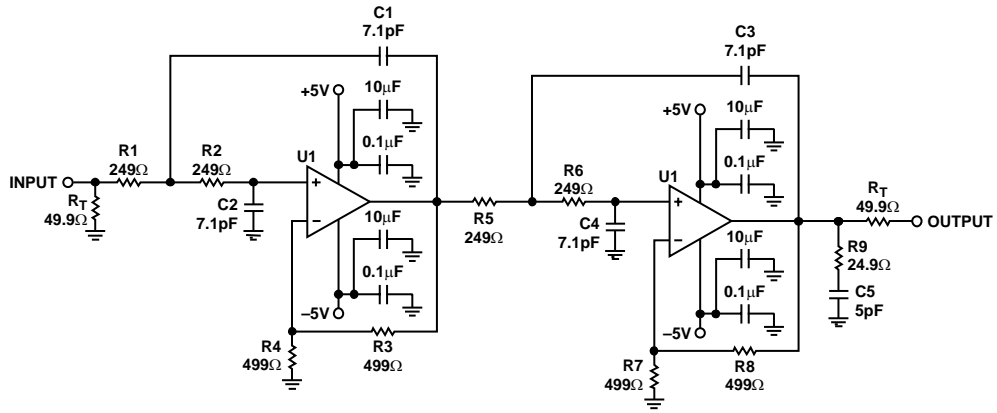

Figure 73. 4-Pole, 90 MHz, Sallen-Key Low-Pass Filter

PRINTED CIRCUIT BOARD LAYOUT

Laying out the printed circuit board (PCB) is usually the last step in the design process and often proves to be one of the most critical. A brilliant design can be rendered useless because of a poor or sloppy layout. Since the AD8045 can operate into the RF frequency spectrum, high frequency board layout considerations must be taken into account. The PCB layout, signal routing, power supply bypassing, and grounding all must be addressed to ensure optimal performance.

SIGNAL ROUTING

The AD8045 LFCSP features the new low distortion pinout with a dedicated feedback pin and allows a compact layout. The dedicated feedback pin reduces the distance from the output to the inverting input, which greatly simplifies the routing of the feedback network.

When laying out the AD8045 as a unity-gain amplifier, it is recommended that a short, but wide, trace between the dedicated feedback pin and the inverting input to the amplifier be used to minimize stray parasitic inductance.

To minimize parasitic inductances, ground planes should be used under high frequency signal traces. However, the ground plane should be removed from under the input and output pins to minimize the formation of parasitic capacitors, which degrades phase margin. Signals that are susceptible to noise pickup should be run on the internal layers of the PCB, which can provide maximum shielding.

POWER SUPPLY BYPASSING

Power supply bypassing is a critical aspect of the PCB design process. For best performance, the AD8045 power supply pins need to be properly bypassed.

A parallel connection of capacitors from each of the power supply pins to ground works best. Paralleling different values and sizes of capacitors helps to ensure that the power supply pins see a low ac impedance across a wide band of frequencies. This is important for minimizing the coupling of noise into the amplifier. Starting directly at the power supply pins, the smallest value and sized component should be placed on the same side of the board as the amplifier, and as close as possible to the amplifier, and connected to the ground plane. This process should be repeated for the next larger value capacitor. It is recommended for the AD8045 that a 0.1 μF ceramic 0508 case be used. The 0508 offers low series inductance and excellent high frequency performance. The 0.1 μF case provides low impedance at high frequencies. A 10 μF electrolytic capacitor should be placed in parallel with the 0.1 μF . The 10 μF capacitor provides low ac impedance at low frequencies. Smaller values of electrolytic capacitors may be used depending on the circuit requirements. Additional smaller value capacitors help to provide a low impedance path for unwanted noise out to higher frequencies but are not always necessary.

Placement of the capacitor returns (grounds), where the capacitors enter into the ground plane, is also important. Returning the capacitors grounds close to the amplifier load is critical for distortion performance. Keeping the capacitors distance short, but equal from the load, is optimal for performance.

In some cases, bypassing between the two supplies can help to improve PSRR and to maintain distortion performance in crowded or difficult layouts. It is brought to the attention of the designer here as another option to improve performance.

Minimizing the trace length and widening the trace from the capacitors to the amplifier reduce the trace inductance. A series inductance with the parallel capacitance can form a tank circuit, which can introduce high frequency ringing at the output. This additional inductance can also contribute to increased distortion due to high frequency compression at the output. The use of vias should be minimized in the direct path to the amplifier power supply pins since vias can introduce parasitic inductance, which can lead to instability. When required, use multiple large diameter vias because this lowers the equivalent parasitic inductance.

GROUNDING

The use of ground and power planes is encouraged as a method of providing low impedance returns for power supply and signal currents. Ground and power planes can also help to reduce stray trace inductance and to provide a low thermal path for the amplifier. Ground and power planes should not be used under any of the pins of the AD8045. The mounting pads and the ground or power planes can form a parasitic capacitance at the amplifiers input. Stray capacitance on the inverting input and the feedback resistor form a pole, which degrades the phase margin, leading to instability. Excessive stray capacitance on the output also forms a pole, which degrades phase margin.

EXPOSED PADDLE

The AD8045 features an exposed paddle, which lowers the thermal resistance by 25% compared to a standard SOIC plastic package. The exposed paddle of the AD8045 is internally connected to the negative power supply pin. Therefore, when laying out the board, the exposed paddle must either be connected to the negative power supply or left floating (electrically isolated). Soldering the exposed paddle to the negative power supply metal ensures maximum thermal transfer. Figure 74 and Figure 75 show the proper layout for connecting the SOIC and LFCSP exposed paddle to the negative supply.

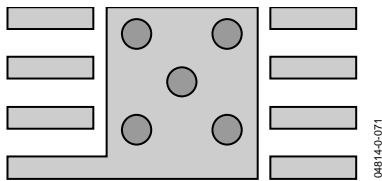

Figure 74. SOIC Exposed Paddle Layout

The use of thermal vias or heat pipes can also be incorporated into the design of the mounting pad for the exposed paddle. These additional vias help to lower the overall theta junction to ambient (θ_{JA}). Using a heavier weight copper on the surface to which the exposed paddle of the amplifier is soldered can greatly reduce the overall thermal resistance seen by the AD8045.

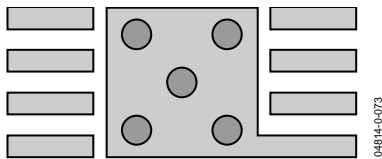

Figure 75. LFCSP Exposed Paddle Layout

For existing designs that want to incorporate the AD8045, electrically isolating the exposed paddle is another option. If the exposed paddle is electrically isolated, the thermal dissipation is primarily through the leads, and the thermal resistance of the package now approaches $125^{\circ}\text{C}/\text{W}$, the standard SOIC θ_{JA} . However, a thermally conductive and electrically isolated pad material may be used. A thermally conductive spacer, such as the Bergquist Company Sil-Pad, is an excellent solution to this problem. Figure 76 shows a typical implementation using thermal pad material.

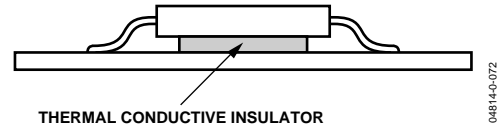

Figure 76. SOIC with Thermal Conductive Pad Material

The thermal pad provides high thermal conductivity but isolates the exposed paddle from ground or other potential. It is recommended, when possible, to solder the paddle to the negative power supply plane or trace for maximum thermal transfer.

Note that soldering the paddle to ground shorts the negative power supply to ground and can cause irreparable damage to the AD8045.

DRIVING CAPACITIVE LOADS

In general, high speed amplifiers have a difficult time driving capacitive loads. This is particularly true in low closed-loop gains, where the phase margin is the lowest. The difficulty arises because the load capacitance, C_L , forms a pole with the output resistance, R_O , of the amplifier. The pole can be described by the equation

$$f_P = \frac{1}{2\pi R_O C_L}$$

If this pole occurs too close to the unity-gain crossover point, the phase margin degrades. This is due to the additional phase loss associated with the pole.

The AD8045 output can drive 18 pF of load capacitance directly, in a gain of +2 with 30% overshoot, as shown in Figure 37. Larger capacitance values can be driven but must use a snubbing resistor (R_{SNUB}) at the output of the amplifier, as shown in Figure 61 and Figure 62. Adding a small series resistor, R_{SNUB} , creates a zero that cancels the pole introduced by the load capacitance. Typical values for R_{SNUB} can range from $25\ \Omega$ to $50\ \Omega$. The value is typically arrived at empirically and based on the circuit requirements.

OUTLINE DIMENSIONS

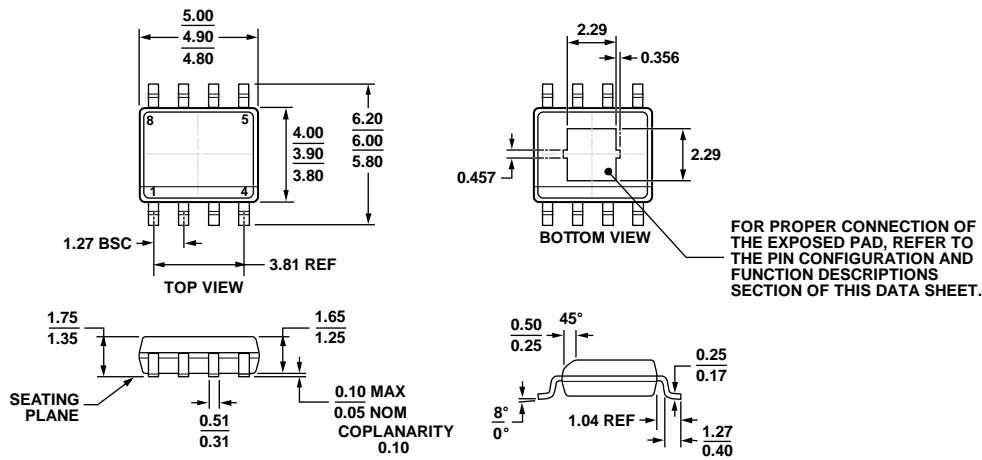

COMPLIANT TO JEDEC STANDARDS MS-012-A A

Figure 77. 8-Lead Standard Small Outline Package with Exposed Pad [SOIC_N_EP] Narrow Body (RD-8-1)
Dimensions shown in millimeters

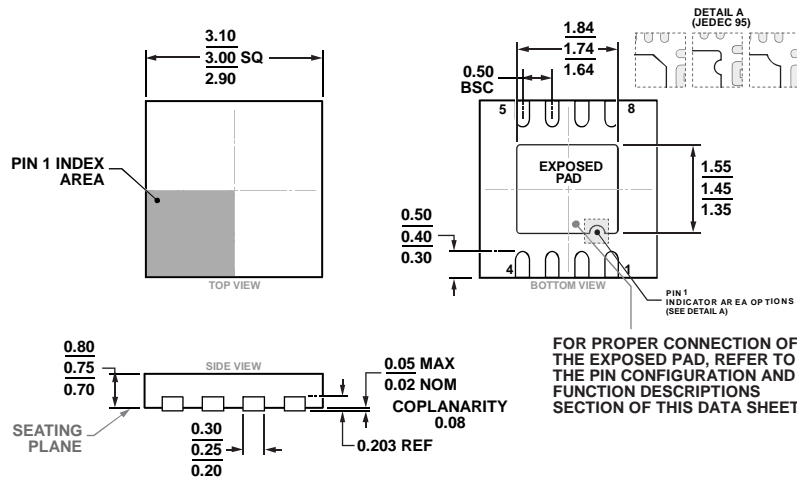

COMPLIANT TO JEDEC STANDARDS MO-229-WEED-4

Figure 78. 8-Lead Lead Frame Chip Scale Package [LFCSPP] 3 mm x 3 mm Body and 0.75 mm Package Height (CP-8-13)
Dimensions shown in millimeters

ORDERING GUIDE

Model ¹	Minimum Ordering Quantity	Temperature Range	Package Description	Package Option	Marking Code
AD8045ARDZ	1	-40°C to +125°C	8-Lead SOIC_N_EP	RD-8-1	
AD8045ARDZ-REEL7	1,000	-40°C to +125°C	8-Lead SOIC_N_EP	RD-8-1	
AD8045ACPZ-R2	250	-40°C to +125°C	8-Lead LFCSPP	CP-8-13	H8B
AD8045ACPZ-REEL7	1,500	-40°C to +125°C	8-Lead LFCSPP	CP-8-13	H8B

¹ Z = RoHS Compliant Part.

Mouser Electronics

Authorized Distributor

Click to View Pricing, Inventory, Delivery & Lifecycle Information:

[Analog Devices Inc.:](#)

[AD8045ARDZ](#) [AD8045ARDZ-REEL7](#) [AD8045ACPZ-REEL7](#) [AD8045ACPZ-R2](#)