



RECOIL®

Technical
Catalogue



Table of Contents

Introduction.....	3
Recoil Range.....	4
How a Recoil Insert Works	5
How a Locking Insert Works	8
Locking Insert Torque Values.....	9
Lubricants and Coatings.....	10
Finishes and Coatings	11
Corrosion Protection.....	12
MS Insert Dimensional Data.....	13
Recoil Metric Insert Part Number Call-Out and Dimensional Data.....	14
Recoil Metric Strip-Feed Insert Part Numbers	22
Recoil Inch Insert Part Number Call-Out and Dimensional Data.....	23
Recoil Strip-Feed Part Number Call-Out and Dimensional Data.....	28
STI Taps	30
Tap Terminology	49
Recoil Tap Part Numbers and Dimensional Data Metric Thread Series	32
Recoil Tap Part Numbers and Dimensional Data Unified Thread Series	33
Recoil Tapped Hole and Fitted Size Data - Metric.....	36
Recoil Tapped Hole and Fitted Size Data - Unified	37
Recoil Tapped Hole and Fitted Size Data - BA.....	38
Recoil Tapped Hole and Fitted Size Data - BSF.....	39
Recoil Tapped Hole and Fitted Size Data - BSP	41
Recoil Tapped Hole and Fitted Size Data - BSW.....	42
Recoil Tapped Hole and Fitted Size Data - 8UN.....	43
Design and Installation Data - NPT	44
Process Sheet - NPT.....	46
Drill, Tapping and Installation Depths.....	48
Tooling.....	50
Recoil Kits / Tool - Metric.....	54
Recoil Kits / Tool - Unified.....	55
Production Installation Tooling.....	58
Electric Mandrel Specifications - Metric.....	59
Electric Mandrel Specifications - Unified	60
Pneumatic Installation Tooling	61
Design Considerations.....	62
Assembly Design	63
Thread Identification and Drill Chart.....	66
General Information.....	67

Introduction

Alcoa Fastening Systems' (AFS) Recoil manufacturing operations are located in Australia, with sales and warehouse facilities strategically located in North America, Asia, and Europe. Extensive worldwide distribution, coupled with the company's manufacturing strategy, offers significant advantages to end users.

Alcoa Fastening Systems ensures a global consistency of quality design standards in manufacturing the full range of wire thread inserts in one production facility. Users around the world can be assured of high standards and the consistency of all AFS products.

Inserts are manufactured in standard sizes for all metric and inch thread forms. A comprehensive design facility is available to ensure that non-standard inserts can be manufactured for special part requirements.

Prompt availability of products to customers worldwide is ensured by an efficient international freight service and a network of stocking distributors. Alcoa Fastening Systems is committed to the highest quality products and operating systems and employs a strict quality management system in accordance with:

- AS9100 accreditation
- ISO9001 accreditation
- TS16949 accreditation
- Society of British Aerospace Companies (SBAC)
- TS157 approval
- ISO14001 Environmental Systems

Alcoa Fastening Systems will provide technical assistance to production engineers so that optimum installation efficiency can be achieved and maintained. Recoil brand coils are available to the following international and customer standards:

- NASM122076 Series - Free Running - UNC
- NASM124651 Series - Free Running - UNF
- NASM21209 Series – Locking UNC and UNF
- NASM8846
- BS7751 - Metric - Coarse
- BS7752 - Metric - Fine
- BS7753
- BS4377
- MA3279, MA3280, MA3281 - Metric - Free Running
- MA3329, MA3330, MA3331 - Metric - Self Locking
- AS6733 Series - UNF - Unplated
- AS8455 Series - UNF - Cadmium Plated
- AGS3600 Series - UNF - Cad. Plated - Self Locking
- AGS3700 Series - Nimonic Alloy 90 - Self Locking
- General Electric - C981, N926 Series
- LN9499, LN9039
- DIN8140
- BACI12AE - Boeing

Recoil Range

The Recoil system consists of precision inserts, quality high speed taps, and easy-to-use installation tools which are used for repairing damaged screw threads or creating strong new threads. Recoil helically wound screw-thread inserts are generally manufactured from Type 304 (18-8) stainless steel wire cold rolled into a diamond shaped cross section. Recoil inserts can be supplied in other materials such as Inconel X750, Inconel 625, Nimonic 90, Nitronic 60, Phosphor Bronze and Type 316 stainless steel.

Recoil inserts are available in either standard free running form or screw lock type which provides an internal locking feature. Inserts are manufactured for every thread form including UNC, UNF, BSC, BSW, BSP, BSF, BA, NPT and ISO Metric thread sizes. Inserts are available in 5 different standard lengths. 1D, 1.5D, 2D, 2.5D and 3D. Special lengths are available on request.

Thread Repair Kits

A full range of Recoil thread repair kits, covering the majority of sizes commonly in use today, is available from AFS. Recoil kits contain an HSS tap, installation tools, tang break tools, drills, stainless steel inserts, and instructions, in a sturdy reusable container. Recoil problem-solving repair kits are available in single or multiple size format.

Installation Tooling

Alcoa Fastening Systems also offers a selection of work arms and power tooling, including high efficiency pneumatic and electric installation tools for in-line production or repetitive maintenance situations. A range of associated tooling is available to facilitate insert installation, including manual installation tooling and manual, spring, and pneumatic operated tang breakoff tools.

Taps and Gauges

Optimum results can be achieved with Recoil taps and gauges to suit hand-tapping through to volume production requirements. Using the "Go - NoGo" gauge, tapped holes can be gauged to enable a precision fit.



How a Recoil Insert Works

Recoil inserts are formed from high quality stainless steel wire with a diamond shaped cross section, wound to the shape of a spring thread. Once the wire is wound into a helical coil and installed into a tapped hole, it provides a permanent and wear resistant thread in the parent material that is generally stronger than the original thread. The inserts are designed to be greater in diameter than the tapped hole and compress as they are installed. This allows maximum surface contact area with the tapped thread, safely and permanently anchoring the inserts into place. The insert's compensatory action shares the load over the entire bolt and hole, increasing pull out and torque out strength. With a Recoil insert in place, load and stress are more evenly distributed over the assembly.

Where to Use Recoil Inserts

Original Equipment Manufacture

AFS offers innovative manufacturers the opportunity to design high quality product using lighter weight materials such as aluminum and magnesium alloys while still achieving high strength and reliability in the threaded fastener assembly. Recoil brand inserts are widely used by manufacturers in:

- Automotive
- Consumer Electronics
- Ship Building
- Power Generation
- Manufacturing Equipment
- Industrial Electronics
- Aerospace – Avionics, Engines, Airframe
- Defense
- Transport

Repair

When you encounter a damaged thread Recoil offers:

- Quickest and simplest method of repair to stripped or damaged threads
- A superior thread with great holding power
- Most cost-effective method of repair
- Returns thread to the original size
- Generally stronger than the original female thread

Insert Material

Recoil inserts are generally manufactured from Type 304 stainless steel (18-8), however inserts are available in a range of materials for special applications:

- Stainless Steel Grade 304 (AS7245) Austenitic Corrosion Resistant Steel For normal applications up to 425°C (800°F)
- Stainless Steel Grade 316 (AISI316) Austenitic Corrosion Resistant Steel For Marine applications up to 425°C (800°F)
- Inconel X - 750 (AS7246) Nickel Alloy. For high temperature applications 425°C - 550°C (800°F - 1020°F) or where low permeability is required.
- Phosphor Bronze (DIN17677 or BS2783 PB 102) (300°C) For electrical bonding joints or low permeability
- Nimonic 90 (HR 503) for high temperature applications. (650°C/1200°F)
- Nitronic 60 (UNS S21800) Austenitic antigalling alloy

Special purpose

- Materials such as Inconel 625 and Spring Steel Grade are also available to special order

Type

There are two basic types of Recoil inserts available:

- Free running inserts which provide a standard female thread
- Locking inserts which provide a locking function for the female thread when the fasteners installed



How a Recoil Insert Works

Insert installation and retention

Uninstalled, Recoil inserts are greater in diameter than the tapped hole in the parent material into which they are to be installed. During the assembly operation the diameter of the leading coil is reduced thereby permitting entry of the insert into the tapped hole. When the insert is installed at the correct depth, the coils expand and permanently retains the insert in place. Unlike many 'solid' insert types, it is not necessary to use locking, swaging or keying operations to locate and retain Recoil inserts. Stress concentration problems which typically occur in the parent material when using solid inserts are therefore eliminated. A Recoil insert will dimensionally adjust both radially and axially, to any expansion or contraction within the parent material.

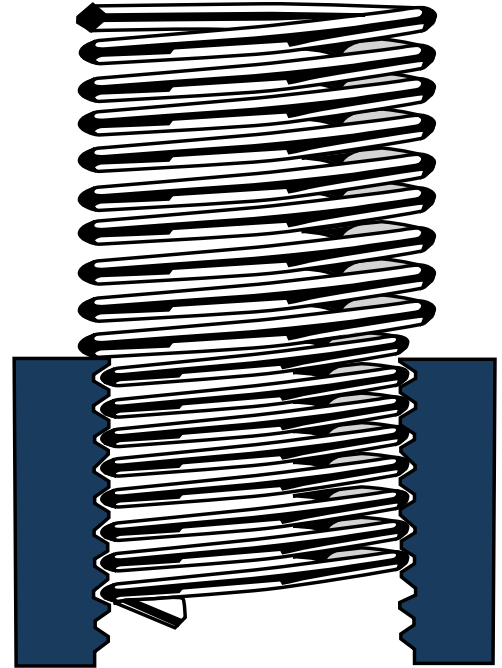

Recoil insert in semi-installed position

Typical thread and angle errors may cause:

- Limited contact point
- Poor flank contact between bolt to parent thread
- Unequal distribution of bolt load over engaged threads
- Failure of threaded components when loaded

Recoil inserts reduce thread pitch and angle errors to provide:

- Greater fastener strength
- Greater contact area
- Equally distributed load over all tapped threads
- Reduced stress concentration thereby extending fatigue life



Angle error



Pitch error

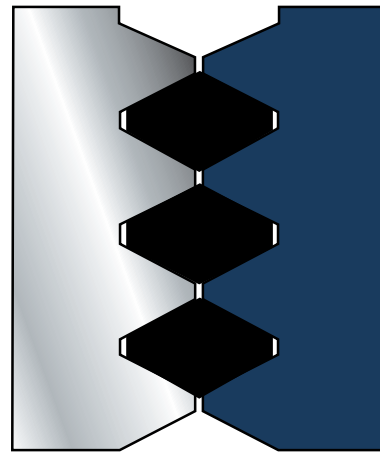

Recoil compensation effect

Recoil inserts are installed in four easy steps...

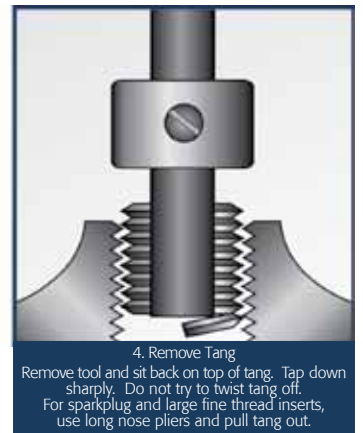
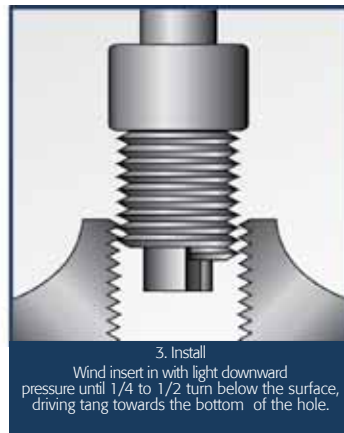
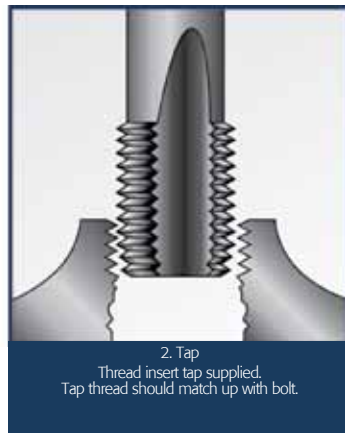
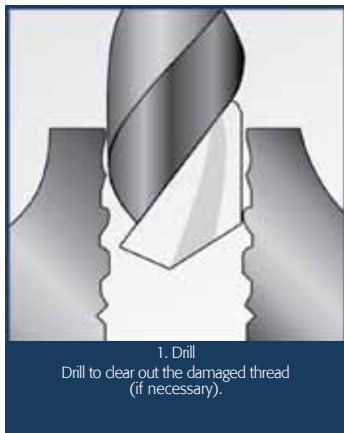

How a Recoil Insert Works

The diagram below depicts graphically the advantages a Recoil insert has over a conventional thread. In conventional threaded joints over 75% of the load is placed on the first three threads of the assembly. The Recoil insert on the left shows how the spring-like design of the insert allows the shear loading to be transformed into a preferable "hoop stress" or radial loading over the entire length of the insert. This provides a much stronger thread than can be obtained by conventional drilling or tapping.

This improved strength allows designers to select a fastener based on the minimum strength of the bolt, also allowing them to select smaller diameters and shorter thread lengths confidently even in low strength materials such as magnesium or aluminium alloys. (Refer to page 62 - Design Considerations)

Bolt with Recoil Insert

Standard Bolt in Material

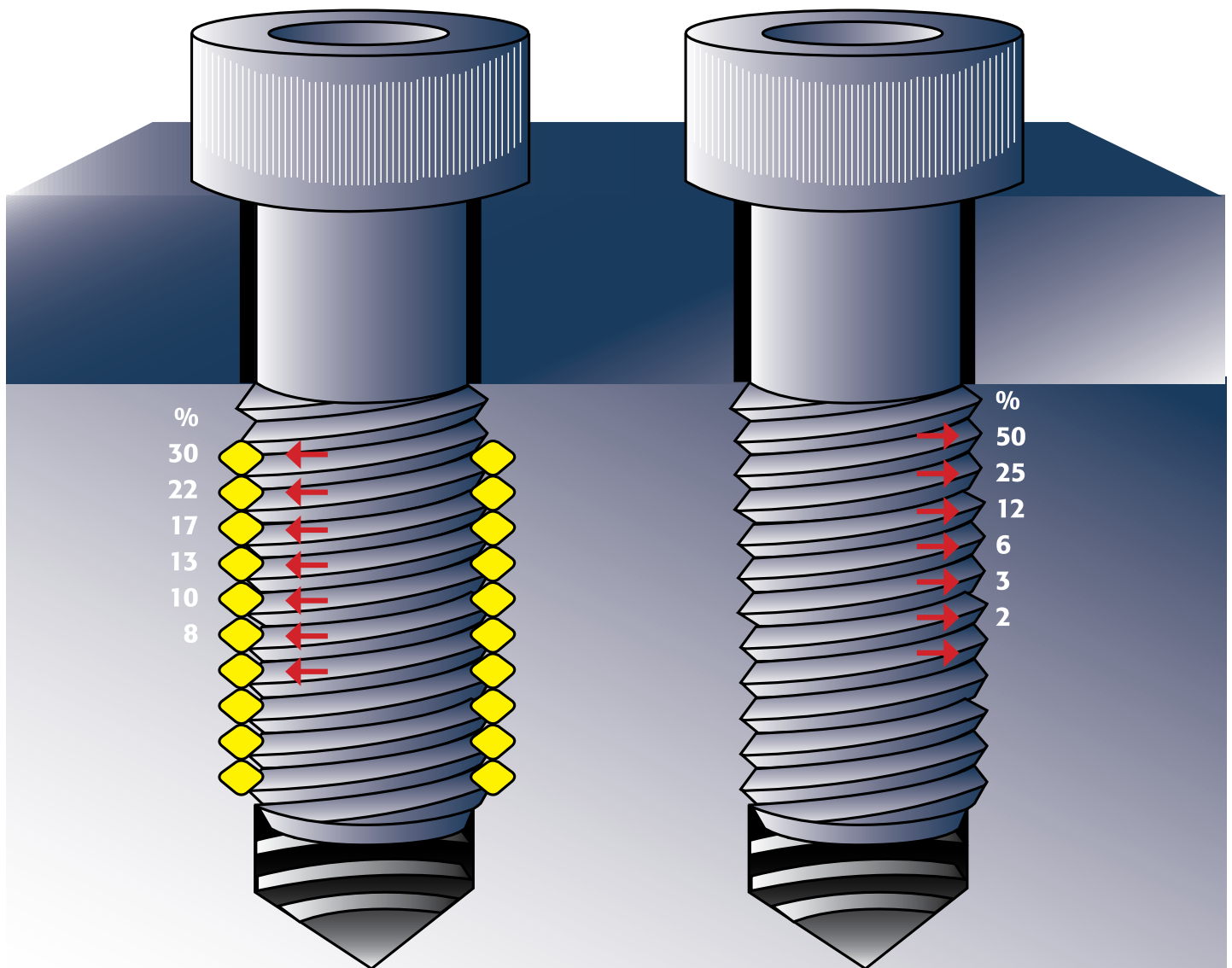

High strength
stress spread more evenly

Lower strength
stress concentrated on first threads

How a Locking Insert Works

The Recoil screw-locking insert is designed to provide a screw-locking feature which will retain screws or bolts under the most severe vibration or varying temperature conditions. The insert locking configuration comprises a series of uniquely designed locking chords which, upon the engagement of a screw or bolt, deflect radially to permit the installation of the bolt. Upon bolt entry, these straight segments are flexed outwardly, creating pressure on the bolt. This pressure is applied between the flanks of the bolt thread so that contact area is maximized. Locking inserts retain locking torque over numerous assembly cycles. Refer to relevant specifications for insert life. Each Recoil screw-locking insert type has a specifically designed locking configuration. This ensures that the insert meets its design specification requirements. Therefore the shape, depth, and number of locking chords will inevitably vary for differing thread types and sizes.

Note: It is recommended that a cadmium plated or dry-film lubricated screw/bolt is used for screw-locking inserts applications. (See Lubricants and Coatings page)

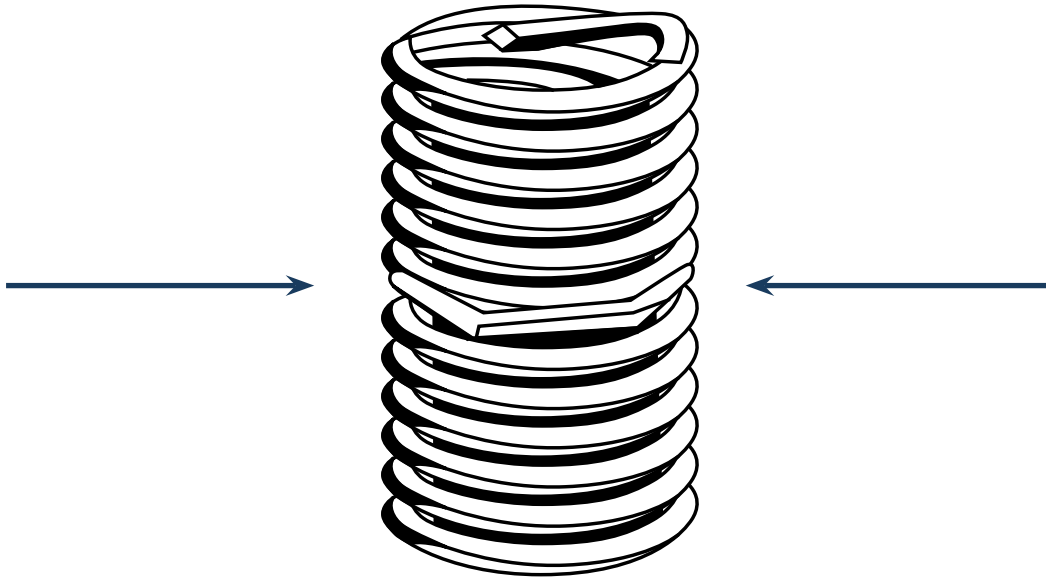

Locking Insert Design

Should a specific locking torque or function be required, AFS engineers can develop parts to suit customers' needs. As the bolt is wound through the locking chords of the insert it deflects the wire as shown by the internal arrows (A). This deflection causes the insert to push against the bolt resulting in a repeatable locking function from the insert.

Note: Installation of Recoil screw-locking inserts requires use of the Recoil Prewinder tooling.

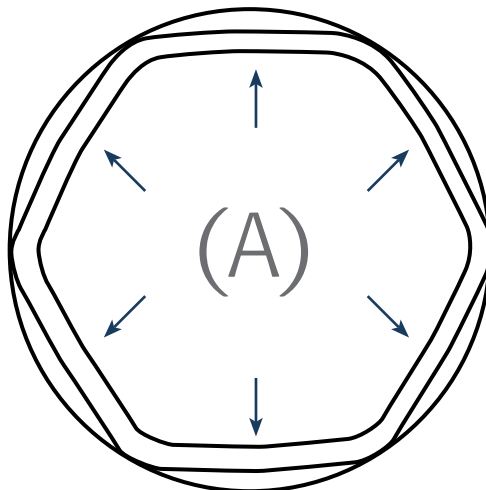

Locking Insert Torque Values

Locking torque values for unified inserts conform to NASM8846. Locking torque values for metric Recoil inserts conform to MA3329, MA3330 and MA3331.

Unified Coarse (UNC)		
Nominal Thread Size	Max Locking Torque	Min Locking Torque
2 (.086") - 56	20 oz.in	3 oz.in
3 (.099") - 48	32 oz.in	7 oz.in
4 (112") - 40	48 oz.in	10 oz.in
5 (.125") - 40	75 oz.in	13 oz.in
6 (.138") - 32	6 lb.in	1.0 lb.in
8 (.164") - 32	9 lb.in	1.5 lb.in
10 (.190") - 24	13 lb.in	2.0 lb.in
12 (.216") - 24	24 lb.in	3.0 lb.in
1/4 (.250") - 20	30 lb.in	4.5 lb.in
5/16 (.3125") - 18	60 lb.in	7.5 lb.in
3/8 (.3750") - 18	80 lb.in	12.0 lb.in
7/16 (.4375") - 14	100 lb.in	16.5 lb.in
1/2 (.5000") - 13	150 lb.in	24.0 lb.in
9/16 (.5625") - 12	200 lb.in	30.0 lb.in
5/8 (.6250") - 11	300 lb.in	40.0 lb.in
3/4 (.7500") - 10	400 lb.in	60.0 lb.in
7/8 (.8750") - 9	600 lb.in	82.0 lb.in
1 (1.000") - 8	800 lb.in	110.0 lb.in
11/8 (1.1250") - 7	900 lb.in	137.0 lb.in
11/4 (1.250") - 7	1000 lb.in	165.0 lb.in
13/8 (1.3750") - 6	1150 lb.in	185.0 lb.in
11/2 (1.5000") - 6	1350 lb.in	210.0 lb.in

Unified Fine (UNF)		
Nominal Thread Size	Max Locking Torque	Min Locking Torque
3 (.099) - 56	32 oz.in	7oz.in
4 (.112) - 48	48 oz.in	10 oz.in
6 (.138) - 40	6 lb.in	1.0 lb.in
8 (.164) - 36	9 lb.in	1.5 lb.in
10 (.190) - 32	13lb.in	2.0 lb.in
1/4 (.2500) - 28	30 lb.in	3.5 lb.in
5/16 (.3125) - 24	60 lb.in	6.5 lb.in
3/8 (.3750) - 24	80 lb.in	9.5 lb.in
7/16 (.4375) - 20	100 lb.in	14.0 lb.in
1/2 (.5000) - 20	150 lb.in	18.0 lb.in
9/16 (.5625) - 18	200 lb.in	24.0 lb.in
5/8 (.6250) - 18	300 lb.in	32.0 lb.in
3/4 (.7500) - 16	400 lb.in	50.0 lb.in
7/8 (.8750) - 14	600 lb.in	70.0 lb.in
1 (1.0000) - 12	800 lb.in	90.0 lb.in
11/8 (1.1250) - 12	900 lb.in	117.0 lb.in
11/4 (1.2500) - 12	1000 lb.in	143.0 lb.in
13/8 (1.3750) - 12	1150 lb.in	165.0 lb.in
11/2 (1.5000) - 12	1350 lb.in	190.0 lb.in

Metric Coarse Series		
Nominal Thread Size	Max Locking Torque	Min Locking Torque
M2.2 x 0.45	0.14 Nm	0.02 Nm
M2.5 x 0.45	0.23 Nm	0.05 Nm
M3 x 0.5	0.45 Nm	0.1 Nm
M3.5 x 0.6	0.68 Nm	0.12 Nm
M4 x 0.7	0.9 Nm	0.15 Nm
M5 x 0.8	1.6 Nm	0.3 Nm
M6 x 1	3 Nm	0.4 Nm
M7 x 1	4.5 Nm	0.6 Nm
M8 x 1.25	6 Nm	0.8 Nm
M10 x 1.5	10.5 Nm	1.4 Nm
M12 x 1.75	15.5 Nm	2.1Nm
M14 x 2	23.5 Nm	3 Nm
M16 x 2	31.5 Nm	4.2 Nm
M18 x 2.5	42 Nm	5.5 Nm
M20 x 2.5	54 Nm	7 Nm
M22 x 2.5	67.5 Nm	9 Nm
M24 x 3	80 Nm	10.5 Nm
M27 x 3	94 Nm	12 Nm
M30 x 3.5	108 Nm	14 Nm
M33 x 3.5	122 Nm	15.5 Nm
M36 x 4	136 Nm	17.5 Nm
M39 x 4	150 Nm	19.5 Nm

Metric Fine Series		
Nominal Thread Size	Max Locking Torque	Min Locking Torque
M8 x 1	6 Nm	0.8 Nm
M10 x 1	10.5 Nm	1.4 Nm
M10 x 1.25	10.5 Nm	1.4 Nm
M12 x 1.25	15.5 Nm	2.1 Nm
M12 x 1.5	15.5 Nm	2.1 Nm
M14 x 1.5	23.5 Nm	3 Nm
M16 x 1.5	31.5 Nm	4.2 Nm
M18 x 1.5	42 Nm	5.5 Nm
M20 x 1.5	54 Nm	7 Nm
M22 x 1.5	67.5 Nm	9 Nm
M18 x 2	42 Nm	5.5 Nm
M20 x 2	54 Nm	7 Nm
M22 x 2	67.5 Nm	9 Nm
M24 x 2	80 Nm	10.5 Nm
M27 x 2	94 Nm	12 Nm
M30 x 2	108 Nm	14 Nm
M33 x 2	122 Nm	15.5 Nm
M36 x 2	136 Nm	17.5 Nm
M39 x 2	150 Nm	19.5 Nm
M36 x 3	136 Nm	17.5 Nm
M39 x 3	150 Nm	19.5 Nm

Note: Unplated, heat-treated screws or stainless steel screws should not be used with screw-lock inserts. An antiseize compound (Molybdenum Disulphide, etc) should be applied to the screw to minimize galling and achieve maximum cycle life. Also available are inserts plated with cadmium per QQ-P-416, Type II, or dry film lubricant per MIL-L-46010 (no graphite) which improves wear life of the screw and insert. Note: It is imperative that the bolts fully engage all locking coils for correct torque and all insert coils for maximum strength.

Lubricants and Coatings

It is important that correct selection of the most suitable fastening lubricant or coating is made at the design stage for long term security within the bolted joint. The ideal finish or coating for the insert is dependent upon the optimum coefficient of friction (governed by the bolt material and surface finish) and the required service conditions of the assembled parts, e.g. temperature, chemical influences, humidity, and dust. The coefficient of friction (μ) of most threaded components will generally vary between $\mu = 0.15$ and $\mu = 0.35$. For example differences occur between bolts made of Grade 8.8 steel (Werkstoff 1.0503), compared with the same size of bolt produced from an austenitic stainless steel X5 CrNi 18-9, (Werkstoff 1.4301). Differences also occur between bolts having different surface coatings, such as electro-galvanizing, hot galvanizing, cadmium plating, or chromium plating.

Typical Recoil wire thread insert finishes and coatings

PLATING / FINISH	PART NUMBER SUFFIX	APPLICABLE PROCESS SPECIFICATION
Silver Plating	AG	DTD 939
Cadmium Plating	C	QQP-416 or DEF STD 03-19
Dry Film Lubricant	D	AS5272
Red Dye	Not Applicable	Applied to all Recoil locking inserts for identification where called for by specification*
Tin Plating	SN	identification where called for by specification*
Copper	Cu	identification where called for by specification*

* Recoil inserts may also be dyed in other colors such as Green and Blue for identification purposes.

MATERIAL TYPE	MAX. TEMPERATURE		TYPICAL APPLICATIONS (SEE SECTION ON LUBRICANTS)	COATINGS
	PEAK	CONTINUOUS		
Stainless 304	425°C (800°F)	315°C (600°F)	Most general applications in all materials	Non-finished Dry film lubricant Silver Cadmium
Stainless 316	425°C (800°F)	315°C (600°F)	Improved corrosion resistance Salt water applications	Non-finished Dry film Lubricant Silver Cadmium
Nitronic 60	425°C (800°F)	315°C (600°F)	Anti-galling	Dry film lubricant
Phosphor Bronze	300°C (572°F)	235°C (455°F)	Copper parts Non magnetic / Low permeability applications	Cadmium Silver
Inconel x 750	650°C (1200°F)	550°C (1020°F)	Aerospace / Turbines / Corrosive atmospheres / High temperature use	Silver Copper
Nimonic 90	650°C (1200°F)	550°C (1020°F)	Aerospace / Turbine applications	Silver

Phosphor Bronze

Designed for electrical applications, Recoil Phosphor Bronze inserts provide no outside interference of signals. This characteristic ensures their successful use in electrical bonding joints and related operations. These advanced inserts have been successfully employed in the manufacturing of a wide range of sensitive electrical equipment including circuit boards, telecommunications control boxes, and medical instrumentation and equipment.



Inconel

Inconel X-750 is an alloy material with excellent high heat resistance and strength characteristics. Used in demanding applications like gas turbines and auto lambda sensor repairs, these inserts can withstand temperatures of 1020°F and can be certified to GE Power Generation standards. Inconel X-625 material possesses very high corrosion resistance and is used in sub-sea platforms and other critical salt water and marine applications.



316 Stainless

Often used in highly corrosive applications, Recoil 316 Stainless Steel inserts provide a high degree of reliable corrosion resistance. In freshwater, saltwater, even chlorine environments, the inserts are designed to deliver years of failure-proof threadholding performance.



Nitronic 60 Inserts

Designed for applications where galling can be a problem, Recoil Nitronic 60 inserts' wear-resistant, anti-galling characteristics eliminate the need for additional lubrication. Based on the reduction in friction they provide, these inserts deliver more consistent clamping torque. In addition, Nitronic 60 inserts are suitable for use with stainless steel screws.



Finishes and Coatings

Silver Plating (AG)

Primarily used to reduce the effects of galling (seizure) of screw threads in high temperature service applications. Silver plating is the most commonly used coating for aero-engine fasteners providing an even degree of lubrication up to a maximum service temperature of about 650°C (1200°F). The plated silver is electrolytically deposited in typical thicknesses up to 6.3µm (0.00025"). Silver plated wire thread inserts may be installed into various housing materials including magnesium alloys, aluminum alloys, corrosion and heat resistant materials, etc.

Caution must be emphasized where inserts are to be installed into titanium alloy components which may exceed a service temperature of 300°C (570°F). Silver plated inserts are not recommended with titanium housings as stress corrosion, resulting from the combination of silver with titanium may occur in the housing material.

Cadmium Plating (C)

In mildly corrosive or marine environments, cadmium plating is the preferred treatment for providing protection against pitting of the insert/bolt materials and to minimize the risk of thread seizure. Plating thickness may vary depending on particular applications, between 2µm - 5µm (0.0001" - 0.0002"). Following cadmium plating, either a bronze or olive drab chromate finish will be used to provide uniformity in the overall finish. It should be noted that cadmium plated parts must not:

- Be subjected to temperatures exceeding 235°C (455°F)
- Come into contact with fuel or hot oil
- Come into contact with food or drinking water
- Be used with titanium components either directly or indirectly as, at elevated temperatures, embrittlement and subsequent component failure may occur

Warning: Cadmium is a highly toxic compound. Because of its poisonous nature extreme care must be taken when handling.

Dry Film Lubricants (D)

Used for mildly corrosive or high temperature applications, dry film lubricants comprise suspensions of small particles of solid lubricants such as molybdenum disulphide (MoS₂) or PTFE, in organic or inorganic binders. They are applied as a thin film (5µm - 20µm) to grease-free metal surfaces. Through careful selection of appropriate additives and solvents, specific lubricants may be formulated to suit most industrial applications to service temperatures around 315°C (600°F). Special high temperature lubricant coatings are available for use up to 425°C (800°F). Recoil inserts may be coated with dry film lubricant in either the non-finished (passivated) condition or after cadmium plating treatment for maximum corrosion protection.

Tin Plating (SN)

As per ISO2093, used for moderate corrosive condition typically in automotive applications

Red Dye Coating

Recoil screw-locking inserts are, generally color coded with a red dye coating for identification purposes only. This organic resin based dye does not affect the installation or function of the inserts and normally does not need to be removed. However, if in extreme conditions of cleanliness (such as precision instrument assembly in clean room conditions) removal of the dye may be desired. The red dye may be removed by soaking the inserts in a denatured alcohol solution prior to use. To prevent galling or seizing when using an unplated or corrosion resistant screw/bolt in a screw-locking insert, we recommend the use of an anti-seize compound on the bolt threads.

Corrosion Protection

Under some service conditions, Recoil inserts and their mating parts may be subjected to a degree of corrosion, the severity of which is dependent upon the particular application. Factors such as differing material types, atmospheric conditions, chemical attack, and even frequency of use will have an appreciable effect on the longevity of the bolted joint.

The following are recommendations to minimize corrosion within the bolted Recoil insert assemblies. Normal Service: Natural atmospheric environment with the screw/bolt permanently installed into the insert not adjacent to salt water.

Normal Service:

Natural atmospheric environment with the screw/bolt permanently installed into the insert not adjacent to salt water.

Severe Service:

Mildly contaminated atmospheric environments involving moisture, occasional exposure to a chloride air or sea spray, and where the screw/bolt may be removed from the insert for extended periods of time.

Extreme Severe Service:

Assembly is exposed to salt water, corrosive atmosphere, high temperature, or the screw/bolt is frequently removed from the assembly, allowing the ingress of water into a blind hole. In addition to methods 1, 2 and 3 below, further corrosion protection can be achieved by:

- Using blind holes wherever possible
- Using a sealing, insulating, or step-down type washer under the head of the bolt
- Using bolts that extend completely through the entire length of the insert
- In critical applications, the use of a non-hardening seal or compound over the joint and protecting bolt thread is recommended

Note - For extremely severe service conditions involving temperatures in excess of 425°C (800°F) or contact with acids, alkalis or sea water, stainless steel inserts are not recommended.

Gas and Water Applications

Where gas or water threads are being manufactured or repaired it is important that an AFS sales office be consulted regarding the type of seal that will be provided in this situation. A wire insert may not provide a satisfactory thread seal.

PARENT MATERIAL	SERVICE CONDITIONS		
	NORMAL	SEVERE	EXTREME SEVERE
Aluminum	None	Methods 2 or 3	Methods 1, 2 & 3
Magnesium	Methods 2 or 3	Methods 2 and 3	Methods 1, 2 & 3

METHOD 1	TYPICAL CORROSION RECOMMENDATIONS	
	METHOD 2	METHOD 3
Parent Material Protection Aluminum: For oxide coating use Alodine, Anodize, Iridite, or similar. Iridite 14 or 14-2 (MIL-C-554) is recommended for critical parts rather than anodizing (MIL-S-5002)	Coat the insert with one of the following: Cadmium per QQ-P-416, Type II 0.0001" thick; or Dry Film Lubricant per MIL-L-893 (must be free of graphite)	Separate the parent material from the insert by using liquid zinc chromate primer, Federal Specification TT-P-1757. Apply the primer to the hole sparingly and install while the primer is still wet.

MS Insert Dimensional Data

Drawing Call-Out

An example of a typical drawing specification for a Recoil insert is shown below:

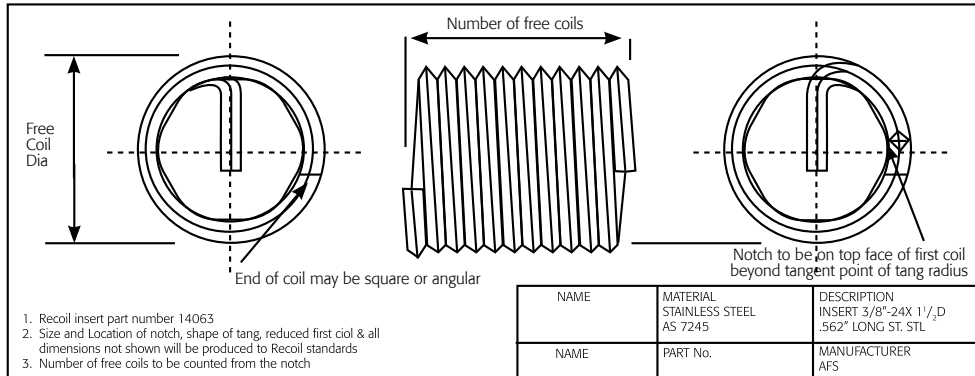

A typical drawing call-out for a Recoil screw-locking insert 3/8" - 24 x 1 1/2 dia. long Class 3B Unified Fine Thread (UNF) is shown. Drawing call-outs can be simply defined by using a production sequence process sheet to provide the operational steps with the drawing showing dimensional limits and data. (Example shown below)

- 1) Drill hole 25/64" (.3906") diameter, depth .812" plus your normal standard for drilling depth.
- 2) Countersink 120° +/-5° .42"/.45" diameter.
- 3) Tap with Recoil STI Tap No. 44065 (class 3B) full thread depth .600".
- 4) Gauge with Recoil Gauge No. 64063 or according to your inspection requirements.
- 5) Install Recoil screw-lock insert 14063 with Recoil Inserting Tool No. 54061.
- 6) Break off driving tang with Recoil Tang Break-off Tool No. 59280M.

Recoil Thread Insert Part Numbering System

Recoil insert product part numbering system uses a logically structured 5 digit basic part number. Suffixes are typically added to differentiate between special or non-standard features. This guide defines the structure of Recoil part numbers and may be used for reference to identify a Recoil insert from its part number.

Diagram of Recoil Insert Part Number Example

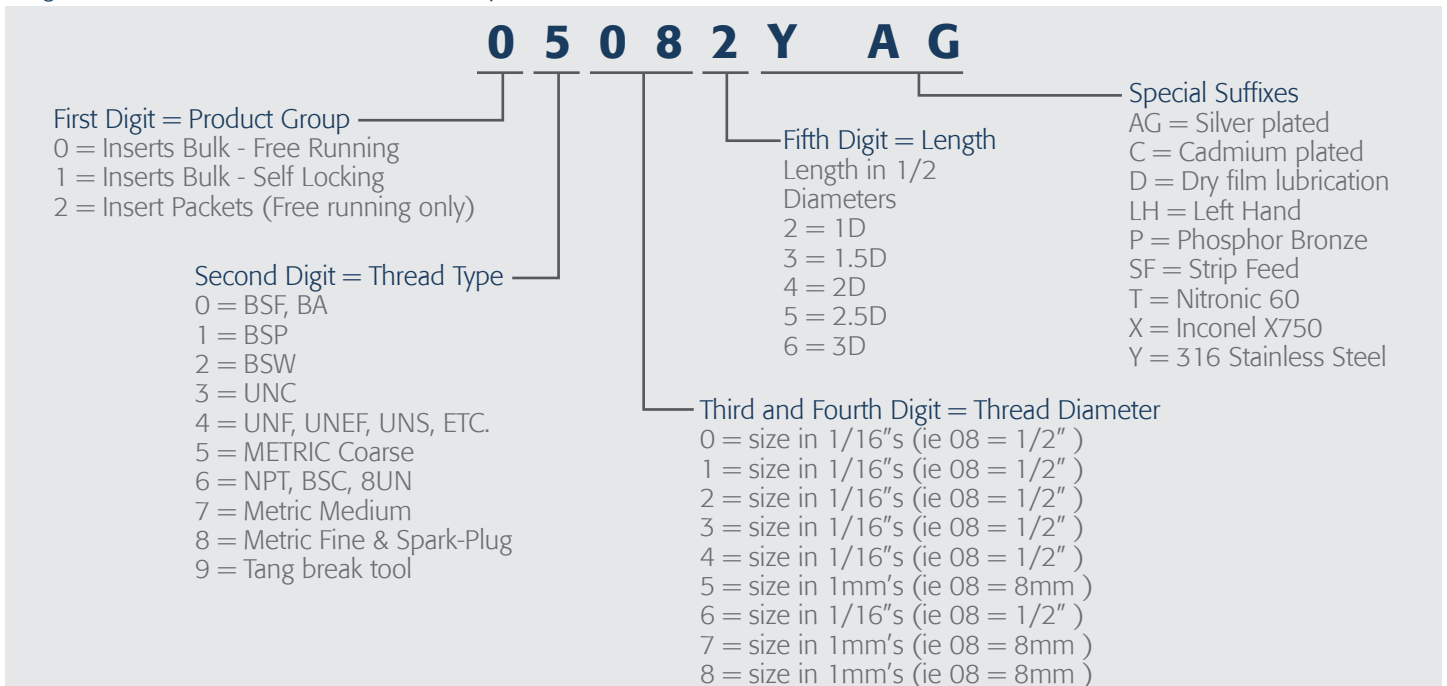

Example - O5082-YAG = M8 - 1.25 x1D 316SS, silver plated insert

Recoil Metric Insert Part Number Call-Out and Dimensional Data

Thread Nominal	Recoil Spec - Free Running Free				Recoil Spec - Screw Locking Free			MA Spec		BASIC LENGTH OF INSERT NOMINAL DIAMETER OF SCREW "D"							
	Nominal Length	Part Number	Coil Dia Min./Max.	Number of Coils	Part Number	Coil Dia Min./Max.	Number of Coils	Free Running Part Number	Screw Locking Part Number	Insert Length inch	mm	Number of Coils	Free Coil Dia Min./Max.	Q	R	S	T
M2 x 0.4	1							05022		0.079	2.0			2.00	1.60	3.80	3.40
	1.5							05023		0.118	3.0	5.5	2.5	3.00	2.60	4.80	4.40
	2							05024	Upon Request	0.157	4.0	7.75	2.7	4.00	3.60	5.80	5.40
	2.5							05025		0.197	5.0	10.125		5.00	4.60	6.80	6.40
	3							05026		0.236	6.0	12.375		6.00	5.60	7.80	7.40
M2.2 x 0.45	1	05012			15012		3.0	05012MA	15012MA	0.087	2.2	3.125		2.20	1.75	4.23	3.98
	1.5	05013			15013	2.8	5.25	05013MA	15013MA	0.13	3.3	5.375	2.80	3.30	2.85	5.33	4.88
	2	05014			15014	2.95	7.55	05014MA	15014MA	0.173	4.4	7.625	3.00	4.40	3.95	6.43	5.98
	2.5	05015			15015		9.75	05015MA	15015MA	0.217	5.5	9.875		5.50	5.05	7.53	7.08
	3	05016			15016		12.0	05016MA	15016MA	0.26	6.6	12.125		6.60	6.15	8.63	8.18
M2.5 x 0.45	1	05252		3.40	15252		3.2	05252MA	15252MA	0.098	2.5	3.375		2.50	2.05	4.53	4.08
	1.5	05253	3.10	6.20	15253	3.25	5.6	05253MA	15253MA	0.15	3.8	5.750	3.20	3.75	3.30	5.78	5.33
	2	05254	3.20	8.95	15254	3.45	8.0	05254MA	15254MA	0.197	5.0	8.125	3.70	5.00	4.55	7.03	6.58
	2.5	05255		11.45	15255		10.35	05255MA	15255MA	0.248	6.3	10.500		6.25	5.80	8.28	7.83
	3	05256		14.05	15256		12.6	05256MA	15256MA	0.295	7.5	12.750		7.50	7.05	9.53	9.08
M3 x 0.5	1	05032			15032		3.6	05032MA	15032MA	0.118	3.0	3.750		3.00	2.50	5.25	4.75
	1.5	05033	3.65	6.95	15033	3.80	6.22	05033MA	15033MA	0.177	4.5	6.375	3.80	4.50	4.00	6.75	6.25
	2	05034	3.80	9.75	15034	3.95	8.73	05034MA	15034MA	0.236	6.0	8.875	4.35	6.00	5.50	8.25	7.75
	2.5	05035		12.55	15035		11.22	05035MA	15035MA	0.295	7.5	11.375		7.50	7.00	9.75	9.25
	3	05036		15.35	15036		13.72	05036MA	15036MA	0.354	9.0	13.875		9.00	8.50	11.25	10.75
M3.5 x 0.6	1	05352		4.00	15352		3.6	05352MA	15352MA	0.138	3.5	3.750		3.50	2.90	6.20	5.60
	1.5	05353	4.30	6.75	15353	4.40	6.23	05353MA	15353MA	0.209	5.3	6.375	4.40	5.25	4.65	7.95	7.35
	2	05354	4.46	9.45	15354	4.55	8.6	05354MA	15354MA	0.276	7.0	8.625	4.95	7.00	6.40	9.70	9.10
	2.5	05355		12.15	15355		11.23	05355MA	15355MA	0.346	8.8	11.375		8.75	8.15	11.45	10.85
	3	05356		14.85	15356		13.6	05356MA	15356MA	0.413	10.5	13.625		10.50	9.90	13.20	12.60
M4 x 0.7	1	05042		3.85	15042			05042MA	15042MA	0.157	4.0	3.625		4.00	3.30	7.15	6.45
	1.5	05043	4.90	6.55	15043			05043MA	15043MA	0.236	6.0	6.125	5.05	6.00	5.30	9.15	8.45
	2	05044	5.15	9.15	15044			05044MA	15044MA	0.315	8.0	8.625	5.60	8.00	7.30	11.15	10.45
	2.5	05045		11.85	15045			05045MA	15045MA	0.394	10.0	11.125		10.00	9.30	13.15	12.45
	3	05046		14.45	15046			05046MA	15046MA	0.472	12.0	13.625		12.00	11.30	15.15	14.45
M5 x 0.8	1	05052		4.45	15052			05052MA	15052MA	0.197	5.0	4.125		5.00	4.20	8.60	7.80
	1.5	05053	6.00	7.35	15053			05053MA	15053MA	0.295	7.5	6.875	6.25	7.50	6.70	11.10	10.30
	2	05054	6.20	10.25	15054			05054MA	15054MA	0.394	10.0	9.625	6.80	10.00	9.20	13.60	12.80
	2.5	05055		13.15	15055			05055MA	15055MA	0.492	12.5	12.375		12.50	11.70	16.10	15.30
	3	05056		16.05	15056			05056MA	15056MA	0.591	15.0	15.125		15.00	14.20	18.60	17.80
M6 x 1	1	05062		4.15	15062			05062MA	15062MA	0.236	6.0	4.000		6.00	5.00	10.50	9.50
	1.5	05063	7.25	6.95	15063			05063MA	15063MA	0.354	9.0	6.750	7.40	9.00	8.00	13.50	12.50
	2	05064	7.45	9.75	15064			05064MA	15064MA	0.472	12.0	9.500	7.95	12.00	11.00	16.50	15.50
	2.5	05065		12.55	15065			05065MA	15065MA	0.591	15.0	12.125		15.00	14.00	19.50	18.50
	3	05066		15.35	15066			05066MA	15066MA	0.709	18.0	14.875		18.00	17.00	22.50	21.50
M7 x 1	1	05072		5.15	15072			05072MA	15072MA	0.276	7.0	4.875	8.65	7.00	6.00	11.50	10.50
	1.5	05073	8.35	8.45	15073			05073MA	15073MA	0.413	10.5	8.000	9.20	10.50	9.50	15.00	14.00
	2	05074	8.65	11.70	15074			05074MA	15074MA	0.551	14.0	11.125		14.00	13.00	18.50	17.50
	2.5	05075		15.00	15075			05075MA	15075MA	0.689	17.5	14.125		17.50	16.50	22.00	21.00
	3	05076		18.30	15076			05076MA	15076MA	0.827	21.0	17.250		21.00	20.00	25.50	24.50

Drill Depth: The minimum drilling depth "S" allows for one pitch chip clearance between the tip of the tap and the bottom of the drilled hole. "S" minimum allows for tap clearance, the maximum amount of insert set-down and countersink. Where a spiral pointed tap is used, the drill depths shown should be increased to allow for chip clearance.

Fitted Insert:

- R = Maximum length of engaged portion of screw when tang is removed.
- Q = Minimum full tapped thread length.
- T = Minimum tapping depth - including 3 1/2 threads of plug tap.
- S = Minimum drill depth - excluding point.

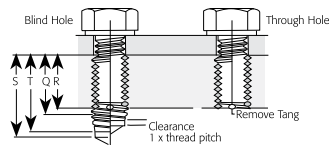

Note: Recoil metric inserts are made to Din locking torque requirements. Military specification MA parts need to be specifically ordered by adding MA to the standard part number above.

Note: Dimensions shown are for MA parts only.

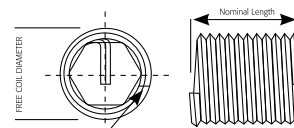

Recoil Metric Insert Part Number Call-Out and Dimensional Data

Thread Nominal	Nominal Length	Recoil Spec - Free Running Free			Recoil Spec - Screw Locking Free			MA Spec		BASIC LENGTH OF INSERT NOMINAL DIAMETER OF SCREW "D"							
		Part Number	Coil Dia Min./Max.	Number of Coils	Part Number	Coil Dia Min./Max.	Number of Coils	Free Running Part Number	Screw Locking Part Number	Insert Length inch	mm	Number of Coils	Free Coil Dia Min./Max.	Q	R	S	T
M8 x 0.75	1	08082		8.60	18082				18082	0.315	8	7.85	8.00	7.25	11.38	10.63	
	1.5	08083	9.00	13.75	18083				18083	0.472	12	12.6	12.00	11.25	15.38	14.63	
	2	08084	9.18	18.75									16.00	15.25	19.38	18.63	
M8 x 1	1	07082		6.15	17082			07082MA	17082	0.315	8.0	5.875	8.00	7.00	12.50	11.50	
	1.5	07083	9.40	9.85	17083	AS PER "MA SPECIFICATION"		07083MA	17083	0.472	12.0	9.375	9.70	12.00	11.00	16.50	15.50
	2	07084	9.65	13.65	17084			07084MA	17084	0.63	16.0	13.000	10.25	16.00	15.00	20.50	19.50
	2.5	07085		17.45	17085			07085MA	17085	0.787	20.0	16.500		20.00	19.00	24.50	23.50
	3	07086		21.15	17086			07086MA	17086	0.945	24.0	20.125		24.00	23.00	28.50	27.50
M8 x 1.25	1	05082		4.55	15082	AS PER "MA SPECIFICATION"		05082MA	15082MA	0.394	10.0	4.500	8.00	6.75	13.63	12.38	
	1.5	05083	9.60	7.55	15083			05083MA	15083MA	0.472	12.0	7.375	9.80	12.00	10.75	17.63	16.38
	2	05084	9.80	10.55	15084			05084MA	15084MA	0.63	16.0	10.250	10.35	16.00	14.75	21.63	20.38
	2.5	05085		13.55	15085			05085MA	15085MA	0.787	20.0	13.250		20.00	18.75	25.63	24.38
	3	05086		16.55	15086		05086MA	15086MA	0.945	24.0	16.125		24.00	22.75	29.63	28.38	
M9 x 1	1	07092		7.05		Upon Request				0.354	9.0		9.00	8.00	13.50	12.50	
	1.5	07093	10.41	11.35							0.531	13.5		13.50	12.50	18.00	17.00
	2	07094	10.65	15.65							0.709	18.0		18.00	17.00	22.50	21.50
	2.5	07095		19.85							0.886	22.5		22.50	21.50	27.00	26.00
	3	07096		24.15							1.063	27.0		27.00	26.00	31.50	30.50
M9 x 1.25	1	05092		5.35		Upon Request				0.354	9.0		9.00	7.75	14.63	13.38	
	1.5	05093	10.68	8.75							0.531	13.5		13.50	12.25	19.13	17.88
	2	05094	10.92	12.15							0.709	18.0		18.00	16.75	23.63	22.38
	2.5	05095		15.55							0.886	22.5		22.50	21.25	28.13	26.88
	3	05096		18.95							1.063	27.0		27.00	25.75	32.63	31.38
M10 x 1	1	08102		8.05			08102MA	18102MA	0.394	10.0	7.625		10.00	9.00	14.50	13.50	
	1.5	08103	11.34	12.75			08103MA	18103MA	0.591	15.0	12.00	11.95	15.00	14.00	19.50	18.50	
	2	08104	11.63	17.55			08104MA	18104MA	0.787	20.0	16.50	12.5	20.00	19.00	24.50	23.50	
	2.5	08105		22.25			08105MA	18105MA	0.984	25.0	21.00		25.00	24.00	29.50	28.50	
	3	08106		26.95			08106MA	18106MA	1.181	30.0	25.50		30.00	29.00	34.50	33.50	
M10 x 1.25	1	07102		6.05	17102		07102MA	17102MA	0.394	10.0	5.875		10.00	8.75	15.63	14.38	
	1.5	07103	11.80	9.85	17103		07103MA	17103MA	0.591	15.0	9.500	12.10	15.00	13.75	20.63	19.38	
	2	07104	12.10	13.55	17104		07104MA	17104MA	0.787	20.0	13.125	12.65	20.00	18.75	25.63	24.38	
	2.5	07105		17.35	17105		07105MA	17105MA	0.984	25.0	16.750		25.00	23.75	30.63	29.38	
	3	07106		21.15	17106		07106MA	17106MA	1.181	30.0	20.375		30.00	28.75	35.63	34.38	
M10 x 1.5	1				15102		05102	15102MA	0.394	10.0	4.875		10.00	8.50	16.75	15.25	
	1.5				15103		05103	15103MA	0.591	15.0	8.000	11.95	15.00	13.50	21.75	20.25	
	2				15104		05104	15104MA	0.787	20.0	11.125	12.50	20.00	18.50	26.75	25.25	
	2.5				15105		05105	15105MA	0.984	25.0	14.250		25.00	23.50	31.75	30.25	
	3				15106		05106	15106MA	1.181	30.0	17.375		30.00	28.50	36.75	35.25	
M11 x 1	1	08112		8.95						0.433	11.0		11.00	12.00	15.50	14.50	
	1.5	08113	12.40	14.15						0.866	22.0		16.50	15.50	21.00	20.00	
	2	08114	12.70	19.35						1.083	27.5		22.00	21.00	26.50	25.50	
	2.5	08115		24.55						1.299	33.0		27.50	26.50	32.00	31.00	
	3	08116		29.75						0.433	11.0		33.00	32.00	37.50	36.50	

Drill Depth: The minimum drilling depth "S" allows for one pitch chip clearance between the tip of the tap and the bottom of the drilled hole. "S" minimum allows for tap clearance, the maximum amount of insert set-down and countersink. Where a spiral pointed tap is used, the drill depths shown should be increased to allow for chip clearance.

Fitted Insert:

- R = Maximum length of engaged portion of screw when tang is removed.
- Q = Minimum full tapped thread length.
- T = Minimum tapping depth - including 3 1/2 threads of plug tap.
- S = Minimum drill depth - excluding point.

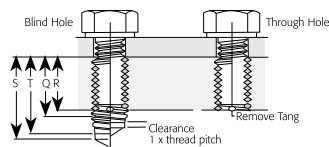

Note: Recoil metric inserts are made to Din locking torque requirements. Military specification MA parts need to be specifically ordered by adding MA to the standard part number above.

Note: Dimensions shown are for MA parts only.

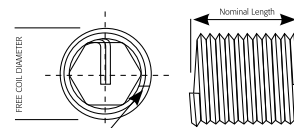

Recoil Metric Insert Part Number Call-Out and Dimensional Data

Thread Nominal	Nominal Length	Recoil Spec - Free Running Free			Recoil Spec - Screw Locking Free			MA Spec		BASIC LENGTH OF INSERT NOMINAL DIAMETER OF SCREW "D"						
		Part Number	Coil Dia Min./Max.	Number of Coils	Part Number	Coil Dia Min./Max.	Number of Coils	Free Running Part Number	Screw Locking Part Number	Insert Length inch	mm	Number of Coils	Free Coil Dia Min./Max.	Q	R	S
M11 x 1.25	1	07112		6.90									11.00	9.75	16.63	15.38
	1.5	07113	12.83	11.00					0.650	16.5			16.50	15.25	22.13	20.88
	2	07114	13.10	15.15	Upon Request				0.866	22.0			22.00	20.75	27.63	26.38
	2.5	07115		19.35					1.083	27.5			27.50	26.25	33.13	31.88
	3	07116		23.45					1.299	33.0			33.00	31.75	38.63	37.38
M11 x 1.5	1	05112		5.55					0.433	11.0			11.00	9.50	17.75	16.25
	1.5	05113	12.95	9.05					0.650	16.5			16.50	15.00	23.25	21.75
	2	05114	13.25	12.55	Upon Request				0.866	22.0			22.00	20.50	28.75	27.25
	2.5	05115		16.05					1.083	27.5			27.50	26.00	34.25	32.75
	3	05116		19.45					1.299	33.0			33.00	31.50	39.75	38.25
M12 x 1	1	08122-1.0		10.25					0.472	12.0			12.00	11.00	16.50	15.50
	1.5	08123-1.0	13.55	15.35					0.709	18.0			18.00	17.00	22.50	21.50
	2	08124-1.0	13.90	21.30	Upon Request				0.945	24.0			24.00	23.00	28.50	27.50
	2.5	08125-1.0							1.181	30.0			30.00	29.00	34.50	33.50
	3	08126-1.0							1.417	36.0			36.00	35.00	40.50	39.50
M12 x 1.25	1	08122		7.65	18122			18122MA	0.472	12.0	7.250		12.00	10.75	17.63	16.38
	1.5	08123	13.70	12.15	18123	AS PER "MA SPECIFICATION"		18123MA	0.709	18.0	11.625	14.30	18.00	16.75	23.63	22.38
	2	08124	14.05	16.65	18124		18124MA	0.945	24.0	15.875	15.00	24.00	22.75	29.63	27.38	
	2.5	08125		21.25	18125		18125MA	1.181	30.0	20.250		30.00	28.75	35.63	34.38	
	3	08126		25.75	18126		18126MA	1.417	36.0	24.500		36.00	34.75	41.63	40.38	
M12 x 1.5	1	07122		5.85	17122				07122MA	0.472	12.0	6.000		12.00	10.50	18.75
	1.5	07123	14.00	9.50	17123	AS PER "MA SPECIFICATION"		07123MA	0.709	18.0	9.625	14.25	18.00	16.50	24.75	23.25
	2	07124	14.30	13.23	17124		07124MA	0.945	24.0	13.375	14.95	24.00	22.50	30.75	29.25	
	2.5	07125		16.85	17125		07125MA	1.181	30.0	17.000		30.00	28.50	36.75	35.25	
	3	07126		20.6	17126		07126MA	1.417	36.0	20.750		36.00	34.50	42.75	41.25	
M12 x 1.75	1				15122				05122	0.472	12.0	5.000		12.00	10.25	19.88
	1.5				15123	AS PER "MA SPECIFICATION"		05123	0.709	18.0	8.250	14.30	18.00	16.25	25.88	24.13
	2				15124		05124	0.945	24.0	11.500	15.00	24.00	22.25	31.88	30.13	
	2.5				15125		05125	1.181	30.0	14.625		30.00	28.25	37.88	36.13	
	3				15126		05126	1.417	36.0	17.875		36.00	34.25	43.88	42.13	
M13 x 1.5	1	07132	15.20	6.65						0.512	13.0			13.00	11.50	19.75
	1.5	07133	15.53	10.75									19.50	18.00	26.25	24.75
	2	07134		14.95									26.00	24.50	32.75	31.25
M13 x 1.75	1	05132		5.50									13.00	11.25	20.88	19.13
	1.5	05133	15.35	9.05					0.768	19.5			19.50	17.75	27.38	25.63
	2	05134	15.75	12.60	Upon Request								26.00	24.25	33.88	32.13
	2.5	05135		16.1									32.50	30.75	40.38	38.63
	3	05136		19.65									39.00	37.25	46.88	45.13
M13 x 1.25	1	08132		8.35					0.512	13.0			13.00	11.75	18.63	17.38
	1.5	08133	14.70	13.25									19.50	18.25	25.13	23.88
	2	08134	15.05	18.25	Upon Request								26.00	24.75	31.63	30.38
	2.5	08135		23.15									32.50	31.25	38.13	36.88
	3	08136		28.15									39.00	37.75	44.63	43.38

Drill Depth: The minimum drilling depth "S" allows for one pitch chip clearance between the tip of the tap and the bottom of the drilled hole. "S" minimum allows for tap clearance, the maximum amount of insert set-down and countersink. Where a spiral pointed tap is used, the drill depths shown should be increased to allow for chip clearance.

Fitted Insert:

- R = Maximum length of engaged portion of screw when tang is removed.
- Q = Minimum full tapped thread length.
- T = Minimum tapping depth - including 3 1/2 threads of plug tap.
- S = Minimum drill depth - excluding point.

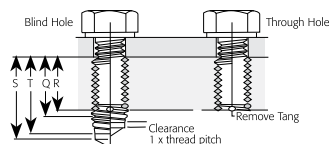

Note: Recoil metric inserts are made to Din locking torque requirements. Military specification MA parts need to be specifically ordered by adding MA to the standard part number above.

Note: Dimensions shown are for MA parts only.

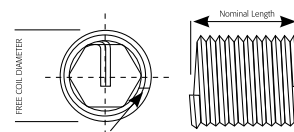

Recoil Metric Insert Part Number Call-Out and Dimensional Data

Thread Nominal	Recoil Spec - Free Running Free					Recoil Spec - Screw Locking Free			MA Spec		BASIC LENGTH OF INSERT NOMINAL DIAMETER OF SCREW "D"						
	Nominal Length	Part Number	Coil Dia Min./Max.	Number of Coils	Part Number	Coil Dia Min./Max.	Number of Coils	Free Running Part Number	Screw Locking Part Number	Insert Length inch	mm	Number of Coils	Free Coil Dia Min./Max.	SCREW "D"			
													Q	R	S	T	
M14 x 1.5	1	07142		7.35	17142		6.98	07142MA	17142MA	0.551	14.0	7.125	14.00	12.50	20.75	19.25	
	1.5	07143	16.15	11.75	17143	17.30	11.23	07143MA	17143MA	0.827	21.0	11.375	16.55	21.00	19.50	27.75	26.25
	2	07144	16.55	16.25	17144	17.60	15.48	07144MA	17144MA	1.102	28.0	15.625	17.25	28.00	26.50	34.75	33.25
	2.5	07145		20.65	17145		19.85	07145MA	17145MA	1.378	35.0	20.000		35.00	33.50	41.75	40.25
	3	07146		25.05	17146		24.10	07146MA	17146MA	1.654	42.0	24.250		42.00	40.50	48.75	47.25
M14 x 2	1				15142			05142	15142MA	0.551	14.0	5.125	14.00	12.00	23.00	21.00	
	1.5				15143			05143	15143MA	0.827	21.0	8.500	16.65	21.00	19.00	30.00	28.00
	2				15144			05144	15144MA	1.102	28.0	11.750	17.35	28.00	26.00	37.00	35.00
	2.5				15145			05145	15145MA	1.378	35.0	15.000		35.00	33.00	44.00	42.00
	3				15146			05146	15146MA	1.654	42.0	18.375		42.00	40.00	51.00	49.00
M15 x 1.5	1	07152		7.95						0.591	15.0		15.00	13.50	21.75	20.25	
	1.5	07153	17.25	12.75						0.886	22.5		22.50	21.00	29.25	27.75	
	2	07154	17.65	17.45	Upon Request					1.181	30.0		30.00	28.50	36.75	35.25	
	2.5	07155		22.25					1.476	37.5			37.50	36.00	44.25	42.75	
	3	07156		26.95					1.772	45.0			45.00	43.50	51.75	50.25	
M15 x 2	1	05152		5.55						0.591	15.0		15.00	13.00	24.00	22.00	
	1.5	05153	17.70	9.15						0.886	22.5		22.50	20.50	31.50	29.50	
	2	05154	18.10	12.70	Upon Request					1.181	30.0		30.00	28.00	39.00	37.00	
	2.5	05155		16.30					1.476	37.5			37.50	35.50	46.50	44.50	
	3	05156		19.85					1.772	45.0			45.00	43.00	54.00	52.00	
M16 x 1.5	1	07162		8.65	17162		8.65	07162MA	17162MA	0.63	16.0	8.250	16.00	14.50	22.75	21.25	
	1.5	07163	18.20	13.75	17163	18.20	13.75	07163MA	17163MA	0.945	24.0	13.125	18.90	24.00	22.50	30.75	29.25
	2	07164	18.60	18.85	17164	18.60	18.85	07164MA	17164MA	1.26	32.0	18.000	19.60	32.00	30.50	38.75	37.25
	2.5	07165		23.85	17165		23.85	07165MA	17165MA	1.575	40.0	22.750		40.00	38.50	46.75	45.25
	3	07166		28.95	17166		28.95	07166MA	17166MA	1.89	48.0	27.625		48.00	46.50	54.75	53.25
M16 x 2	1	05162		6.10	15162			05162MA	15162MA	0.63	16.0	6.125	16.00	14.00	25.00	23.00	
	1.5	05163	18.35	9.60	15163			05163MA	15163MA	0.945	24.0	9.750	18.80	24.00	22.00	33.00	31.00
	2	05164	18.55	13.70	15164			05164MA	15164MA	1.26	32.0	13.500	19.60	32.00	30.00	41.00	39.00
	2.5	05165		17.50	15165			05165MA	15165MA	1.575	40.0	17.250		40.00	38.00	49.00	47.00
	3	05166		21.15	15166			05166MA	15166MA	1.89	48.0	21.000		48.00	46.00	57.00	55.00
M18 x 1.5	1	08182		9.85	18182			08182MA	18182MA	0.709	18.0	9.500	18.00	16.50	24.75	23.25	
	1.5	08183	20.35	15.45	18183			08183MA	18183MA	1.063	27.0	15.000	21.05	27.00	25.50	33.75	32.25
	2	08184	20.75	21.05	18184			08184MA	18184MA	1.417	36.0	20.375	21.75	36.00	34.50	42.75	41.25
	2.5	08185		26.75	18185			08185MA	18185MA	1.772	45.0	25.875		45.00	43.50	51.75	50.25
	3	08186		32.35	18186			08186MA	18186MA	2.126	54.0	31.375		54.00	52.50	60.75	59.25
M18 x 2	1	07182			17182				17182MA	0.709	18.0	7.000	18.00	16.00	27.00	25.00	
	1.5	07183	AS PER "MA SPECIFICATION"		17183	AS PER "MA SPECIFICATION"			17183MA	1.063	27.0	11.125	21.15	27.00	25.00	36.00	34.00
	2	07184	AS PER "MA SPECIFICATION"		17184	AS PER "MA SPECIFICATION"			17184MA	1.417	36.0	15.375	21.85	36.00	34.00	45.00	43.00
	2.5	07185			17185				17185MA	1.772	45.0	19.500		45.00	43.00	54.00	52.00
	3	07186			17186				17186MA	2.126	54.0	23.625		54.00	52.00	63.00	61.00
M18 x 2.5	1	05182			15182				15182MA	0.709	18.0	5.375	18.00	15.50	29.25	26.75	
	1.5	05183	AS PER "MA SPECIFICATION"		15183	AS PER "MA SPECIFICATION"			15183MA	1.063	27.0	8.875	21.30	27.00	24.50	38.25	35.75
	2	05184	AS PER "MA SPECIFICATION"		15184	AS PER "MA SPECIFICATION"		15184MA	1.417	36.0	12.250	22.00	36.00	33.50	47.25	44.75	
	2.5	05185			15185				15185MA	1.772	45.0	15.625		45.00	42.50	56.25	53.75
	3	05186			15186				15186MA	2.126	54.0	19.000		54.00	51.50	65.25	62.75

Drill Depth: The minimum drilling depth "S" allows for one pitch chip clearance between the tip of the tap and the bottom of the drilled hole. "S" minimum allows for tap clearance, the maximum amount of insert set-down and countersink. Where a spiral pointed tap is used, the drill depths shown should be increased to allow for chip clearance.

Fitted Insert:

- R = Maximum length of engaged portion of screw when tang is removed.
- Q = Minimum full tapped thread length.
- T = Minimum tapping depth - including 3 1/2 threads of plug tap.
- S = Minimum drill depth - excluding point.

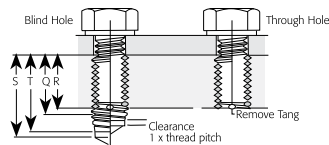

Note: Recoil metric inserts are made to Din locking torque requirements. Military specification MA parts need to be specifically ordered by adding MA to the standard part number above.

Note: Dimensions shown are for MA parts only.

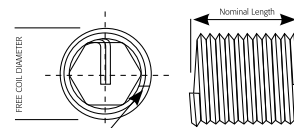

Recoil Metric Insert Part Number Call-Out and Dimensional Data

Thread Nominal	Nominal Length	Recoil Spec - Free Running Free			Recoil Spec - Screw Locking Free			MA Spec		BASIC LENGTH OF INSERT NOMINAL DIAMETER OF SCREW "D"								
		Part Number	Coil Dia Min./Max.	Number of Coils	Part Number	Coil Dia Min./Max.	Number of Coils	Free Running Part Number	Screw Locking Part Number	Insert Length inch	mm	Number of Coils	Free Coil Dia Min./Max.	Q R S T				
M20 x 1.5	1	08202		11.25	18202			08202MA	18202MA	0.787	20.0	10.750	20.00	18.50	26.75	25.25		
	1.5	08203	22.08	17.65	18203		AS PER "MA SPECIFICATION"	08203MA	18203MA	1.181	30.0	16.875	23.15	30.00	36.75	35.25		
	2	08204	22.50	23.95	18204			08204MA	18204MA	1.575	40.0	22.875	24.00	40.00	46.75	45.25		
	2.5	08205		30.35	18205			08205MA	18205MA	1.969	50.0	28.875		50.00	56.75	55.25		
	3	08206		36.75	18206			08206MA	18206MA	2.362	60.0	35.000		60.00	66.75	65.25		
M20 x 2	1	07202		8.05	17202			07202MA	17202MA	0.787	20.0	7.875	20.00	18.00	29.00	27.00		
	1.5	07203	22.97	12.75	17203		AS PER "MA SPECIFICATION"	07203MA	17203MA	1.181	30.0	12.500	23.20	30.00	39.00	37.00		
	2	07204	23.40	17.45	17204			07204MA	17204MA	1.575	40.0	17.250	24.05	40.00	49.00	47.00		
	2.5	07205		22.25	17205			07205MA	17205MA	1.969	50.0	21.875		50.00	59.00	57.00		
	3	07206		26.95	17206			07206MA	17206MA	2.362	60.0	26.500		60.00	69.00	67.00		
M20 x 2.5	1				15202			05202	15202MA	0.787	20.0	6.125	20.00	17.50	31.25	28.75		
	1.5				15203		AS PER "MA SPECIFICATION"	05203	15203MA	1.181	30.0	9.875	23.55	30.00	41.25	38.75		
	2				15204			05204	15204MA	1.575	40.0	13.625	24.40	40.00	51.25	48.75		
	2.5				15205			05205	15205MA	1.969	50.0	17.375		50.00	61.25	58.75		
	3				15206			05206	15206MA	2.362	60.0	21.125		60.00	71.25	68.75		
M22 x 1.5	1	08222		12.55				08222MA	18222MA	0.866	22.0	11.875	22.00	20.50	28.75	27.25		
	1.5	08223	23.90	19.75			AS PER "MA SPECIFICATION"	08223MA	18223MA	1.299	33.0	18.500	25.55	33.00	39.75	38.25		
	2	08224	24.45	26.65				08224MA	18224MA	1.732	44.0	25.125	26.45	44.00	50.75	49.25		
	2.5	08225		33.65				08225MA	18225MA	2.165	55.0	31.625		55.00	61.75	60.25		
	3	08226		40.65				08226MA	18226MA	2.598	66.0	38.250		66.00	72.75	71.25		
M22 x 2	1	07222		9.05	17222			07222MA	17222MA	0.787	20.0	8.750	22.00	20.00	31.00	29.00		
	1.5	07223	25.00	14.25	17223		AS PER "MA SPECIFICATION"	07223MA	17223MA	1.181	30.0	13.750	25.60	33.00	42.00	40.00		
	2	07224	25.40	19.45	17224			07224MA	17224MA	1.575	40.0	18.875	26.50	44.00	53.00	51.00		
	2.5	07225		24.65	17225			07225MA	17225MA	1.969	50.0	23.875		55.00	64.00	62.00		
	3	07226		30.15	17226			07226MA	17226MA	2.362	60.0	29.000		66.00	75.00	73.00		
M22 x 2.5	1				15222			05222	15222MA	0.866	22.0	6.750	22.00	19.50	33.25	30.75		
	1.5				15223			05223	15223MA	1.299	33.0	10.875	25.90	33.00	44.25	41.75		
	2				15224			05224	15224MA	1.732	44.0	14.875	26.90	44.00	55.25	52.75		
	2.5				15225			05225	15225MA	2.165	55.0	19.000		55.00	66.25	63.75		
	3				15226			05226	15226MA	2.598	66.0	23.125		66.00	77.25	74.75		
M24 x 1.5	1	08242		13.85	18242		13.85			0.945	24.0		24.00	22.50	30.75	29.25		
	1.5	08243	26.10	21.55	18243	26.10	21.55			1.417	36.0		36.00	34.50	42.75	41.25		
	2	08244	26.60	29.15	18244	26.60	29.15			1.89	48.0		48.00	46.50	54.75	53.25		
	2.5	08245		36.85	18245		36.85			2.362	60.0		60.00	58.50	66.75	65.25		
	3	08246		44.45	18246		44.45			2.835	72.0		72.00	70.50	78.75	77.25		
M24 x 2	1	07242		9.95	17242			07242MA	17242MA	0.945	24.0	9.500	24.00	22.00	33.00	31.00		
	1.5	07243	27.00	15.65	17243		AS PER "MA SPECIFICATION"	07243MA	17243MA	1.417	36.0	15.000	28.10	36.00	45.00	43.00		
	2	07244	27.50	21.45	17244			07244MA	17244MA	1.89	48.0	20.375	29.10	48.00	57.00	55.00		
	2.5	07245		27.15	17245			07245MA	17245MA	2.362	60.0	25.875		60.00	69.00	67.00		
	3	07246		32.85	17246			07246MA	17246MA	2.835	72.0	31.250		72.00	81.00	79.00		
M24 x 3	1				15242			05242	15242MA	0.945	24.0	6.125	24.00	21.00	37.50	34.50		
	1.5				15243		AS PER "MA SPECIFICATION"	05243	15243MA	1.417	36.0	10.000	28.00	36.00	49.50	46.50		
	2				15244			05244	15244MA	1.89	48.0	13.750	29.00	48.00	61.50	58.50		
	2.5				15245			05245	15245MA	2.362	60.0	17.500		60.00	73.50	70.50		
	3				15246			05246	15246MA	2.835	72.0	21.375		72.00	85.50	82.50		

Drill Depth: The minimum drilling depth "S" allows for one pitch chip clearance between the tip of the tap and the bottom of the drilled hole. "S" minimum allows for tap clearance, the maximum amount of insert set-down and countersink. Where a spiral pointed tap is used, the drill depths shown should be increased to allow for chip clearance.

Fitted Insert:

- R = Maximum length of engaged portion of screw when tang is removed.
- Q = Minimum full tapped thread length.
- T = Minimum tapping depth - including 3 1/2 threads of plug tap.
- S = Minimum drill depth - excluding point.

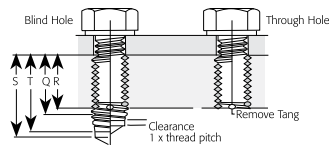

Note: Recoil metric inserts are made to Din locking torque requirements. Military specification MA parts need to be specifically ordered by adding MA to the standard part number above.

Note: Dimensions shown are for MA parts only.

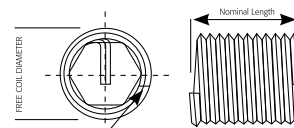

Recoil Metric Insert Part Number Call-Out and Dimensional Data

Thread Nominal	Nominal Length	Recoil Spec - Free Running Free			Recoil Spec - Screw Locking Free			MA Spec		BASIC LENGTH OF INSERT NOMINAL DIAMETER OF SCREW "D"							
		Part Number	Coil Dia Min./Max.	Number of Coils	Part Number	Coil Dia Min./Max.	Number of Coils	Free Running Part Number	Screw Locking Part Number	Insert Length inch	mm	Number of Coils	Free Coil Dia Min./Max.	Q	R	S	T
M26 x 1.5	1	08262		15.15					1.024	26.0			26.50	24.50	32.75	31.25	
	1.5	08263	28.10	23.45					1.535	39.0			39.00	37.50	45.75	44.25	
	2	08264	28.60	31.75	Upon Request				2.047	52.0			52.00	50.50	58.75	57.25	
	2.5	08265		40.05					2.559	65.0			65.00	63.50	71.75	70.25	
	3	08266		48.35					3.071	78.0			78.00	76.50	84.75	83.25	
M27 x 1.5	1	08272		15.85					1.063	27.0							
	1.5	08273	29.10	24.45					1.594	40.5							
	2	08274	29.6	33.15	Upon Request				2.126	54.0							
	2.5	08275		41.8					2.657	67.5							
	3	08276		50.45					3.189	81.0							
M27 x 2	1	07272		11.08	17272			07272MA	17272MA	1.063	27.0	10.875	27.00	25.00	36.00	34.00	
	1.5	07273	30.40	17.40	17273	AS PER "MA SPECIFICATION"		07273MA	17273MA	1.594	40.5	17.000	31.30	40.50	38.50	49.50	47.50
	2	07274	30.85	23.87	17274			07274MA	17274MA	2.126	54.0	23.250	32.30	54.00	52.00	63.00	61.00
	2.5	07275		30.2	17275			07275MA	17275MA	2.657	67.5	29.375		67.50	65.50	76.50	74.50
	3	07276		36.52	17276			07276MA	17276MA	3.189	81.0	35.500		81.00	79.00	90.00	88.00
M27 x 3	1				15272		AS PER "MA SPECIFICATION"		05272	15272MA	1.063	27.0	7.000	27.00	24.00	40.50	37.50
	1.5				15273			05273	15273MA	1.594	40.5	11.250	31.40	40.50	37.50	54.00	51.00
	2				15274			05274	15274MA	2.126	54.0	15.500	32.40	54.00	51.00	67.50	64.50
	2.5				15275			05275	15275MA	2.657	67.5	19.750		67.50	64.50	81.00	78.00
	3				15276			05276	15276MA	3.189	81.0	24.000		81.00	78.00	94.50	91.50
M30 x 1.5	1	08302		17.45					1.181	30.0							
	1.5	08303	32.50	26.95					1.772	45.0							
	2	08304	32.80	36.55	Upon Request				2.362	60.0							
	2.5	08305		46.05					2.953	75.0							
	3	08306		55.55					3.543	90.0							
M30 x 2	1	07302		12.48	17302	AS PER "MA SPECIFICATION"		07302MA	17302MA	1.181	30.0	12.250	30.00	28.00	39.00	37.00	
	1.5	07303	33.55	19.58	17303			07303MA	17303MA	1.772	45.0	19.125	34.50	45.00	43.00	54.00	52.00
	2	07304	34.00	26.54	17304			07304MA	17304MA	2.362	60.0	25.875	35.70	60.00	58.00	69.00	67.00
	2.5	07305		33.62	17305			07305MA	17305MA	2.953	75.0	32.750		75.00	73.00	84.00	82.00
	3	07306		40.58	17306			07306MA	17306MA	3.543	90.0	39.500		90.00	88.00	99.00	97.00
M30 x 3	1	05302-3			15302-3	AS PER "MA SPECIFICATION"		15302-3MA	1.181	30.0	7.875		30.00	27.00	43.50	40.50	
	1.5	05303-3			15303-3			15303-3MA	1.772	45.0	12.500	34.90	45.00	42.00	58.50	55.50	
	2	05304-3			15304-3			15304-3MA	2.362	60.0	17.125	36.10	60.00	57.00	73.50	70.50	
	2.5	05305-3			15305-3			15305-3MA	2.953	75.0	21.875		75.00	72.00	88.50	85.50	
	3	05306-3			15306-3			15306-3MA	3.543	90.0	26.500		90.00	87.00	103.50	100.50	
M30 x 3.5	1	05302		6.65	15302	AS PER "MA SPECIFICATION"			1.181	30.0			30.00	26.50	45.75	42.25	
	1.5	05303	34.85	10.75	15303				1.772	45.0			45.00	41.50	60.75	57.25	
	2	05304	35.35	14.89	15304				2.362	60.0			60.00	56.50	75.75	72.25	
	2.5	05305		18.95	15305				2.953	75.0			75.00	71.50	90.75	87.25	
	3	05306		23.13	15306				3.543	90.0			90.00	86.50	105.75	102.25	
M33 x 2	1	07332		13.93	17332	AS PER "MA SPECIFICATION"			1.299	33.0	13.625		33.00	31.00	42.00	40.00	
	1.5	07333	36.70	21.67	17333				1.949	49.5	21.125	37.80	49.50	47.50	58.50	56.50	
	2	07334	37.15	39.42	17334			Upon Request	17334MA	2.598	66.0	28.625	39.20	66.00	64.00	75.00	73.00
	2.5	07335		37.03	17335				17335MA	3.248	82.5	36.000		82.50	80.50	91.50	89.50
	3	07336		44.78	17336				17336MA	3.898	99.0	43.500		99.00	97.00	108.00	106.00

Drill Depth: The minimum drilling depth "S" allows for one pitch chip clearance between the tip of the tap and the bottom of the drilled hole. "S" minimum allows for tap clearance, the maximum amount of insert set-down and countersink. Where a spiral pointed tap is used, the drill depths shown should be increased to allow for chip clearance.

Fitted Insert:

- R = Maximum length of engaged portion of screw when tang is removed.
- Q = Minimum full tapped thread length.
- T = Minimum tapping depth - including 3 1/2 threads of plug tap.
- S = Minimum drill depth - excluding point.

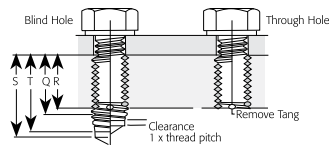

Note: Recoil metric inserts are made to Din locking torque requirements. Military specification MA parts need to be specifically ordered by adding MA to the standard part number above.

Note: Dimensions shown are for MA parts only.

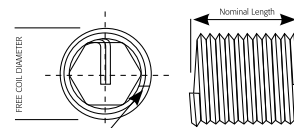

Recoil Metric Insert Part Number Call-Out and Dimensional Data

Thread Nominal	Nominal Length	Recoil Spec - Free Running Free			Recoil Spec - Screw Locking Free			MA Spec		BASIC LENGTH OF INSERT NOMINAL DIAMETER OF SCREW "D"							
		Part Number	Coil Dia Min./Max.	Number of Coils	Part Number	Coil Dia Min./Max.	Number of Coils	Free Running Part Number	Screw Locking Part Number	Insert Length inch	mm	Number of Coils	Free Coil Dia Min./Max.	Q	R	S	T
M33 x 3	1	07332-3		9.05	17332-3MA					1.299	33.00	8.750	33.00	30.00	46.50	43.50	
	1.5	07333-3	37.65	14.25	17333-3MA					1.949	49.50	13.875	38.10	49.50	46.50	63.00	60.00
	2	07334-3	38.00		17334-3MA					2.598	66.00	19.000	39.50	66.00	63.00	79.50	76.50
	2.5	07335-3			17335-3MA					3.248	82.50	24.125		82.50	79.50	96.00	93.00
	3	07336-3			17336-3MA					3.898	99.00	29.250		99.00	96.00	112.50	109.50
M33 x 3.5	1	05332		7.55	15332					1.299	33.0		33.00	29.50	48.75	45.25	
	1.5	05333	38.20	11.95	15333					1.949	49.5		49.50	46.00	65.25	61.75	
	2	05334	38.55	16.40	15334					2.598	66.0		66.00	62.50	81.75	78.25	
	2.5	05335		21.15	15335					3.248	82.5		82.50	79.00	98.25	94.75	
	3	05336		25.30	15336					3.898	99.0		99.00	95.50	114.75	111.25	
M36 x 1.5	1	08362		22.15	18362					1.417	36.0		36.00	34.50	42.75	41.25	
	1.5	08363	38.45	33.95	18363					2.126	54.0		54.00	52.50	60.75	59.25	
	2	08364	38.95	45.75	18364					2.835	72.0		72.00	70.50	78.75	77.25	
	2.5	08365		57.65	18365					3.543	90.0		90.00	88.50	96.75	95.25	
	3	08366		69.45	18366					4.252	108.0		108.00	106.50	114.75	113.25	
M36 x 2	1	07362-2		16.15	17362-2					1.417	36.0	15.000	36.00	34.00	45.00	43.00	
	1.5	07363-2	39.52	25.05	17363-2	AS PER "MA SPECIFICATION"				2.126	54.0	23.250	41.00	54.00	52.00	63.00	61.00
	2	07364-2	40.05	33.75	17364-2					2.835	72.0	31.375	42.40	72.00	70.00	81.00	79.00
	2.5	07365-2		42.65	17365-2					3.543	90.0	39.500		90.00	88.00	99.00	97.00
	3	07366-2		51.45	17366-2					4.252	108.0	47.750		108.00	106.00	117.00	115.00
M36 x 3	1							07362		1.417	36.0	9.750	36.00	33.00	49.50	46.50	
	1.5							07363		2.126	54.0	15.250	41.30	54.00	51.00	67.50	64.50
	2				Upon Request			07364		2.835	72.0	20.875	42.70	72.00	69.00	85.50	82.50
	2.5							07365		3.543	90.0	26.500		90.00	87.00	103.50	100.50
	3							07366		4.252	108.0	32.000		108.00	105.00	121.50	118.50
M36 x 4.0	1	05362		7.00	15362					1.417	36.0		36.00	32.00	54.00	50.00	
	1.5	05363	41.90	11.35	15363					2.126	54.0		54.00	50.00	72.00	68.00	
	2	05364	42.40	15.75	15364					2.835	72.0		72.00	68.00	90.00	86.00	
	2.5	05365		20.05	15365					3.543	90.0		90.00	86.00	108.00	104.00	
	3	05366		24.35	15366					4.252	108.0		108.00	104.00	126.00	122.00	
M39 x 2	1	08392		16.95	18392				08392MA	1.535	39.0	16.375	39.00	37.00	48.00	46.00	
	1.5	08393	42.40	26.25	18393	AS PER "MA SPECIFICATION"				2.303	58.5	25.250	44.30	58.50	56.50	67.50	65.50
	2	08394	43.05	35.55	18394					3.071	78.0	34.125	45.70	78.00	76.00	87.00	85.00
	2.5	08395		44.85	18395					3.839	97.5	43.000		97.50	95.50	106.50	104.50
	3	08396		54.15	18396					4.606	117.0	51.87		117.00	115.00	126.00	124.00
M39 x 3	1	07392		10.95	17392					1.535	39.0	10.750	39.00	36.00	52.50	49.50	
	1.5	07393	43.87	17.15	17393	AS PER "MA SPECIFICATION"				2.303	58.5	16.750	44.40	58.50	55.50	72.00	69.00
	2	07394	44.30	23.35	17394			Upon Request		3.071	78.0	22.750	45.80	78.00	75.00	91.50	88.50
	2.5	07395		29.55	17395					3.839	97.5	28.875		97.50	94.50	111.00	108.00
	3	07396		35.75	17396					4.606	117.0	34.875		117.00	114.00	130.50	127.50
M39 x 4	1	05392		7.80	15392					1.535	39.0		39.00	35.00	57.00	53.00	
	1.5	05393	45.05	12.50	15393					2.303	58.5		58.50	54.50	76.50	72.50	
	2	05394	45.55	17.15	15394					3.071	78.0		78.00	74.00	96.00	92.00	
	2.5	05395		21.85	15395					3.839	97.5		97.50	93.50	115.50	111.50	
	3	05396		23.55	15396					4.606	117.0		117.00	113.00	135.00	131.00	

Drill Depth: The minimum drilling depth "S" allows for one pitch chip clearance between the tip of the tap and the bottom of the drilled hole. "S" minimum allows for tap clearance, the maximum amount of insert set-down and countersink. Where a spiral pointed tap is used, the drill depths shown should be increased to allow for chip clearance.

Fitted Insert:

- R = Maximum length of engaged portion of screw when tang is removed.
- Q = Minimum full tapped thread length.
- T = Minimum tapping depth - including 3 1/2 threads of plug tap.
- S = Minimum drill depth - excluding point.

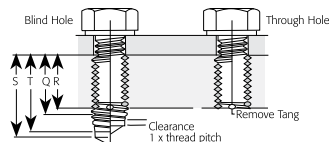

Note: Recoil metric inserts are made to Din locking torque requirements. Military specification MA parts need to be specifically ordered by adding MA to the standard part number above.

Note: Dimensions shown are for MA parts only.

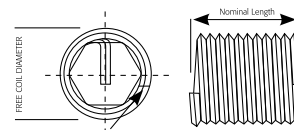

Recoil Metric Insert Part Number Call-Out and Dimensional Data

Thread Nominal	Nominal Length	Recoil Spec - Free Running Free			Recoil Spec - Screw Locking Free			MA Spec		BASIC LENGTH OF INSERT NOMINAL DIAMETER OF SCREW "D"							
		Part Number	Coil Dia Min./Max.	Number of Coils	Part Number	Coil Dia Min./Max.	Number of Coils	Free Running Part Number	Screw Locking Part Number	Insert Length inch	Insert Length mm	Number of Coils	Free Coil Dia Min./Max.	Q	R	S	T
M42 x 2	1	08422		19.15						1.654	42.0			42.00	40.00	51.00	49.00
	1.5	08423	44.70	29.45					2.480	63.0			63.00	61.00	72.00	70.00	
	2	08424	45.50	39.85	Upon Request				3.307	84.0			84.00	82.00	93.00	91.00	
	2.5	08425		50.15									105.00	103.00	114.00	112.00	
	3	08426		60.45									126.00	124.00	135.00	133.00	
M42 x 3	1	07422		11.75					1.654	42.0			42.00	39.00	55.50	52.50	
	1.5	07423	47.20	18.45					2.480	63.0			63.00	60.00	76.50	73.50	
	2	07424	47.85	26.05	Upon Request				3.307	84.0			84.00	81.00	97.50	94.50	
	2.5	07425		31.75									105.00	102.00	118.50	115.50	
	3	07426		38.45									126.00	123.00	139.50	136.50	
M42 x 4.5	1	05422		7.35					1.654	42.0			42.00	37.50	62.25	57.75	
	1.5	05423	48.5	11.85					2.480	63.0			63.00	58.50	83.25	78.75	
	2	05424	49.00	16.35	Upon Request				3.307	84.0			84.00	79.50	104.25	99.75	
	2.5	05425		20.85									105.00	100.50	125.50	120.75	
	3	05426		25.35									126.00	121.50	146.25	141.75	
M42 x 4	1	05422-4		8.50					1.654	42.0			42.00	38.00	60.00	56.00	
	1.5	05423-4	48.50	13.45					2.480	63.0			63.00	59.00	81.00	77.00	
	2	05424-4	49.00	18.65	Upon Request				3.307	84.0			84.00	80.00	102.00	98.00	
	2.5	05425-4		23.65									105.00	101.00	123.00	119.00	
	3	05426-4		28.65									126.00	122.00	144.00	140.00	
M45 x 3	1	07452		12.70									45.00	42.00	58.50	55.50	
	1.5	07453	50.30	19.85					2.657	67.5			67.50	64.50	81.00	78.00	
	2	07454	51.00	26.95	Upon Request								90.00	87.00	103.50	100.50	
	2.5	07455		34.15									112.50	109.50	126.00	123.00	
	3	07456		41.25									135.00	132.00	148.50	145.50	
M48 x 3	1	07482		13.65									48.00	45.00	61.50	58.50	
	1.5	07483	52.50	21.25					2.835	72.0			72.00	69.00	85.50	82.50	
	2	07484	53.5	28.85	Upon Request								96.00	93.00	109.50	106.50	
	2.5	07485		36.45									120.00	117.00	133.50	130.50	
	3	07486		44.15									144.00	141.00	157.50	154.50	
M48 x 5	1	05482											48.00	45.00	70.50	65.50	
	1.5	05483	55.47	12.15					2.835	72.0			72.00	67.00	94.50	89.50	
	2	05484	56.4	17.10	Upon Request								96.00	91.00	118.50	113.50	
	2.5	05485											120.00	115.00	142.50	137.50	
	3	05486											144.00	139.00	166.50	161.50	
M48 x 4	1.5	05483-4	53.80	15.56	Upon Request				2.835	72.0			72.00	68.00	90.00	86.00	
			54.30														
M52 x 5	1.5	05523	59.53	13.45	Upon Request				3.071	78.0			78.00	73.00	100.50	95.50	
	2	05524	60.25	18.00									104.00	99.00	126.50	121.50	
M52 x 3	1	07522	57.37	15.00	Upon Request				3.071	78.0							
	1.5	07523	57.90	23.20									78.00	75.00	91.50	88.50	

Drill Depth: The minimum drilling depth "S" allows for one pitch chip clearance between the tip of the tap and the bottom of the drilled hole. "S" minimum allows for tap clearance, the maximum amount of insert set-down and countersink. Where a spiral pointed tap is used, the drill depths shown should be increased to allow for chip clearance.

Fitted Insert:

- R = Maximum length of engaged portion of screw when tang is removed.
- Q = Minimum full tapped thread length.
- T = Minimum tapping depth - including 3 1/2 threads of plug tap.
- S = Minimum drill depth - excluding point.

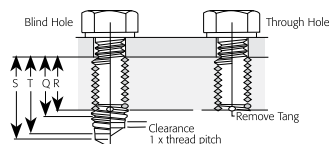

Note: Recoil metric inserts are made to Din locking torque requirements. Military specification MA parts need to be specifically ordered by adding MA to the standard part number above.

Note: Dimensions shown are for MA parts only.

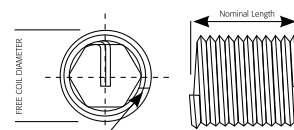

Recoil Metric Strip-Feed Insert Part Numbers

Thread Nominal	Strip Feed Free Running		Strip Feed Locking		Strip Feed Free Running		Strip Feed Pt No. MA Locking	Strip Feed Pt No. MA Locking	No. of Inserts
	Pt No.	MA	Pt No.	MA	Pt No.	MA			

Magazine on Reels Dia 385

M8 x 0.75	08082SF	18082SF	18082SF	18082SF	18102MASF	18102MASF	500
	08083SF	18083SF	18083SF	18083SF			
M8 x 1.25	05083SF	15083SF	15083SF	15083SF	15083MASF	15083MASF	500
	05084SF	15084SF	15084SF	15084SF			
M9 x 1	Upon Request						500
M9 x 1.25	Upon Request						
M10 x 1	08102SF	18102SF	18102SF	18102SF	18102MASF	18102MASF	500
	08103SF	18103SF	18103SF	18103SF			
	08104SF	18104SF	18104SF	18104SF			
M10 x 1.25	07102SF	17102SF	17102SF	17102SF	17102MASF	17102MASF	500
	07103SF	17103SF	17103SF	17103SF			
	07104SF	17104SF	17104SF	17104SF			
M10 x 1.5	05102SF	15102SF	15102SF	15102SF	15102MASF	15102MASF	500
	05103SF	15103SF	15103SF	15103SF			
	05104SF	15104SF	15104SF	15104SF			
M11 x 1	Upon Request						500
M11 x 1.25	Upon Request						
M11 x 1.5	Upon Request						

Thread Nominal	Strip Feed Free Running		Strip Feed Locking		Strip Feed Free Running		Strip Feed Pt No. MA Locking	Strip Feed Pt No. MA Locking	No. of Inserts
	Pt No.	MA	Pt No.	MA	Pt No.	MA			

Magazine on Reels Dia 290

M3 x 0.5	05034SF	15034SF	15034SF	15034MASF	15034MASF	1000
	05035SF	15035SF	15035SF	15035MASF		
M4 x 0.7	05043SF	15043SF	15043SF	15043MASF	15043MASF	1000
	05044SF	15044SF	15044SF	15044MASF		
M5 x 0.8	05045SF	15045SF	15045SF	15045MASF	15045MASF	500
	05046SF	15046SF	15046SF	15046MASF		
M6 x 1	05052SF	15052SF	15052SF	15052MASF	15052MASF	1000
	05053SF	15053SF	15053SF	15053MASF		
	05054SF	15054SF	15054SF	15054MASF		
	05055SF	15055SF	15055SF	15055MASF		
	05063SF	15063SF	15063SF	15063MASF		
	05064SF	15064SF	15064SF	15064MASF		
M8 x 1	07082SF	17082SF	17082SF	17082MASF	17082MASF	500
	07083SF	17083SF	17083SF	17083MASF		
	07084SF	17084SF	17084SF	17084MASF		

Thread Nominal	Strip Feed Free Running		Strip Feed Locking		Strip Feed Free Running		Strip Feed Pt No. MA Locking	Strip Feed Pt No. MA Locking	No. of Inserts
	Pt No.	MA	Pt No.	MA	Pt No.	MA			

Magazine on Reels Dia 200

M2.2 x 0.45	05012SF	15012SF	15012MASF	15012MASF	15012MASF	1000
	05013SF	15013SF	15013MASF	15013MASF		
	05014SF	15014SF	15014MASF	15014MASF		
M2.5 x 0.45	05252SF	15252SF	15252MASF	15252MASF	15252MASF	1000
	05253SF	15253SF	15253MASF	15253MASF		
	05254SF	15254SF	15254MASF	15254MASF		
	05255SF	15255SF	15255MASF	15255MASF		
M2.6 x 0.45	05262SF	15262SF	15262MASF	15262MASF	15262MASF	1000
	05263SF	15263SF	15263MASF	15263MASF		
	05264SF	15264SF	15264MASF	15264MASF		
	05265SF	15265SF	15265MASF	15265MASF		
M5 x 0.5	05032SF	15032SF	15032MASF	15032MASF	15032MASF	1000
	05033SF	15033SF	15033MASF	15033MASF		
M3.5 x 0.6	05352SF	15352SF	15352MASF	15352MASF	15352MASF	1000
	05353SF	15353SF	15353MASF	15353MASF		
	05354SF	15354SF	15354MASF	15354MASF		
	05355SF	15355SF	15355MASF	15355MASF		
M4 x 0.7	05042SF	15042SF	15042MASF	15042MASF	15042MASF	1000
	05062SF	15062SF	15062MASF	15062MASF		
M12 x 1.25	Upon Request	Upon Request	Upon Request	Upon Request	15062MASF	500
	Upon Request	Upon Request	Upon Request	Upon Request		
M12 x 1.5	Upon Request	Upon Request	Upon Request	Upon Request	15122MASF	125
	Upon Request	Upon Request	Upon Request	Upon Request		
	Upon Request	Upon Request	Upon Request	Upon Request		
M12 x 1.75	05122SF	15122SF	15122MASF	15122MASF	15122MASF	125
	05123SF	15123SF	15123MASF	15123MASF		
	05124SF	15124SF	15124MASF	15124MASF		

Recoil Inch Insert Part Number Call-Out and Dimensional Data

Thread Nominal UNC	Nominal Length Dia	Free Running Part Number	Screw Locking Part Number	Insert Length		Number of Coils	Free Coil Dia		BASIC LENGTH OF INSERT NOMINAL DIAMETER OF SCREW "D"			
				inches	mm		Min.	Max	Q	R	S	T
#2 - 56	1D	03522	13522	0.086	2.2	3.000			0.086	0.068	0.166	0.148
	1.5D	03523	13523	0.129	3.3	5.250	.110		0.129	0.111	0.209	0.191
	2D	03524	13524	0.172	4.4	7.375	.119		0.172	0.154	0.252	0.234
	2.5D	03525	13525	0.215	5.5	9.625			0.215	0.197	0.295	0.277
	3D	03526	13526	0.258	6.6	11.875			0.258	0.240	0.338	0.320
#3 - 48	1D	03532	13532	0.099	2.5	2.875			0.099	0.078	0.193	0.172
	1.5D	03533	13533	0.149	3.8	5.000	.128		0.148	0.127	0.242	0.221
	2D	03534	13534	0.198	5	7.250	.139		0.198	0.177	0.292	0.271
	2.5D	03535	13535	0.248	6.3	9.375			0.248	0.227	0.342	0.321
	3D	03536	13536	0.297	7.5	11.500			0.297	0.276	0.391	0.370
#4 - 40	1D	03542	13542	0.112	2.8	2.750			0.112	0.087	0.224	0.199
	1.5D	03543	13543	0.168	4.3	4.750	.144		0.168	0.143	0.28	0.255
	2D	03544	13544	0.224	5.7	6.750	.159		0.224	0.199	0.336	0.311
	2.5D	03545	13545	0.280	7.1	8.875			0.280	0.255	0.392	0.367
	3D	03546	13546	0.336	8.5	10.875			0.336	0.311	0.448	0.423
#5 - 40	1D	03552	13552	0.112	2.8	3.250			0.125	0.100	0.237	0.212
	1.5D	03553	13553	0.168	4.3	5.500	.158		0.187	0.162	0.300	0.275
	2D	03554	13554	0.224	5.7	7.750	.173		0.250	0.225	0.362	0.337
	2.5D	03555	13555	0.280	7.1	10.000			0.312	0.287	0.425	0.400
	3D	03556	13556	0.336	8.5	12.250			0.375	0.350	0.487	0.462
#6 - 32	1D	03562	13562	0.138	3.5	2.750			0.138	0.107	0.279	0.247
	1.5D	03563	13563	0.207	5.3	4.750	.178		0.207	0.176	0.348	0.316
	2D	03564	13564	0.276	7	6.875	.193		0.276	0.245	0.417	0.385
	2.5D	03565	13565	0.345	8.8	8.875			0.345	0.314	0.486	0.454
	3D	03566	13566	0.414	10.5	10.750			0.414	0.383	0.555	0.523
#8 - 32	1D	03582	13582	0.164	4.2	3.500			0.164	0.133	0.305	0.273
	1.5D	03583	13583	0.246	6.2	6.000	.205		0.246	0.215	0.387	0.355
	2D	03584	13584	0.328	8.3	8.375	.220		0.328	0.297	0.469	0.437
	2.5D	03585	13585	0.410	10.4	10.750			0.410	0.379	0.551	0.519
	3D	03586	13586	0.492	12.5	13.250			0.492	0.461	0.633	0.601
#10 - 24	1D	03602	13602	0.190	4.8	2.875			0.190	0.148	0.377	0.336
	1.5D	03603	13603	0.285	7.2	5.000	.244		0.285	0.243	0.472	0.431
	2D	03604	13604	0.380	9.7	7.125	.259		0.380	0.338	0.567	0.526
	2.5D	03605	13605	0.475	12.1	9.250			0.475	0.433	0.662	0.621
	3D	03606	13606	0.570	14.5	11.375			0.570	0.528	0.757	0.716
#12 - 24	1D	03622	13622	0.216	5.5	3.500			0.216	0.174	0.404	0.362
	1.5D	03623	13623	0.324	8.2	6.000	.270		0.324	0.282	0.512	0.470
	2D	03624	13624	0.432	11	8.375	.285		0.432	0.390	0.620	0.578
	2.5D	03625	13625	0.540	13.7	10.625			0.540	0.498	0.727	0.686
	3D	03626	13626	0.648	16.5	13.125			0.648	0.606	0.836	0.794
1/4-20	1D	03042	13042	0.250	6.4	3.375			0.250	0.200	0.475	0.425
	1.5D	03043	13043	0.375	9.5	5.750	.310		0.375	0.325	0.600	0.550
	2D	03044	13044	0.500	12.7	8.000	.330		0.500	0.450	0.725	0.675
	2.5D	03045	13045	0.625	15.9	10.375			0.625	0.575	0.850	0.800
	3D	03046	13046	0.750	19.1	12.750			0.750	0.700	0.975	0.925

Drill Depth: The minimum drilling depth "S" allows for one pitch chip clearance between the tip of the tap and the bottom of the drilled hole. "S" minimum allows for tap clearance, the maximum amount of insert set-down and countersink. Where a spiral pointed tap is used, the drill depths shown should be increased to allow for chip clearance.

Fitted Insert:

- R = Maximum length of engaged portion of screw when tang is removed.
- Q = Minimum full tapped thread length.
- T = Minimum tapping depth - including 3 1/2 threads of plug tap.
- S = Minimum drill depth - excluding point.

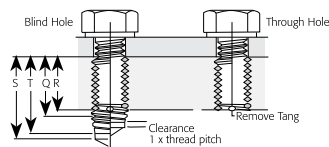

Note: Recoil metric inserts are made to Din locking torque requirements. Military specification MA parts need to be specifically ordered by adding MA to the standard part number above.

Note: Dimensions shown are for MA parts only.

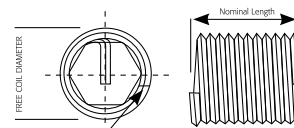

Recoil Inch Insert Part Number Call-Out and Dimensional Data

Thread Nominal UNC	Nominal Length Dia	Free Running Part Number	Screw Locking Part Number	Insert Length		Number of Coils	Free Coil Dia		BASIC LENGTH OF INSERT NOMINAL DIAMETER OF SCREW "D"			
				inches	mm		Min.	Max	Q	R	S	T
5/16-18	1D	03052	13052	0.313	8	4.000			0.312	0.257	0.562	0.507
	1.5D	03053	13053	0.470	11.9	6.625	.380		0.469	0.413	0.719	0.663
	2D	03054	13054	0.626	15.9	9.250	.400		0.625	0.569	0.875	0.819
	2.5D	03055	13055	0.783	19.9	11.875			0.781	0.726	1.031	0.976
	3D	03056	13056	0.939	23.9	14.625			0.937	0.882	1.187	1.132
3/8-16	1D	03062	13062	0.375	9.5	4.375			0.375	0.312	0.656	0.594
	1.5D	03063	13063	0.563	14.3	7.250	.452		0.562	0.500	0.844	0.781
	2D	03064	13064	0.750	19.1	10.000	.472		0.750	0.687	1.031	0.969
	2.5D	03065	13065	0.938	23.8	12.875			0.937	0.875	1.219	1.156
	3D	03066	13066	1.125	28.6	15.750			1.125	1.062	1.406	1.344
7/16-14	1D	03072	13072	0.438	11.1	4.500			0.437	0.366	0.759	0.687
	1.5D	03073	13073	0.657	16.7	7.375	.526		0.656	0.585	0.978	0.906
	2D	03074	13074	0.876	22.3	10.250	.551		0.875	0.804	1.196	1.125
	2.5D	03075	13075	1.095	27.8	13.125			1.094	1.022	1.415	1.343
	3D	03076	13076	1.314	33.4	16.125			1.312	1.241	1.634	1.562
1/2-13	1D	03082	13082	0.500	12.7	4.875			0.500	0.423	0.846	0.769
	1.5D	03083	13083	0.750	19.1	7.875	.597		0.750	0.673	1.096	1.019
	2D	03084	13084	1.000	25.4	11.000	.622		1.000	0.923	1.346	1.269
	2.5D	03085	13085	1.250	31.8	14.125			1.250	1.173	1.596	1.519
	3D	03086	13086	1.500	38.1	17.125			1.500	1.423	1.846	1.769
9/16-12	1D	03092	13092	0.563	14.3	5.125			0.562	0.479	0.937	0.854
	1.5D	03093	13093	0.845	21.5	8.250	.669		0.844	0.760	1.219	1.135
	2D	03094	13094	1.126	28.6	11.500	.694		1.125	1.042	1.500	1.417
	2.5D	03095	13095	1.408	35.8	14.750			1.406	1.323	1.781	1.698
	3D	03096	13096	1.689	42.9	17.125			1.687	1.604	2.062	1.979
5/8-11	1D	03102	13102	0.625	15.9	5.250			0.625	0.534	1.034	0.943
	1.5D	03103	13103	0.938	23.8	8.500	.742		0.937	0.846	1.347	1.256
	2D	03104	13104	1.250	31.8	11.750	.767		1.250	1.159	1.659	1.568
	2.5D	03105	13105	1.563	39.7	15.000			1.562	1.471	1.972	1.881
	3D	03106	13106	1.875	47.6	18.375			1.875	1.784	2.284	2.193
11/16-11	1D	03112	Upon Request	0.688	17.5	5.75			17.46	15.15	27.85	25.54
	1.5D	03113	Upon Request	1.032	26.2	9.80	.809		26.19	23.88	36.58	34.28
	2D	03114	Upon Request	1.376	35	12.95	.826		34.93	32.62	45.32	43.01
	2.5D	03115	Upon Request	1.720	43.7	16.55			43.66	41.35	54.05	51.74
	3D	03116	Upon Request	2.064	52.4	20.15			52.39	50.08	62.78	60.47
3/4-10	1D	03122	13122	0.750	19.1	5.875			0.750	0.650	1.200	1.100
	1.5D	03123	13123	1.125	28.6	9.375	.881		1.125	1.025	1.575	1.475
	2D	03124	13124	1.500	38.1	13.000	.906		1.500	1.400	1.950	1.850
	2.5D	03125	13125	1.875	47.6	16.500			1.875	1.775	2.325	2.225
	3D	03126	13126	2.250	57.2	20.125			2.250	2.150	2.700	2.600
7/8-9	1D	03142	13142	0.875	22.2	6.250			0.875	0.764	1.375	1.264
	1.5D	03143	13143	1.313	33.3	10.000	1.022		1.312	1.201	1.812	1.701
	2D	03144	13144	1.750	44.5	13.750	1.052		1.750	1.639	2.250	2.139
	2.5D	03145	13145	2.188	55.6	17.500			2.187	2.076	2.687	2.576
	3D	03146	13146	2.625	66.7	21.250			2.625	2.514	3.125	3.014

Drill Depth: The minimum drilling depth "S" allows for one pitch chip clearance between the tip of the tap and the bottom of the drilled hole. "S" minimum allows for tap clearance, the maximum amount of insert set-down and countersink. Where a spiral pointed tap is used, the drill depths shown should be increased to allow for chip clearance.

Fitted Insert:

- R = Maximum length of engaged portion of screw when tang is removed.
- Q = Minimum full tapped thread length.
- T = Minimum tapping depth - including 3 1/2 threads of plug tap.
- S = Minimum drill depth - excluding point.

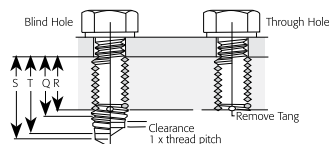

Note: Recoil metric inserts are made to Din locking torque requirements. Military specification MA parts need to be specifically ordered by adding MA to the standard part number above.

Note: Dimensions shown are for MA parts only.

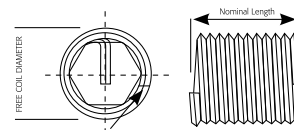

Recoil Inch Insert Part Number Call-Out and Dimensional Data

Thread Nominal UNC	Nominal Length Dia	Free Running Part Number	Screw Locking Part Number	Insert Length		Number of Coils	Free Coil Dia Min. Max	BASIC LENGTH OF INSERT NOMINAL DIAMETER OF SCREW "D"			
				inches	mm			Q	R	S	T
1" - 8	1D	03162	13162	1.000	25.4	6.375		1.000	0.875	1.563	1.437
	1.5D	03163	13163	1.500	38.1	10.125	1.166	1.500	1.375	2.062	1.937
	2D	03164	13164	2.000	50.8	14.000	1.196	2.000	1.875	2.562	2.437
	2.5D	03165	13165	2.500	63.5	17.750		2.500	2.375	3.062	2.937
	3D	03166	13166	3.000	76.2	21.625		3.000	2.875	3.562	3.437
1 1/8 - 7	1D	03182	13182	1.125	28.6	6.125		1.125	0.982	1.768	1.625
	1.5D	03183	13183	1.688	42.9	9.875	1.315	1.687	1.545	2.330	2.187
	2D	03184	13184	2.250	57.2	13.625	1.355	2.250	2.107	2.893	2.750
	2.5D	03185	13185	2.813	71.4	17.500		2.812	2.670	3.455	3.312
	3D	03186	13186	3.375	85.7	21.250		3.375	3.232	4.018	3.875
1 1/4 - 7	1D	03202	13202	1.250	31.8	7.000		1.250	1.107	1.893	1.750
	1.5D	03203	13203	1.875	47.6	11.250	1.443	1.875	1.732	2.518	2.375
	2D	03204	13204	2.500	63.5	15.375	1.483	2.500	2.357	3.143	3.000
	2.5D	03205	13205	3.125	79.4	19.500		3.125	2.982	3.768	3.625
	3D	03206	13206	3.750	95.3	23.750		3.750	3.607	4.393	4.250
1 3/8 - 6	1D	03222	13222	1.375	34.9	6.500		1.375	1.208	2.125	1.958
	1.5D	03223	13223	2.063	52.4	10.500	1.598	2.062	1.896	2.812	2.646
	2D	03224	13224	2.750	69.9	14.375	1.643	2.750	2.583	3.500	3.333
	2.5D	03225	13225	3.438	87.3	18.375		3.437	3.270	4.187	4.021
	3D	03226	13226	4.125	104.8	22.250		4.125	3.958	4.875	4.708
1 1/2 - 6	1D	03242	13242	1.500	38.1	7.250		1.500	1.333	2.250	1.083
	1.5D	03243	13243	2.250	57.2	11.500	1.727	2.250	2.083	3.000	2.833
	2D	03244	13244	3.000	76.2	15.875	1.772	3.000	2.833	3.750	3.583
	2.5D	03245	13245	3.750	95.3	20.125		3.750	3.583	4.500	4.333
	3D	03246	13246	4.500	114.3	24.500		4.500	4.333	5.250	5.083

Thread Nominal UNF	Nominal Length Dia	Part Number	Recoil Spec Free Running		MS Spec Free Running Screw Locking				Number of coils	Free Coil Dia Min/Max	BASIC LENGTH OF INSERT NOMINAL DIAMETER OF SCREW 'D'			
			Free Coil Dia Min/Max	Number of coils	Part Number	Part Number	Insert Length Inches mm	Q			R	S	T	
#3 - 56	1D	04532		3.60	04532MS	14532	0.099	2.5	3.375		0.099	0.081	0.179	0.161
	1.5D	04533		6.05	04533MS	14533	0.149	3.8	5.625	.131	0.148	0.130	0.228	0.210
	2D	04534	3.15 - 3.25	8.65	04534MS	14534	0.198	5	8.000	.146	0.198	0.180	0.278	0.260
	2.5D	04535		11.25	04535MS		0.248	6.3	10.375		0.248	0.230	0.328	0.310
	3D	04536		13.75	04536MS		0.297	7.5	12.625		0.297	0.279	0.377	0.359
#4 - 48	1D	04542		3.55	04542MS	14542	0.112	2.8	3.375		0.112	0.091	0.206	0.185
	1.5D	04543		5.95	04543MS	14543	0.168	4.3	5.625	.147	0.168	0.147	0.262	0.241
	2D	04544	3.57 - 3.67	8.25	04544MS	14544	0.224	5.7	7.875	.162	0.224	0.203	0.318	0.297
	2.5D	04545		10.95	04545MS		0.280	7.1	10.250		0.280	0.259	0.374	0.353
	3D	04546		13.35	04546MS		0.336	8.5	12.500		0.336	0.315	0.430	0.409
#6 - 40	1D	04562		3.55	04562MS	14562	0.138	3.5	3.500		0.138	0.113	0.250	0.225
	1.5D	04563		6.15	04563MS	14563	0.207	5.3	6.000	.173	0.207	0.182	0.319	0.294
	2D	04564	4.38 - 4.50	8.65	04564MS	14564	0.276	7	8.375	.193	0.276	0.251	0.388	0.363
	2.5D	04565		11.15	04565MS		0.345	8.8	10.750		0.345	0.320	0.457	0.432
	3D	04566		13.75	04566MS		0.414	10.5	13.250		0.414	0.389	0.526	0.501

Drill Depth: The minimum drilling depth "S" allows for one pitch chip clearance between the tip of the tap and the bottom of the drilled hole. "S" minimum allows for tap clearance, the maximum amount of insert set-down and countersink. Where a spiral pointed tap is used, the drill depths shown should be increased to allow for chip clearance.

Note: Recoil metric inserts are made to Din locking torque requirements. Military specification MA parts need to be specifically ordered by adding MA to the standard part number above.

Note: Dimensions shown are for MA parts only.

Fitted Insert:

R = Maximum length of engaged portion of screw when tang is removed.

Q = Minimum full tapped thread length.

T = Minimum tapping depth - including 3 1/2 threads of plug tap.

S = Minimum drill depth - excluding point.

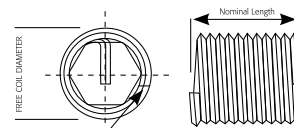
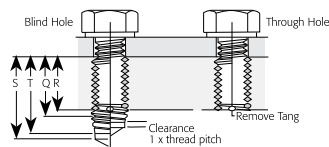

Recoil Inch Insert Part Number Call-Out and Dimensional Data

Thread Nominal UNF	Nominal Length Dia	Part Number	Recoil Spec		MS spec				BASIC LENGTH OF INSERT					
			Free Running Free Coil Dia Min/Max	Number of coils	Free running Part Number	Screw Locking Part Number	Insert Length Inches mm	Number of coils	FreeCoil Dia Min/Max	NOMINAL DIAMETER OF SCREW 'D'				
										Q	R	S	T	
#8 - 36	1D	04582	5.14 - 5.28	3.85	04582MS	14582	0.164	4.2	3.875	.204 .224	0.164	0.136	0.289	0.261
	1.5D	04583		6.85	04583MS	14583	0.246	6.2	6.500		0.246	0.218	0.371	0.343
	2D	04584		9.35	04584MS	14584	0.328	8.3	9.125		0.328	0.300	0.453	0.425
	2.5D	04585		11.95	04585MS		0.410	10.4	11.625		0.410	0.382	0.535	0.507
	3D	04586		14.65	04586MS		0.492	12.5	14.250		0.492	0.464	0.617	0.589
#10 - 32	1D	04602	5.85 - 6.00	4.25	04602MS	14602	0.190	4.8	4.125	.236 .256	0.190	0.159	0.331	0.299
	1.5D	04603		7.05	04603MS	14603	0.285	7.2	6.875		0.285	0.254	0.426	0.394
	2D	04604		9.95	04604MS	14604	0.380	9.7	9.500		0.380	0.349	0.521	0.489
	2.5D	04605		12.25	04605MS	14605	0.475	12.1	12.000		0.475	0.444	0.616	0.584
	3D	04606		15.65	04606MS	14606	0.570	14.5	14.875		0.570	0.539	0.711	0.679
#12 - 28	1D				04622MS		0.216	5.5	4.25	.265 .275	5.49	4.58	9.57	8.66
	1.5D				04623MS		0.324	8.2	7.30		8.23	7.32	12.31	11.40
	2D				04624MS	Upon Req.	0.432	11	9.85		10.97	10.07	15.05	14.15
	2.5D						0.540	13.7						
	3D						0.648	16.5						
1/4-28	1D	04042	7.60-7.80	5.05	04042MS	14042	0.250	6.4	5.000	.306 .326	0.250	0.214	0.411	0.375
	1.5D	04043		8.45	04043MS	14043	0.375	9.5	8.250		0.375	0.339	0.536	0.500
	2D	04044		11.65	04044MS	14044	0.500	12.7	11.375		0.500	0.464	0.661	0.625
	2.5D	04045		14.95	04045MS	14045	0.625	15.9	14.500		0.625	0.589	0.786	0.750
	3D	04046		18.15	04046MS	14046	0.750	19.1	17.625		0.750	0.714	0.911	0.875
5/16-24	1D	04052	9.45-9.65	5.55	04052MS	14052	0.313	8	5.500	.380 .400	0.312	0.271	0.500	0.458
	1.5D	04053		9.05	04053MS	14053	0.470	11.9	8.875		0.469	0.428	0.656	0.615
	2D	04054		12.55	04054MS	14054	0.626	15.9	12.250		0.625	0.583	0.812	0.771
	2.5D	04055		16.15	04055MS	14055	0.783	19.9	15.625		0.781	0.740	0.969	0.927
	3D	04056		19.65	04056MS	14056	0.939	23.9	19.000		0.937	0.896	1.125	1.083
3/8-24	1D	04062	11.00-11.20	7.05	04062MS	14062	0.375	9.5	6.875	.448 .468	0.375	0.333	0.562	0.521
	1.5D	04063		11.25	04063MS	14063	0.563	14.3	11.000		0.562	0.521	0.750	0.708
	2D	04064		15.45	04064MS	14064	0.750	19.1	15.000		0.750	0.708	0.937	0.896
	2.5D	04065		19.75	04065MS	14065	0.938	23.8	19.125		0.937	0.896	1.125	1.083
	3D	04066		23.95	04066MS	14066	1.125	28.6	23.125		1.125	1.083	1.312	1.271
7/16-20	1D	04072	12.96-13.20	6.85	04072MS	14072	0.438	11.1	6.625	.524 .549	0.437	0.387	0.662	0.612
	1.5D	04073		11.05	04073MS	14073	0.657	16.7	10.625		0.656	0.606	0.881	0.831
	2D	04074		15.25	04074MS	14074	0.876	22.3	14.625		0.875	0.825	1.100	1.050
	2.5D	04075		19.75	04075MS	14075	1.095	27.8	18.500		1.094	1.044	1.319	1.269
	3D	04076		23.45	04076MS	14076	1.314	33.4	22.500		1.312	1.262	1.537	1.488
1/2-20	1D	04082	14.60-14.90	8.05	04082MS	14082	0.500	12.7	7.875	.592 .617	0.500	0.450	0.725	0.675
	1.5D	04083		12.75	04083MS	14083	0.750	19.1	12.375		0.750	0.700	0.975	0.925
	2D	04084		17.45	04084MS	14084	1.000	25.4	16.875		1.000	0.950	1.225	1.175
	2.5D	04085		22.05	04085MS	14085	1.250	31.8	21.375		1.250	1.200	1.475	1.425
	3D	04086		26.75	04086MS	14086	1.500	38.1	25.875		1.500	1.450	1.725	1.675
9/16-18	1D	04092	16.38-16.68	8.15	04092MS	14092	0.563	14.3	8.000	.666 .691	0.562	0.507	0.812	0.757
	1.5D	04093		12.85	04093MS	14093	0.845	21.5	12.500		0.844	0.788	1.094	1.038
	2D	04094		17.65	04094MS	14094	1.126	28.6	17.125		1.125	1.068	1.375	1.319
	2.5D	04095		22.45	04095MS	14095	1.408	35.8	21.750		1.406	1.351	1.656	1.601
	3D	04096		27.15	04096MS	14096	1.689	42.9	26.250		1.687	1.632	1.937	1.882

Drill Depth: The minimum drilling depth "S" allows for one pitch chip clearance between the tip of the tap and the bottom of the drilled hole. "S" minimum allows for tap clearance, the maximum amount of insert set-down and countersink. Where a spiral pointed tap is used, the drill depths shown should be increased to allow for chip clearance.

Fitted Insert:

- R = Maximum length of engaged portion of screw when tang is removed.
- Q = Minimum full tapped thread length.
- T = Minimum tapping depth - including 3 1/2 threads of plug tap.
- S = Minimum drill depth - excluding point.

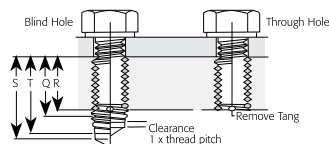

Note: Recoil metric inserts are made to Din locking torque requirements. Military specification MA parts need to be specifically ordered by adding MA to the standard part number above.

Note: Dimensions shown are for MA parts only.

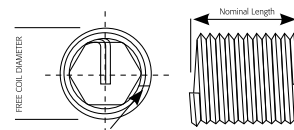

Recoil Inch Insert Part Number Call-Out and Dimensional Data

Thread Nominal UNF	Nominal Length Dia	Part Number	Recoil Spec		MS spec				BASIC LENGTH OF INSERT					
			Free Running Free Coil Dia Min/Max	Number of coils	Free running Part Number	Screw Locking Part Number	Insert Length Inches mm	Number of coils	FreeCoil Dia Min/Max	NOMINAL DIAMETER OF SCREW 'D'				
										Q	R	S	T	
5/8-18	1D	04102	18.00-18.30	9.25	04102MS	14102	0.625	15.9	9.000	0.625	0.569	0.875	0.819	
	1.5D	04103		14.55	04103MS	14103	0.938	23.8	14.125	.733	0.937	0.882	1.187	1.132
	2D	04104		20.05	04104MS	14104	1.250	31.8	19.250	.758	1.250	1.194	1.500	1.444
	2.5D	04105		25.05	04105MS	14105	1.563	39.7	24.250		1.562	1.507	1.812	1.757
	3D	04106		30.45	04106MS	14106	1.875	47.6	29.375		1.875	1.819	2.125	2.069
3/4-16	1D	04122	21.20-21.60	9.95	04122MS	14122	0.750	19.1	9.750	0.750	0.687	1.031	0.969	
	1.5D	04123		15.55	04123MS	14123	1.125	28.6	15.125	.876	1.125	1.062	1.406	1.344
	2D	04124		21.35	04124MS	14124	1.500	38.1	20.625	.901	1.500	1.437	1.781	1.719
	2.5D	04125		26.85	04125MS	14125	1.875	47.6	26.000		1.875	1.812	2.156	2.094
	3D	04126		32.65	04126MS	14126	2.250	57.2	31.500		2.250	2.187	2.531	2.469
7/8-14	1D	04142	24.97 - 25.33	10.15	04142MS	14142	0.875	22.2	9.875	0.875	0.804	1.196	1.125	
	1.5D	04143		16.15	04143MS	14143	1.313	33.3	15.500	1.021	1.312	1.241	1.634	1.562
	2D	04144		22.05	04144MS	14144	1.750	44.5	21.125	1.051	1.750	1.679	2.071	2.000
	2.5D	04145		27.85	04145MS	14145	2.188	55.6	26.625		2.187	2.116	2.509	2.437
	3D	04146		33.75	04146MS	14146	2.625	66.7	32.250		2.625	2.554	2.946	2.875
1" - 12	1D	04162	28.47 - 28.83	9.95	04162MS	14162	1.000	25.4	9.625	1.000	0.917	1.375	1.292	
	1.5D	04163		15.65	04163MS	14163	1.500	38.1	15.000	1.169	1.500	1.417	1.875	1.792
	2D	04164		21.35	04164MS	14164	2.000	50.8	20.500	1.199	2.000	1.917	2.375	2.292
	2.5D	04165		27.15	04165MS	14165	2.500	63.5	26.000		2.500	2.417	2.875	2.792
	3D	04166		32.95	04166MS	14166	3.000	76.2	31.500		3.000	2.917	3.375	3.292
1" - 14	1D	04162-14	28.07 - 28.43	11.95	04162-14MS	14162-14	8.364	25.4	11.500	25.40	23.59	33.56	31.75	
	1.5D	04163-14		18.55	04163-14MS	14163-14	9.641	38.1	17.875	1.156	38.10	36.29	46.26	44.45
	2D	04164-14		25.05	04164-14MS	14164-14	11.059	50.8	24.250	1.186	50.80	48.99	58.96	57.15
	2.5D	04165-14		31.75	04165-14MS	14165-14	13.043	63.5	30.625		63.50	61.69	71.66	69.85
	3D	04166-14		38.35	04166-14MS	14166-14	14.745	76.2	37.000		76.20	74.39	84.36	82.55
1 1/8 - 12	1D	04182	31.72 - 32.10	11.55	04182MS	14182	1.125	28.6	11.125	1.125	1.042	1.500	1.417	
	1.5D	04183		17.95	04183MS	14183	1.688	42.9	17.250	1.304	1.687	1.604	2.062	1.979
	2D	04184		24.35	04184MS	14184	2.250	57.2	23.375	1.334	2.250	2.167	2.625	2.542
	2.5D	04185		30.85	04185MS	14185	2.813	71.4	29.500		2.812	2.729	3.187	3.104
	3D	04186		37.35	04186MS	14186	3.375	85.7	35.750		3.375	3.292	3.750	3.667
1 1/4 - 12	1D	04202	34.90 - 35.30	12.95	04202MS	14202	1.250	31.8	12.500	1.250	1.167	1.625	1.542	
	1.5D	04203		20.15	04203MS	14203	1.875	47.6	19.375	1.439	1.875	1.792	2.250	2.167
	2D	04204		27.45	04204MS	14204	2.500	63.5	26.250	1.469	2.500	2.417	2.875	2.792
	2.5D	04205		34.55	04205MS	14205	3.125	79.4	33.000		3.125	3.042	3.500	3.417
	3D	04206		41.75	04206MS	14206	3.750	95.3	39.875		3.750	3.667	4.125	4.042
1 3/8 - 12	1D	04222	38.22 - 38.52	14.25	04222MS	14222	1.375	34.9	13.750	1.375	1.292	1.750	1.667	
	1.5D	04223		22.25	04223MS	14223	2.063	52.4	21.375	1.575	2.062	1.979	2.437	2.354
	2D	04224		30.15	04224MS	14224	2.750	69.9	28.875	1.610	2.750	2.667	3.125	3.042
	2.5D	04225		38.15	04225MS		3.438	87.3	36.500		3.437	3.354	3.812	3.729
	3D			46.05					44.000		4.125	4.042	4.500	4.417
1 1/2 - 12	1D	04242	41.38 - 41.78	15.85	04242MS	14242	1.500	38.1	15.250	1.500	1.417	1.875	1.792	
	1.5D	04243		24.55	04243MS	14243	2.250	57.2	23.500	1.710	2.250	2.167	2.625	2.542
	2D	04244		33.05	04244MS	14244	3.000	76.2	31.625	1.745	3.000	2.917	3.375	3.292
	2.5D	04245		41.75	04245MS	14245	3.750	95.3	39.875		3.750	3.667	4.125	4.042
	3D	04246		50.35	04246MS	14246	4.500	114.3	48.125		4.500	4.417	4.875	4.792

Drill Depth: The minimum drilling depth "S" allows for one pitch chip clearance between the tip of the tap and the bottom of the drilled hole. "S" minimum allows for tap clearance, the maximum amount of insert set-down and countersink. Where a spiral pointed tap is used, the drill depths shown should be increased to allow for chip clearance.

Fitted Insert:

- R = Maximum length of engaged portion of screw when tang is removed.
- Q = Minimum full tapped thread length.
- T = Minimum tapping depth - including 3 1/2 threads of plug tap.
- S = Minimum drill depth - excluding point.

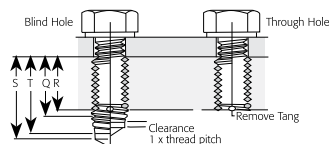

Note: Recoil metric inserts are made to Din locking torque requirements. Military specification MA parts need to be specifically ordered by adding MA to the standard part number above.

Note: Dimensions shown are for MA parts only.

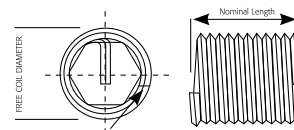

Recoil Strip Feed Part Number Call-Out and Dimensional Data

Magazined on Reels Dia 200				Magazined on Reels Dia 290		
Thread Nominal Free Running	Strip Feed Part Number Locking	Strip Feed Part Number	No. of Inserts	Strip Feed Part Number Free Running	Strip Feed Part Number Locking	No. of Inserts
#2-56	03522SF	13522SF	1000	03525SF 03526SF	13525SF 13526SF	1000 1000
	03523SF	13523SF	1000			
	03524SF	13524SF	1000			
#3-56	03532SF		1000	03535SF 03536SF	13535SF 13536SF	1000 1000
	03533SF		1000			
	03534SF		1000			
#4-40	03542SF	13542SF	1000	03544SF 03545SF 03546SF	13544SF 13545SF 13546SF	1000 1000 1000
	03543SF	13543SF	1000			
#5-40	03552SF	13552SF	1000	03555SF 03556SF	13555SF 13556SF	1000 1000
	03553SF	13553SF	1000			
	03554SF	13554SF	1000			
#6-32	03562SF	13562SF	1000	03563SF 03564SF 03565SF 03566SF	13563SF 13564SF 13565SF 13566SF	1000 1000 1000 1000
#8-32				03582SF 03583SF 03584SF 03585SF 03586SF	13582SF 13583SF 13584SF 13585SF 13586SF	1000 1000 1000 500 500
#10-24				03602SF 03603SF 03604SF 03605SF 03606SF	13602SF 13603SF 13604SF 13605SF 13606SF	1000 500 500 500 500
#12-24				03622SF 03623SF 03624SF 03625SF 03626SF	13622SF 13623SF 13624SF 13625SF 13626SF	1000 500 500 500 500
1/4-20				03042SF 03043SF 03044SF 03045SF 03046SF	13042SF 13043SF 13044SF 13045SF 13046SF	500 500 250 250 250
5/16-18				03052SF 03053SF 03054SF	13052SF 13053SF 13054SF	250 250 250
3/8-16				03062SF 03063SF 03064SF	13062SF 13063SF 13064SF	250 250 250

Recoil Strip Feed Part Number Call-Out and Dimensional Data

Magazined on Reels Dia 200				Magazined on Reels Dia 290			
Thread Nominal Free Running	Strip Feed Part Number Locking	Strip Feed Part Number	No. of Inserts	Strip Feed Part Number Free Running	Strip Feed Part Number Locking	No. of Inserts	
7/16-14				03072SF	13062SF	125	
				03073SF	13063SF	125	
1/4-28				04042SF	14042SF	500	
				04043SF	14043SF	500	
				04044SF	14044SF	500	
				04045SF	14045SF	250	
				04046SF	14046SF	250	
				04052SF	14052SF	250	
5/16-24				04053SF	14053SF	250	
				04054SF	14054SF	250	
				04055SF	14055SF	250	
				04056SF	14056SF	250	
	3/8-24				04062SF	14062SF	250
					04063SF	14063SF	250
				04064SF	14064SF	250	
				04065SF	14065SF	250	
				04066SF	14066SF	250	
				04602SF	14602SF	1000	
#10-32				04603SF	14603SF	500	
				04604SF	14604SF	500	
				04605SF	14605SF	500	
				04606SF	14606SF	500	
	#12-28				04622SF	14622SF	1000
					04623SF	14623SF	1000
				04624SF	14624SF	1000	
				04625SF	14625SF	500	
				04626SF	14626SF	500	
#3 - 56		04532SF	14532SF	1000	04534SF	14534SF	1000
	04533SF	14533SF	1000	04535SF	14535SF	1000	
				04536SF	14536SF	1000	
#4 - 48	04542SF	14542SF	1000	04544SF	14544SF	1000	
	04543SF	14543SF	1000	04545SF	14545SF	1000	
				04546SF	04546SF	1000	
#6 - 40	04562SF	14562SF	1000	04564SF	14564SF	1000	
	04563SF	14563SF	1000	04565SF	14565SF	1000	
				04566SF	14566SF	1000	
#8 - 36				04582SF	14582SF	1000	
				04583SF	14583SF	1000	
				04584SF	14584SF	500	
				04585SF	14585SF	500	
				04586SF	14586SF	500	

STI Taps

Recoil Insert Taps

Recoil taps differ from standard taps dimensionally and only Recoil Screw Thread Insert (STI) Taps are suitable for use with Recoil Wire Thread Inserts. Recoil taps are manufactured to precise standards from either High Speed Steel (HSS) with ground threads and are available with taper, intermediate, and bottoming leads. They have a larger diameter but the same pitch as a standard tap in order to accommodate the wire insert. Spiral point and spiral flute machine taps are also available for volume production purposes. For all sparkplug applications, pilot nose taps are recommended and are available for common metric thread sizes. The Recoil thread insert when installed into a correctly tapped hole will provide the applicable internal thread tolerance for the installed bolt.

Note: Tapped hole size can be significantly affected by variations in drill size, parent material, or lubricant so in close tolerance applications some testing for an optimum combination is recommended.

Thread Class

Unified Thread Class

In the unified thread system, the minimum pitch diameter for a 2B hole (medium fit) or 3B hole (close fit) are the same, while the maximum pitch diameter is greater on the 2B hole (medium fit). Recoil taps for unified threads are made to a 3B hole (close fit) tolerance.

Metric Thread Class

In the metric thread system the minimum pitch diameter for a 5H hole (medium fit) or 4H5H hole (close fit) are the same, while the maximum pitch diameter is greater on the 5H hole (medium fit). Recoil taps for metric threads are made to 4H5H hole (close fit) tolerance.

Metric thread tolerance equivalents standards		
	Standards	Recoil Standards
Medium	Metric 6H	5H
Close	Metric 5H	4H5H

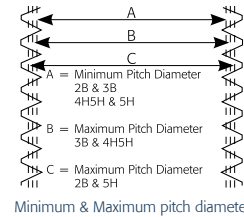

Taper

Taper (or Roughing Taps) are used for starting precision and difficult holes. This tap has a lead of eight threads, but no size reduction.



Intermediate

Intermediate (or Plug/Second), used in most general purpose applications to facilitate thread cutting true to the drilled hole. The tap has a lead of four threads, but no size reduction.



Bottoming

Bottoming Taps are used to ensure the minimum thread run-out when tapping to the bottom of blind holes. The tap has a lead of two threads and would normally be preceded by a taper or an intermediate tap.



Pilot Nose

Pilot nose taps have been developed for repairing damaged threads without the need for drilling prior to tapping. This style of tap allows the use of the existing thread as a guide in tapping a straight hole. This style of tap is widely used in repairing damaged spark plug threads.



Spiral Flute

Spiral Flute taps are recommended for machine tapping for all blind hole applications, particularly in soft materials such as copper, magnesium and aluminium which produce long stringy swarf.



Spiral Point

Spiral Point Taps are recommended for machine tapping through holes. These taps provide for chip clearance within the lead of the tap.



Thredflo 'Roll Thread' Taps

These taps are designed for machine tapping in ductile materials with higher elasticity e.g. materials with a low silicon content, aluminium & some stainless steels. This tap is designed without flutes or cutting faces, but with special roll forming lobes. It has short tapered leads for through or blind holes and is made from HSS.



STI Taps

Tap Type and Applications

The most commonly used type of Recoil taps are defined together with their typical applications. The Taper, Intermediate, and Bottoming are short machine taps (suitable for hand tapping), while the Spiral Point and Spiral Flute are used in production applications.

Surface Coatings

Recoil taps can be supplied in different surface coatings for special order requirements. Benefits of surface coatings include:

- Longer tool life
- Increased productivity
- Tools can be run at higher feeds and speeds
- Lower maintenance costs

Titanium Carbonitride - TiCNite (TiCN)

TiCNite coated taps have a very high surface hardness and are generally tougher than other coating materials. It has a high resistance to edge chipping.

Titanium Nitride - TiNite (TiN)

TiNite coating is a good choice for protecting the tap. It can achieve a longer life than uncoated taps and can be used at higher speeds.

Chromium Nitride (CrN)

This PVD coating was developed for use in non-ferrous areas where titanium based coatings were not successful. It is recommended for the machining and forming of titanium and copper and is harder than conventional chrome plating. The PVD coating process has no environmental side effects.

Recoil Tap Part Numbering System

The system of identification used for Recoil taps is categorized into two primary sections: inch threads and metric threads. The tap annotation for both thread designations is very similar and therefore easy to follow.

Tap Part Number	4	3	04	5
	Product	Thread Type	Thread Size	Tap Style
Inch Series	4 = Tap	3 = UNC 4 = UNF	Diameter in 1/16" 04 = 1/4"	4 = taper 5 = intermediate 6 = bottoming 7 = pilot nose 8 = spiral point 9 = spiral flute 0 = roll form
Metric Series		5 = Coarse 7 = Medium 8 = Extra Fine	04 = 4mm	4 = taper 5 = intermediate 6 = bottoming 7 = pilot nose 8 = spiral point 9 = spiral flute 0 = roll form

Screw Pitch Gauge

It is critical that inserts match the tapped hole exactly as some inch and metric are very close but only one is exactly right. A screw pitch gauge is the perfect tool to identify exact TPI or pitch. The bolt diameter should be measured and matched to the closest size over, relating to the TPI or pitch of the thread. In general, major diameter of bolt or male thread will always be slightly less than the exact diameter listed in the thread identification and drill chart.

Recoil Tap Part Numbers and Dimensional Data Metric Thread Series

Thread Size	TAPER	INTERMEDIATE	BOTTOMING	SPIRAL POINT	SPIRAL FLUTE	OVERALL LENGTH	THREAD LENGTH	SHANK DIAMETER	SQUARE DRIVE
M2 x 0.4	45024	45025	45026	45028	45029	45	10	2.80	2.24
M2.2 x 0.45	45014	45015	45016	45018	45019	48	11	3.15	2.50
M2.5 x 0.45	45254	45255	45256	45258	45259	48	11	3.15	2.50
M3 x 0.5	45034	45035	45036	45038	45039	50	13	3.55	2.80
M3.5 x 0.6	45354	45355	45356	45358	45359	53	13	4.50	3.55
M4 x 0.7	45044	45045	45046	45048	45049	58	16	5.00	4.00
M5 x 0.8	45054	45055	45056	45058	45059	66	19	6.30	5.00
M6 x 1	45064	45065	45066	45068	45069	72	22	8.00	6.30
M7 x 1	45074	45075	45076	-	-	72	22	9.00	7.10
M8 x 1.25	45084	45085	45086	45088	45089	80	24	10.00	8.00
M9 x 1.25	45094	45095	45096	-	-	85	25	8.00	6.30
M10 x 1.5	45104	45105	45106	45108	45109	89	29	9.00	7.10
M11 x 1.5	45114	45115	45116	-	-	89	29	9.00	7.10
M12 x 1.75	45124	45125	45126	45128	45129	95	30	11.20	9.00
M14 x 2	45144	45145	45146	-	-	102	32	12.50	10.00
M15 x 2	45154	45155	45156	-	-	112	37	14.00	11.20
M16 x 2	45164	45165	45166	45168	45169	112	37	14.00	11.20
M18 x 2.5	45184	45185	45186	-	-	118	38	16.00	12.50
M20 x 2.5	45204	45205	45206	-	-	130	45	18.00	14.00
M22 x 2.5	45224	45225	45226	-	-	135	48	20.00	16.00
M24 x 3	45244	45245	45246	-	-	135	48	20.00	16.00
M27 x 3	45274	45275	45276	-	-	151	51	22.40	18.00
M30 x 3.5	45304	45305	45306	-	-	162	57	25.00	20.00
M30 x 3	45304-3	45305-3	45306-3	-	-	162	57	25.00	20.00
M33 x 3.5	45334	45335	45336	-	-	170	60	28.00	22.40
M36 x 4	45364	45365	45366	-	-	170	60	28.00	22.40
M39 x 4	45394	45395	45396	-	-	187	67	31.50	25.00
M42 x 4.5	45424	45425	45426	-	-	187	67	31.50	25.00
M42 X 4	45424-4	45425-4	45426-4	-	-	200	70	35.50	28.00
M52 X 5	45524	45525	45526	-	-	221	76	40.00	31.50

METRIC MEDIUM & FINE

M8 X 1	47084	47085	47086	-	-	80	24	10.00	8.00
M9 X 1	47094	47095	47096	-	-	85	25	8.00	6.30
M10 X 1.25	47104	47105	47106	47108	47109	85	25	9.00	7.10
M10 X 1	48104	48105	48106	48108	48109	85	25	8.00	6.30
M11 x 1.25	47114	47115	47116	-	-	89	29	9.00	7.10
M11 x 1	48114	48115	48116	-	-	89	29	9.00	7.10
M12 x 1.5	47124	47125	47126	-	-	95	30	11.20	9.00
M12 x 1.25	48124	48125	48126	-	-	95	30	11.20	9.00
M14 x 1.5	47144	47145	47146	-	-	102	32	12.50	10.00
M14 x 1.25	48144	48145	48146	-	-	102	32	12.50	10.00
M15 x 1.5	47154	47155	47156	-	-	112	37	14.00	11.20
M16 x 1.5	47164	47165	47166	-	-	112	37	14.00	11.20
M18 x 2	47184	47185	47186	-	-	112	37	14.00	11.20
M18 x 1.5	48184	48185	48186	-	-	112	37	14.00	11.20
M20 x 2	47204	47205	47206	-	-	118	38	16.00	12.50
M20 x 1.5	48204	48205	48206	-	-	118	38	16.00	12.50
M22 x 2	47224	47225	47226	-	-	130	45	18.00	14.00
M22 x 1.5	48224	48225	48226	-	-	130	45	18.00	14.00
M24 x 2	47244	47245	47246	-	-	135	48	20.00	16.00
M24 x 1.5	48244	48245	48246	-	-	135	48	20.00	16.00

Note: The Taps listed above represent the most popular of the Recoil Taps available. Other sizes and types are available including BSF, BSW, NPT, BA, 8UN ETC. Note: Tap dimensions based upon international (ISO) standard

Recoil Tap Part Numbers and Dimensional Data UNC, UNF

Thread Size UNC	TAPER	INTERMEDIATE	BOTTOMING	SPIRAL POINT	SPIRAL FLUTE	OVERALL LENGTH	THREAD LENGTH	SHANK DIAMETER	SQUARE DRIVE
2-56	43524	43525	43526	43528	43529	1.875	0.562	0.141	0.110
3-48	43534	43535	43536	43538	43539	1.937	0.625	0.141	0.110
4-40	43544	43545	43546	43548	43549	2.000	0.687	0.141	0.110
5-40	43554	43555	43556	43558	43559	2.125	0.750	0.168	0.131
6-32	43564	43565	43566	43568	43569	2.375	0.875	0.194	0.152
8-32	43584	43585	43586	43588	43589	2.375	0.937	0.220	0.165
10-24	43604	43605	43606	43608	43609	2.500	1.000	0.255	0.191
12-24	43624	43625	43626	43628	43629	2.718	1.125	0.318	0.238
1/4-20	43044	43045	43046	43048	43049	2.718	1.125	0.318	0.238
5/16-18	43054	43055	43056	43058	43059	2.937	1.250	0.381	0.286
3/8-16	43064	43065	43066	43068	43069	3.375	1.656	0.367	0.275
7/16-14	43074	43075	43076	43078	43079	3.593	1.656	0.429	0.322
1/2-13	43084	43085	43086	43088	43089	3.812	1.812	0.480	0.360
9/16-12	43094	43095	43096	43098	43099	4.031	1.812	0.542	0.406
5/8-11	43104	43105	43106	43108	43109	4.250	2.000	0.590	0.442
3/4-10	43124	43125	43126	43128	43129	4.687	2.218	0.697	0.523
7/8-9	43144	43145	43146	43148	43149	5.125	2.500	0.800	0.600
1-8	43164	43165	43166	43168	43169	5.750	2.562	1.021	0.766
11/8-7	43184	43185	43186	-	-	-	-	-	-
11/4-7	43204	43205	43206	-	-	-	-	-	-
13/8-6	43224	43225	43226	-	-	-	-	-	-
11/2-6	43244	43245	43246	-	-	-	-	-	-

UNF									
3-56	44534	44535	44536	44538	44539	1.937	0.625	0.141	0.110
4-48	44544	44545	44546	44548	44549	2.000	0.687	0.141	0.110
6-40	44564	44565	44566	44568	44569	2.125	0.750	0.168	0.131
8-36	44584	44585	44586	44588	44589	2.375	0.937	0.220	0.165
10-32	44604	44605	44606	44608	44609	2.500	1.000	0.255	0.191
12-28	44624	44625	44626	-	-	2.718	1.125	0.318	0.238
1/4-28	44044	44045	44046	44048	44049	2.718	1.125	0.318	0.238
5/16-24	44054	44055	44056	44058	44059	2.937	1.250	0.381	0.286
3/8-24	44064	44065	44066	44068	44069	3.156	1.438	0.323	0.242
7/16-20	44074	44075	44076	44078	44079	3.375	1.656	0.367	0.275
1/2-20	44084	44085	44086	44088	44089	3.593	1.656	0.429	0.322
9/16-18	44094	44095	44096	44098	44099	3.812	1.812	0.480	0.360
5/8-18	44104	44105	44106	44108	44109	4.031	1.812	0.542	0.406
3/4-16	44124	44125	44126	44128	44129	4.468	2.000	0.652	0.489
7/8-14	44144	44145	44146	44148	44149	5.125	2.500	0.800	0.600
1-12	44164	44165	44166	44168	44169	5.437	2.562	0.896	0.672
1-14	44164-14	44165-14	44166-14	44168-14	44169-14	5.437	2.562	0.896	0.672
11/8-12	44184	44185	44186	-	-	-	-	-	-
11/4-12	44204	44205	44206	-	-	-	-	-	-
13/8-12	44224	44225	44226	-	-	-	-	-	-
11/2-12	44244	44245	44246	-	-	-	-	-	-

Note: Tap dimensional data are based on American Standards (ANSI)

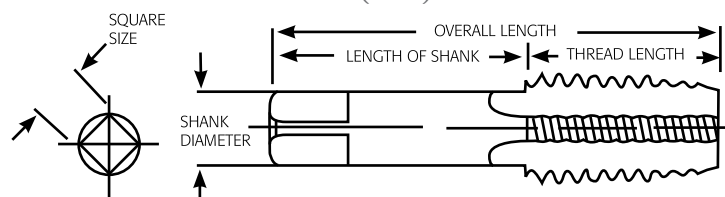

Recoil Tap Part Numbers and Dimensional Data BA, BSC, BSF, BSW

	TAPER	INTERMEDIATE	BOTTOMING	SPIRAL POINT	SPIRAL FLUTE	OVERALL LENGTH	THREAD LENGTH	SHANK DIAMETER	SQUARE DRIVE
BA									
0 BA	40504	40505	40506	-	-	72.00	22.00	8.00	6.30
1BA	40514	40515	40516	-	-	66.00	19.00	6.30	5.00
2 BA	40524	40525	40526	-	-	66.00	19.00	6.30	5.00
4 BA	40544	40545	40546	-	-	53.00	13.00	4.50	3.55
6 BA	40564	40565	40566	-	-	50.00	13.00	3.55	2.80

BSC									
5/16 - 26	46504	46505	46506	-	-	73.000	22.000	9.000	7.100
3/8 - 26	46604	46605	46606	-	-	85.000	25.000	8.000	6.300
7/16 - 26	46704	46705	46706	-	-	89.000	29.000	9.000	7.100
1/2 - 26	46804	46805	46806	-	-	95.000	30.000	11.200	9.000

BSF									
3/16 - 32	40034	40035	40036	-	-	67.00	19.00	6.30	5.00
1/4 - 26	40044	40045	40056	-	-	72.00	22.00	8.00	6.30
5/16 - 22	40054	40055	40056	-	-	80.00	24.00	8.00	6.30
3/8 - 20	40064	40065	40066	-	-	85.00	25.00	8.00	6.30
7/16 - 18	40074	40075	40076	-	-	89.00	29.00	9.00	7.10
1/2 - 16	40084	40085	40086	-	-	95.00	30.00	11.20	9.00
9/16 - 16	40094	40095	40096	-	-	102.00	32.00	12.50	10.00
5/8 - 14	40104	40105	40106	-	-	112.00	37.00	14.00	11.20
3/4 - 12	40124	40125	40126	-	-	118.00	38.00	16.00	12.50
7/8 - 11	40144	40145	40146	-	-	135.00	48.00	20.00	16.00
1 - 10	40164	40165	40166	-	-	135.00	48.00	20.00	16.00
1 1/4 - 9	40184	40185	40186	-	-	151.00	51.00	22.40	18.00

BSP									
1/8 - 28	41024	41025	41026	-	-	85.00	25.00	8.00	6.30
1/4 - 19	41044	41045	41046	-	-	95.00	30.00	11.20	9.00
3/8 - 19	41064	41065	41066	-	-	112.00	37.00	14.00	11.20
1/2 - 14	41084	41085	41086	-	-	130.00	45.00	18.00	14.00
5/8 - 14	41104	41105	41106	-	-	130.00	42.00	18.00	14.00
3/4 - 14	41124	41125	41126	-	-	135.00	48.00	20.00	16.00
1 - 11	41164	41165	41166	-	-	162.00	57.00	25.00	20.00

BSW									
1/8 - 40	42024	42025	42026			53.00	13.00	4.00	3.15
3/16-24	42034	42035	42036	42038	42039	67.00	19.00	6.30	5.00
1/4 - 20	42044	42045	42046	42048	42049	72.00	22.00	8.00	6.30
5/16-18	42054	42055	42056	42058	42059	80.00	24.00	10.00	8.00
3/8 - 16	42064	42065	42066	42068	42069	85.00	25.00	8.00	6.30
7/16-14	42074	42075	42076	-	-	95.00	30.00	11.20	9.00
1/2 - 12	42084	42085	42086	-	-	95.00	30.00	11.20	9.00
9/16-12	42094	42095	42096	-	-	102.00	32.00	12.50	10.00
5/8 - 11	42104	42105	42106	-	-	112.00	37.00	14.00	11.20
3/4 - 10	42124	42125	42126	-	-	118.00	38.00	16.00	12.50
7/8 - 9	42144	42145	42146	-	-	135.00	48.00	20.00	16.00
1 - 8	42164	42165	42166	-	-	135.00	48.00	20.00	16.00
1 1/8 - 7	42184	42185	42186	-	-	151.00	51.00	22.40	18.00
1 1/4 - 7	42204	42205	42206	-	-	162.00	57.00	25.00	20.00
1 3/8 - 6	42224	42225	42226	-	-	170.00	60.00	28.00	22.40
1 1/2 - 6	42244	42245	42246	-	-	187.00	67.00	31.50	25.00

Recoil Tap Part Numbers and Dimensional Data Unified Thread Series

	TAPER	INTERMEDIATE	BOTTOMING	SPIRAL POINT	SPIRAL FLUTE	OVERALL LENGTH	THREAD LENGTH	SHANK DIAMETER	SQUARE DRIVE
NPT									
1/8 - 27	46025	46026	-	-	-	2 1/8	3/4	0.438	0.328
1/4 - 18	46045	46046	-	-	-	2 7/16	1 1/16	0.563	0.420
3/8 - 18	46065	46066	-	-	-	2 9/16	1 1/6	0.700	0.531
1/2 - 14	46085	46086	-	-	-	3 5/32	1 3/8	0.687	0.515
3/4 - 14	46125	46126	-	-	-	3 9/32	1 3/8	0.906	0.679
1 - 11 1/2	46165	46166	-	-	-	3 3/4	4 3/4	1.125	0.893

8 TPI UN									
1 1/8 - 8	46184	46185	46186	—	—	5.945	2.007	0.881	0.708
1 1/4 - 8	46204	46205	46206	—	—	6.378	2.244	0.984	0.787
1 3/8 - 8	46224	46225	46226	—	—	6.692	2.362	1.102	0.881
1 1/2 - 8	46244	46245	46246	—	—	6.692	2.362	1.102	0.881
1 5/8 - 8	46264	46265	46266	—	—	7.362	2.637	1.240	0.984
1 3/4 - 8	46284	46285	46286	—	—	7.362	2.637	1.240	0.984
1 7/8 - 8	46304	46305	46306	—	—	7.874	2.755	1.397	1.102
2 - 8	46324	46325	46326	—	—	7.874	2.755	1.397	1.102

SPECIAL SIZES	Taper	Intermediate	Bottoming
UNEF 1/4 - 32	44044-32	44045-32	44046-32
HARLEY 1/4 - 24	44044-24	44045-24	44046-24
HARLEY 7/16 - 16	44074-16	44075-16	44076-16
CARB. 7/8 - 20	44144-20	44145-20	44146-20
CARB. 1 - 20	44164-20	44165-20	44166-20
CUMMINS 11/16 - 16	44114-16	44115-16	44116-16

LEFT HAND THREADS Metric	Intermediate
M6 - 1	45065LH
M8 - 1.25	45085LH
M10 - 1.5	45105LH
M12 - 1.75	45125LH

LEFT HAND THREADS UNC	Intermediate
1/4-20	43045LH
5/16-18	43055LH
3/8-16	43065LH
7/16-14	43075LH
1/2-13	43085LH

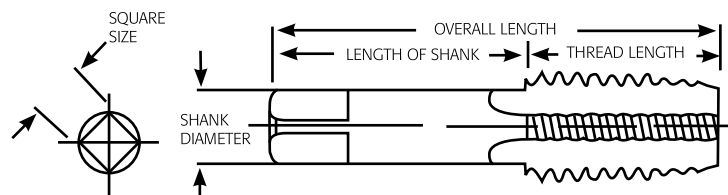

Recoil Tapped Hole and Fitted Size Data - Metric

METRIC (ISO) THREAD SIZE	DRILL SIZE	PITCH DIA							
		A MINOR DIA		B MAJ DIA	C CLASS 5H		C CLASS 6H		E INSERTS FITTED
		MAX	MIN		MAX	MIN	MAX	MIN	
M2 X 0.4	2.10	2.177	2.087	2.520	2.295	2.260	2.310	2.260	1.567
M2.2 X 0.45	2.30	2.397	2.297	2.785	2.532	2.492	2.547	2.492	1.713
M2.5 X 0.45	2.60	2.697	2.597	3.085	2.832	2.792	2.847	2.792	2.013
M3 X 0.5	3.10	3.220	3.108	3.650	3.367	3.325	3.384	3.325	2.459
M3.5 X 0.6	3.60	3.755	3.630	4.279	3.940	3.890	3.959	3.890	2.850
M4 X 0.7	4.10	4.292	4.152	4.909	4.509	4.455	4.529	4.455	3.242
M5 X 0.8	5.20	5.333	5.173	6.039	5.577	5.520	5.597	5.520	4.134
M6 X 1.0	6.20	6.406	6.216	7.299	6.719	6.650	6.742	6.650	4.917
M7 X 1.0	7.20	7.406	7.216	8.299	7.719	7.650	7.742	7.650	5.917
M8 X 1.0	8.20	8.406	8.216	9.299	8.719	8.650	8.742	8.650	6.917
M8 X 1.25	8.30	8.483	8.271	9.624	8.886	8.812	8.912	8.812	6.647
M9 X 1.25	9.30	9.483	9.271	10.624	9.886	9.812	9.912	9.812	7.647
M10 X 1.25	10.30	10.483	10.271	11.624	10.886	10.812	10.912	10.812	8.647
M10 X 1.5	10.30	10.561	10.325	11.949	11.061	10.974	11.089	10.974	8.376
M11 X 1.5	11.30	11.561	11.325	12.949	12.061	11.974	12.089	11.974	9.376
M12 X 1.25	12.30	12.483	12.271	13.624	12.898	12.812	12.926	12.812	10.647
M12 X 1.5	12.5	12.56	13.324	14.131	12.974	13.067	12.974	13.099	10.376
M12 X 1.75	12.40	12.644	12.379	14.273	13.236	13.137	13.271	13.137	10.106
M14 X 1.5	14.30	14.561	14.325	15.949	15.067	14.974	15.099	14.974	12.376
M14 X 2.0	14.40	14.733	14.433	16.598	15.406	15.299	15.444	15.299	11.835
M16 X 1.5	16.25	16.561	16.325	17.949	17.067	16.974	17.099	16.974	14.376
M16 X 2.0	16.50	16.733	16.433	18.598	17.406	17.299	17.444	17.299	13.835
M18 X 1.5	18.25	18.561	18.325	19.949	19.067	18.974	19.099	18.974	16.376
M18 X 2.0	18.50	18.733	18.433	20.598	19.406	19.299	19.444	19.299	15.835
M18 X 2.5	18.50	18.896	18.541	21.248	19.738	19.624	19.778	19.624	15.294
M20 X 1.5	20.25	20.561	20.325	21.949	21.067	20.974	21.099	20.974	18.376
M20 X 2.0	20.50	20.733	20.433	22.598	21.406	21.299	21.444	21.299	17.835
M20 X 2.5	20.50	20.896	20.541	23.248	21.738	21.624	21.778	21.624	17.294
M22 X 1.5	22.50	22.561	22.325	23.949	23.067	22.974	23.099	22.974	20.376
M22 X 2.0	22.50	22.733	22.433	24.598	23.406	23.299	23.444	23.299	19.835
M22 X 2.5	22.50	22.896	22.541	25.248	23.738	23.624	23.778	23.624	19.294
M24 X 2.0	24.25	24.733	24.433	26.598	25.414	25.299	25.454	25.299	21.835
M24 X 3.0	24.75	25.050	24.650	27.897	26.093	25.949	26.135	25.949	20.752
M27 X 3.0	27.50	28.050	27.650	30.897	29.093	28.949	29.135	28.949	23.752
M30 X 3.5	30.50	31.208	30.758	34.547	32.428	32.273	32.472	32.273	26.211
M33 X 3.5	33.50	34.208	33.758	37.547	35.428	35.273	35.472	35.273	29.211
M36 X 4.0	36.50	37.341	36.866	41.196	38.763	38.598	38.809	38.598	31.670
M39 X 4.0	39.50	40.341	39.866	44.196	41.763	41.598	41.809	41.598	34.670

Standard size drills are suggested even though in these sizes they vary slightly from minor diameter limits. Drill sizes are recommended only and test should be carried out to select the one suitable for the material involved. Countersinking: It is recommended that a 120° countersink is provided before tapping to prevent a feather edge at the start of the lead thread. When design prevents the use of a countersink, any feather edges or deformed material at the thread lead should be removed before tapping. This will facilitate insert installation and reduce the effects of removing the countersinking operation.

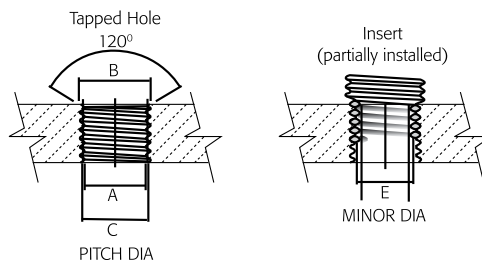

Recoil Tapped Hole and Fitted Size Data - Unified

UNC											
SIZE	T.P.I.	DRILL SIZE UNC		TAPPED HOLE				PITCH DIA			
		MM	INCH	A MI DIA MIN	B MAJ DIA	C CLASS 2B MAX	C MIN	C CLASS 3B MAX	C MIN	E INSERTS FITTED	
No.2	56	2.3	3/32	0.094	0.090	0.1092	0.0996	0.0976	0.989	0.0976	0.0667
No.3	48	2.7	No.36	0.108	0.104	0.1261	0.1147	0.1125	0.1139	0.1125	0.0764
No.4	40	3	No.31	0.122	0.118	0.1445	0.1307	0.1282	0.1298	0.1282	0.0849
No.5	40	3.4	No.29	0.135	0.131	0.1575	0.1437	0.1412	0.1429	0.1412	0.0979
No.6	32	3.7	No.25	0.150	0.145	0.1786	0.1611	0.1583	0.1601	0.1583	0.1042
No.8	32	4.4	11/64	0.175	0.171	0.2046	0.1872	0.1843	0.1862	0.1843	0.1302
No.10	24	5.0	13/64	0.205	0.199	0.2441	0.2204	0.2171	0.2193	0.2171	0.1449
No.12	24	5.8	15/64	0.230	0.225	0.2701	0.2465	0.2431	0.2454	0.2431	0.1709
1/4	20	6.7	17/64	0.270	0.261	0.3150	0.2863	0.2825	0.2851	0.2825	0.1959
5/16	18	8.3	21/64	0.334	0.325	0.3847	0.3529	0.3486	0.3515	0.3486	0.2524
3/8	16	9.9	25/64	0.398	0.389	0.4562	0.4203	0.4156	0.4189	0.4156	0.3073
7/16	14	11.5	29/64	0.463	0.453	0.5303	0.4890	0.4839	0.4875	0.4839	0.3602
1/2	13	13.0	17/32	0.527	0.517	0.5999	0.5554	0.5499	0.5537	0.5499	0.4167
9/16	12	14.5	19/32	0.591	0.581	0.6708	0.6225	0.6167	0.6208	0.6167	0.4723
5/8	11	16.5	21/32	0.656	0.645	0.7431	0.6903	0.6841	0.6885	0.6841	0.5266
3/4	10	19.75	25/32	0.783	0.772	0.8799	0.8216	0.8149	0.8196	0.8149	0.6417
7/8	9	23.0	29/32	0.912	0.899	1.0193	0.9543	0.9471	0.9522	0.9471	0.7547
1	8	26.0	11/32	1.042	1.027	1.1624	1.0890	1.0812	1.0868	1.0812	0.8647
1 1/8	7	29.5	15/32	1.170	1.156	1.3106	1.2262	1.2178	1.2239	1.2178	0.9704
1 1/4	7	33.0	19/32	1.295	1.281	1.4356	1.3514	1.3428	1.3490	1.3428	1.0954
1 3/8	6	36.0	113/32	1.431	1.411	1.5914	1.4926	1.4832	1.4900	1.4832	1.1946
1 1/2	6	39.0	117/32	1.556	1.536	1.7164	1.6177	1.6082	1.6151	1.6082	1.3196

UNF											
SIZE	T.P.I.	DRILL SIZE UNC		TAPPED HOLE				PITCH DIA			
		MM	INCH	A MI DIA MIN	B MAJ DIA	C CLASS 2B MAX	C MIN	C CLASS 3B MAX	C MIN	E INSERTS FITTED	
No.3	56	2.65	-	0.106	0.103	0.1222	0.1126	0.1106	0.1119	0.1106	0.0797
No.4	48	3.0	No.31	0.120	0.117	0.1391	0.1278	0.1255	0.1270	0.1255	0.0894
No.5	44	3.3	-	0.134	0.130	0.1545	0.1422	0.1398	0.1414	0.1398	0.1004
No.6	40	3.7	No.26	0.148	0.144	0.1705	0.1568	0.1542	0.1559	0.1542	0.1109
No.8	36	4.4	11/64	0.174	0.170	0.2001	0.1848	0.1820	0.1839	0.1820	0.1339
No.10	32	5.1	13/64	0.201	0.197	0.2306	0.2133	0.2103	0.2123	0.2103	0.1562
1/4	28	6.6	17/64	0.264	0.258	0.2964	0.2765	0.2732	0.2754	0.2732	0.2113
5/16	24	8.2	21/64	0.328	0.322	0.3666	0.3433	0.3395	0.3421	0.3395	0.2674
3/8	24	9.8	25/64	0.390	0.384	0.4291	0.4059	0.4020	0.4047	0.4020	0.3299
7/16	20	11.5	29/64	0.456	0.449	0.5025	0.4744	0.4700	0.4731	0.4700	0.3834
1/2	20	13.0	33/64	0.518	0.511	0.5650	0.5371	0.5325	0.5357	0.5325	0.4459
9/16	18	14.5	37/64	0.582	0.575	0.6347	0.6035	0.5986	0.6020	0.5986	0.5024
5/8	18	16.25	41/64	0.644	0.637	0.6972	0.6661	0.6611	0.6646	0.6611	0.5649
3/4	16	19.5	49/64	0.771	0.764	0.8312	0.7961	0.7906	0.7945	0.7906	0.6823
7/8	14	22.5	57/64	0.899	0.891	0.9678	0.9274	0.9214	0.9257	0.9214	0.7977
1	12	26.0	11/54	1.028	1.018	1.1083	1.0608	1.0542	1.0589	1.0542	0.9098
1 1/8	12	29.5	15/32	1.153	1.143	1.2333	1.1860	1.1792	1.1841	1.1792	1.0348
1 1/4	12	32.5	19/32	1.278	1.268	1.3583	1.3112	1.3042	1.3092	1.3042	1.1598
1 3/8	12	36.0	113/32	1.403	1.393	1.4833	1.4364	1.4292	1.4343	1.4292	1.2848
1 1/2	12	39.0	117/32	1.528	1.518	1.6083	1.5615	1.5542	1.5595	1.5542	1.4098

Standard size drills are suggested even though in these sizes they vary slightly from minor diameter limits. Drill sizes are recommended only and test should be carried out to select the one suitable for the material involved. Countersinking: It is recommended that a 120° countersink is provided before tapping to prevent a feather edge at the start of the lead thread. When design prevents the use of a countersink, any feather edges or deformed material at the thread lead should be removed before tapping. This will facilitate insert installation and reduce the effects of removing the countersinking operation.

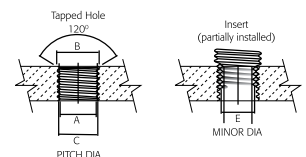

Recoil Tapped Hole and Fitted Size Data - BA

Thread Nominal Length	Recoil Spec Nominal Length Part #	Free Run Free Min-Max	Dia of Coils	Drill Size	A		B		C		E		BASIC LENGTH OF INSERT			
					Minor Dia min	Minor Dia max	Major Dia min	Class 2B min	Class 3B min	insets fitted	NOMINAL DIAMETER OF SCREW "D"	Q	R	S	T	
0	1 00502	4.15	4.15	-	0.2410	0.2460	0.2805	0.2598	0.2645	-	0.1890	0.236	0.197	0.413	0.374	
	1.5 00503	7.00	7.00	-	-	-	-	-	-	-	-	0.354	0.315	0.531	0.492	
	2 00504	7.40 - 7.50	9.85	6.20	0.2410	0.2460	0.2805	0.2598	0.2645	-	0.1890	0.472	0.433	0.649	0.610	
1	2.5 00505	12.80	12.80	-	-	-	-	-	-	-	-	0.591	0.552	0.768	0.729	
	3 00506	4.25	4.25	-	-	-	-	-	-	-	-	0.709	0.670	0.886	0.847	
	1.5 00523	7.05	7.05	-	-	-	-	-	-	-	-	0.185	0.153	0.329	0.297	
2	2 00524	5.70 - 5.85	9.85	4.90	0.1910	0.1960	0.2208	0.2042	0.2079	-	0.1468	0.370	0.338	0.514	0.482	
	2.5 00525	12.75	12.75	-	-	-	-	-	-	-	-	0.463	0.431	0.607	0.575	
	3 00526	15.55	15.55	-	-	-	-	-	-	-	-	0.555	0.523	0.699	0.667	
3	1 00542	3.85	3.85	-	-	-	-	-	-	-	-	0.142	0.116	0.259	0.233	
	1.5 00543	6.45	6.45	-	-	-	-	-	-	-	-	0.213	0.187	0.330	0.304	
	2 00544	4.40 - 4.55	9.05	3.80	0.1470	0.1520	0.1711	0.1574	0.1605	-	0.1106	0.283	0.257	0.400	0.374	
4	2.5 00545	11.65	11.65	-	-	-	-	-	-	-	-	0.354	0.328	0.471	0.445	
	3 00546	14.35	14.35	-	-	-	-	-	-	-	-	0.425	0.399	0.542	0.516	
	1 00562	3.45	3.45	-	-	-	-	-	-	-	-	0.110	0.089	0.204	0.183	
5	1.5 00563	6.00	6.00	-	-	-	-	-	-	-	-	0.165	0.144	0.259	0.238	
	2 00564	3.55 - 3.60	8.50	2.90	0.1130	0.1160	0.1339	0.1226	0.1252	-	0.0850	0.220	0.199	0.314	0.293	
	2.5 00565	13.50	13.50	-	-	-	-	-	-	-	-	0.276	0.255	0.370	0.349	
6	3 00566	13.50	13.50	-	-	-	-	-	-	-	-	0.331	0.310	0.425	0.404	

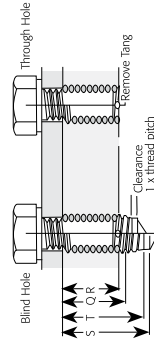

Drill Depth: The minimum drilling depth "S" allows for one pitch chip clearance between the tip of the tap and the bottom of the drilled hole. "S" minimum allows for tap clearance; the maximum amount of insert set-down and the countersink. Where a spiral pointed tap is used, the drill depths shown should be increased to allow for chip clearance. Fitted Insert: R = Maximum length of engaged portion of screw when tang is removed. Q = Minimum full tapped thread length. T = Minimum tapping depth - including 3 1/2 threads of plug tap. S = Minimum drill depth - excluding point.

Recoil Tapped Hole and Fitted Size Data - BSF

Thread Nominal Length	Recoil Spec Nominal Length Part #	Free Run Free Min-Max	Dia of Coils	Drill Size inch mm	A Minor Dia		B Major Dia	C Class 2B		C Class 3B		E inserts fitted	BASIC LENGTH OF INSERT					
					min	max		min	max	min	max		Q	R	S	T		
BSF	1	00032	4.40							0.187		0.156	0.327	0.296				
	1.5	00033	7.25							0.187		0.281	0.250	0.421	0.390			
	2	00034	5.80 - 6.00	5.00	13/64	0.192	0.198	0.2247	.2075*	.2098*	not recommended	0.1475	0.375	0.344	0.515	0.484		
	2.5	00035	13.05									0.468	0.437	0.608	0.577			
	3	00036	15.95									0.562	0.531	0.702	0.671			
	1	00042	4.85									0.250	0.212	0.423	0.385			
1.5	00043	7.95									0.375	0.337	0.548	0.510				
2	00044	7.65 - 7.90	11.15	6.60	17/64	0.257	0.264	0.2957	.2774*	not recommended	0.2008	0.500	0.462	0.673	0.635			
2.5	00045	14.25									0.625	0.587	0.798	0.760				
3	00046	17.45									0.750	0.712	0.923	0.885				
1	00052	5.15									0.312	0.267	0.516	0.471				
1.5	00053	8.55									0.469	0.424	0.673	0.628				
2	00054	9.65 - 9.90	11.85	8.20	21/64	0.323	0.33	0.3662	.3416*	not recommended	0.2543	0.625	0.580	0.829	0.784			
2.5	00055	15.15									0.781	0.736	0.985	0.940				
3	00056	18.55									0.937	0.982	1.141	1.096				
1	00062	5.75									0.375	0.325	0.600	0.550				
1.5	00063	9.45									0.562	0.512	0.787	0.737				
2	00064	11.20 - 11.50	13.05	9.80	25/64	0.385	0.392	0.434	.4104*	not recommended	0.311	0.750	0.700	0.975	0.925			
2.5	00065	16.75									0.937	0.887	1.162	1.112				
3	00066	20.35									1.125	1.075	1.350	1.300				
1	00072	6.15									0.437	0.381	0.687	0.631				
1.5	00073	9.95									0.656	0.600	0.906	0.850				
2	00074	13.00 - 13.35	13.75	11.50	29/64	0.45	0.458	0.503	0.473	0.4767	0.3663	0.875	0.819	1.125	1.069			
2.5	00075	17.65									1.093	1.037	1.343	1.287				
3	00076	21.45									1.312	1.256	1.562	1.506				
1	00082	6.25									0.500	0.737	0.781	0.719				
1.5	00083	10.15									0.750	0.688	1.031	0.969				
2	00084	14.85 - 15.25	14.05	13.00	33/64	0.513	0.522	0.5736	0.54	0.544	0.42	1.000	0.938	1.281	1.219			
2.5	00085	17.95									1.250	1.180	1.531	1.469				
3	00086	21.75									1.500	1.438	1.781	1.719				
1	00092	7.25									0.562	0.500	0.843	0.781				
1.5	00093	11.65									0.844	0.782	1.125	1.063				
2	00094	16.50 - 16.85	15.95	14.50	37/64	0.577	0.586	0.6362	0.6025	0.6067	0.4825	1.125	1.062	1.406	1.344			
2.5	00095	20.35									1.406	1.344	1.687	1.625				
3	00096	24.75									1.687	1.625	1.968	1.906				
1	00102	7.05									0.625	0.554	0.946	0.875				
1.5	00103	11.25									0.937	0.866	1.258	1.187				
2	00104	18.40 - 18.75	15.45	16.20	41/64	0.64	0.649	0.7091	0.6708	0.6752	1.250	1.179	1.571	1.500				
2.5	00105	19.75									1.562	1.491	1.883	1.812				
3	00106	23.95									1.875	1.804	2.196	2.125				

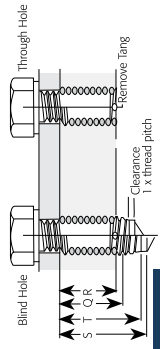

Drill Depth: The minimum drilling depth "S" allows for one pitch chip clearance between the tip of the tap and the bottom of the drilled hole. "S" minimum allows for tap clearance, the maximum amount of insert set-down and the countersink. Where a spiral pointed tap is used, the drill depths shown should be increased to allow for chip clearance. Fitted Insert: R = Maximum length of engaged portion of screw when tang is removed. Q = Minimum full tapped thread length. T = Minimum tapping depth - including 3 1/2 threads of plug tap. S = Minimum drill depth - excluding point.

Recoil Tapped Hole and Fitted Size Data - BSF (con't)

Recoil Spec	Thread Nominal Length Part	Dia of Coils	Free Run Free Min-Max	Drill Size	A		B		C		E		BASIC LENGTH OF INSERT									
					Minor Dia	Major Dia	Class 2B	Class 3B	inserts fitted	NOMINAL DIAMETER OF SCREW "D"	Q	R	S	T								
	Dia #			mm	inch	min	max	min	max	min	max											
	1	00122		7.25									0.750	0.667	1.125	1.042						
	1.5	00123		11.65									1.125	1.042	1.500	1.417						
3/4-12	2	00124	22.30 - 22.70	15.95	49/64	0.765	0.775	0.8033	0.8082	0.8033*	0.8062*	0.6432	1.500	1.417	1.875	1.792						
	2.5	00125		20.35									1.875	1.792	2.250	2.167						
	3	00126		24.75									2.250	2.167	2.625	2.542						
	1	00142		7.85									0.875	0.784	1.284	1.193						
	1.5	00143		12.55									1.312	1.221	1.721	1.630						
7/8-11	2	00144	25.50 - 25.90	17.15	57/64	0.89	0.9	0.9332	0.9384	0.9332*	0.9364*	0.7586	1.750	1.659	2.159	2.068						
	2.5	00145		21.85									2.187	2.096	2.596	2.505						
	3	00146		26.55									2.625	2.534	3.034	2.943						
	1	00162		8.25									1.000	0.900	1.450	1.350						
	1.5	00163		13.05									1.500	1.400	1.950	1.850						
1-10	2	00164	29.35 - 29.80	17.95	26.00	1 1/32	1.031	1.044	1.0697	1.0641*	1.0675*	0.872	2.000	1.900	2.450	2.350						
	2.5	00165		22.75									2.500	2.400	2.950	2.850						
	3	00166		27.65									3.000	2.900	3.450	3.350						
	1	00202		9.45									1.250	1.139	1.750	1.639						
	1.5	00203		14.85									1.875	1.764	2.375	2.264						
1-1/4-9	2	00204	35.90 - 36.35	20.35	32.50	1 9/32	1.281	1.295	1.3274	1.3212*	1.3250*	1.1078	2.500	2.389	3.000	2.889						
	2.5	00205		25.75									3.125	3.014	3.625	3.514						
	3	00206		31.25									3.750	3.639	4.250	4.139						

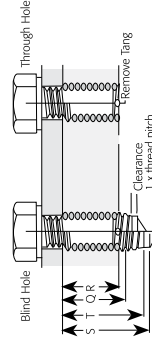

Drill Depth: The minimum drilling depth "S" allows for one pitch chip clearance between the tip of the tap and the bottom of the drilled hole. "S" minimum allows for tap clearance, the maximum amount of insert set-down and the countersink. Where a spiral pointed tap is used, the drill depths shown should be increased to allow for chip clearance. Fitted Insert: R = Maximum length of engaged portion of screw when tang is removed. Q = Minimum full tapped thread length. T = Minimum tapping depth - including 3 1/2 threads of plug tap. S = Minimum drill depth - excluding point.

Recoil Tapped Hole and Fitted Size Data - BSP

Thread Nominal	Recoil Spec Nominal Length	Part Dia #	Free Run Free Min-Max	Dia of Coils	Drill Size inch	A		B		C		E						
						Minor Dia		Major Dia		Class 2B		Class 3B		inserts				
						min	max	min	max	min	max	min	max	Q	R	S	T	
BSP																		
	1	01022		3.10								0.125	0.089	0.287	0.251			
	1.5	01023		4.75								0.187	0.151	0.349	0.313			
1/8-28	2	01024	11.0 - 11.35	6.35	9.900	3/8	0.3900	0.4000	0.4258	0.4058	0.409	not recommended		0.3372	0.250	0.214	0.412	0.376
	2.5	01025		7.95								0.312	0.276	0.474	0.438			
	3	01026		9.60								0.375	0.339	0.537	0.501			
	1	01042		3.05								0.250	0.197	0.488	0.435			
	1.5	01043		5.35								0.375	0.322	0.613	0.560			
1/4-19	2	01044	15.0 - 15.35	7.35	13.500	33/64	0.5300	0.5400	0.5803	0.5517	0.5556	not recommended		0.4506	0.500	0.447	0.738	0.685
	2.5	01045		9.85								0.625	0.572	0.863	0.810			
	3	01046		12.15								0.750	0.697	0.988	0.935			
	1	01062		5.85								0.375	0.322	0.613	0.560			
	1.5	01063		9.35								0.562	0.509	0.800	0.747			
3/8-19	2	01064	18.6 - 18.85	12.95	17.000	21/32	0.6700	0.6800	0.7184	0.6897	1.6937	not recommended		0.5886	0.750	0.697	0.988	0.935
	2.5	01065		15.75								0.937	0.884	1.175	1.122			
	3	01066		19.25								1.125	1.072	1.363	1.310			
	1	01082		5.25								0.500	0.429	0.820	0.749			
	1.5	01083		8.60								0.750	0.679	1.070	0.999			
1/2-14	2	01084	23.6 - 24.0	11.95	21.500	13/16	0.8400	0.8500	0.9092	0.8708	0.8754	not recommended		0.7336	1.000	0.929	1.320	1.249
	2.5	01085		15.25								1.250	1.179	1.570	1.499			
	3	01086		18.60								1.500	1.429	1.820	1.749			
	1	01102		6.95								0.625	0.554	0.945	0.874			
	1.5	01103		11.25								0.937	0.866	1.257	1.186			
5/8-14	2	01104	25.4 - 26	15.45	23.500	59/64	0.9150	0.9270	0.9863	0.9478	0.9524	0.9478	0.9506	0.8106	1.250	1.179	1.570	1.499
	2.5	01105		20.35								1.562	1.491	1.882	1.811			
	3	01106		23.95								1.875	1.804	2.195	2.124			
	1	01122		8.65								0.750	0.679	1.070	0.999			
	1.5	01123		13.75								1.125	1.054	1.445	1.374			
3/4-14	2	01124	29.3 - 29.8	18.85	27.000	1/64	1.0530	1.0660	1.1255	1.0868	1.0918	1.0868	1.0898	0.9496	1.500	1.429	1.820	1.749
	2.5	01125		24.05								1.875	1.804	2.195	2.124			
	3	01126		29.10								2.250	2.179	2.570	2.499			
	1	01162		9.15								1.000	0.909	1.410	1.319			
	1.5	01163		14.55								1.500	1.409	1.910	1.819			
1"-11	2	01164	36.85 - 37.30	25.25	33.500	1/32	1.3200	1.3350	1.4158	1.3673	1.3727	1.3673	1.3705	1.1926	2.000	1.909	2.410	2.319
	2.5	01165		30.55								2.500	2.409	2.910	2.819			
	3	01166		36.15								3.000	2.909	3.410	3.319			
	1	01202		11.50								1.250	1.159	1.660	1.569			
	1.5	01203		18.00								1.875	1.784	2.285	2.194			
1 1/4-11	2	01204	46.60 - 47.10	24.60	43.500	1/32	1.6650	1.6800	1.7571	1.7083	1.7141	1.7083	1.7118	1.5336	2.500	2.409	2.910	2.819
	2.5	01205		30.15								3.125	3.034	3.535	3.440			
	3	01206		36.15								3.750	3.659	4.160	4.069			
	1	01242		18.15								1.500	1.409	1.910	1.819			
	1.5	01243		27.95								2.250	2.159	2.660	2.569			
1 1/2-11	2	01244	52.70 - 53.25	27.85	51.500	1/32	1.9060	1.9210	1.9893	1.9403	1.9464	1.9403	1.944	1.7656	3.000	2.909	3.410	3.319
	2.5	01245		33.35								3.750	3.659	4.160	4.069			
	3	01246		39.35								4.500	4.409	4.910	4.819			

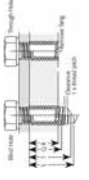

Drill Depth: The minimum drilling depth "S" allows for one pitch chip clearance between the tip of the tap and the bottom of the drilled hole. "S" minimum allows for tap clearance, the maximum amount of insert set-down and the countersink. Where a spiral pointed tap is used, the drill depths shown should be increased to allow for chip clearance. Fitted Insert: R = Maximum length of engaged portion of screw when tang is removed. Q = Minimum full threaded thread length. T = Minimum tapping depth - including 3 1/2 threads of plug tap. S = Minimum drill depth - excluding point.

Recoil Tapped Hole and Fitted Size Data - BSW

Thread Nominal Length	Recoil Spec Nominal Length Part #	Free Run Free Min-Max	Dia of Coils	Drill Size	A		B	C		E	BASIC LENGTH OF INSERT						
					Minor Dia min	Minor Dia max		Major Dia min	Class 2B min		Class 3B min	insets fitted	NOMINAL DIAMETER OF SCREW "D"	Q	R	S	T
3/16-24	1	02032	3.00								0.187	0.146	0.375	0.332			
	1.5	02033	4.90								0.281	0.24	0.468	0.426			
	2	02034	6.00 - 6.30	5	13/64	0.196	0.202	0.2365	0.2141*	0.2166*	not recommended	0.1341	0.375	0.334	0.562	0.52	
1/4-20	2.5	02035	9.30								0.468	0.427	0.656	0.612			
	3	02036	11.40								0.562	0.521	0.750	0.708			
	1	02042	3.375								0.250	0.200	0.475	0.425			
5/16-18	1.5	02043	5.750								0.375	0.325	0.600	0.550			
	2	02044	8.10 - 8.35	6.7	17/64	0.261	0.267	0.3087	0.2820*	0.2849*	not recommended	0.1860	0.500	0.450	0.725	0.675	
	2.5	02045	10.375								0.625	0.575	0.850	0.800			
3/8-16	3	02046	12.750								0.750	0.700	0.975	0.925			
	1	02052	4.00								0.312	0.257	0.562	0.507			
	1.5	02053	6.60								0.469	0.413	0.719	0.663			
7/16-14	2	02054	9.85 - 10.05	8.3	21/64	0.328	0.334	0.3777	0.3480*	0.3512*	not recommended	0.2413	0.625	0.569	0.875	0.819	
	2.5	02055	11.85								0.781	0.726	1.031	0.976			
	3	02056	14.60								0.937	0.882	1.187	1.132			
1/2-12	1	02062	4.375								0.375	0.312	0.656	0.594			
	1.5	02063	7.250								0.562	0.500	0.844	0.781			
	2	02064	11.50 - 11.85	10.000	9.9	25/64	0.398	0.4483	0.4150	0.4185	0.4150*	0.4170*	0.750	0.687	1.031	0.969	
9/16-12	2.5	02065	12.875								0.937	0.875	1.219	1.156			
	3	02066	15.750								1.125	1.062	1.406	1.344			
	1	02072	4.500								0.437	0.366	0.759	0.687			
1/2-12	1.5	02073	7.375								0.656	0.585	0.978	0.906			
	2	02074	13.35 - 14.00	10.250	11.5	29/64	0.453	0.5212	0.4833	0.4871	0.4833*	0.4855*	0.3461	0.875	0.804	1.196	1.125
	2.5	02075	13.125								1.093	1.022	1.415	1.343			
1/2-12	3	02076	16.125								1.312	1.241	1.634	1.562			
	1	02082	4.25								0.500	0.417	0.888	0.792			
	1.5	02083	7.05								0.750	0.667	1.125	1.042			
9/16-12	2	02084	15.15 - 15.60	9.85	13	17/32	0.515	0.525	0.5333	0.5575	0.5533*	0.5557*	0.3932	1.000	0.917	1.375	1.292
	2.5	02085	12.45								1.250	1.167	1.625	1.542			
	3	02086	15.45								1.500	1.417	1.875	1.792			
1/2-12	1	02092	5.125								0.562	0.479	0.937	0.854			
	1.5	02093	8.250								0.844	0.76	1.219	1.135			
	2	02094	16.99 - 17.70	11.500	15	19/32	0.578	0.588	0.6158	0.6201	0.6158*	0.6184*	0.4557	1.125	1.042	1.500	1.417
1/2-12	2.5	02095	14.750								1.406	1.323	1.781	1.698			
	3	02096	17.125								1.687	1.604	2.062	1.979			

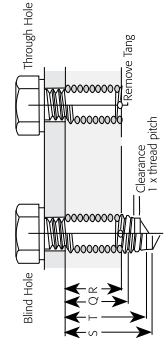

Drill Depth: The minimum drilling depth "S" allows for one pitch chip clearance between the tip of the tap and the bottom of the drilled hole. "S" minimum allows for tap clearance, the maximum amount of insert set-down and the countersink. Where a spiral pointed tap is used, the drill depths shown should be increased to allow for chip clearance. Fitted Insert: R = Maximum length of engaged portion of screw when tang is removed. Q = Minimum full tapped thread length. T = Minimum tapping depth - including 3 1/2 threads of plug tap. S = Minimum drill depth - excluding point.

Recoil Tapped Hole and Fitted Size Data - 8UN

Recoil Spec	Thread Nominal Length	Nominal Dia #	Free Run Free	Dia of Coils	Drill Size	A		B	C		E	BASIC LENGTH OF INSERT																							
						Minor Dia min	Minor Dia max		Major Dia min	Class 2B min		Class 3B min	Class 3B max	insets	NOMINAL DIAMETER OF SCREW "D"	Q	R	S	T																
8UN																																			
1	06182	6.95	16182	6.95	16182							28.575	25.400	42.863	39.688																				
1.5	06183	11.25	16183	11.25	16183							42.863	39.688	57.150	53.975																				
2	06184	32.00 - 32.90	16184	1.130	1.1550	1.1688	1.1757	1.261				1.0438	1.0528	71.438	68.263	85.725	82.550																		
2.5	06185	19.75	16185																																
3	06186	23.95	16186																																
1	06202	7.85	16202																																
1.5	06203	12.75	16203																																
2	06204	35.00 - 36.00	16204	1.255	1.2800	1.2938	1.3008	1.386																											
2.5	06205	22.15	16205																																
3	06206	26.85	16206																																
1	06222	8.85	16222																																
1.5	06223	14.15	16223																																
2	06224	38.50 - 39.50	16224	1.380	1.4050	1.4188	1.4259	1.511																											
2.5	06225	24.65	16225																																
3	06226	29.95	16226																																
1	06242	9.85	16242																																
1.5	06243	15.45	16243																																
2	06244	41.60 - 42.60	16244	1.505	1.5300	1.5438	1.551	1.636																											
2.5	06245	26.95	16245																																
3	06246	32.65	16246																																
1	06262	10.95	16262																																
1.5	06263	17.15	16263																																
2	06264	47.00 - 48.00	16264	1.630	1.6550	1.6688	1.6762	1.761																											
2.5	06265	29.55	16265																																
3	06266	35.75	16266																																
1	06282	11.85	16282																																
1.5	06283	18.55	16283																																
2	06284	50.30 - 51.40	16284	1.755	1.7800	1.7938	1.8013	1.886																											
2.5	06285	31.85	16285																																
3	06286	38.55	16286																																
1	06302	12.85	16302																																
1.5	06303	19.95	16303																																
2	06304	53.00 - 54.00	16304	1.880	1.9050	1.9188	1.9264	2.011																											
2.5	06305	34.25	16305																																
3	06306	41.45	16306																																
1	06322	13.75	16322																																
1.5	06323	21.45	16323																																
2	06324	56.5 - 57.40	16324	2.030	2.0438	2.0515	2.136	1.9188																											
2.5	06325	36.65	16325																																
3	06326	44.25	16326																																

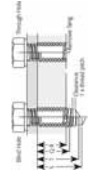

Drill Depth: The minimum drilling depth "S" allows for one pitch chip clearance between the tip of the tap and the bottom of the drilled hole. "S" minimum allows for tap clearance, the maximum amount of insert set-down and the countersink. Where a spiral pointed tap is used, the drill depths shown should be increased to allow for chip clearance. Fitted Insert: R = Maximum length of engaged portion of screw when tang is removed. Q = Minimum full tapped thread length. T = Minimum tapping depth - including 3/2 threads of plug tap. S = Minimum drill depth - excluding point.

Design and Installation Data - NPT

Drilled Hole

Nominal Thread Size	S Diameter		Min Depth	
	Reaming (Anpt)	No Reaming (NPT)	Plug Tap S_p	Bottom Tap S_b
	1	2	3	4
1/8-27	U (.3680)	W (.3860)	0.592	0.466
1/4-18	31/64 (.4844)	33/64 (.5156)	0.833	0.606
3/8-18	5/8 (.6250)	21/32 (.6562)	0.840	0.619
1/2-14	25/32 (.7812)	1 1/64 (1.0156)	1.074	0.794
3/4-14	63/64 (.9844)	1 1/64 (1.0156)	1.074	0.794
1-11 1/2	1 1/4 (1.2500)	1 9/32 (1.2812)	1.302	0.972

Reamed Hole

M Diameter	Min	Max	Min Depth*	
			Plug Top R_p	Bottom Top R_b
	5	6	7	8
	0.3963	0.4047	0.519	0.447
	0.5265	0.5386	0.676	0.578
	0.6619	0.6740	0.684	0.590
	0.8247	0.8390	0.841	0.726
	1.0351	1.0494	0.846	0.745
	1.2058	1.3125	1.005	0.892

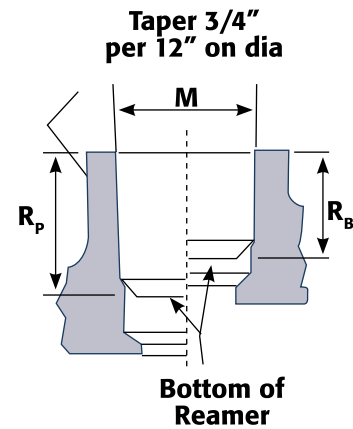
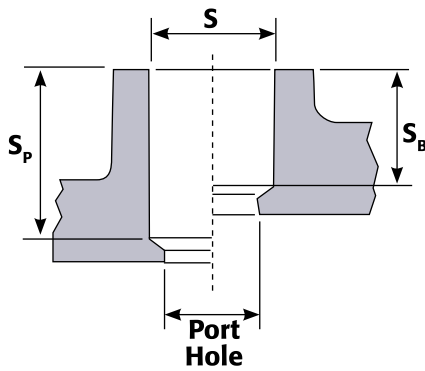

Tool Part Numbers

Nominal Thread Size	Plug	Tap+ Bottom	Plain Taper Plug	Gages		Inserting Tool	Extracting Tool
				L_1 Thread Plug	L_3 Thread Plug		
1/8-27	46025	46026	66023P	66023L1	66023L3	50313	50003
1/4-18	46045	46046	66043P	66043L1	66043L3	50438	50003
3/8-18	46065	46066	66063P	66063L1	66063L3	50500	50003
1/2-14	46085	46086	66083P	66083L1	66083L3	50688	50003
3/4-14	46125	46126	66126P	66123L1	66123L3	50875	50004
1-11 1/2	46165	46166	66166P	66123L1	66163L3	51125	50004

May also be used in aluminium, cast iron, mild steel, and brass for limited production. Production taps for these and other materials are available on special order.

Insert Identification

Nominal Thread Size	Part No.	Free No. Length	Free Outside Diameter	(Counted from Notch)Max
1/8-27	66023	0.273	5.15	0.511
1/4-18	66043	0.394	4.95	0.680
3/8-18	66063	0.407	5.35	0.828
1/2-14	66083	0.534	5.45	1.035
3/4-14	66123	0.553	5.8	1.262
1-11 1/2	66163	0.661	5.65	1.575

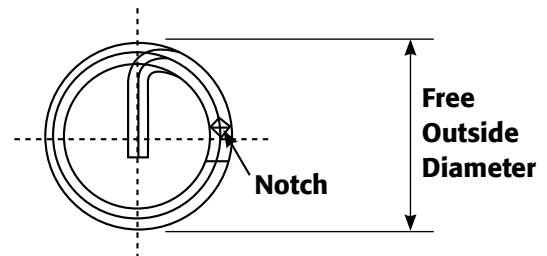

Design and Installation Data - NPT

Tapped Hole

Pitch Diameters			Major Dia Max	Min Depth	
E_{10}	E_{11}	E_{13}	Plug Tap (T_P)	Bottom Tap (T_8)	
10	11	12	13	14	15
0.41761	0.42770	0.41066	0.459	0.536	0.409
0.55967	0.57391	0.54925	0.621	0.749	0.568
0.69429	0.70929	0.68388	0.757	0.756	0.580
0.86579	0.88579	0.85240	0.947	0.962	0.740
1.07504	1.09623	1.06165	1.157	0.966	0.759
1.34531	1.37031	1.32901	1.445	1.172	0.929

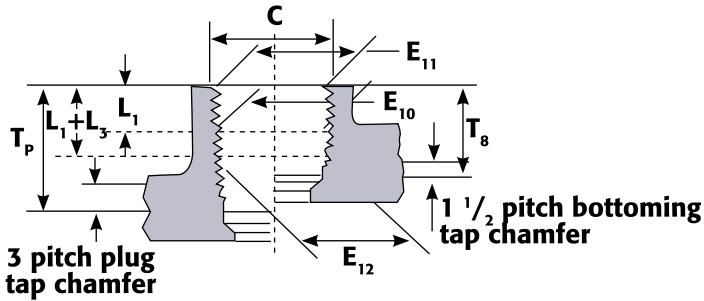

Assembled Insert Specifications

Basic Lengths				Basic Pitch Diameters			
L_1	L_2	$L_1 + L_3$	E_0	E_1	E_2	E_3	D
16	17	18	19	20	21	22	23
0.1615	0.26385	.27261	0.36351	0.37351	0.38000	0.35656	0.405
0.2278	0.40178	0.39447	0.47739	0.49163	0.5250	0.46697	0.540
0.240	0.40778	0.40667	0.61201	0.62701	0.63750	0.60160	0.675
0.320	0.53371	0.53429	0.75843	0.77843	0.79179	0.74504	0.840
0.399	0.68278	0.55329	0.96768	0.98887	1.00179	0.95429	1.050
0.400	0.68278	0.66087	1.21363	1.238631	1.25630	1.19733	1.315

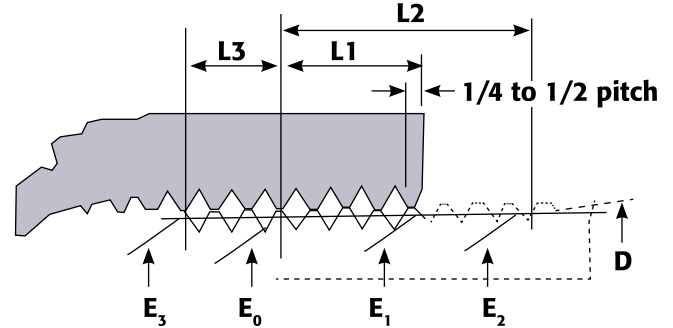

Notes:

Depths of reaming and tapping are reference dimensions only. Actual hole depths are governed by use of pipe thread gauges.

D = Outside diameter of pipe – major diameter of pipe thread at L_2 from end of pipe

E_0 = Basic pitch diameter of thread at end of pipe
 $= D - (0.05D + 1.1) P$

E_1 = Basic pitch diameter of thread at end of coupling
 $= E_0 + 0.0625L_1$

E_2 = Basic pitch diameter of thread at L_2 from end of pipe
 $= E_0 + 0.0625L_2$

E_3 = Basic pitch diameter of thread at L_3 from end of pipe
 $= E_0 - 0.1875P$

L_1 = Normal engagement by hand between external and internal threads

L_2 = Effective length of external thread
 $= P(0.8D + 6.8)$

L_3 = Normal wrench take-up

L_1 = Effective length of internal threads.
 + Nominal insert length.

L_3 = Minimum full thread in blind holes.
 Minimum boss thickness for through holes.

How to use inserts

Recoil Pipe Thread Inserts are simply installed following the steps below described in the process sheet.

DRILL using a standard drill (and ream for AMPT)

TAP with a Recoil Tap

GAUGE the hole to recommended tolerance when required

INSTALL the inserts with Recoil tool

BREAK OFF THE TANG*



Important Note:

Spiral Leakage could occur due to extremes of truncation and pitch diameter tolerances can create crest and root (major and minor diameter) clearances that might allow a void. The normal practice of using sealing compounds should be followed when producing Recoil Pipe Thread Insert assemblies.

Process Sheet - NPT

Operation	ANPT	NPT	Procedure
Drilling	Col. 1	Col. 2	Normal drilling methods should be followed. Drill sizes are recommended only and test should be carried out to select the one suitable for the material and process involved. Drill to depth given in col. 3 or 4
Taper reaming			Check hole with plain taper plug gauge (part number shown in Col. 27). Ream to depth shown in Col. 7 or 8 and diameter as shown in Col. 5 and 6
Tapping	Col. 25 or 26		Normal tapping methods should be followed. Recoil pipe thread taps are wrapped with a strand of copper wire to indicate approximate tapping depth. Actual depth and size must be controlled by gauging. Tap to given depth in Col. 14 or 15
Gauging	Col. 27		Plain taper plug: Used to check taper, roundness, and diameter at the crest of thread
	Col. 28		<p>L₁ thread plug: used to check diameter, lead, form, and taper of that portion of thread which will be engaged when the male thread part is screwed in by hand. This is the only gauge used when working to NPT. Tapped hole must be within MIN and MAX steps on L₁ gauge.</p> <p>L₃ thread plug: Used to check diameter, lead, form, and taper of thread at lower portion of hole – those threads that will be engaged by wrench pressure.</p> <p>ANPT GAUGING PROCEDURE ANPT gauging requires the use of L₁, L₃ and plain taper gauges. L₁ and L₃ gauges have notches denoting Maximum (MX), Basic (B), and Minimum (MN). The plain taper plug gauge has three additional notches which indicate truncation tolerances: Maximum Tolerance (MXt), Basic Tolerances (Bt), and Minimum Tolerance (MNt). The use of these three gauges establishes an acceptable threaded hole as Maximum, Basic or Minimum.</p> <p>First, gauge the hole with the L₁ gauge, noting the actual position of the steps in relation to the hole. If the Minimum step reaches the edge of the hole, the hole is classified Minimum. If L₁ stops at Basic or Maximum, the hole is classified either Basic or Maximum.</p> <p>Now gauge the hole with the L₃ gauge, checking that the proper step comes into the same relative position with the edge of the hole that the L₁ did. The L₃ gauge must not vary more than ½ turn from the position established by the L₁ gauge.</p> <p>Finally, check the hole with the plain taper gauge. The edge of the hole must come between the Minimum (MN) and Minimum Tolerance (MNt) steps if Minimum is what the L₁ gauge showed the hole to be. (If the L₁ gauge showed the hole to be Basic, the plain plug would have to be between B and Bt; if L₁ were Maximum, the plain plug would have to be between MX and MXt)</p> <p>Gauging of the assembled insert is not necessary if this procedure has been followed.</p>
Inserts	Page 4		The same Recoil inserts are used for both ANPT and NPT.
Installation	Col. 30		Wind the insert in with light pressure until ¼ to ½ below the surface, driving tang towards the bottom of the hole.

Design and Installation Data - NPT

Tang Removal	Remove tool and sit back on top of tang. Tap down sharply. Do not twist tang off. Or with long nosed pliers pull the tang out.												
Assembly	<p>We recommend that a suitable non hardening paste type sealing compound be used with ANPT and NPT pipe threads. Application factors such as machining accuracy, type of fluid gas flowing through the connection, pressures, temperature and pipe material will determine the type of sealant best suited for the individual application. The following typical compounds are suggested for the conditions listed:</p> <table data-bbox="459 533 1390 709"><tr><td data-bbox="459 533 699 596">Petroleum oils Water, Steam</td><td data-bbox="707 533 1390 596">Antiseize compound per MIL-A-907 (Led-Plate 250, product of Armit Laboratories)</td></tr><tr><td data-bbox="459 638 699 701">Oxygen system</td><td data-bbox="707 638 1390 701">Thread compound per MIL-T-5542 (Rectorseal-15, product of Rector Well Equipment Company)</td></tr></table>	Petroleum oils Water, Steam	Antiseize compound per MIL-A-907 (Led-Plate 250, product of Armit Laboratories)	Oxygen system	Thread compound per MIL-T-5542 (Rectorseal-15, product of Rector Well Equipment Company)								
Petroleum oils Water, Steam	Antiseize compound per MIL-A-907 (Led-Plate 250, product of Armit Laboratories)												
Oxygen system	Thread compound per MIL-T-5542 (Rectorseal-15, product of Rector Well Equipment Company)												
Torque	<p>After applying thread compound to male thread, assemble male thread into installed insert using the following tightening torques per MIL-T-542</p> <table data-bbox="459 848 919 1050"><tr><td data-bbox="459 848 699 877">3/4-14</td><td data-bbox="707 848 919 877">950 inch pounds</td></tr><tr><td data-bbox="459 884 699 913">1/8 – 27</td><td data-bbox="707 884 919 913">150 inch pounds</td></tr><tr><td data-bbox="459 919 699 949">1-11 1/2</td><td data-bbox="707 919 919 949">1800 inch pounds</td></tr><tr><td data-bbox="459 955 699 984">1/4 - 18</td><td data-bbox="707 955 919 984">250 inch pounds</td></tr><tr><td data-bbox="459 991 699 1020">3/8 – 18</td><td data-bbox="707 991 919 1020">450 inch pounds</td></tr><tr><td data-bbox="459 1026 699 1056">1/2 - 14</td><td data-bbox="707 1026 919 1056">600 inch pounds</td></tr></table>	3/4-14	950 inch pounds	1/8 – 27	150 inch pounds	1-11 1/2	1800 inch pounds	1/4 - 18	250 inch pounds	3/8 – 18	450 inch pounds	1/2 - 14	600 inch pounds
3/4-14	950 inch pounds												
1/8 – 27	150 inch pounds												
1-11 1/2	1800 inch pounds												
1/4 - 18	250 inch pounds												
3/8 – 18	450 inch pounds												
1/2 - 14	600 inch pounds												

Drill, Tapping and Installation Depths

NOMINAL THREAD SIZE	BOLT PROJECTION MINIMUM AND MAXIMUM									
	MIN DRILL DEPTH DIAMETER	INSERT LENGTH	INTERMEDIATE TAP	BOTTOMING TAP	1 DIA	NOMINAL LENGTH 1.5 DIA	2 DIA	1 DIA	NOMINAL LENGTH 1.5 DIA	2 DIA
1 1/8-8	1D	1.125	1.813	1.438						
	1.5D	1.688	2.376	2.001	0.96	1.24	1.52	1.06	1.63	2.19
	2D	2.250	2.938	2.563						
1 1/4-8	1D	1.250	1.938	1.563						
	1.5D	1.875	2.563	2.188	1.02	1.34	1.65	1.19	1.81	2.44
	2D	2.500	3.188	2.813						
1 3/8-8	1D	1.375	2.063	1.688						
	1.5D	2.062	2.750	2.375	1.09	1.43	1.77	1.31	2.00	2.69
	2D	2.750	3.438	3.063						
1 1/2-8	1D	1.500	2.188	1.813						
	1.5D	2.250	2.938	2.563	1.15	1.52	1.90	1.44	2.19	2.94
	2D	3.000	3.688	3.313						
1 5/8-8	1D	1.625	2.313	1.938						
	1.5D	2.438	3.126	2.751	1.27	1.68	2.09	1.56	2.38	3.19
	2D	3.250	3.938	3.563						
1 3/4-8	1D	1.750	2.438	2.063						
	1.5D	2.625	3.313	2.938	1.52	1.96	2.40	1.69	2.65	3.44
	2D	3.500	4.188	3.813						
1 7/8-8	1D	1.875	2.563	2.188						
	1.5D	2.812	3.500	3.125	1.59	2.05	2.52	1.81	2.75	3.69
	2D	3.750	4.438	4.063						
2-8	1D	2.000	2.688	2.313						
	1.5D	3.000	3.688	3.313	1.65	2.15	2.65	1.94	2.94	3.94
	2D	4.000	4.688	4.313						

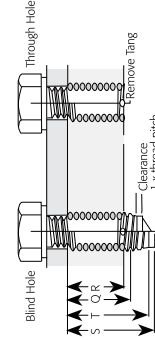

Drill Depth: The minimum drilling depth "S" allows for one pitch chip clearance between the tip of the tap and the bottom of the drilled hole. "S" minimum allows for tap clearance, the maximum amount of insert set-down and the countsink. Where a spiral pointed tap is used, the drill depths shown should be increased to allow for chip clearance. Fitted Insert: R = Maximum length of engaged portion of screw when tang is removed. Q = Minimum full tapped thread length. T = Minimum tapping depth - including 3 1/2 threads of plug tap. S = Minimum drill depth - excluding point.

Tap Terminology

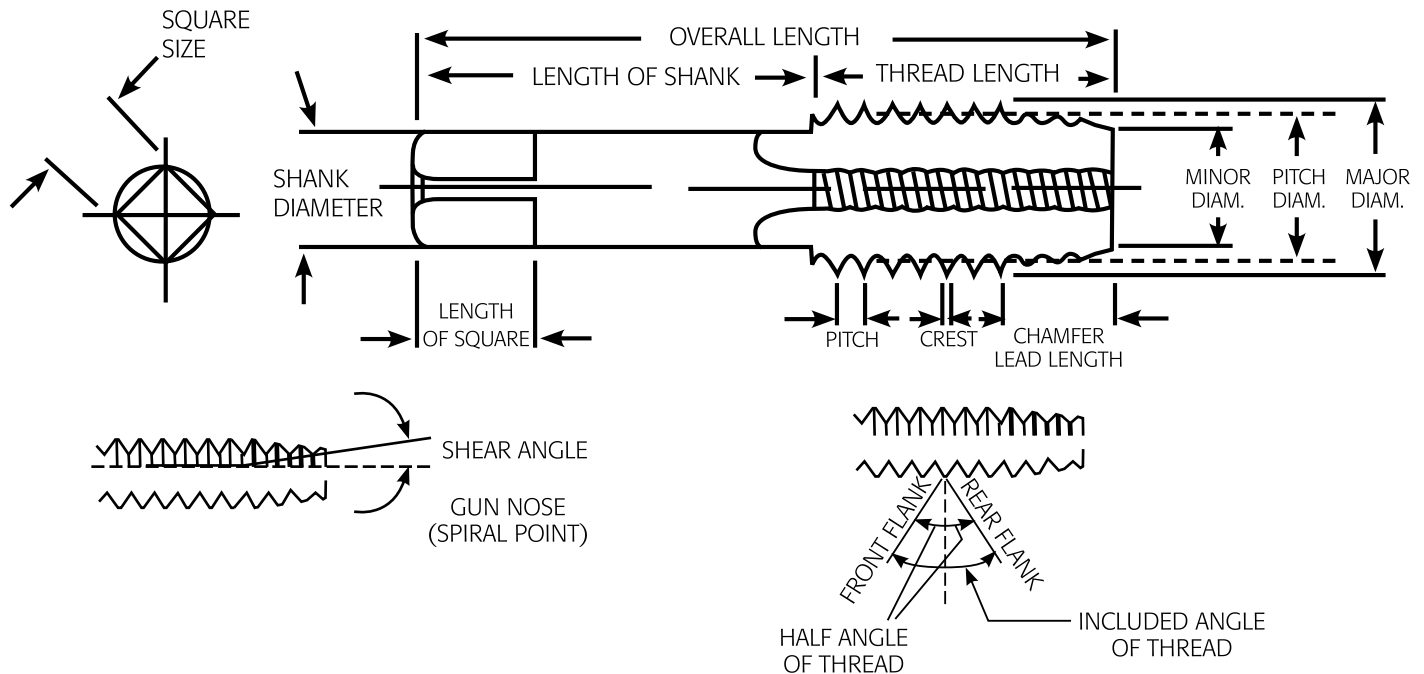

Actual Size

An actual size is a measured size

Allowance

An allowance is the prescribed difference between the design (maximum material) size and the basic size. It is numerically equal to the absolute value of the ISO term fundamental deviation.

Angle of Thread

The included angle between the flanks of a thread measured in an axial plane

Back Taper

A slight taper on the threaded portion of the tap making the pitch diameter near the shank smaller than that at the centre

Basic

The theoretical or nominal standards size from which all variations are made

Chamfer

The tapered and relieved cutting teeth at the front end of the threaded section. Common types of chamfer are taper, intermediate or bottoming

Crest

The top joining the two sides or flanks of a thread

Crest Clearance

The space between the crest of a thread and the root of its component

Cutting Face

The leading face of the land

Flank

The surface of the thread, sometimes referred to as the side of the thread which connects the crest with the root

Flute

The longitudinal channels formed on a tap to create cutting edges on the thread profile

Hand of Threads

- A Right Hand Thread is advanced by turning it to the right or clockwise
- A Left Hand Thread is advanced by turning it to the left or anticlockwise
- All left handed threads are designated LH

Heel

The following side of the land

Height of the Thread

In profile, the distance between the crest and bottom section of the thread measured normal to the axis

Helix Angle - Flute

Flutes of taps are sometimes cut helically instead of straight. This helix angle is the angle made by the flute with the axis of the tap. (Helical Flutes are commonly referred to as spiral flutes.)

Tooling

Recoil Tools

AFS supplies a range of associated Recoil tooling to facilitate Recoil insert installation. The advantage of the Recoil tooling system is its simplicity, versatility, and ease of use. The hand installation tooling range includes the manual installation tool, the semi production "Prewinder" type, as well as manual and spring operated tang break off tools.

Trade Series Kit

Recoil's innovative and cost-effective thread repair kits are utilized worldwide in industrial and automotive maintenance situations. Each kit contains:

- 1 New combo tap and installation tool - tap wrench no longer required
- 2 Magnetic Tang Break Tool - for easy tang removal in blind holes
- 3 H.S.S. Drill

Trade Series Kit/Pro XL



Spark Plug Kit

Spark plug kits have pilot nose taps for accurate self alignment eliminating the need for drilling. The table below denotes the Recoil Insert Kit part numbers for each available thread size together with details of insert quantities included with each thread repair kit.

Spark Plug Kit



Manual Installation Tool

The standard Recoil insert installation tool is the most practical and simple to use for general applications. This tool may be used to install 1D through to 3D length inserts, but care must be taken to ensure that the adjustable collar is correctly set to suit the particular type and length of the Recoil insert. If the collar is incorrectly set, the insert will not drive properly and the tool may slip off the tang as the insert enters the hole. For general use, the collar should be adjusted such that the insert tang is positioned mid-way along the slot with the insert coils compressed. This will allow the insert free movement to suit the parent material thread pitch during installation.

Manual Installation Tool



If the installation tool is used to break off the tang, then it must be lifted clear of the insert following installation and replaced into the insert at 90 degrees to its drive position. This ensures that the tool is correctly placed on the insert tang. Tap the tool sharply downward to produce a clean tang break.

Note: The manual installation tool is not recommended for the installation of locking inserts.

Note: Recoil manual tools are not recommended for use with other brands of wire thread inserts.

Square Drive Installation Tool with tap



* Tap Square is only suitable for non-ferrous alloys. Tap drive, tang break and drill only up to 1/2"

How to place the insert on the Hand Tool

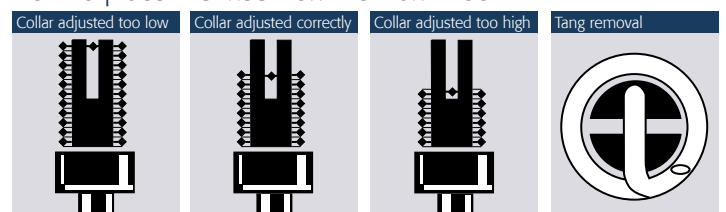

Tooling

Pre-Winder Installation Tools

This type of tool is ideal for installing inserts in small production runs or in areas where compressed air or electricity are not available and offers a quicker alternative to the simple hand installation tool. The tool is suitable for use when installing free running and locking inserts.

The mandrel is wound into the insert which is then installed into the tapped hole. During installation the insert diameter is reduced when passing through the bottom of the prewinder tool chamber making it easier to install. The mandrel is removed by turning the crank in a counter clockwise direction, leaving the insert in place.

Threaded Mandrel Type

The threaded mandrel type is suitable for the installation of free running and locking inserts. The mandrel is wound into the insert which is then wound into the tapped hole. The mandrel is removed by turning the crank in a counter clockwise direction, leaving the insert in place.

Note: The threaded mandrel type installation tool is recommended for installing locking inserts.

Recoil Tang Break Off Tools

Tang break off tools are available in hand, semi automatic spring type and pneumatic. The spring loaded and pneumatic tang break tools are recommended for removal of tangs in production applications. For large diameter fine thread inserts, e.g. M18-1.5 and above, 3/4- 16 and above, the use of long nose pliers is an alternative method to break the tang.

Manual Tang Break Tool

The simple Recoil manual magnetic tang removal tool is suitable for low volume tang removal and is used for insert sizes up to 1/2" or M12. The magnet allows for easy retrieval of the tang.

On larger sizes the multipurpose Recoil installation and tang break tool should be used. For tang removal, the tool is simply lifted and turned 90°, which will put the slot at right angles to the tang, then pushed downward with a sharp blow.

Spring Loaded Tang Break Tool

Spring loaded tang break tools offer effective removal of insert tangs and are suited from medium to large insert usage. Being spring loaded this tool requires no external power source and is suitable for tang removal on insert sizes up to 1/2" or M12. This tool is a spring loaded punch and when the tool is pushed down, the pin punches downward breaking off the tang.

Semi Production 'Pre-Winder' Type Installation Tool - Plastic Body



Semi Production 'Pre-Winder' Type Installation Tool - Metal Body



Magnetic Tang Break Tool



Spring Loaded Tang Break Tool



Tooling

Pneumatic Tang Break Tool

The pneumatic tang break tool is designed for high volume applications where rapid, effortless tang removal is required on insert sizes up to 3/4" or M20. This tool works on the same basis as the spring loaded tool, except the pin punches downward when an air cylinder is actuated by the valve.

Pneumatic Tang Break Tool



INSERT PART	MANUAL TANG BREAK	SPRING (ATBO) TYPE	PNEUMATIC TYPE
2-56, M2, M2.2	59060M	59061	59062
3-48, 3-56, M2.5	59070M	59071	59072
4-40, 4-48	59080M	59081	59082
5-40, M3	59090M	59091	59092
6-32, 6-40, M3.5	59100M	59101	59102
8-32, 8-36, M4	59130M	59121	59132
10-24, 12-24	59140M	59141	59142
10-32, M5	59160M	59141	59142
1/4-20, 1/4-28, M6	59190M	59181	59192
5/16-18	59220M	59241	59252
5/16-24, M8	59250M	59291	59252
3/8-16, M10-1.5	59280M	59291	59252
3/8-24, M10-1.25	59310M	59291	59252
7/16-14, 7/16-20, M11-1.25	59340M		
1/2-12, 1/2-13, M12-1.75	59380M		59332
M14-1.5			59462

Tooling

Extraction Tool

Should inserts need to be removed, the use of the Recoil extraction tool is recommended. Extraction tools are simple and easy to use. As correct positioning will make the extraction easier, the tool should be turned 90° from the start of the coil allowing easy winding out of the insert. If the extraction tool is not gripping the insert, the edges can be resharpened.

Size	Size of extraction tool and related size inserts		
	Inch	Metric	Part No.
No.2	4-40 - 3/8	M3 - M10	50002
No.3	6-32 - 1	M4 - M24	50003
No.4	1 1/8 - 1/2	M27 - M39	50004
No.5	1 1/2 - 2 1/2	M8 - M65	50005

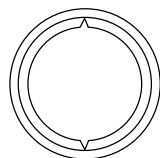
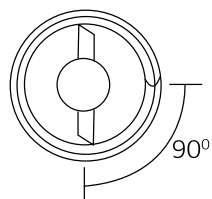

Should the extracting tool not grip the insert, file a small notch in the insert for the tool to bite into.



Recoil Thread Gauges

Thread gauging is recommended wherever precision threads are required. The quality of the tapped hole which accommodates the insert determines the finished size and hole quality after the insert has been installed. If the finished tapped hole gauges satisfactorily, the installed insert will be within the thread tolerance.

Technical Information

Recoil gauges 1/2" M12 and below have at least a .0002" or 5um wear allowance on the Go nib. Gauge handle and all gauge nibs are marked with the extreme product limits for particular size and class of fit. Where precision is required, 3B gauges should be used. When using locking inserts, 3B gauges should be used as close precision is required.

Fits and Tolerances

Recoil gauges are supplied for two different classes of fit (tolerances). These are close and medium tolerance. Gauges are used to check the pitch diameter of the tapped hole; the "NoGo" end of the gauge checks the pitch diameter is not too large and the "Go" end checks the pitch diameter is not too small.

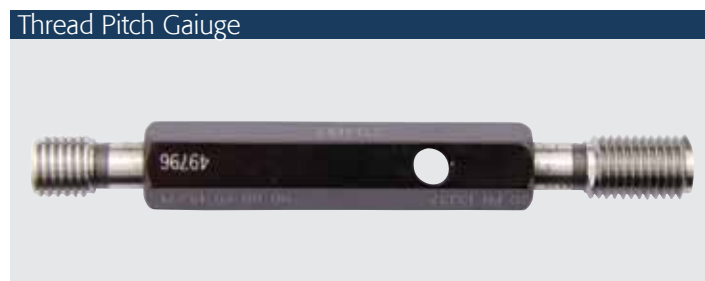

THREAD / TOLERANCE	CLOSE	MEDIUM
Metric	4H5H	5H
UN	3B	2B
Imperial	CLOSE	MEDIUM

Recoil Kits/Tools Metric

Thread Size/Pitch	Kits	Installation Tools	Production Insertion Tools			Electric Mandrels	Tangbreak Tools	Extraction Tool	Gauges	
			Pre-Winder	Light-Winder	Non-Captive				4H5H Tol.	5H MED
*M2 - 0.4	35028	50061-20				55027B	59060M	50002	65024	65025
*M2.2 - 0.45	35018	50061-21	55011				59060M	50002	65014	65015
*M2.5 - 0.45	35258	50069-17	55251			55257B	59070M	50002	65254	65255
*M3 - 0.5	35038	50089-17	55031	55032U		55037B	59090M	50002	65034	65035
*M3.5 - 0.6	35358	50095-15	55351				59100M	50002	65354	65355
*M4 - 0.7	35048	50125-13	55041	55042U		55047B	59130M	50003	65044	65045
*M5 - 0.8	35058	50156-9	55051	55052U		55057B	59160M	50003	65054	65055
*M6 - 1	35068	50188-5	55061	55062U		55067B	59190M	50003	65064	65065
*M7 - 1	35078	50219-4	55071				59220M	50003	65074	65075
M8 - 0.75	N/A	50250-0						50003		
*M8 - 1	37088	50250-7	57081				59250M	50003	67084	67085
*M8 - 1.25	35088	50250-7	55081	55082U		55087B	59250M	50003	65084	65085
*M9 - 1	37098	50281-5					59280M	50003	67094	67095
*M9 - 1.25	35098	50281-5					59280M	50003	65094	65095
*M10 - 1	38108	50313-12	58101			58107B	59310M	50003		
*M10 - 1.25	37108	50281-4	57101	57102U			59310M	50003	67104	67105
*M10 - 1.5	35108	50281-4	55101	55102U			59280M	50003	65104	65105
*M11 - 1	38118	50344-4					59340M	50003	68114	68115
*M11 - 1.25	37118	50344-4					59340M	50003	67114	67115
*M11 - 1.5	35118	50344-4					59340M	50003	65114	65115
*M12 - 1	N/A	50375-0								
*M12 - 1.25	38128	50375-1	58121				59380M	50003		
*M12 - 1.5	37128	50375-1	57121	57122U		57127B	59380M	50003	67124	67125
*M12 - 1.75	35128	50375-1	55121	55122U		55127B	59380M	50003	65124	65125
M13 - 1.25	38138	50375-0						50003	68134	68135
M13 - 1.5	37138	50375-0						50003	67134	67135
M13 - 1.75	35138	50375-0						50003	65134	65135
M14 - 1.25	38148-1	50468-0						50003		
M14 - 1.5	37148	50438-0	57141					50003	67144	67145
M14 - 2	35148	50438-0	55146					50003	65144	65145
M15 - 1.5	37150	50438-0						50003	67154	67155
M15 - 2	35158	50438-0						50003	65154	65155
M16 - 1.5	37168	50500-0			57161			50003	67164	67165
M16 - 2	35168	50500-0	55166		55161			50003	65164	65165
M18 - 1.5	38188-1	50591-0	57181					50003		
M18 - 2	37188	50591-0						50003	67184	67185
M18 - 2.5	35188	50591-0	55186					50003	65184	65185
M20 - 1.5	38200	50591-0						50004	68204	68205
M20 - 2	37208	50591-0						50004	67204	67205
M20 - 2.5	35208	50591-0						50004	65204	65205
M22 - 1.5	38220	50688						50004	68224	68225
M22 - 2	37220	50688						50004	67224	67225
M22 - 2.5	35220	50688						50004	65224	65225
M24 - 1.5	38240	50750						50004	68244	68245
M24 - 2	37240	50750						50004	67244	67245
M24 - 3	35240	50750						50004	65244	65245
M26 - 1.5	38260	50875						50004	68264	68265
M27 - 1.5	38270	50875						50004	68274	68275
M27 - 2	37270	50875							67274	67305
M27 - 3	35270	50875							65274	65275
M30 - 1.5	38300	51000							68304	68305
M30 - 2	37300	51000							67304	67305
M30 - 3	35300-3	51000							65304-3	65305-3
M30 - 3.5	35300	51000							65304	65305
M33 - 2	37330	51063								
M33 - 3.5	35330	51063								
M36 - 1.5	38360	51125							68364	68365

* Drill and magnetic tangbreak tool included

Recoil Kits/Tools Metric

Thread Size/Pitch	Kits	Installation Tools	Production Insertion Tools			Electric Mandrels	Tangbreak Tools	Extraction Tool	Gauges	
			Pre- Winder	Light - Winder	Non - Captive				4H5H Tol.	5H MED
M36 - 3	37360	51125								
M36 - 4	35360	51125							65364	65365
M39 - 2	38390	51250							68394	68395
M39 - 3	37390	51250							67394	67395
M39 - 4	35390	51250							65394	65395
M42 - 2	38420	51250							68424	68425
M42 - 3	37420	51250							67424	67425
M42 - 4	35420-4	51250							65424-4	65425-4
M42 - 4.5	35420	51250								
M45 - 3	N/A	51250								
M45 - 4.5	35450	51250							65424	65425
M48 - 3	N/A	51500								
M48 - 4	N/A	51500								
M48 - 5	N/A	51500								
M52 - 3	N/A	51500								
M52 - 5	N/A	51500								

Recoil Kits/Tools Unified

Thread Size/Pitch UNC	Kits	Installation Tools	Production Insertion Tools			Electric Mandrels	Tangbreak Tools	Extraction Tool	Gauges	
			Pre- Winder	Mandrel	Light - Weight				Non - Captive	3BCLOSE
*#2 - 56	33528	50061-17	53521		53522U	53527B	59060M		63523	63522
*#3 - 48	33538	50069-17	53531	53536	53532U		59070M		63533	63532
*#4 - 40	33548	50077-17	53541		53542U	53547B	59100M	50002	63543	63542
*#5 - 40	33558	50089-18	53551		53542U		59090M	50002	63553	63552
*#6 - 32	33568	50095-16	53561		53562U	53576B	59100M	50002	63563	63562
*#8 - 32	33588	50125-14	53581		53582U	53587B	59130M	50002	63583	63582
*#10 - 24	33608	50140-11	53601		53602U	53607B	59140M	50002	63603	63602
*#12 - 24	33628	50156-10	53621		53622U		59160M	50002	63623	63622
*1/4 - 20	33048	50188-10	53041		53042U	53047B	59190M	50002	63043	63042
*5/16 - 18	33058	50219-8	53051		53052U	53057B	59220M	50002	63053	63052
*3/8 - 16	33068	50281-4	53061		53062U	53067B	59280M	50002	63063	63062
*7/16 - 14	33078	50344-3	53071		53072U	53077B	59310M	50003	63073	63072
*1/2 - 13	33088	50375-2	53081		53082U	53087B	59380M	50003	63083	63082
9/16 - 12	33098	50438-0	53096	53096				50003	63093	63092
5/8 - 11	33108	50500-0	53106	53106				50003	63103	63102
11/16 - 11	33110	50500-0						50003	63113	63112
3/4 - 10	33128	50591-0	53126	53126				50003	63123	63122
7/8 - 9	33140	50688	53146	53146				50003	63143	63142
1" - 8	33160	50750	53166	53166				50003	63163	63162
1 1/8 - 7	33180	50875	53186	53186				50004	63183	63182
1 1/4 - 7	33200	51000	53206	53206				50004	63203	63202
1 3/8 - 6	33220	51063	53226	53226				50004	63223	63222
1 1/2 - 6	33240	51125	53246	53246				50004	63243	63242

* Drill and magnetic tangbreak tool included

Recoil Kits/Tools Unified

Thread Size/Pitch UNF	Kits	Installation Tools	Pre- Winder	Production Insertion Tools			Electric Mandrels	Tangbreak Tools	Extraction Tool	Gauges	
				Mandrel	Light - Weight	Non - Captive				3BCLOSE	2BMED
*#3 - 56	34538	50069-17	54531				59070M	50002	64533	64532	
*#4 - 48	34548	50077-17	54541		54542U		59080M	50002	64543	64542	
*#6 - 40	34568	50095-17	54561		54562U		59100M	50002	64563	64562	
*#8 - 36	34588	50125-14	54581		54582U		59130M	50002	64583	64582	
*#10 - 32	34608	50156-11	54601		54602U	54607B	59160M	50002	64603	64602	
*#12 - 28	34628	50156-10					59160M	50002			
*1/4 - 28	34048	50188-10	54041		54042U	54047B	59190M	50002	64043	64042	
*5/16 - 24	34058	50250-8	54051		54052U	54057B	59250M	50002	64053	64052	
*3/8 - 24	34068	50313-6	54061		54062U	54067B	59280M	50002	64063	64062	
*7/16 - 20	34078	50344-4	54071		54072U	54077B	59310M	50003	64073	64072	
*1/2 - 20	34088	50375-3	54081		54082U	54087B	59380M	50003	64083	64082	
9/16 - 18	34098	50438-0	54091					50003	64093	64092	
5/8 - 18	34108	50500-0	54101					50003	64103	64102	
3/4 - 16	34128	50591-0	54121					50003	64123	64122	
7/8 - 14	34140	50688	54141					50003	64143	64142	
1" - 12	34160	50750	54161					50003	64163	64162	
1" - 14	34160-14	50750	54171					50003	64163-14	64162-14	
1 1/8 - 12	34180	51000	54181					50004	64183	64182	
1 1/4 - 12	34200	51063						50004	64203	64202	
1 3/8 - 12	34220	51125						50004	64223	64222	
1 1/2 - 12	34240	51250						50004	64243	64242	
BA											
	Kits	Tools									
*0BA	30508	50188-5					59190M	50002		60502	
*2BA	30528	50140-9					59140M	50002		60522	
*4BA	30548	50095-15					59100M	50002		60542	
*6BA	30568	50077-17					59070M	50002		60562	
BSC											
*5/16 - 26	36508	50250-4					59250M	50002		66502	
*3/8 - 26	36608	50313-5					59310M	50002		66602	
*7/16 - 26	36708	50344-4					59340M	50003		66702	
*1/2 - 26	36808	50375-1					59380M	50003		66802	
BSF											
*3/16 - 32	30038	50156-9					59160M	50002		60032	
*1/4 - 26	30048	50188-5					59190M	50002		60042	
*5/16 - 22	30058	50250-5					59250M	50002		60052	
*3/8 - 20	30068	50281-5					59280M	50002		60062	
*7/16 - 18	30078	50344-4					59340M	50003		60072	
*1/2 - 16	30088	50375-1					59380M	50003		60082	
9/16 - 16	30098	50438-0						50003		60092	
5/8 - 14	30108	50500-0						50003		60102	
3/4 - 12	30128	50591-0						50003		60122	
7/8 - 11	30140	50688						50003		60142	
1" - 10	30160	50750						50003		60162	
1 1/4 - 9	30200*	51000								60202	

* Drill and magnetic tangbreak tool included

Recoil Kits/Tools Unified

Thread Size/Pitch BSP	Kits	Installation Tools	Pre- Winder	Production Mandrel	Insertion Tools Light - Weight	Non - Captive	Electric Mandrels	Tangbreak Tools	Extraction Tool	Gauges 3BCLOSE	2BMED
*1/8 - 28	31028	50313-5						59310M	50002		61022
1/4 - 19	31048	50438-0							50002		61042
3/8 - 19	31068	50500-0							50002		61062
1/2 - 14	31080	50688							50003		64082
5/8 - 14	31100	50875							50003		61102
3/4 - 14	31120	51125							50003		61122
1" - 11	31160								50003		61162
BSW											
*1/8 - 40	32028	50089-19						59090M	50002		62022
*3/16 - 24	32038	50140-9						59140M	50002		62032
*1/4 - 20	32048	50188-5						59190M	50002		62042
*5/16 - 18	32058	50219-8						59200M	50002		62052
*3/8 - 16	32068	50281-4						59280M	50002		62062
*7/16 - 14	32078	50344-1						59340M	50003		62072
*1/2 - 12	32088	50375-1						59380M	50003		62082
9/16 - 12	32098	50438-0							50003		62092
5/8 - 11	32108	50500-0							50003		62102
3/4 - 10	32128	50591-0							50003		62122
7/8 - 9	32140	50688							50003		62142
1" - 8	32160	50750							50003		62162
1 1/8 - 7	32180	50875							50004		62182
1 1/4 - 7	32200	51000							50004		62202
1 3/8 - 6	32220	50875							50004		62222
1 1/2 - 6	32240	51125							50004		62242
NPT											
*1/8 - 27	36028	50313-1						59310M	50002		
1/4 - 18	36048	50438-0							50003		
3/8 - 18	36068	50500-0							50003		
1/2 - 14	36080	50688							50004		
3/4 - 14	36120	50875							50004		
1 - 11 1/2	36160	51125							50004		
8 TPI UN											
1 1/8 - 8	36180	50875							50004	66183	66182
1 1/4 - 8	36200	51000				56201			50004	66204	66202
1 3/8 - 8	36220	51063				56226			50004	66223	66222
1 1/2 - 8	36240	51125				56241			50004	66243	66242
1 5/8 - 8	36260	51250				56261			50005	66263	66262
1 3/4 - 8	36280	51250				56281			50005	66283	66282
1 7/8 - 8	36300	51500							50005	66303	66302
2" - 8	36320	51500				56321			50005	66323	66322
2 1/8 - 8	N/A					56341			50005		
2 1/4 - 8	N/A					56361			50005		
2 1/2 - 8	N/A	52125				56401			50005		
2 3/4 - 8	N/A					56441			50005		
3" - 8	N/A	52500				56481			50005		

Spark Plug Sizes	Kits
M10 - 1 SPK	38108-2
M12 - 1.25 SPK	38120-2
M14 - 1.25	38140
M14 - 1.25 SPK	38148-2
M18 - 1.5	38188

Contains 5 each x 3/4" and 3/8" spark plug inserts

Plugsaver Sizes	
M14 - 1.25 SPK	38148

Exhaust Analysis Size	
M18 - 1.5	38188-X

* Drill and magnetic tangbreak tool included

Production Installation Tooling

Power Tools

The Recoil range of power tooling ensures consistent high volume thread insert installation for a variety of applications. Recoil powered installation tools may be supplied for use with either a compressed air supply or via a stabilized low voltage power supply to suit your particular requirements. Both equipment types offer significant productivity gains for high volume insert use.

Pneumatic Power Tooling

- Wide thread size range #2-56 through 3/4", or M2.5 through M16, coarse and fine
- Rugged and versatile air motor
- May be used with captive strip feed or bulk insert insertion
- Standard speed 1500 rpm
- Auto reverse on release of trigger The complete pneumatic insert installation tool comprises three components:
 - Air motor with single lever control to install and retract
 - Adaptor - connect the motor to the insert drive nozzle - small and large types
 - Front end assembly nozzle to suit the particular insert thread size

Pneumatic Power Tool



Front End Assembly



Electric Power Tooling

- Size range #2-56 through 1/4", M2.5 through M8
- Auto reverse on installation
- Clean, lightweight, quiet
- Suitable for bulk insert only
- Easy Adjust Depth Control Collar
- Suitable for use with torque control
- Hardened Steel Hex Drive Mandrel screwdrivers

Electric Power Tool with Mandrel



Compressed Air Supply for Pneumatic Installation Tools chart

		PRESSURE RECOMMENDATIONS FOR INSERT SIZES									
Inch	#2 #4	#5	#6	#8 #10	1/4"	5/16"	3/8"	7/16"	1/2"		
Metric	M2 - 2.5, M2.5	M3	M3.5	M4, M5	M6, M7	M8	M10	-	M12		
RECOMMENDED PRESSURE											
psi	25	20-30	25-30	40	45	50-60	60	70	70-80	90	
bar	1.70	1.3-2.0	1.7-2.0	2.72	3.06	3.4-4.0	4.0	4.76	4.7-5.4	6.0	
MPa	0.172	0.138-0.206	0.172-0.206	0.275	0.310	.344-0.413	0.413	0.482	0.482-0.551	0.620	

If difficulty is encountered within the above settings, reduce the pressure until the optimum setting is found. It is imperative that a regulated moisture-free and filtered air supply is used with all Recoil pneumatic tooling. Reliability will be affected if an adequate and regulated air supply is not used with these tools. Guidelines for typical Recoil insert tool pressure requirements are shown above.

Strip-Feed Inserts

To complete the Recoil power installation tools, Recoil has inserts available on strip (M2.5-M12, #2-5/16) to optimize production with increased installation cycles and reduced operator fatigue. Recoil strip feed inserts provide many advantages such as minimized handling costs, faster, more economical assembly and positive inventory control. When used in combination with Recoil pneumatic installation tooling, each insert is retained in plastic strip which is passed through a slot in the front end assembly nozzle, indexing the insert to the installation mandrel. Recoil Strip-Feed inserts are available in most common thread diameters and lengths in addition to the various surface finishes which are available on standard Recoil bulk inserts. The table shows some commonly supplied Recoil Strip-Feed inserts and defines the typical quantity of inserts supplied per reel for each given thread size. Additional insert diameters and lengths may be available to special order.



Electric Mandrel Specifications Metric

Electric Mandrel Metric																
Size	Part No.	OD (mm)	OD (inch)	Thread Length (mm)	Thread Length (inch)	Collar OD (mm)	Collar OD (inch)	Approx Collar Length (mm)	Approx Collar Length (inch)	Shaft Length (mm)	Shaft Length (inch)	Hex Length (mm)	Hex Length (inch)	Hex Drive	Overall Length (mm)	Overall Length (inch)
M2 x 0.4	55027B	2.05	0.080	13	0.512	6	0.236	25.5	1.004	35	1.378	25.6	1.008	1/4"	73.5	2.894
M2 x 0.45	55257B	2.5	0.098	13	0.512	6	0.236	25.5	1.004	35	1.378	25.6	1.008	1/4"	73.5	2.894
M3 x 0.5	55037B	2.85	0.112	13	0.512	6	0.236	25.5	1.004	35	1.378	25.6	1.008	1/4"	73.5	2.894
M4 x 0.7	55047B	3.7	0.145	15	0.591	10	0.394	25	0.984	45	1.772	25.6	1.008	1/4"	85.5	3.366
M5 x 0.8	55057B	4.7	0.185	25	0.984	10	0.394	33	1.299	43.5	1.713	25.6	1.008	1/4"	94	3.701
M6 x 1.0	55067B	5.75	0.226	25	0.984	10	0.394	33	1.299	43.5	1.713	25.6	1.008	1/4"	94	3.701
M8 x 1.25	55087B	7.2	0.283	25	0.984	14	0.551	35	1.378	43.5	1.713	25.6	1.008	1/4"	94	3.701
M10 x 1.0	58107B	9.75	0.383	35	1.378	16	0.630	37	1.457	40.5	1.594	25.6	1.008	1/4"	101	3.976
M10 x 1.25	57107B	9.75	0.383	35	1.378	16	0.630	37	1.457	40.5	1.594	25.6	1.008	1/4"	101	3.976
M10 x 1.5	55107B	9.35	0.368	35	1.378	16	0.630	37	1.457	40.5	1.594	25.6	1.008	1/4"	101	3.976
M12 x 1.5	57127B	11.55	0.454	40	1.575	18	0.709	45	1.772	45.5	1.791	25.6	1.008	1/4"	111	4.370
M12 x 1.75	55127B	11.6	0.456	40	1.575	18	0.709	45	1.772	45.5	1.791	25.6	1.008	1/4"	111	4.370

Electric Mandrel UNC																
Size	Part No.	OD (mm)	OD (inch)	Thread Length (mm)	Thread Length (inch)	Collar OD (mm)	Collar OD (inch)	Approx Collar Length (mm)	Approx Collar Length (inch)	Shaft Length (mm)	Shaft Length (inch)	Hex Length (mm)	Hex Length (inch)	Hex Drive	Overall Length (mm)	Overall Length (inch)
UNC #2-56	53527B	2.15	0.085"	15	0.591	6	0.236	25.5	1.004	43.5	1.713	25.6	1.008	1/4"	84	3.307
UNC #4-40	53547B	2.7	0.106"	15	0.591	6	0.236	24.5	0.965	43.5	1.713	25.6	1.008	1/4"	84	3.307
UNC #6-32	53567B	3.2	0.128"	16	0.630	6	0.236	25.6	1.008	43.5	1.713	25.6	1.008	1/4"	85	3.346
UNC #8-32	53587B	3.9	0.154"	18	0.709	10	0.394	30	1.181	43.5	1.713	25.6	1.008	1/4"	87	3.425
UNC #10-24	53607B	4.5	0.177"	18	0.709	10	0.394	30	1.181	43.5	1.713	25.6	1.008	1/4"	87	3.425
UNC 1/4-20	53047B	6.2	0.244"	26	1.024	14	0.551	35	1.378	40.5	1.594	25.6	1.008	1/4"	92	3.622
UNC 5/16-18	53057B	7.3	0.287"	25	0.984	14	0.551	35	1.378	36.5	1.437	25.6	1.008	1/4"	87	3.429
UNC 3/8-16	53067B	9.1	0.358"	35	1.378	16	0.630	41	1.614	45.5	1.791	25.6	1.008	1/4"	106	4.177
UNC 7/16-20	53077B	10.5	0.413"	38	1.496	16	0.630	43	1.693	42.5	1.673	25.6	1.008	1/4"	106	4.177
UNC 1/2-13	53087B	12.1	0.476"	45	1.772	18	0.709	45	1.772	45.5	1.791	25.6	1.008	1/4"	116	4.571

Dimensions are reference only

Electric Mandrel Specifications Unified

Electric Mandrel UNF															
Size	Part No.	OD (mm)	OD (inch)	Thread Length (mm)	Thread Length (inch)	Collar OD (mm)	Collar OD (inch)	Approx Collar Length (mm)	Approx Collar Length (inch)	Shaft Length (mm)	Shaft Length (inch)	Hex Drive Length (mm)	Hex Drive Length (inch)	Overall Length (mm)	Overall Length (inch)
UNC #10-32	54607B	4.5	0.177	21	0.827	10	0.394	35	1.378	35	1.378	25.6	1.008	81.5	3.209
UNC 1/4-28	54047B	6.3	0.248	25	0.984	14	0.551	37	1.457	36.5	1.437	25.6	1.008	87	3.425
UNC 5/16-24	54057B	7.4	0.291	25	0.984	14	0.551	35	1.378	40	1.575	25.6	1.008	90.5	3.563
UNC 3/8-24	54067B	8.9	0.350	35	1.378	16	0.630	41	1.614	40.5	1.594	25.6	1.008	101.5	3.996
UNC 7/16-20	54077B	10.9	0.429	41	1.614	18	0.709	43	1.693	42	1.654	25.6	1.008	108.5	4.272
UNC 1/2-20	54087B	12.3	0.484	45	1.772	18	0.709	45	1.772	40.5	1.594	25.6	1.008	111	4.370

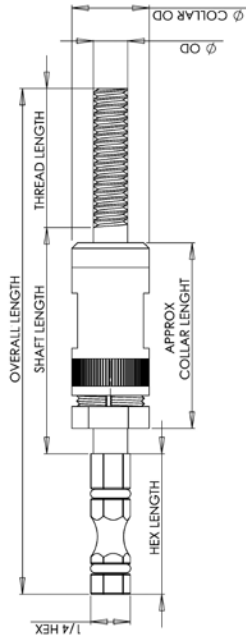

Part No. HR-HL 1410											
Size	A	B	C	D	E	F	G	H			
1/2-20	Ø20	71	Ø25	230mm	BSP 1/8-28	Ø29	Ø33	Ø40			
1/2-13	Ø20	71	Ø25	230mm	BSP 1/8-28	Ø29	Ø33	Ø40			
7/16-20	Ø20	65	Ø25	230mm	BSP 1/8-28	Ø29	Ø33	Ø40			
7/16-14	Ø20	65	Ø25	230mm	BSP 1/8-28	Ø29	Ø33	Ø40			
3/8-24	Ø17.5	55	Ø22.5	230mm	BSP 1/8-28	Ø29	Ø33	Ø40			
3/8-16	Ø17.5	55	Ø22.5	230mm	BSP 1/8-28	Ø29	Ø33	Ø40			
5/16-24	Ø15	50	Ø20	230mm	BSP 1/8-28	Ø29	Ø33	Ø40			
5/16-18	Ø15	50	Ø20	230mm	BSP 1/8-28	Ø29	Ø33	Ø40			
M12x1.75	Ø20	71	Ø25	230mm	BSP 1/8-28	Ø29	Ø33	Ø40			
M10x1.5	Ø17.5	55	Ø22.5	230mm	BSP 1/8-28	Ø29	Ø33	Ø40			
M8x1.25	Ø15	50	Ø20	230mm	BSP 1/8-28	Ø29	Ø33	Ø40			

Part No. HR-HL 1409											
Size	A	B	C	D	E	F	G	H			
1/4-28	Ø11	41.5	Ø16	217mm	BSP 1/8-28	Ø28	Ø26	Ø29.5			
10-32	Ø9.5	41.5	Ø18.5	217mm	BSP 1/8-28	Ø28	Ø26	Ø29.5			
1/4-20	Ø11	41.5	Ø16	217mm	BSP 1/8-28	Ø28	Ø26	Ø29.5			
#10-24	Ø9.5	41.5	Ø18.5	217mm	BSP 1/8-28	Ø28	Ø26	Ø29.5			
#8-32	Ø8	41.5	Ø18.5	217mm	BSP 1/8-28	Ø28	Ø26	Ø29.5			
#6-32	Ø8	41.5	Ø18	217mm	BSP 1/8-28	Ø28	Ø26	Ø29.5			
#4-40	Ø6	41.5	Ø16	217mm	BSP 1/8-28	Ø28	Ø26	Ø29.5			
M6x1	Ø11	41.5	Ø16	217mm	BSP 1/8-28	Ø28	Ø26	Ø29.5			
M5x0.8	Ø10	41.5	Ø18.5	217mm	BSP 1/8-28	Ø28	Ø26	Ø29.5			
M4x0.7	Ø8	41.5	Ø18.5	217mm	BSP 1/8-28	Ø28	Ø26	Ø29.5			
M30.5	Ø6	41.5	Ø16	217mm	BSP 1/8-28	Ø28	Ø26	Ø29.5			

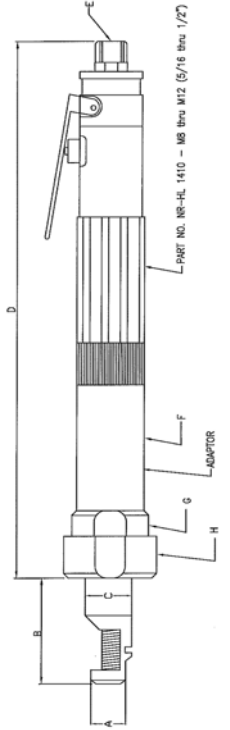
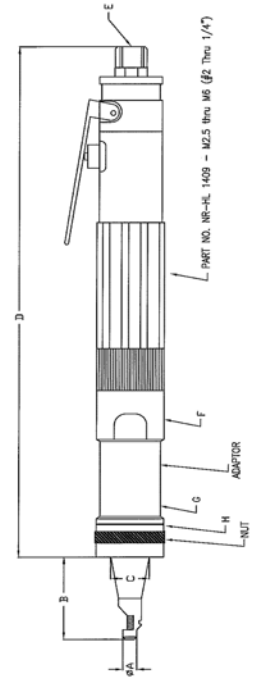

Pneumatic Installation Tooling

The following table denotes the part numbers of all pneumatic installation tooling for the most popular thread size ranges.

SUIT ARO & NR SERIES FRONT END ASSEMBLY		SPARES FOR FRONT END ASSEMBLY			
SIZE	PART NO.	NR MOTOR & ADAPTOR PART NO.	FRONT END ASSEMBLY SIZE	NOZZLE	MANDREL
METRIC COARSE			METRIC COARSE		
2.2 - .45	55250	NR-HL 1409	2.2 - 0.45	55258	55259
2.5 - .45	55250	NR-HL 1409	2.5 - 0.45	55258	55259
3 - 0.5	M8751-3-15	NR-HL 1409	3 - 0.5	M8769-3-15	M8757-3
3.5 - 0.6	M8751-3.5-15	NR-HL 1409	3.5 - 0.6	M8769-3.5-15	M8757-3.5
4 - 0.7	M8751-4-15	NR-HL 1409	4 - 0.7	M8769-4-15	M8757-4
5 - 0.8	M8751-5-15	NR-HL 1409	5 - 0.8	M8769-5-15	M8757-5
6 - 1	M8751-6-15	NR-HL 1409	6 - 1	M8769-6-15	M8757-6
7 - 1	55070	NR-HL 1410	7 - 1	55078	55079
8 - 1.25	M8751-8-15	NR-HL 1410	8 - 1.25	M8769-8-15	M8757-8
10 - 1.5	M8751-10-15	NR-HL 1410	10 - 1.5	M8769-10-15	M8757-10
12 - 1.75	M8751-12-15	NR-HL 1410	12 - 1.75	M8769-12-15	M8757-12
16 - 2	55160	NR-HL 1410	16 - 2	55168	55169

METRIC FINE		METRIC FINE			
SIZE	PART NO.	NR MOTOR & ADAPTOR PART NO.	FRONT END ASSEMBLY SIZE	NOZZLE	MANDREL
8 - 1	57080	NR-HL 1410	8 - 1	57088	57089
10 - 1	58100	NR-HL 1410	10 - 1	58108	58109
10 - 1.25	57100	NR-HL 1410	10 - 1.25	57108	57109
12 - 1.25	58120	NR-HL 1410	12 - 1.25	58128	58129
12 - 1.5	57120	NR-HL 1410	12 - 1.5	57128	57129
14 - 1.5	M8753-14	NR-HL 1410	14 - 1.5	M8773-14	M8774-14

UNC		UNC			
SIZE	PART NO.	NR MOTOR & ADAPTOR PART NO.	FRONT END ASSEMBLY SIZE	NOZZLE	MANDREL
2 - 56	53520	NR-HL 1409	2 - 56	53528	53529
4 - 40	M8551-04-15	NR-HL 1409	4 - 40	M8557-04-15	M8553-04
5 - 40	M8851-05-15	NR-HL 1409	5 - 40	M8557-05-15	M8553-05
6 - 32	M8551-06-15	NR-HL 1409	6 - 32	M8557-06-15	M8553-06
8 - 32	M8551-2-15	NR-HL 1409	8 - 32	M8557-2-15	M8553-2
10 - 24	M8551-3-15	NR-HL 1409	10 - 24	M8557-3-15	M8553-3
1/4 - 20	M8551-4-15	NR-HL 1409	1/4 - 20	M8557-4-15	M8553-4
5/16-18	M8251-5-15	NR-HL 1410	5/16-18	M8257-5-15	M8253-5
3/8 - 16	M8251-6-16	NR-HL 1410	3/8 - 16	M8257-6-15	M8253-6
7/16 - 14	M8251-7-15	NR-HL 1410	7/16 - 14	M8257-7-15	M8253-7
1/2 - 13	M8251-8-15	NR-HL 1410	1/2 - 13	M8257-8-15	M8253-8
5/8 - 11	53100	NR-HL 1410	5/8 - 11	53108	53109
3/4 - 10	53120	NR-HL 1410	3/4 - 10	53128	53129

UNF		UNF			
SIZE	PART NO.	NR MOTOR & ADAPTOR PART NO.	FRONT END ASSEMBLY SIZE	NOZZLE	MANDREL
6 - 40	54560	NR-HL 1409	6 - 40	54568	54569
10 - 32	M8552-3-15	NR-HL 1409	10 - 32	M8558-3-15	M8554-3
1/4 - 28	M8552-4-15	NR-HL 1409	1/4 - 28	M8558-4-15	M8554-4
5/16 - 24	M8252-5-15	NR-HL 1410	5/16 - 24	M8258-5-15	M8254-5
3/8 - 24	54060	NR-HL 1410	3/8 - 24	54068	54069
7/16 - 20	M8252-7-15	NR-HL 1410	7/16 - 20	M8258-7-15	M8254-7
1/2 - 20	M8252-8-15	NR-HL 1410	1/2 - 20	M8258-8-15	M8254-8
5/8 - 18	M8252-9	NR-HL 1410	5/8 - 18	M8258-9	M8254-9
3/4 - 16	54120	NR-HL 1410	3/4 - 16	54128	54129

Design Considerations

The following design considerations should be evaluated to maximize the security and safety of the fastening assembly using Recoil wire inserts.

Boss Dimensions

Boss thickness is a function of size and strength requirements and also design of components. For optimum strength, the minimum wall thickness should be twice the maximum diameter of the STI Recoil Tap. For minimum requirements, a wall thickness of twice the bolt diameter to center line may be adequate.

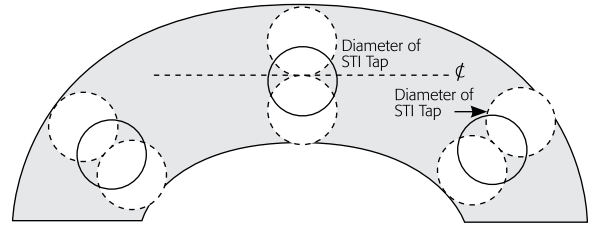

Edge Dimensions

The minimum edge distance recommended is the maximum diameter of the STI tap measured from the edge of the material to the center-line of the hole.

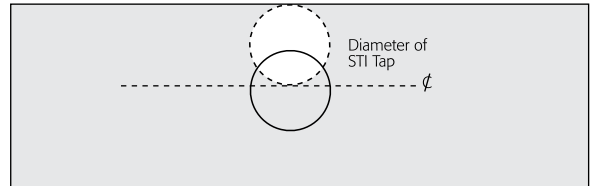

Minimum Material Thickness

The recommended minimum material thickness for through-hole applications is equal to the nominal length of the insert plus one pitch. This allows for proper countersinking and installation of the insert at 3/4 to 1-1/2 pitches below the surface of the component. In design critical applications, the minimum thickness may be reduced by eliminating the countersink and installing the insert to 1/4 to 1/2 pitch below the surface.

Class of Thread Fit

All Recoil inserts are produced to exacting tolerances where installation into the tapped hole will conform exactly to the parent material thread characteristics. It is therefore important that the tapped hole tolerances of either 2B or 3B (unified threads), or the applicable 4H5H and 5H (metric threads) combinations must be carefully controlled by precise tapping and gauging operations.

Gauging

Recoil inserts, when installed correctly in tapped and gauged holes, will conform with the tapped hole dimensions once the insert has been seated. Gauging of the tapped hole with the appropriate gauges prior to installing Recoil inserts is therefore highly recommended.

Bolt Engagement

Maximum strength of the bolted insert assembly will be achieved if the bolt or screw engages the full length of the insert. Ideally, the minimum bolt projection for safe engagement should be at least two pitches beyond the last coil of the insert.

Tang Removal

To achieve the optimum bolt engagement and hence maximum strength, the tang should be removed from the insert. Exceptions to this recommendation may be necessary in certain blind-hole applications involving light tensile bolt loading.

Thread Pitch/T.P.I.

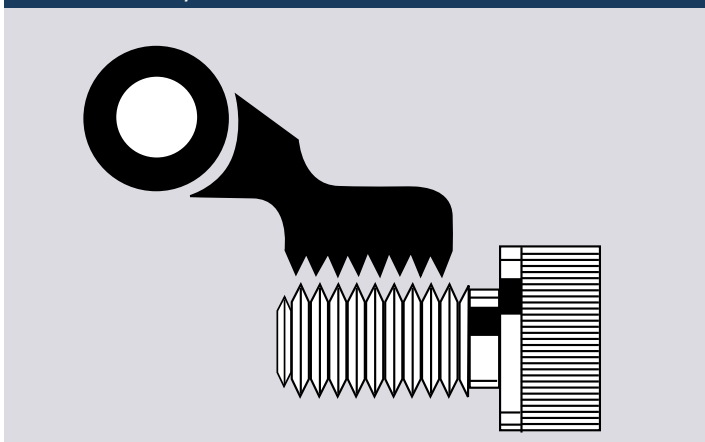

Thread Identification

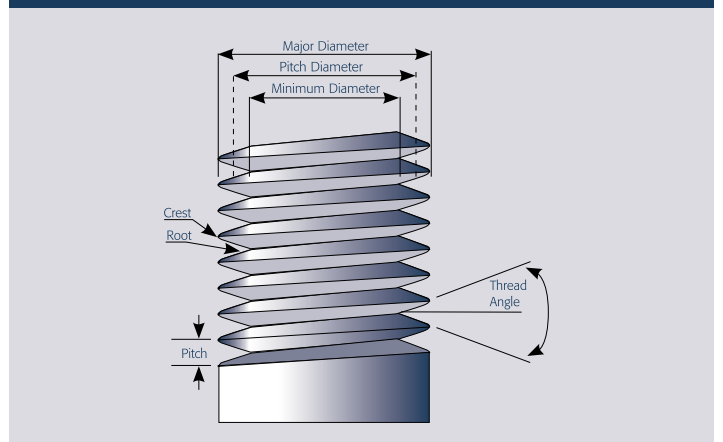

Assembly Design

Design Method

The ultimate consideration is to design an assembly that balances the tensile strength of the bolt material against the shear strength of the parent material. With insert lengths available in 1, 1-1/2, 2, 2-1/2, and 3 times the nominal thread diameters, there are engagement lengths available to produce an assembly thread system where the bolt will fail without damage to the parent material or thread. The bolt must be fully engaged along the entire length of the insert to obtain this position.

Selection of the correct length insert can be determined from Table 1 referring to values for bolt ultimate strengths and parent material shear strengths. For intermediate strength value, use the next higher bolt tensile value or the next lower parent material shear strength.

Assembly strength is a function of shear area and the shear strength of the parent material, tensile strength and cross sectional area of the bolt. Table 1 provides a recommendation of the nominal length of insert which should be selected for a parent material of a certain shear strength, so that when a bolt is used with defined tensile properties, tensile failure of the bolt should occur before the insert is stripped away from the material in which it was inserted.

SHEAR STRENGTH PARENT MATERIAL	TENSILE STRENGTH OF BOLT SELECTED (Ultimate Tensile Strength)						
	400 (MPa) 58,000 (psi)	500 (MPa) 72,000 (psi)	600 (MPa) 87,000 (psi)	800 (MPa) 116,000 (psi)	1000 (MPa) 145,000 (psi)	1200 (MPa) 174,000 (psi)	1400 (MPa) 203,000 (psi)
70 to 99 MPa (10.0 to 14.4 Ksi)	2.0D	2.5D	2.5D	-	-	-	-
100 to 149 MPa (14.5 to 21.5 Ksi)	1.5D	1.5D	2.0D	3.0D	-	-	-
150 to 199 MPa (21.7 to 28.9 Ksi)	1.0D	1.5D	1.5D	2.0D	2.5D	3.0D	-
200 to 249 MPa (29.0 to 36.1 Ksi)	1.0D	1.0D	1.0D	1.5D	2.0D	2.0D	2.5D
250 to 299 MPa (36.2 to 43.3 Ksi)	1.0D	1.0D	1.0D	1.5D	1.5D	2.0D	2.0D
300 to 349 MPa (43.5 to 50.6 Ksi)	1.0D	1.0D	1.0D	1.0D	1.5D	1.5D	2.0D
> 350 MPa (50.7 Ksi)	1.0D	1.0D	1.0D	1.0D	1.0D	1.5D	1.5D

Note: Inserts are available in different lengths which are measured by the diameter of the thread. For example the length of a 3D insert would be three times the diameter. Note: Table 1 is for guidance only. It remains the responsibility of the user to ensure that the insert nominal length chosen is suitable for the particular application concerned.

Design Method

The following procedure can be used to verify a joint design incorporating a wire thread insert:

1. Select size and strength of bolt to be used (refer to table 2).
2. Determine tensile failure load of the selected bolt.
3. Determine shear strength of parent material for the installation of the insert (refer to table 3).
4. Determine length of insert based on the shear strength capability of parent material.

Note: Information in referring to joint strength is intended as a guide only. Professional engineering advice must be sought when exact design calculations are required.

Design Example (Metric) Units		Design Example (Inch) Units	
Step One: Select size and strength of bolt to be used			
Type	M16 x 2.0, SAE Grade 8	Type	1/2-13 UNC Socket Head Cap Screw
Nominal Diameter	16.0 mm	Nominal Diameter	0.500 "
Pitch	2.0 mm	TPI	13
Shear Strength	1034 MPa (refer table 2)	Tensile Strength	181,000psi (refer table 2)

Assembly Design

Table 2 Strength, Bolt (Metric)

BOLT GRADE (minimum)	Tensile Strength Mpa
SAE Grade 1 1/4 to 1"	413
SAE Grade 5 1/4 to 1 1/2"	827
SAE Grade 7 1/4 to 1 1/2"	917
SAE Grade 8 1/4 to 1 1/2"	1034
ASTM A354	
BC 1/4 to 2 1/2"	862
BD 1/4 to 2 1/2"	1034
Socket head screw products	1250

Step Two: Determine tensile failure load of selected bolt

Min Thread Diameter	13.797mm (handbook)
Shear Area	149.5mm ² (calculated)*
Tensile Failure Load	154.59kN (calculated)#

***Area based on minor thread diameter.**

#Parent material shear strength must exceed this.

Table 2 Strength, Bolt (Metric)

BOLT GRADE (minimum)	Tensile Strength Mpa
SAE Grade 1 1/4 to 1" "	60,000
SAE Grade 5 1/4 to 1 1/2" "	120,000
SAE Grade 7 1/4 to 1 1/2" "	133,000
SAE Grade 8 1/4 to 1 1/2" "	150,000
ASTM A354	
BC 1/4 to 2 1/2" "	125,000
BD 1/4 to 2 1/2" "	150,000
Socket head screw products	181,000

Min Thread Diameter	0.407" (handbook)
Shear Area	0.130" (calculated)*
Tensile Failure Load	23,550 Pounds Force (lbf) (calculated)#

***Area based on minor thread diameter.**

#Parent material shear strength must exceed this.

Step Three: Determine shear strength of parent material for the installation of the insert (refer table 3)

Type	2024 Wrought Aluminum, T62 temper
Shear Strength	283 MPa (refer table 3)

Type	5083 Wrought Aluminum, annealed Condition
Shear Strength	25,000 psi (refer table 3)

Table 3 Shear Strength, Parent Material (Metric)

ALLOY	TEMPER	SHEAR STRENGTH PMa (typical)
SHEET & PLATE		
1200	0	62
2024	T62	283
5005	H34	97
5251	H34	138
5083	0	172
5083	H321	179
7075	T6	331
EXTRUSIONS (including machine rod)		
1350	H112	55
2011	T3	221
2011	T6	234
2014	T6	290
6060	T5	117
6061	T6	207
CASTINGS (Properties refer to test bars only)		
CA401 {LM6+ A413#}	F1-Sand	125
Heat Treating Alloy		
AC601 {LM25+ A356#}	T6-Sand	125
AC601 {LM25+ A356#}	T5-Sand	180
AC601 {LM25+ A356#}	T6-Perm	190

Table 3 Shear Strength, Parent Material (Inch)

ALLOY	TEMPER	SHEAR STRENGTH PMa (typical)
SHEET & PLATE		
1200	0	9,000
2024	T62	41,000
5005	H34	14,000
5251	H34	20,000
5083	0	25,000
5083	H321	26,000
7075	T6	48,000
EXTRUSIONS (including machine rod)		
1350	H112	8,000
2011	T3	32,000
2011	T6	34,000
2014	T6	42,000
6060	T5	17,000
6061	T6	30,000
CASTINGS (Properties refer to test bars only)		
CA401 {LM6+ A413#}	F1-Sand	18,000
Heat Treating Alloy		
AC601 {LM25+ A356#}	T6-Sand	18,000
AC601 {LM25+ A356#}	T5-Sand	26,000
AC601 {LM25+ A356#}	T6-Perm	27,000

Shear strength of standard parent materials, (indication only refer supplier for specific properties)

+Nearest British Equivalent

#Nearest US Equivalent

Assembly Design

Step Four, Determine the length of insert based on shear strength of parent material

Nominal Diameter 16.0 mm (selected bolt)
 Pitch 2.0 mm
 Pitch Diameter (min) 17.299mm
 (refer taped hole data)

Nominal Diameter 0.500" (selected bolt)
 TPI 13
 Pitch Diameter (min) 0.550"
 (refer taped hole data)

$$L = \frac{\text{Tensile Strength of Bolt}}{\text{Shear Circumference Strength of Hole} \times \text{Arbitrary Constant}}$$

$$L = \frac{\text{Tensile Strength of Bolt}}{\text{Shear Circumference Strength of Hole} \times \text{Arbitrary Constant}}$$

L = Required length of fitted insert

Arbitrary Constant = 0.5

(0.5 Based on shearing of the parent material occurring along the pitch diameter of the tapped hole)

L = Required length of fitted insert

Arbitrary Constant = 0.5

(0.5 Based on shearing of the parent material occurring along the pitch diameter of the tapped hole)

$$L = \frac{1034 \times (13.7972 \times \pi/4)}{283 \times 17.299 \times \pi \times 0.5}$$

L = 20.1mm

$$L = \frac{181,000 \times (0.4072 \times \pi/4)}{25,000 \times 0.550 \times \pi \times 0.5}$$

L = 1.09"

Conclusion:

For this application a 16mm diameter bolt has been selected. Insert engagement of 20.1mm was calculated. The suitable diameter of the insert can be determined by dividing the length of the insert by the diameter of the bolt.

For example:

L/dia = 20.1mm/16mm
 = 1.26 select next highest size
 Therefore use a 1.5D insert

Conclusion:

For this application a 1/2" diameter bolt has been selected. Insert engagement of 1.09" was calculated. The suitable diameter of the insert can be determined by dividing the length of the insert by the diameter of the bolt.

For example:

L/dia = 1.09"/0.5"
 = 2.2 select next highest size
 Therefore use a 2.5D insert

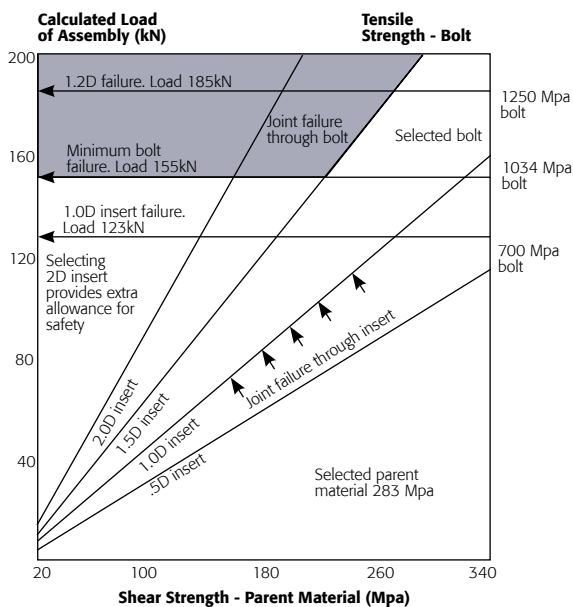

The shaded area in the graph indicates the region in which bolt failure will occur.

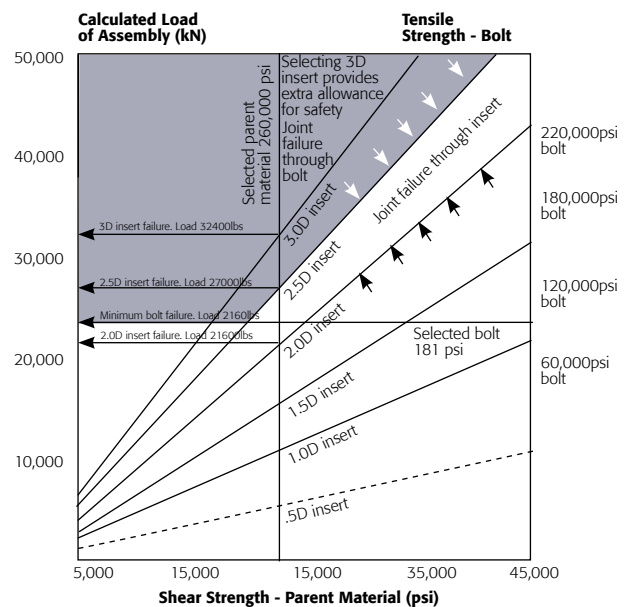

The shaded area in the graph indicates the region in which bolt failure will occur.

Note: Inserts are available in standard lengths which are multiples of the diameter. For example an insert with a length of 1.5D will measure one and a half times as long as the diameter when installed. Note: The example above is an indication only. Professional engineering advice must be sought when exact design calculations are required.

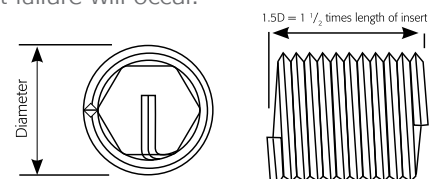

Thread Identification and Drill Chart

Metric

DIA IN INCHES	THREAD SIZE MM	ISO COARSE			ISO FINE			BA					
		DRILL SIZE	DRILL SIZE	DIAMETER INCH	DRILL SIZE	DIAMETER MM	OTHER	PITCH INCH	MM	SIZE	MM	IMCH	PITCH INCH
.079	2	.4		2.1					0	6.0	0.236	1	6.2
.087	2.2	.45	No. 42	2.3					2	4.7	0.185	0.8	4.9
.098	2.5	.45	No. 37	2.6					4	3.6	0.142	0.66	3.8
.118	3	.5	1/8	3.2					6	2.8	0.11	0.53	2.9
.138	3.5	0.6	No. 27	3.7					8	2.2	0.86	0.43	2.3
.157	4	.7	11/64	4.2					10	1.7	0.67	0.35	1.7
.197	5	.8	3/64	5.2									
.236	6	1	1/4	6.3									
.276	7	1	9/32	7.3									
.315	8	1.25	21/64	8.3			1	21/64	8.3				
.354	9	1.25		9.4			1		9.3				
.394	10	1.5	13/32	10.4	1*		1.25	13/32	10.25				
.433	11	1.5		11.5	1		1.25		11.25				
.472	12	1.75	31/64	12.5	1.25		1.5	31/64	12.25				
.512	13			13.5			1.5		13.25				
.551	14	2	37/64	14.5	1.25*		1.5	9/16	14.25				
.630	16	2	21/32	16.5			1.5	21/32	16.5				
.709	18	2.5	47/64	18.75	1.5*		2	23/32	18.5				
.787	20	2.5	13/16	20.75	1.5		2	3/16	20.5				
.866	22	2.5		22.75	1.5		2		22.5				
.945	24	3		24.75	1.5		2		24.5				

*M10 X 1, M12 X 1.25, M14 X 1.25, M18 X 1.5 - popular spark plug sizes sizes above M24 available on request.

INCH

DIAMETER INCHES	THREADS PER INCH				DRILL SIZE									
	MM SIZE	THREAD	UNC	BSW (SAE)	UNF	BSF	BSF*	NPT INCH	UNC MM	BSW INCH	UNF, SAE, BSF MM	BSF INCH	BSP MM	NPT
.86	2.18	#2	56	40	64				3/32	2.3	No. 37	2.3		
.990	2.51	#3	48		56				No.36	2.7		2.7		
.112	2.84	#4	40		48				No.31	3.0	No.31	3.0		
.125	3.17	#5 (1/8)	40		44		28	27	N0.29	3.4		3.3	3/8	9.9
.138	3.50	#6	32		40				N0.25	3.7	N0.26	3.7		
.164	4.16	#8	32		36				11/64	4.4	11/64	4.4		
.190	4.82	#10 (3/16)		24			32			13/64	5.1	13/64	5.1	
.187	4.76	3/16		24		32			13/64	5.0	13/64	5.0		
.216	5.49	#12 (7/32)		24	24					15/64	5.6			
.250	6.35	1/4	20	20	28	26	19	18	17/64	6.7	17/64	6.6	33/64	13.5
.312	7.93	5/16	18	18	24	22			21/64	8.3	21/64	8.2		
.375	9.52	3/8	16	16	24	20	19	18	25/64	9.9	25/64	9.8	21/32	17.0
.437	11.11	7/16	14	14	20	18			29/64	11.5	29/64	11.5		
.500	12.70	1/2	13	12	20	16	14	14	17/32	13.0	33/64	13.0	13/16	21.5
.562	14.28	9/16	12	12	18	16			19/32	14.5	37/64	14.5		
.625	15.87	5/8	11	11	18	14			21/32	16.5	41/64	16.25		
.750	19.05	3/4	10	10	16	12	14	14	25/32	19.75	49/64	19.5	1 1/64	27.0
.875	22.22	7/8	9	9	14	11			29/32	23.0	57/64	22.5		
1.000	25.40	1"	8	8	12 (14)	10	11	11 1/2	1 1/32	26.0	1 1/64	26.0	1 9/32	33.5
1.125	28.57	1 1/8"	7	7	12	9	11		1 5/32	29.5	1 5/32	29.5		
1.250	31.75	1 1/4"	7	7	12	9	11		1 9/32	33.0	1 9/32	32.5		
1.375	34.92	1 3/8"	6	6	12	8	11		1 13/32	36.0	1 13/32	36.0		
1.500	38.10	1 1/2"	6	6	12	8	11		1 17/32	39.0	1 17/32	39.0		

*Nominal diameters for BSP and NPT are not thread diameters but relate to the inside diameter of the pipe.

General Information

SI Units & Conversions for Characteristics of Mechanical Fasteners

PROPERTY	UNIT	SYMBOL	CONVERSION		MULTIPLY BY	APPROXIMATE / EQUIV
			FROM	TO		
Length	metre	m	inch	mm	25.4	25mm = 1 in
	centimeter	cm	inch	cm	2.54	300mm=1 ft
Mass	millimeter	mm	foot	mm	304.8	1m = 39.37
	kilogram	kg	ounce	g	28.35	28g = 1oz
	gram	g	pound	kg	.4536	1kg = 2.2lb = 35oz
Density	tonne (megagram)	t	ton (224lb)	kg	984.2	1t = 2206lbs
	kilogram per deg. Celsius	kg/m ³	pounds per cu. ft	kg/m ³	16.02	16kg/m ³ = 1lb/ft ³
Temperature		°C	deg. Fahr	°C	(°F-32)x5/9	0°C = 32 °F
Area	square metre	m ²	sq. inch	mm ²	645.2	645mm ² = 1 in ²
	squaremillimetre	mm ²	sq. ft	m ²	.0929	1m ² = 11 ft ²
Volume	cub. metre	m ³	cu. in	mm ³	16387	16400mm ³ = 1 in ³
	cubic centimeter	cm ³	cu. Ft	m ³	.02832	1m ³ = 35ft ³
	cubic millimeter	mm ³	cu. Yd	m ³	.7645	1m ³ = 1.3yd
Force	newton	N	ounce(Force)	N	.278	1N = 3.6 ozf
	kilonewton	kN	pound(Force)	kN	.00445	4.4N = 1 lbf
	meganewton	MN	kip	MN	.00445	1kN = 225 lbf
Pressure	bar	MPa	bar	.1	1MPa = 1bar	
	megapascal	MPa	pound/in ² (psi)	MPa	.0069	1MPa = 145 psi
	newton/sqmm	N/m ²	Kip/in ² (ksi)	MPa	6.895	7MPa = 1ksi
Torque	newton-meters	N-m	inch-ounce	N-m	.00706	1N-m = 140 in.oz
			inch-pound	N-m	.113	1N-m = 9 in. lb
			foot-pound	N-m	1.356	1N-m.75 ft lb 1.4N-m = 1 ft.lb

Hardness Comparison Table

Brinell 10m/m Ball 3000kg load.	Firth or Vickers 120kg	Rockwell		Brinell 10m/m Ball 3000kg load.	Firth or Vickers 120kg	Rockwell	
		C. Scale 1200 Cone 150kg load.	B. Scale 1/16" Ball 100kg load			C. Scale 1200 Cone 150kg load.	B. Scale 1/16" 100kg load.
800	-	72	-	276	278	30	105
780	1220	71	-	269	272	29	104
760	1170	70	-	261	261	28	103
745	1114	68	-	258	258	27	102
725	1060	67	-	255	255	26	102
712	1021	66	-	249	250	25	101
682	940	65	-	245	246	24	100
688	905	64	-	240	240	23	99
652	867	63	-	237	235	22	99
262	803	62	-	229	226	21	98
614	775	61	-	224	221	20	97
601	746	60	-	217	127	19	96
590	727	59	-	211	213	18	95
576	694	57	-	206	209	17	94
552	649	56	-	203	201	16	94
545	639	55	-	200	199	15	93
529	606	54	-	196	197	14	92
514	587	53	120	191	190	13	92
502	565	52	119	187	186	12	91
495	551	51	119	185	184	11	91
477	534	49	118	183	183	10	90
461	489	47	117	175	174	7	88
444	474	46	116	170	171	6	87
427	460	45	115	167	168	5	87
415	435	44	115	165	165	4	86
401	413	43	114	163	162	3	85
388	401	42	114	160	159	2	84
374	390	41	113	156	154	1	83
370	385	40	112	154	152	-	-82
362	280	39	111	152	150	-	-82
351	361	38	111	147	147	-	-80
346	352	37	110	147	147	-	-79
331	335	36	109	143	144	-	-79
323	320	35	109	141	142	-	-77
311	312	34	108	140	135	-	-75
301	305	33	107	135	135	-	-75
293	291	32	106	130	130	-	-72
285	285	31	105	-	-	-	-

Recoil.® Bringing versatility to a range of applications.

The range of wire thread inserts by Recoil are designed to enable you to produce strong threads in softer materials or more evenly distributed thread loads in harder materials. Thread strengthening needs to be fast, reliable and cost effective - decades of engineering experience means Recoil products carry a global reputation for delivering these OEM essentials.

With a choice of free-running or screw-locking designs, Recoil® offers a broad range of thread insert systems to ensure the best match of product to the application. The standard Recoil free-running insert provides for easy

installation of a female thread, delivering the necessary "holding power" for most applications. For particularly demanding or extreme high-vibration applications, Recoil offers a screw-locking design, which provides a superior locking function in the female thread.

Alcoa Fastening Systems' (AFS) Recoil manufacturing operations are located in Australia, with sales and warehouse facilities strategically placed in North America, Asia and Europe. The European distribution centre is based in Telford, UK.

Contact

Recoil Regional Distribution Centres Australia

Clayton Business Park
1508 Centre Rd Clayton Vic 3168 Australia
PO Box 144 Mount Waverley 3149 Australia
Tel: Sales Australia 1300 363 049
International +613 8545 3333
Fax: Sales Australia 1300 363 154
International +613 8545 3390
Email: afs.sales@alcoa.com.au
Web www.recoil.com.au

Singapore

Block 5, Ang Mo Kio Industrial Park 2A
#04-15 AMK Tech 2
Singapore 567760
Singapore
Telephone (65) 6759 1978
Fax (65) 6759 1582

Shanghai Sales

Area A2, 1st Floor
No. 205 Taigu Road
Waigaocqiao Free Trade Zone
Shanghai, 200131, China
Tel: +86 21 5866 5080
Fax: +86 21 5868 1859

AFS Industrial Distribution Group Headquarters

1925 North MacArthur Drive
Tracy, CA 95376, USA
Tel: 209 839 3000
Fax: 209 839 3022

AFS Industrial Distribution

14300 Clay Terrace Blvd, Suite 250
Carmel, IN 46032, USA
Tel: 800 826 2884
Fax: 800 573 2645

Telford Operations

Unit C, Stafford Park 7
Telford, Shropshire TF3, 3BQ
United Kingdom
Tel: +44 1952 2900 11
Fax: +44 1952 2904 59

China

58 Yinsheng Road, Shengpu
Suzhou industrial Park
Suzhou Jiangsu 215126, China
Tel: 86 010 5921 5077
Fax: 86 010 5921 5100

India Operations

Level 6, Constantia 11
U.N. Brahachari Street
Kolkata 700,017 WB India
Tel: +91 33 4400 0612
Fax: +91 33 4400 0555

Japan/Korea Sales

Alcoa Japan Ltd.
#1013 NBF Hibiya Bldg.
Uchisaiwai-cho, Chiyoda-ku
Tokyo 100-1011
Phone: +81 3 3539 6577
Fax: +81 3 3539 6585

Europe

Alcoa Fastening Systems
St Cosme Operations
9 rue de Cressonnières
72110 Saint Cosme en Varais, France
Tel: +33 0 2.43.31.41.00
Fax: +33 0 2.43.31.41.41

Alcoa Fastening Systems

Kelkheim Operations
Industriestr. 6
65779 Kelkheim, Germany
Tel: +49 0 6195 8050
Fax: +49 0 6195 2001

Americas

Industrial Fastener Division
8001 Imperial Drive
Waco, TX 76712, USA
P.O. Box 8117
Waco, TX 76714-8117, USA
Tel: 800 388 4825
Fax: 800 798 4825

Installation Tool Division

1 Corporate Drive
Kingston, NY 12401, USA
Tel: 800 278 4825
Fax: 845 334 7333

Latin America Sales

Avenida Parque Lira
79-402 Tacubaya
Mexico C P 11850, USA
Tel: +52 55 5515 1776
Fax: +52 55 5277 7564

Your Authorised Distributor

Disclaimer:
The information contained in this publication is only for general guidance with regard to properties of the products shown and/or the means for selecting such products, and is not intended to create any warranty, express, implied, or statutory; all warranties are contained only in AFS's written quotations, acknowledgments, and/or purchase orders. It is recommended that the user secure specific, up-to-date data and information regarding each application and/or use of such products.

©2012 Alcoa Fastening Systems Ltd. All rights reserved.

**Alcoa
Fastening
Systems**

