

## EasyPACK™ module with TRENCHSTOP™ IGBT H3 and emitter controlled 7 diode and PressFIT / NTC

### Features

- Electrical features
  - $V_{CES} = 1200\text{ V}$
  - $I_{C\text{nom}} = 225\text{ A} / I_{CRM} = 450\text{ A}$
  - Low switching losses
  - High-speed IGBT H3
- Mechanical features
  - Compact design
  - PressFIT contact technology
  - Integrated NTC temperature sensor
  - High power density

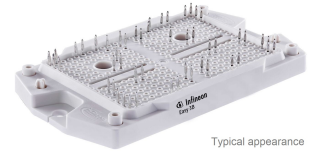

Typical appearance

### Potential applications

- Energy storage systems
- Solar applications
- Three-level applications

### Product validation

- Qualified for industrial applications according to the relevant tests of IEC 60747, 60749 and 60068

### Description

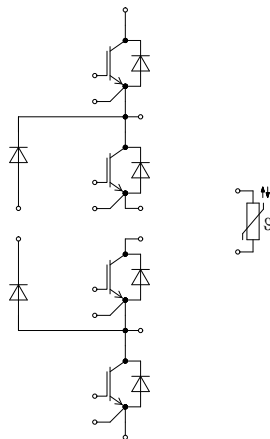

## Table of contents

	<b>Description</b> .....	1
	<b>Features</b> .....	1
	<b>Potential applications</b> .....	1
	<b>Product validation</b> .....	1
	<b>Table of contents</b> .....	2
<b>1</b>	<b>Package</b> .....	3
<b>2</b>	<b>IGBT, T1 / T4</b> .....	3
<b>3</b>	<b>IGBT, T2 / T3</b> .....	5
<b>4</b>	<b>Diode, D1 / D4</b> .....	6
<b>5</b>	<b>Diode, D2 / D3</b> .....	7
<b>6</b>	<b>Diode, D5 / D6</b> .....	8
<b>7</b>	<b>NTC-Thermistor</b> .....	9
<b>8</b>	<b>Characteristics diagrams</b> .....	10
<b>9</b>	<b>Circuit diagram</b> .....	18
<b>10</b>	<b>Package outlines</b> .....	19
<b>11</b>	<b>Module label code</b> .....	19
	<b>Revision history</b> .....	20
	<b>Disclaimer</b> .....	21

## 1 Package

**Table 1 Insulation coordination**

Parameter	Symbol	Note or test condition	Values	Unit
Isolation test voltage	$V_{ISOL}$	RMS, $f = 50 \text{ Hz}$ , $t = 1 \text{ min}$	3.2	kV
Internal isolation		basic insulation (class 1, IEC 61140)	$\text{Al}_2\text{O}_3$	
Comparative tracking index	$CTI$		> 400	
Relative thermal index (electrical)	$RTI$	housing	140	°C

**Table 2 Characteristic values**

Parameter	Symbol	Note or test condition	Values			Unit
			Min.	Typ.	Max.	
Stray inductance module	$L_{sCE}$			21		nH
Module lead resistance, terminals - chip	$R_{AA'+CC'}$	$T_H = 25 \text{ °C}$ , per switch		2.3		mΩ
Module lead resistance, terminals - chip	$R_{CC'+EE'}$	$T_H = 25 \text{ °C}$ , per switch		1.7		mΩ
Storage temperature	$T_{stg}$		-40		125	°C
Mounting torque for module mounting	$M$	- Mounting according to valid application note	M5, Screw	1.3	1.5	Nm
Weight	$G$			78		g

Note: The current under continuous operation is limited to 25A rms per connector pin.

## 2 IGBT, T1 / T4

**Table 3 Maximum rated values**

Parameter	Symbol	Note or test condition	Values	Unit
Collector-emitter voltage	$V_{CES}$	$T_{vj} = 25 \text{ °C}$	1200	V
Implemented collector current	$I_{CN}$		225	A
Continuous DC collector current	$I_{CDC}$	$T_{vj \text{ max}} = 175 \text{ °C}$ $T_H = 65 \text{ °C}$	175	A
Repetitive peak collector current	$I_{CRM}$	$t_p$ limited by $T_{vj \text{ op}}$	450	A
Gate-emitter peak voltage	$V_{GES}$		±20	V

**Table 4 Characteristic values**

Parameter	Symbol	Note or test condition	Values			Unit	
			Min.	Typ.	Max.		
Collector-emitter saturation voltage	$V_{CE\ sat}$	$I_C = 225\ A, V_{GE} = 15\ V$	$T_{vj} = 25\ ^\circ C$		2.07	2.55	V
			$T_{vj} = 125\ ^\circ C$		2.50		
			$T_{vj} = 150\ ^\circ C$		2.60		
Gate threshold voltage	$V_{GETh}$	$I_C = 7.8\ mA, V_{CE} = V_{GE}, T_{vj} = 25\ ^\circ C$		5.25	5.80	6.35	V
Gate charge	$Q_G$	$V_{GE} = \pm 15\ V$			1.73		$\mu C$
Internal gate resistor	$R_{Gint}$	$T_{vj} = 25\ ^\circ C$			3.3		$\Omega$
Input capacitance	$C_{ies}$	$f = 100\ kHz, T_{vj} = 25\ ^\circ C, V_{CE} = 25\ V, V_{GE} = 0\ V$			13.1		nF
Reverse transfer capacitance	$C_{res}$	$f = 100\ kHz, T_{vj} = 25\ ^\circ C, V_{CE} = 25\ V, V_{GE} = 0\ V$			0.72		nF
Collector-emitter cut-off current	$I_{CES}$	$V_{CE} = 1200\ V, V_{GE} = 0\ V$	$T_{vj} = 25\ ^\circ C$			1	mA
Gate-emitter leakage current	$I_{GES}$	$V_{CE} = 0\ V, V_{GE} = 20\ V, T_{vj} = 25\ ^\circ C$				100	nA
Turn-on delay time (inductive load)	$t_{don}$	$I_C = 225\ A, V_{CC} = 600\ V, V_{GE} = \pm 15\ V, R_{Gon} = 0.47\ \Omega$	$T_{vj} = 25\ ^\circ C$		0.107		$\mu s$
			$T_{vj} = 125\ ^\circ C$		0.115		
			$T_{vj} = 150\ ^\circ C$		0.118		
Rise time (inductive load)	$t_r$	$I_C = 225\ A, V_{CC} = 600\ V, V_{GE} = \pm 15\ V, R_{Gon} = 0.47\ \Omega$	$T_{vj} = 25\ ^\circ C$		0.030		$\mu s$
			$T_{vj} = 125\ ^\circ C$		0.035		
			$T_{vj} = 150\ ^\circ C$		0.037		
Turn-off delay time (inductive load)	$t_{doff}$	$I_C = 225\ A, V_{CC} = 600\ V, V_{GE} = \pm 15\ V, R_{Goff} = 0.47\ \Omega$	$T_{vj} = 25\ ^\circ C$		0.300		$\mu s$
			$T_{vj} = 125\ ^\circ C$		0.329		
			$T_{vj} = 150\ ^\circ C$		0.346		
Fall time (inductive load)	$t_f$	$I_C = 225\ A, V_{CC} = 600\ V, V_{GE} = \pm 15\ V, R_{Goff} = 0.47\ \Omega$	$T_{vj} = 25\ ^\circ C$		0.040		$\mu s$
			$T_{vj} = 125\ ^\circ C$		0.129		
			$T_{vj} = 150\ ^\circ C$		0.148		
Turn-on energy loss per pulse	$E_{on}$	$I_C = 225\ A, V_{CC} = 600\ V, L_\sigma = 35\ nH, V_{GE} = \pm 15\ V, R_{Gon} = 0.47\ \Omega, di/dt = 6100\ A/\mu s (T_{vj} = 150\ ^\circ C)$	$T_{vj} = 25\ ^\circ C$		11.8		mJ
			$T_{vj} = 125\ ^\circ C$		20.7		
			$T_{vj} = 150\ ^\circ C$		23.4		
Turn-off energy loss per pulse	$E_{off}$	$I_C = 225\ A, V_{CC} = 600\ V, L_\sigma = 35\ nH, V_{GE} = \pm 15\ V, R_{Goff} = 0.47\ \Omega, dv/dt = 4500\ V/\mu s (T_{vj} = 150\ ^\circ C)$	$T_{vj} = 25\ ^\circ C$		8.67		mJ
			$T_{vj} = 125\ ^\circ C$		15.9		
			$T_{vj} = 150\ ^\circ C$		17.8		
SC data	$I_{SC}$	$V_{GE} \leq 15\ V, V_{CC} = 800\ V, V_{CEmax} = V_{CES} - L_{sCE} * di/dt$	$t_p \leq 10\ \mu s, T_{vj} = 150\ ^\circ C$		900		A

(table continues...)

**Table 4 (continued) Characteristic values**

Parameter	Symbol	Note or test condition	Values			Unit
			Min.	Typ.	Max.	
Thermal resistance, junction to heat sink	$R_{thJH}$	per IGBT, $\lambda_{grease} = 3.3 \text{ W}/(\text{m}\cdot\text{K})$		0.218		K/W
Temperature under switching conditions	$T_{vj\text{op}}$		-40		150	°C

### 3 IGBT, T2 / T3

**Table 5 Maximum rated values**

Parameter	Symbol	Note or test condition	Values	Unit
Collector-emitter voltage	$V_{CES}$	$T_{vj} = 25 \text{ °C}$	1200	V
Implemented collector current	$I_{CN}$		225	A
Continuous DC collector current	$I_{CDC}$	$T_{vj\text{max}} = 175 \text{ °C}$ $T_H = 65 \text{ °C}$	180	A
Repetitive peak collector current	$I_{CRM}$	$t_p$ limited by $T_{vj\text{op}}$	450	A
Gate-emitter peak voltage	$V_{GES}$		±20	V

**Table 6 Characteristic values**

Parameter	Symbol	Note or test condition	Values			Unit
			Min.	Typ.	Max.	
Collector-emitter saturation voltage	$V_{CE\text{sat}}$	$I_C = 225 \text{ A}, V_{GE} = 15 \text{ V}$	$T_{vj} = 25 \text{ °C}$	2.07	2.55	V
			$T_{vj} = 125 \text{ °C}$	2.50		
			$T_{vj} = 150 \text{ °C}$	2.60		
Gate threshold voltage	$V_{GEth}$	$I_C = 7.8 \text{ mA}, V_{CE} = V_{GE}, T_{vj} = 25 \text{ °C}$	5.25	5.80	6.35	V
Gate charge	$Q_G$	$V_{GE} = \pm 15 \text{ V}$		1.73		μC
Internal gate resistor	$R_{Gint}$	$T_{vj} = 25 \text{ °C}$		3.3		Ω
Input capacitance	$C_{ies}$	$f = 100 \text{ kHz}, T_{vj} = 25 \text{ °C}, V_{CE} = 25 \text{ V}, V_{GE} = 0 \text{ V}$		13.1		nF
Reverse transfer capacitance	$C_{res}$	$f = 100 \text{ kHz}, T_{vj} = 25 \text{ °C}, V_{CE} = 25 \text{ V}, V_{GE} = 0 \text{ V}$		0.72		nF
Collector-emitter cut-off current	$I_{CES}$	$V_{CE} = 1200 \text{ V}, V_{GE} = 0 \text{ V}$ $T_{vj} = 25 \text{ °C}$			1	mA
Gate-emitter leakage current	$I_{GES}$	$V_{CE} = 0 \text{ V}, V_{GE} = 20 \text{ V}, T_{vj} = 25 \text{ °C}$			100	nA

**(table continues...)**

**Table 6** (continued) **Characteristic values**

Parameter	Symbol	Note or test condition	Values			Unit
			Min.	Typ.	Max.	
Turn-on delay time (inductive load)	$t_{don}$	$I_C = 225\text{ A}, V_{CC} = 600\text{ V}, V_{GE} = \pm 15\text{ V}, R_{Gon} = 0.47\ \Omega$	$T_{vj} = 25\text{ }^\circ\text{C}$	0.107		$\mu\text{s}$
			$T_{vj} = 125\text{ }^\circ\text{C}$	0.117		
			$T_{vj} = 150\text{ }^\circ\text{C}$	0.122		
Rise time (inductive load)	$t_r$	$I_C = 225\text{ A}, V_{CC} = 600\text{ V}, V_{GE} = \pm 15\text{ V}, R_{Gon} = 0.47\ \Omega$	$T_{vj} = 25\text{ }^\circ\text{C}$	0.039		$\mu\text{s}$
			$T_{vj} = 125\text{ }^\circ\text{C}$	0.048		
			$T_{vj} = 150\text{ }^\circ\text{C}$	0.050		
Turn-off delay time (inductive load)	$t_{doff}$	$I_C = 225\text{ A}, V_{CC} = 600\text{ V}, V_{GE} = \pm 15\text{ V}, R_{Goff} = 0.47\ \Omega$	$T_{vj} = 25\text{ }^\circ\text{C}$	0.290		$\mu\text{s}$
			$T_{vj} = 125\text{ }^\circ\text{C}$	0.340		
			$T_{vj} = 150\text{ }^\circ\text{C}$	0.360		
Fall time (inductive load)	$t_f$	$I_C = 225\text{ A}, V_{CC} = 600\text{ V}, V_{GE} = \pm 15\text{ V}, R_{Goff} = 0.47\ \Omega$	$T_{vj} = 25\text{ }^\circ\text{C}$	0.041		$\mu\text{s}$
			$T_{vj} = 125\text{ }^\circ\text{C}$	0.114		
			$T_{vj} = 150\text{ }^\circ\text{C}$	0.139		
Turn-on energy loss per pulse	$E_{on}$	$I_C = 225\text{ A}, V_{CC} = 600\text{ V}, L_\sigma = 35\text{ nH}, V_{GE} = \pm 15\text{ V}, R_{Gon} = 0.47\ \Omega, di/dt = 4600\text{ A}/\mu\text{s} (T_{vj} = 150\text{ }^\circ\text{C})$	$T_{vj} = 25\text{ }^\circ\text{C}$	8.1		mJ
			$T_{vj} = 125\text{ }^\circ\text{C}$	14.3		
			$T_{vj} = 150\text{ }^\circ\text{C}$	16.4		
Turn-off energy loss per pulse	$E_{off}$	$I_C = 225\text{ A}, V_{CC} = 600\text{ V}, L_\sigma = 35\text{ nH}, V_{GE} = \pm 15\text{ V}, R_{Goff} = 0.47\ \Omega, dv/dt = 4200\text{ V}/\mu\text{s} (T_{vj} = 150\text{ }^\circ\text{C})$	$T_{vj} = 25\text{ }^\circ\text{C}$	9.25		mJ
			$T_{vj} = 125\text{ }^\circ\text{C}$	17.5		
			$T_{vj} = 150\text{ }^\circ\text{C}$	19.6		
SC data	$I_{SC}$	$V_{GE} \leq 15\text{ V}, V_{CC} = 800\text{ V}, V_{CEmax} = V_{CES} - L_{SCE} * di/dt$	$t_p \leq 10\ \mu\text{s}, T_{vj} = 150\text{ }^\circ\text{C}$	900		A
Thermal resistance, junction to heat sink	$R_{thJH}$	per IGBT, $\lambda_{grease} = 3.3\text{ W}/(\text{m}\cdot\text{K})$		0.212		K/W
Temperature under switching conditions	$T_{vj\ op}$			-40	150	$^\circ\text{C}$

## 4 Diode, D1 / D4

**Table 7** **Maximum rated values**

Parameter	Symbol	Note or test condition	Values	Unit
Repetitive peak reverse voltage	$V_{RRM}$	$T_{vj} = 25\text{ }^\circ\text{C}$	1200	V
Continuous DC forward current	$I_F$		300	A
Repetitive peak forward current	$I_{FRM}$	$t_p = 1\text{ ms}$	600	A

(table continues...)

**Table 7 (continued) Maximum rated values**

Parameter	Symbol	Note or test condition	Values	Unit	
$I^2t$ - value	$I^2t$	$t_p = 10 \text{ ms}, V_R = 0 \text{ V}$	$T_{vj} = 125 \text{ °C}$	10900	$A^2s$
			$T_{vj} = 150 \text{ °C}$	6280	

**Table 8 Characteristic values**

Parameter	Symbol	Note or test condition	Values			Unit	
			Min.	Typ.	Max.		
Forward voltage	$V_F$	$I_F = 300 \text{ A}, V_{GE} = 0 \text{ V}$	$T_{vj} = 25 \text{ °C}$		1.72	2.10	V
			$T_{vj} = 125 \text{ °C}$		1.59		
			$T_{vj} = 150 \text{ °C}$		1.56		
Peak reverse recovery current	$I_{RM}$	$V_{CC} = 600 \text{ V}, I_F = 300 \text{ A}, V_{GE} = -15 \text{ V}, -di_F/dt = 4800 \text{ A}/\mu\text{s} (T_{vj} = 150 \text{ °C})$	$T_{vj} = 25 \text{ °C}$		229		A
			$T_{vj} = 125 \text{ °C}$		263		
			$T_{vj} = 150 \text{ °C}$		272		
Recovered charge	$Q_r$	$V_{CC} = 600 \text{ V}, I_F = 300 \text{ A}, V_{GE} = -15 \text{ V}, -di_F/dt = 4800 \text{ A}/\mu\text{s} (T_{vj} = 150 \text{ °C})$	$T_{vj} = 25 \text{ °C}$		20.5		$\mu\text{C}$
			$T_{vj} = 125 \text{ °C}$		38.4		
			$T_{vj} = 150 \text{ °C}$		44.5		
Reverse recovery energy	$E_{rec}$	$V_{CC} = 600 \text{ V}, I_F = 300 \text{ A}, V_{GE} = -15 \text{ V}, -di_F/dt = 4800 \text{ A}/\mu\text{s} (T_{vj} = 150 \text{ °C})$	$T_{vj} = 25 \text{ °C}$		7.88		mJ
			$T_{vj} = 125 \text{ °C}$		14.2		
			$T_{vj} = 150 \text{ °C}$		16.2		
Thermal resistance, junction to heat sink	$R_{thJH}$	per diode, $\lambda_{grease} = 3.3 \text{ W}/(\text{m}\cdot\text{K})$		0.354		K/W	
Temperature under switching conditions	$T_{vjop}$		-40		150	$^{\circ}\text{C}$	

## 5 Diode, D2 / D3

**Table 9 Maximum rated values**

Parameter	Symbol	Note or test condition	Values	Unit	
Repetitive peak reverse voltage	$V_{RRM}$		$T_{vj} = 25 \text{ °C}$	1200	V
Continuous DC forward current	$I_F$			200	A
Repetitive peak forward current	$I_{FRM}$	$t_p = 1 \text{ ms}$		400	A
$I^2t$ - value	$I^2t$	$t_p = 10 \text{ ms}, V_R = 0 \text{ V}$	$T_{vj} = 125 \text{ °C}$	3320	$A^2s$
			$T_{vj} = 150 \text{ °C}$	2110	

**Table 10** Characteristic values

Parameter	Symbol	Note or test condition	Values			Unit	
			Min.	Typ.	Max.		
Forward voltage	$V_F$	$I_F = 200 \text{ A}, V_{GE} = 0 \text{ V}$	$T_{vj} = 25 \text{ °C}$		1.72	2.10	V
			$T_{vj} = 125 \text{ °C}$		1.59		
			$T_{vj} = 150 \text{ °C}$		1.56		
Peak reverse recovery current	$I_{RM}$	$V_{CC} = 600 \text{ V}, I_F = 200 \text{ A}, V_{GE} = -15 \text{ V}, -di_F/dt = 4300 \text{ A}/\mu\text{s} (T_{vj} = 150 \text{ °C})$	$T_{vj} = 25 \text{ °C}$		195		A
			$T_{vj} = 125 \text{ °C}$		238		
			$T_{vj} = 150 \text{ °C}$		248		
Recovered charge	$Q_r$	$V_{CC} = 600 \text{ V}, I_F = 200 \text{ A}, V_{GE} = -15 \text{ V}, -di_F/dt = 4300 \text{ A}/\mu\text{s} (T_{vj} = 150 \text{ °C})$	$T_{vj} = 25 \text{ °C}$		14.1		$\mu\text{C}$
			$T_{vj} = 125 \text{ °C}$		27.4		
			$T_{vj} = 150 \text{ °C}$		31.3		
Reverse recovery energy	$E_{rec}$	$V_{CC} = 600 \text{ V}, I_F = 200 \text{ A}, V_{GE} = -15 \text{ V}, -di_F/dt = 4300 \text{ A}/\mu\text{s} (T_{vj} = 150 \text{ °C})$	$T_{vj} = 25 \text{ °C}$		5.72		mJ
			$T_{vj} = 125 \text{ °C}$		11.1		
			$T_{vj} = 150 \text{ °C}$		12.5		
Thermal resistance, junction to heat sink	$R_{thJH}$	per diode, $\lambda_{grease} = 3.3 \text{ W}/(\text{m}\cdot\text{K})$			0.415		K/W
Temperature under switching conditions	$T_{vj\ op}$			-40		150	$^{\circ}\text{C}$

## 6 Diode, D5 / D6

**Table 11** Maximum rated values

Parameter	Symbol	Note or test condition	Values	Unit	
Repetitive peak reverse voltage	$V_{RRM}$	$T_{vj} = 25 \text{ °C}$	1200	V	
Continuous DC forward current	$I_F$		300	A	
Repetitive peak forward current	$I_{FRM}$	$t_p = 1 \text{ ms}$	600	A	
$I^2t$ - value	$I^2t$	$t_p = 10 \text{ ms}, V_R = 0 \text{ V}$	$T_{vj} = 125 \text{ °C}$	10900	$\text{A}^2\text{s}$
			$T_{vj} = 150 \text{ °C}$	6280	



**Table 12** Characteristic values

Parameter	Symbol	Note or test condition	Values			Unit	
			Min.	Typ.	Max.		
Forward voltage	$V_F$	$I_F = 300 \text{ A}, V_{GE} = 0 \text{ V}$	$T_{vj} = 25 \text{ }^\circ\text{C}$		1.72	2.10	V
			$T_{vj} = 125 \text{ }^\circ\text{C}$		1.59		
			$T_{vj} = 150 \text{ }^\circ\text{C}$		1.56		
Peak reverse recovery current	$I_{RM}$	$V_{CC} = 600 \text{ V}, I_F = 300 \text{ A}, V_{GE} = -15 \text{ V}, -di_F/dt = 6200 \text{ A}/\mu\text{s} (T_{vj} = 150 \text{ }^\circ\text{C})$	$T_{vj} = 25 \text{ }^\circ\text{C}$		244		A
			$T_{vj} = 125 \text{ }^\circ\text{C}$		263		
			$T_{vj} = 150 \text{ }^\circ\text{C}$		272		
Recovered charge	$Q_r$	$V_{CC} = 600 \text{ V}, I_F = 300 \text{ A}, V_{GE} = -15 \text{ V}, -di_F/dt = 6200 \text{ A}/\mu\text{s} (T_{vj} = 150 \text{ }^\circ\text{C})$	$T_{vj} = 25 \text{ }^\circ\text{C}$		20.4		$\mu\text{C}$
			$T_{vj} = 125 \text{ }^\circ\text{C}$		38.4		
			$T_{vj} = 150 \text{ }^\circ\text{C}$		44.5		
Reverse recovery energy	$E_{rec}$	$V_{CC} = 600 \text{ V}, I_F = 300 \text{ A}, V_{GE} = -15 \text{ V}, -di_F/dt = 6200 \text{ A}/\mu\text{s} (T_{vj} = 150 \text{ }^\circ\text{C})$	$T_{vj} = 25 \text{ }^\circ\text{C}$		6.87		mJ
			$T_{vj} = 125 \text{ }^\circ\text{C}$		13		
			$T_{vj} = 150 \text{ }^\circ\text{C}$		14.8		
Thermal resistance, junction to heat sink	$R_{thJH}$	per diode, $\lambda_{grease} = 3.3 \text{ W}/(\text{m}\cdot\text{K})$		0.399		K/W	
Temperature under switching conditions	$T_{vj\text{ op}}$		-40		150	$^\circ\text{C}$	

## 7 NTC-Thermistor

**Table 13** Characteristic values

Parameter	Symbol	Note or test condition	Values			Unit
			Min.	Typ.	Max.	
Rated resistance	$R_{25}$	$T_{NTC} = 25 \text{ }^\circ\text{C}$		5		k $\Omega$
Deviation of $R_{100}$	$\Delta R/R$	$T_{NTC} = 100 \text{ }^\circ\text{C}, R_{100} = 493 \text{ } \Omega$	-5		5	%
Power dissipation	$P_{25}$	$T_{NTC} = 25 \text{ }^\circ\text{C}$			20	mW
B-value	$B_{25/50}$	$R_2 = R_{25} \exp[B_{25/50}(1/T_2 - 1/(298,15 \text{ K}))]$		3375		K
B-value	$B_{25/80}$	$R_2 = R_{25} \exp[B_{25/80}(1/T_2 - 1/(298,15 \text{ K}))]$		3411		K
B-value	$B_{25/100}$	$R_2 = R_{25} \exp[B_{25/100}(1/T_2 - 1/(298,15 \text{ K}))]$		3433		K

Note: Specification according to the valid application note.

## 8 Characteristics diagrams

**Output characteristic (typical), IGBT, T1 / T4**

$$I_C = f(V_{CE})$$

$$V_{GE} = 15 \text{ V}$$

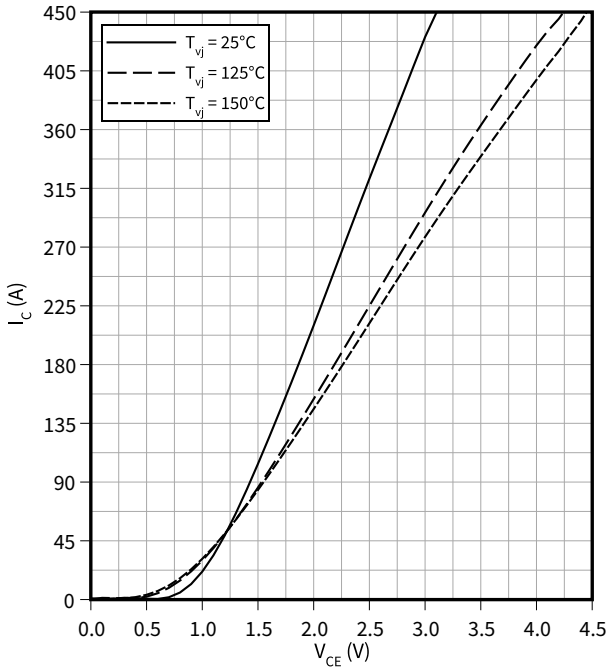

**Output characteristic field (typical), IGBT, T1 / T4**

$$I_C = f(V_{CE})$$

$$T_{vj} = 150 \text{ °C}$$

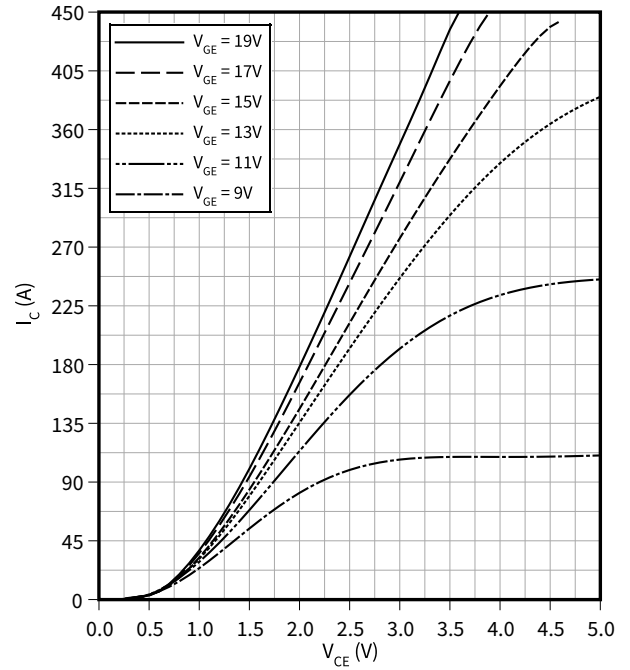

**Transfer characteristic (typical), IGBT, T1 / T4**

$$I_C = f(V_{GE})$$

$$V_{CE} = 20 \text{ V}$$

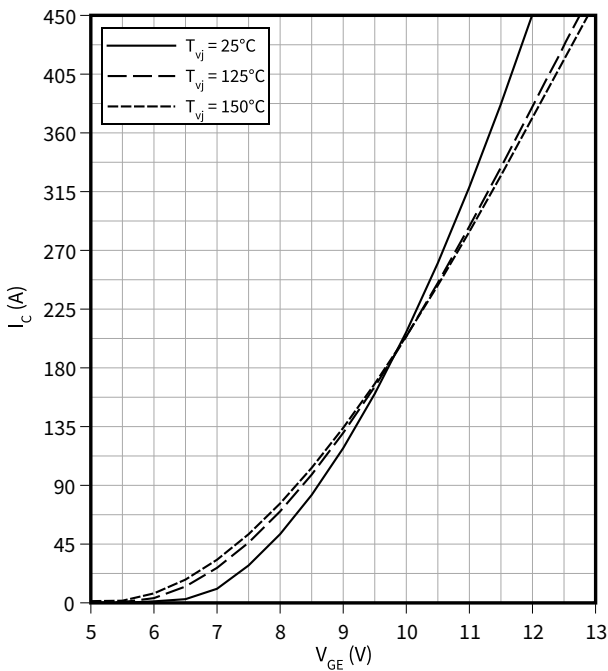

**Switching losses (typical), IGBT, T1 / T4**

$$E = f(I_C)$$

$$R_{Goff} = 0.47 \text{ } \Omega, R_{Gon} = 0.47 \text{ } \Omega, V_{GE} = \pm 15 \text{ V}, V_{CC} = 600 \text{ V}$$

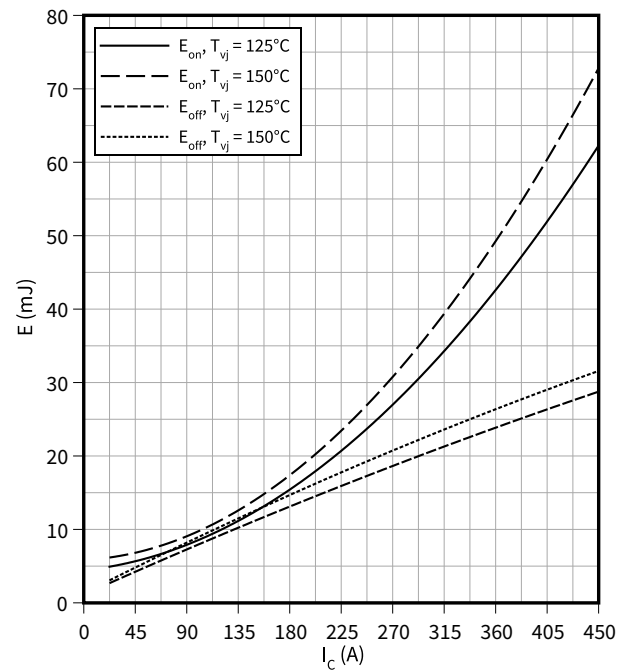

**Switching losses (typical), IGBT, T1 / T4**

$E = f(R_G)$

$V_{GE} = \pm 15 \text{ V}$ ,  $I_C = 225 \text{ A}$ ,  $V_{CC} = 600 \text{ V}$

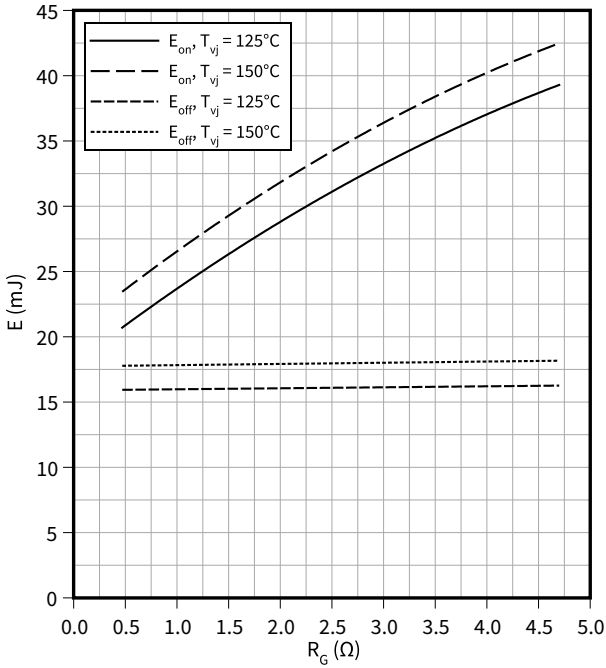

**Switching times (typical), IGBT, T1 / T4**

$t = f(I_C)$

$R_{Goff} = 0.47 \Omega$ ,  $R_{Gon} = 0.47 \Omega$ ,  $V_{GE} = \pm 15 \text{ V}$ ,  $V_{CC} = 600 \text{ V}$ ,  $T_{vj} = 150 \text{ °C}$

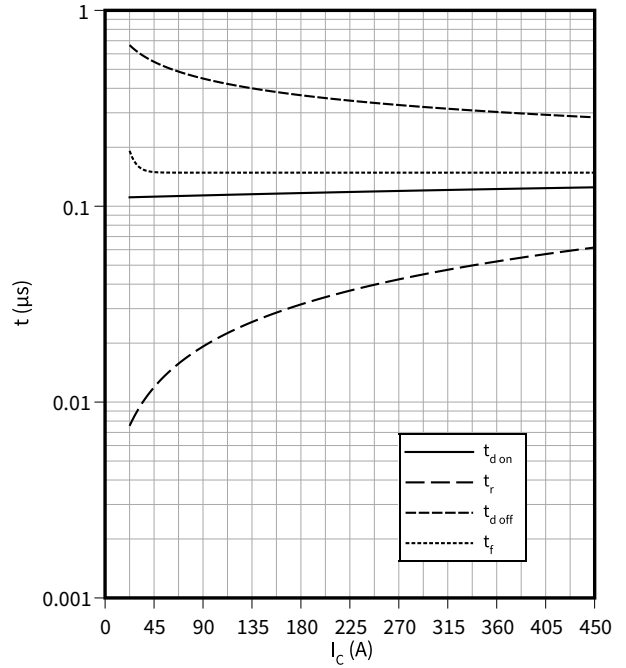

**Switching times (typical), IGBT, T1 / T4**

$t = f(R_G)$

$V_{GE} = \pm 15 \text{ V}$ ,  $I_C = 225 \text{ A}$ ,  $V_{CC} = 600 \text{ V}$ ,  $T_{vj} = 150 \text{ °C}$

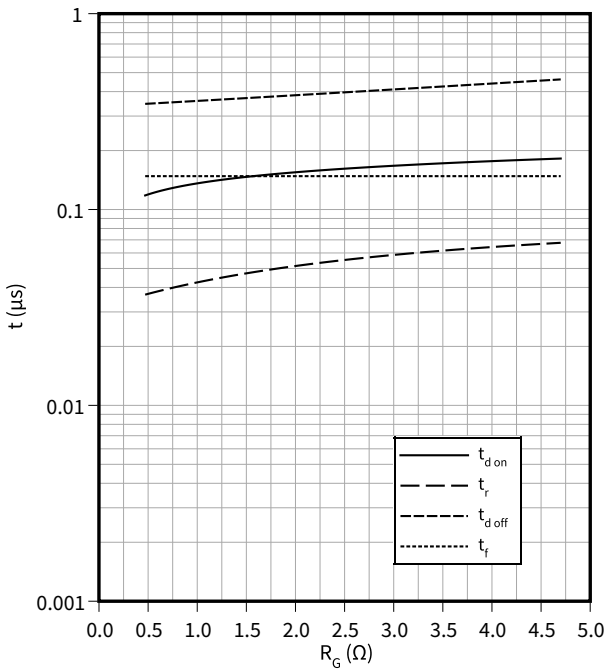

**Transient thermal impedance, IGBT, T1 / T4**

$Z_{th} = f(t)$

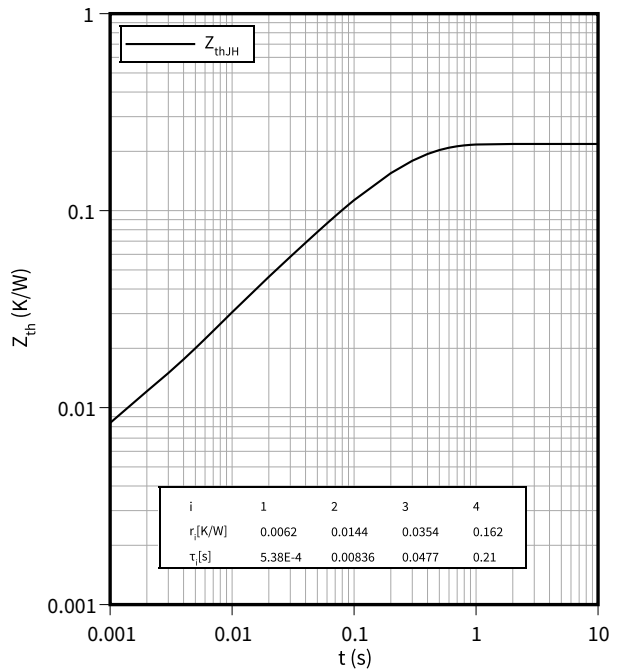

**Reverse bias safe operating area (RBSOA), IGBT, T1 / T4**

$I_C = f(V_{CE})$

$R_{Goff} = 0.47 \Omega$ ,  $V_{GE} = \pm 15 V$ ,  $T_{vj} = 150 \text{ }^\circ\text{C}$

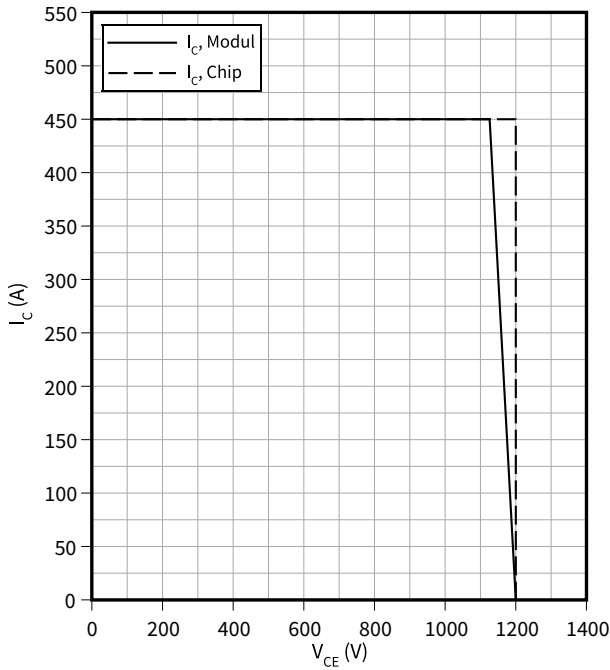

**Output characteristic (typical), IGBT, T2 / T3**

$I_C = f(V_{CE})$

$V_{GE} = 15 V$

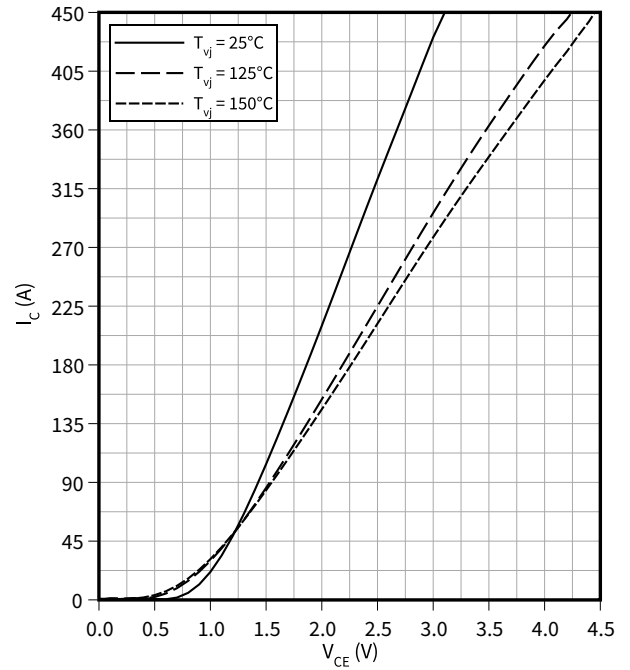

**Output characteristic field (typical), IGBT, T2 / T3**

$I_C = f(V_{CE})$

$T_{vj} = 150 \text{ }^\circ\text{C}$

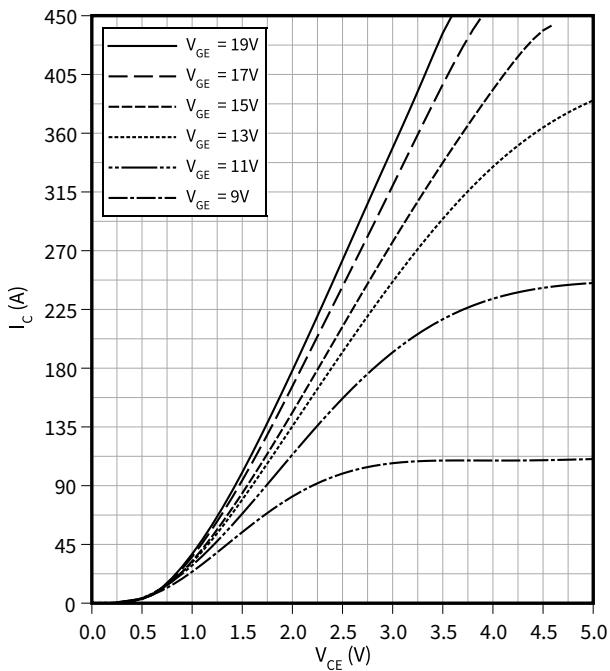

**Transfer characteristic (typical), IGBT, T2 / T3**

$I_C = f(V_{GE})$

$V_{CE} = 20 V$

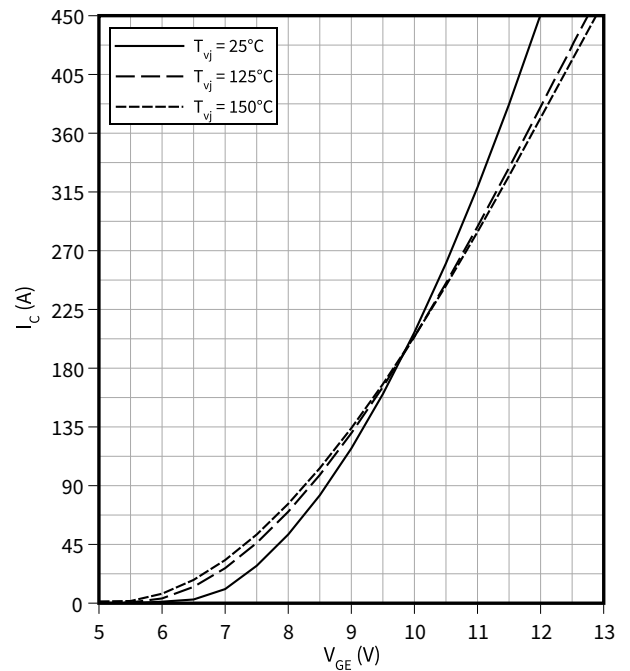

**Switching losses (typical), IGBT, T2 / T3**

$E = f(I_C)$

$R_{Goff} = 0.47 \Omega$ ,  $R_{Gon} = 0.47 \Omega$ ,  $V_{GE} = \pm 15 \text{ V}$ ,  $V_{CC} = 600 \text{ V}$

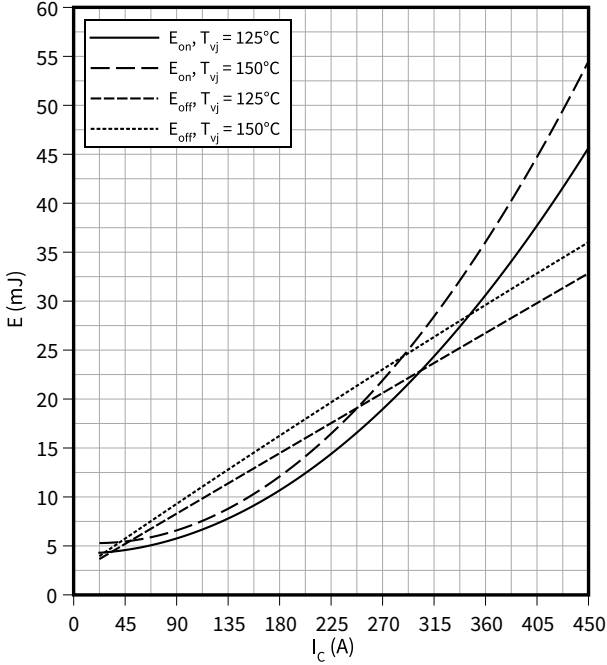

**Switching losses (typical), IGBT, T2 / T3**

$E = f(R_G)$

$I_C = 225 \text{ A}$ ,  $V_{CC} = 600 \text{ V}$ ,  $V_{GE} = -15 / 15 \text{ V}$

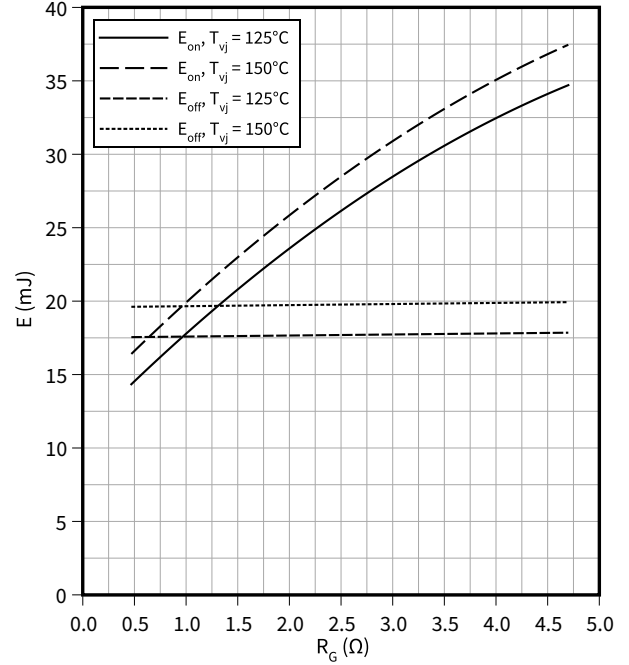

**Switching times (typical), IGBT, T2 / T3**

$t = f(I_C)$

$R_{Goff} = 0.47 \Omega$ ,  $R_{Gon} = 0.47 \Omega$ ,  $V_{GE} = \pm 15 \text{ V}$ ,  $V_{CC} = 600 \text{ V}$ ,  $T_{vj} = 150 \text{ °C}$

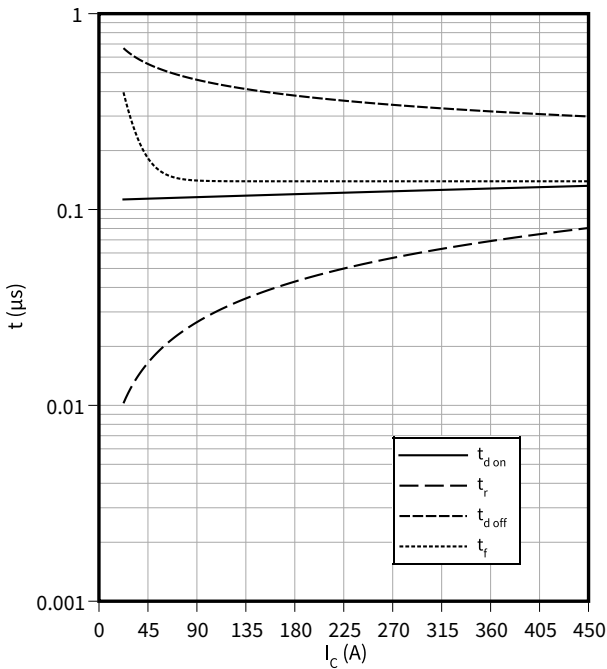

**Switching times (typical), IGBT, T2 / T3**

$t = f(R_G)$

$V_{GE} = \pm 15 \text{ V}$ ,  $I_C = 225 \text{ A}$ ,  $V_{CC} = 600 \text{ V}$ ,  $T_{vj} = 150 \text{ °C}$

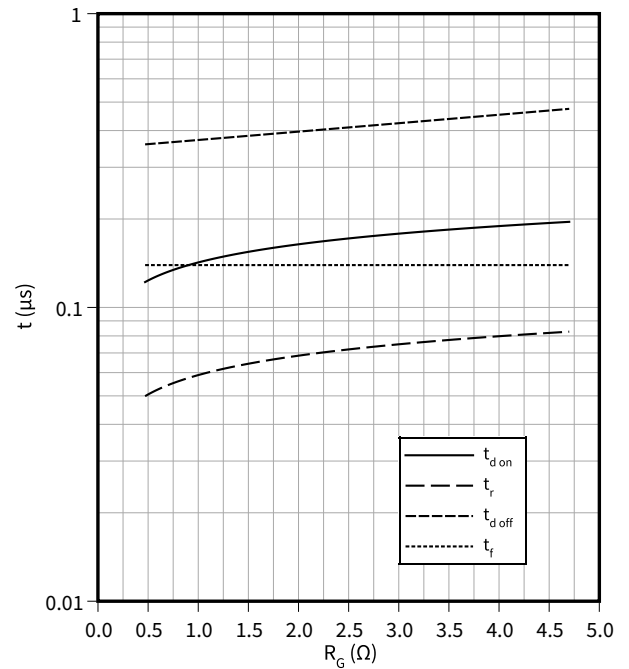

**Transient thermal impedance, IGBT, T2 / T3**

$Z_{th} = f(t)$

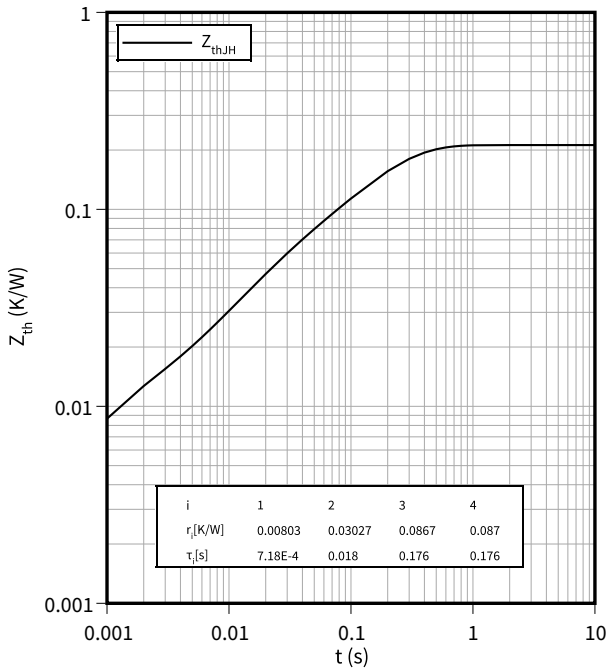

**Reverse bias safe operating area (RBSOA), IGBT, T2 / T3**

$I_C = f(V_{CE})$

$R_{Goff} = 0.47 \Omega, V_{GE} = \pm 15 V, T_{vj} = 150 \text{ }^\circ\text{C}$

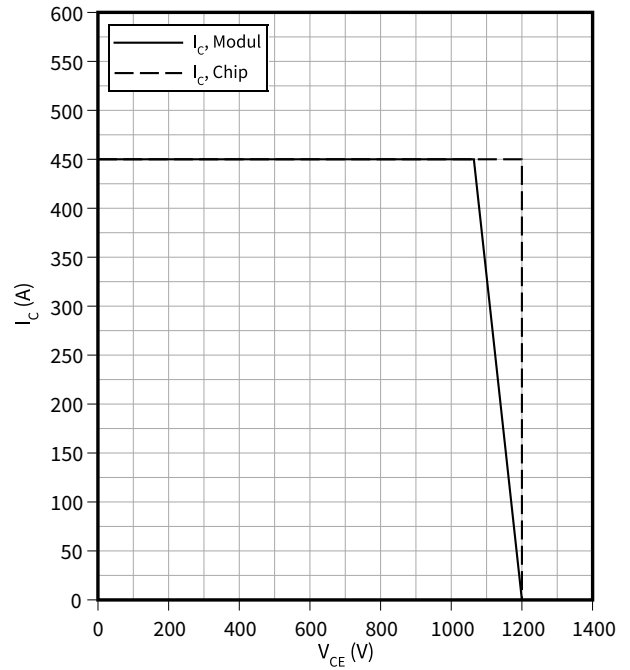

**Forward characteristic (typical), Diode, D1 / D4**

$I_F = f(V_F)$

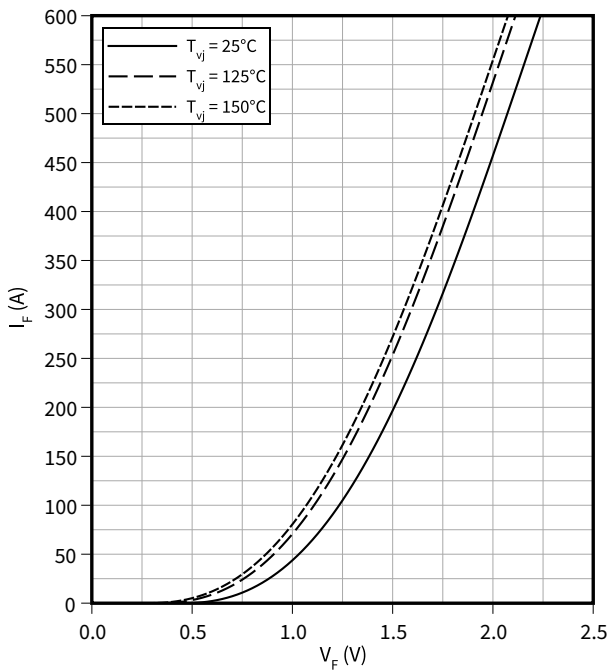

**Switching losses (typical), Diode, D1 / D4**

$E_{rec} = f(I_F)$

$R_G = 0.47 \Omega, V_{CC} = 600 V$

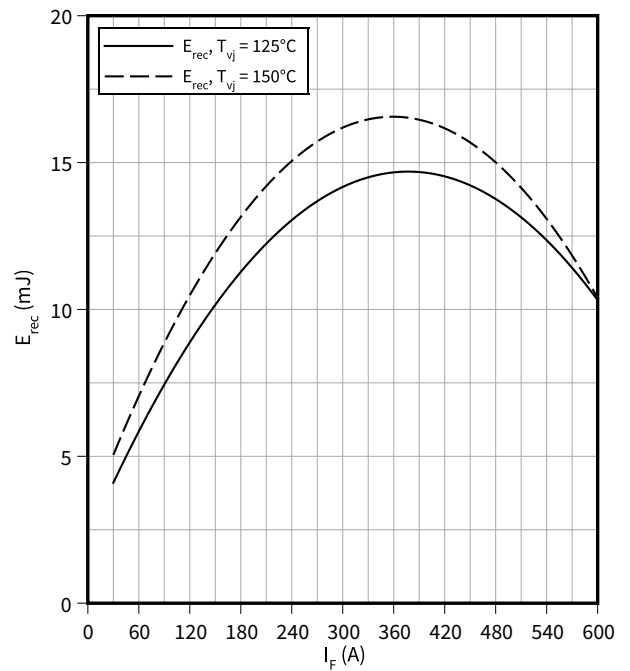

**Switching losses (typical), Diode, D1 / D4**

$E_{rec} = f(R_G)$

$I_F = 300 \text{ A}, V_{CC} = 600 \text{ V}$

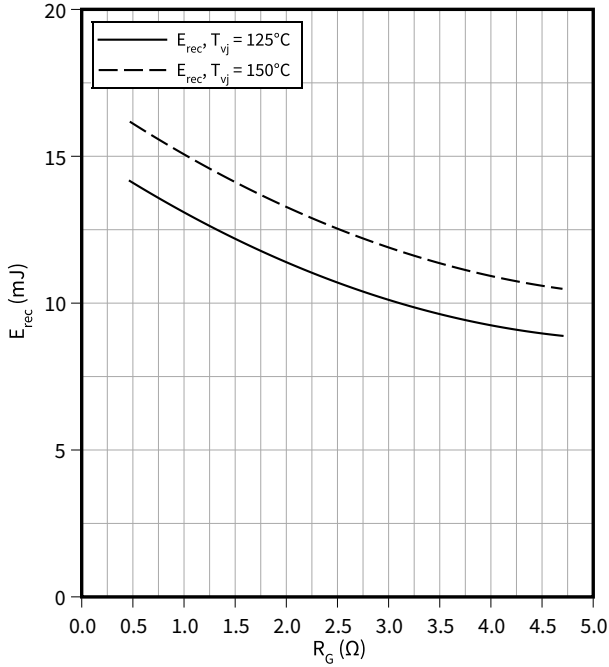

**Transient thermal impedance, Diode, D1 / D4**

$Z_{th} = f(t)$

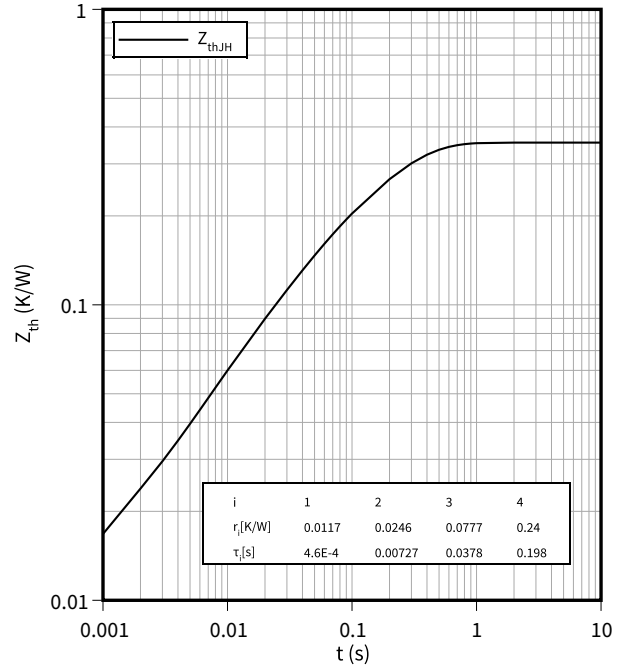

**Forward characteristic (typical), Diode, D2 / D3**

$I_F = f(V_F)$

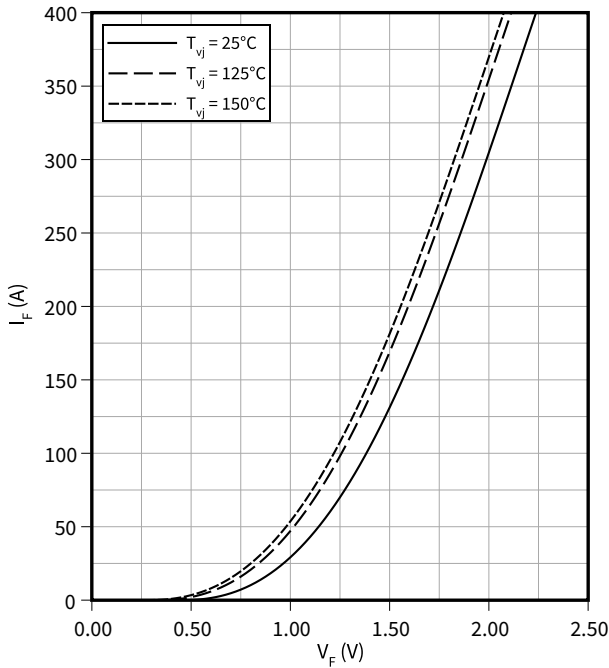

**Switching losses (typical), Diode, D2 / D3**

$E_{rec} = f(I_F)$

$R_{Gon} = 0.47 \Omega, V_{CC} = 600 \text{ V}$

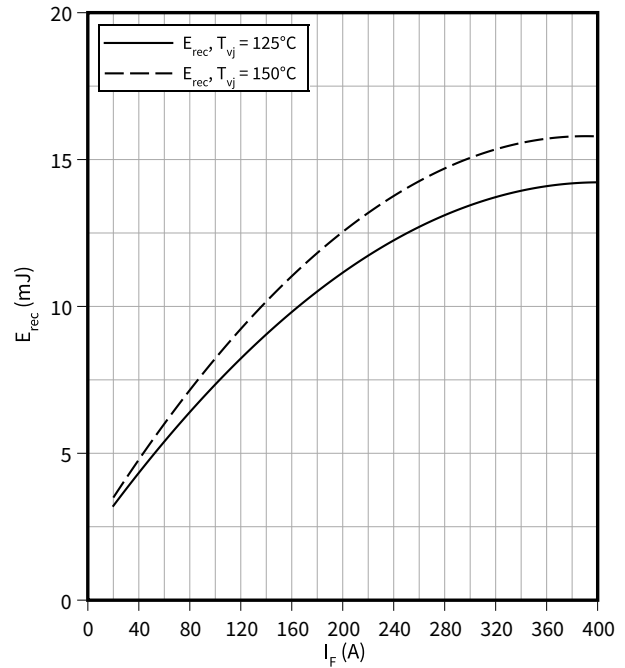

**Switching losses (typical), Diode, D2 / D3**

$E_{rec} = f(R_G)$

$I_F = 200 \text{ A}, V_{CC} = 600 \text{ V}$

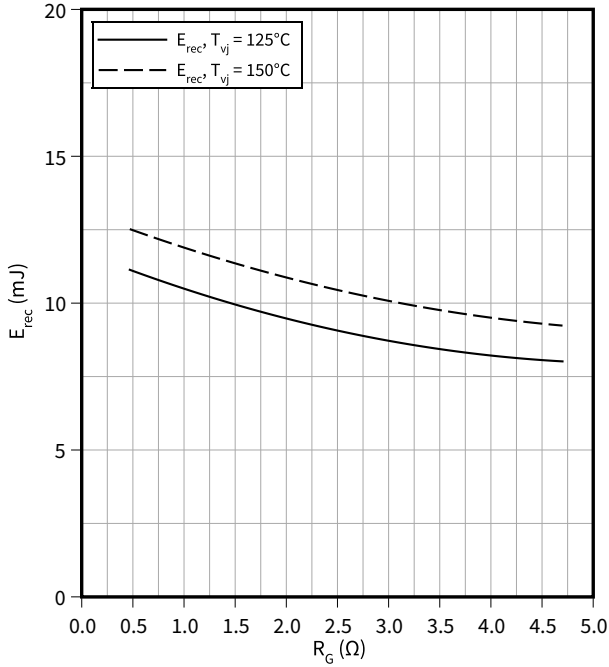

**Transient thermal impedance, Diode, D2 / D3**

$Z_{th} = f(t)$

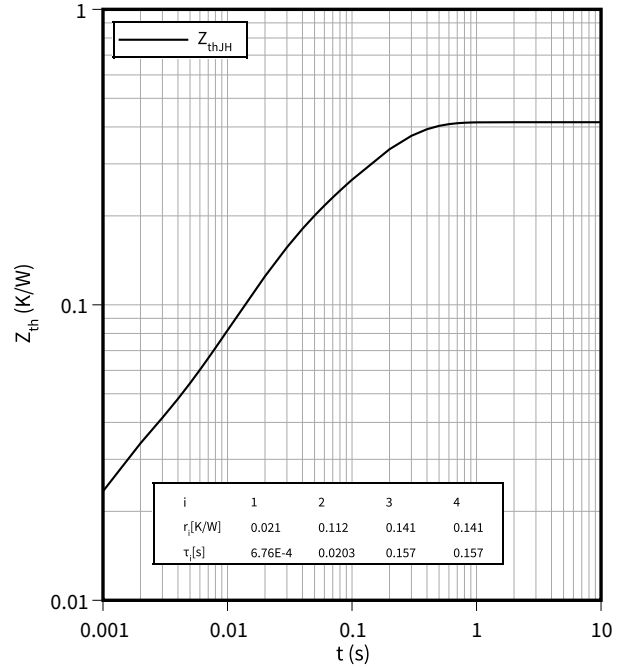

**Forward characteristic (typical), Diode, D5 / D6**

$I_F = f(V_F)$

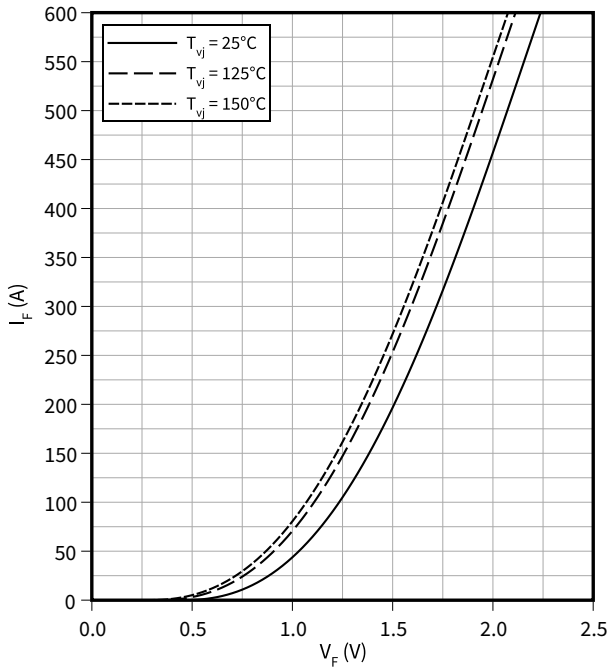

**Switching losses (typical), Diode, D5 / D6**

$E_{rec} = f(I_F)$

$R_G = 0.47 \text{ } \Omega, V_{CC} = 600 \text{ V}$

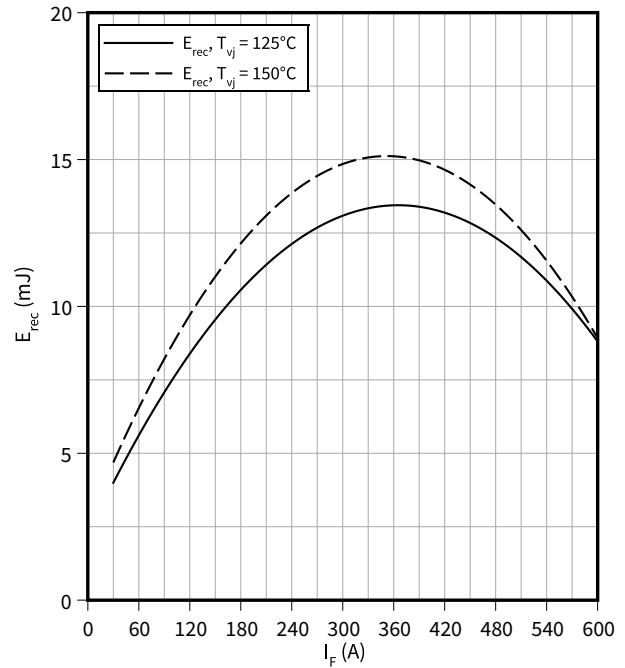



**Switching losses (typical), Diode, D5 / D6**

$E_{rec} = f(R_G)$

$I_F = 300\text{ A}, V_{CC} = 600\text{ V}$

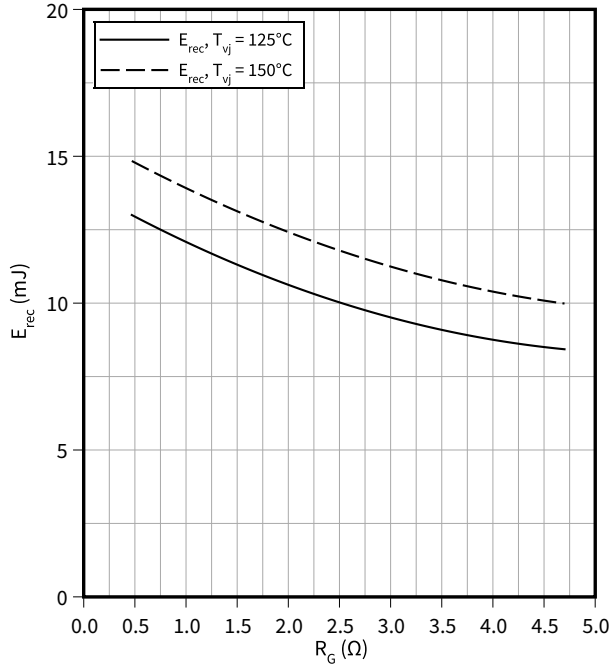

**Transient thermal impedance, Diode, D5 / D6**

$Z_{th} = f(t)$

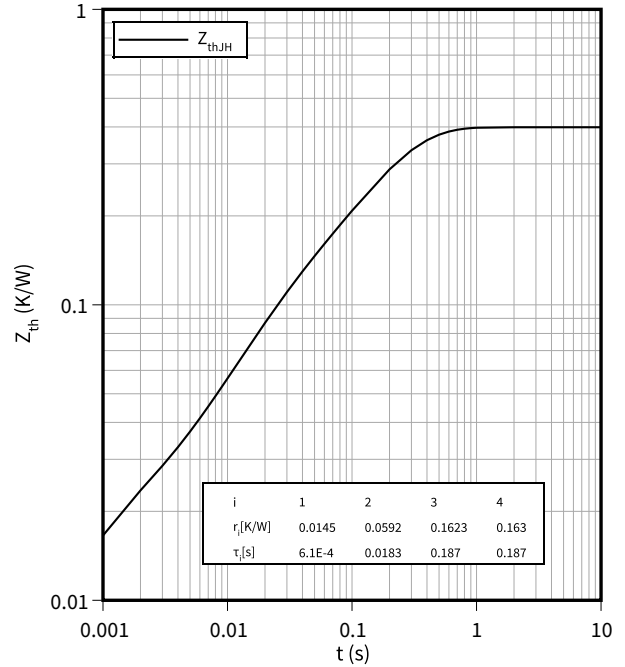

**Temperature characteristic (typical), NTC-Thermistor**

$R = f(T_{NTC})$

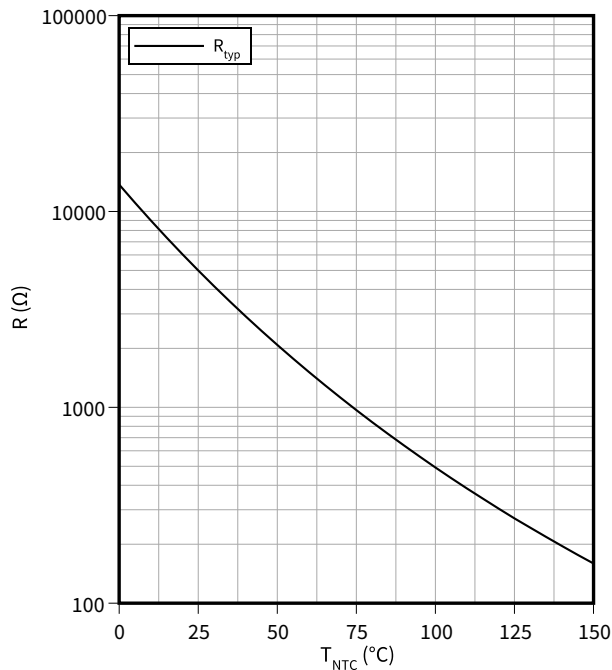

## 9 Circuit diagram

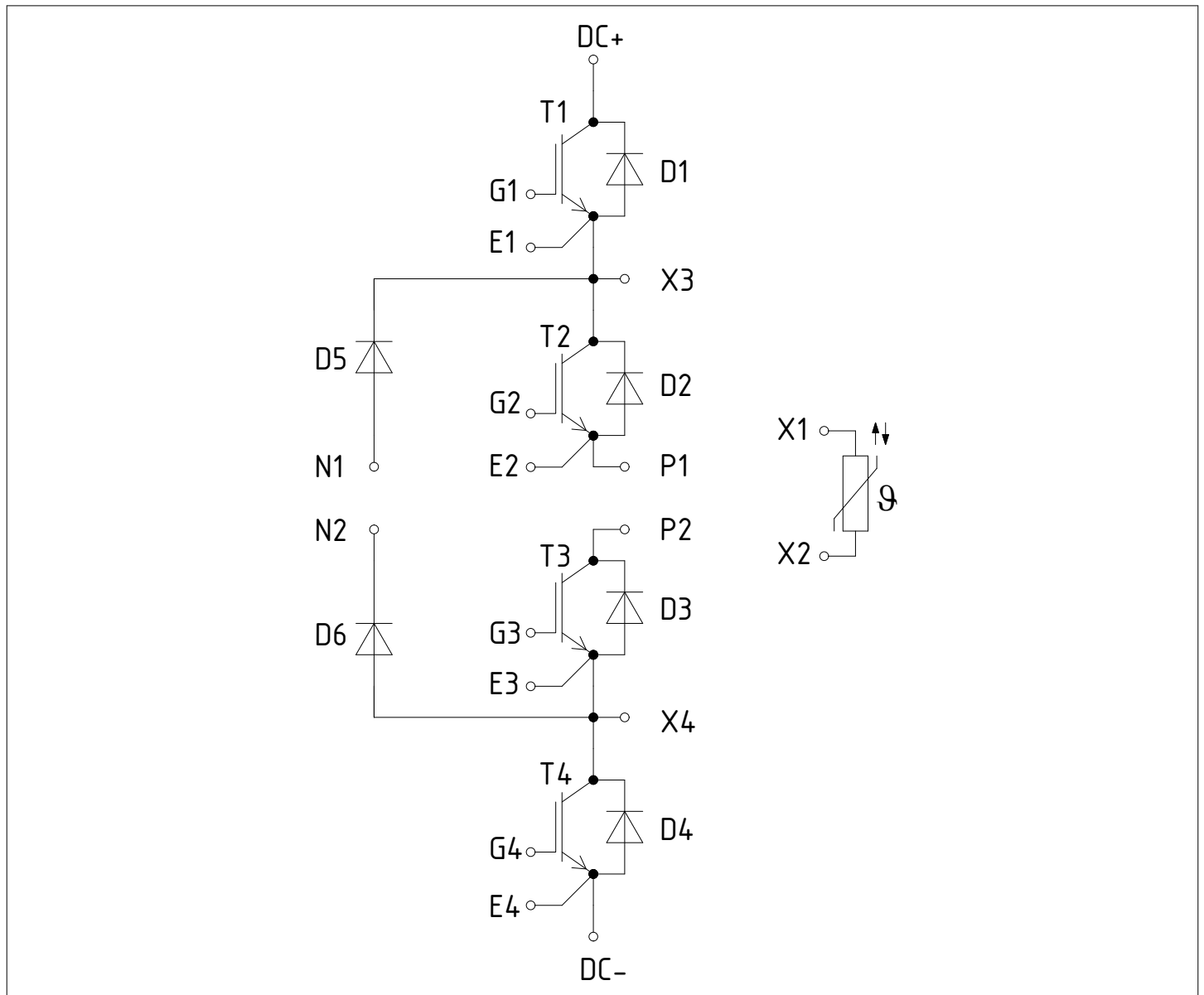

Figure 1

10 Package outlines

**10 Package outlines**

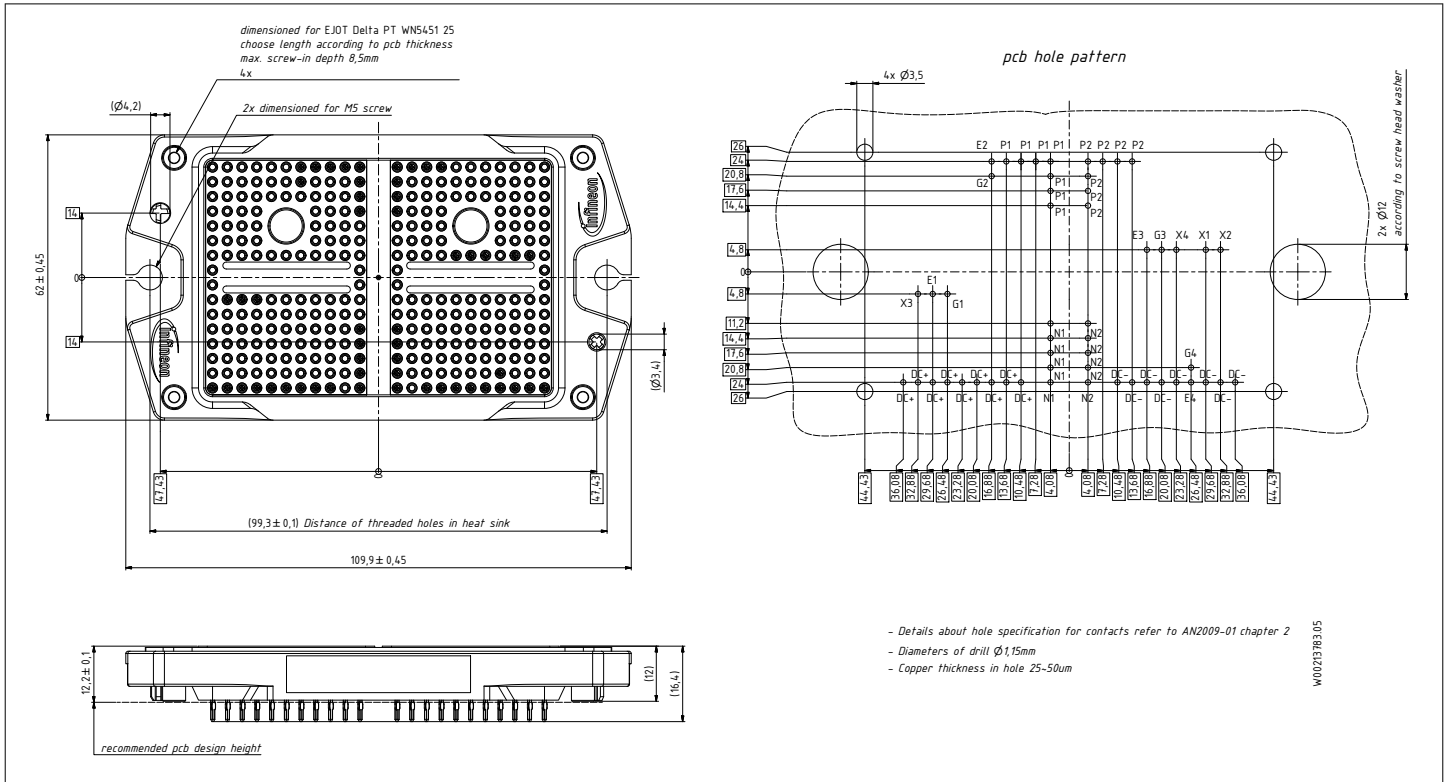

Figure 2

**11 Module label code**

Module label code			
Code format	Data Matrix	Barcode Code128	
Encoding	ASCII text	Code Set A	
Symbol size	16x16	23 digits	
Standard	IEC24720 and IEC16022	IEC8859-1	
Code content	<i>Content</i>	<i>Digit</i>	<i>Example</i>
	Module serial number	1 - 5	71549
	Module material number	6 - 11	142846
	Production order number	12 - 19	55054991
	Date code (production year)	20 - 21	15
	Date code (production week)	22 - 23	30
Example	 		
	71549142846550549911530		71549142846550549911530

Figure 3

## Revision history

Document version	Date of release	Description of changes
0.10	2022-09-16	Initial version
1.00	2023-02-13	Final datasheet

## Trademarks

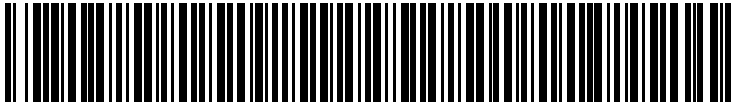
All referenced product or service names and trademarks are the property of their respective owners.

**Edition 2023-02-13**

**Published by**

**Infineon Technologies AG**

**81726 Munich, Germany**

**© 2023 Infineon Technologies AG**

**All Rights Reserved.**

**Do you have a question about any aspect of this document?**

**Email: [erratum@infineon.com](mailto:erratum@infineon.com)**

**Document reference**

**IFX-ABB158-002**

## Important notice

The information given in this document shall in no event be regarded as a guarantee of conditions or characteristics ("Beschaffheitsgarantie").

With respect to any examples, hints or any typical values stated herein and/or any information regarding the application of the product, Infineon Technologies hereby disclaims any and all warranties and liabilities of any kind, including without limitation warranties of non-infringement of intellectual property rights of any third party.

In addition, any information given in this document is subject to customer's compliance with its obligations stated in this document and any applicable legal requirements, norms and standards concerning customer's products and any use of the product of Infineon Technologies in customer's applications.

The data contained in this document is exclusively intended for technically trained staff. It is the responsibility of customer's technical departments to evaluate the suitability of the product for the intended application and the completeness of the product information given in this document with respect to such application.

## Warnings

Due to technical requirements products may contain dangerous substances. For information on the types in question please contact your nearest Infineon Technologies office.

Except as otherwise explicitly approved by Infineon Technologies in a written document signed by authorized representatives of Infineon Technologies, Infineon Technologies' products may not be used in any applications where a failure of the product or any consequences of the use thereof can reasonably be expected to result in personal injury.

# Mouser Electronics

Authorized Distributor

Click to View Pricing, Inventory, Delivery & Lifecycle Information:

[Infineon:](#)

[F3L225R12W3H3B11BPSA1](#)