

GaAs PHEMT MMIC MEDIUM POWER AMPLIFIER, 7 - 15.5 GHz

Typical Applications

The HMC441LH5 is a medium PA for:

- Telecom Infrastructure
- Military Radio, Radar & ECM
- Space Systems
- Test Instrumentation

Features

- Gain: 5 dB
- Saturated Power: +21.5 dBm @ 25% PAE
- Single Positive Supply: +5V
- 50 Ohms Matched Input/Output
- Hermetic SMT Package, 25mm²
- Screening to MIL-PRF-38535 (Class B or S) Available

Functional Diagram

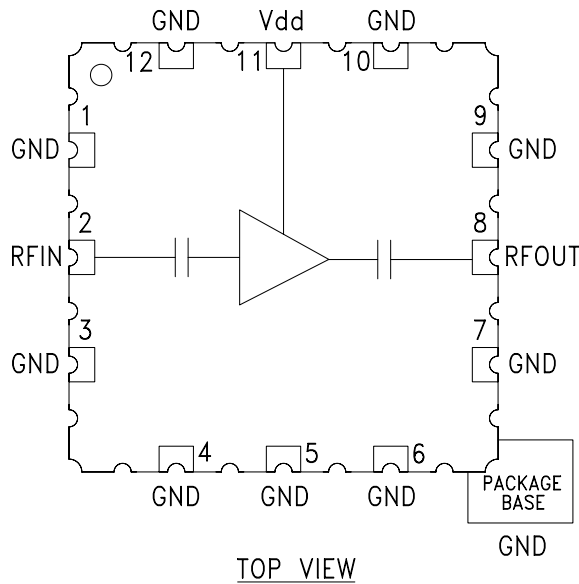

General Description

The HMC441LH5 is a broadband 7 to 15.5 GHz GaAs PHEMT MMIC Medium Power Amplifier housed in a hermetic SMT leadless package. The amplifier provides 15 dB of gain and 21.5 dBm of saturated power at 25% PAE from a +5V supply. This 50 Ohm matched amplifier does not require any external components, and the RF I/Os are DC blocked, making it an ideal linear gain block or driver amplifier. The HMC441LH5 allows the use of surface mount manufacturing techniques and is suitable for high reliability military, industrial & space applications.

Electrical Specifications, $T_A = +25^\circ \text{C}$, $V_{dd} = 5\text{V}$

Parameter	Min.	Typ.	Max.	Min.	Typ.	Max.	Min.	Typ.	Max.	Min.	Typ.	Max.	Units
Frequency Range	7.0 - 8.0			8.0 - 13.0			13.0 - 14.0			14.0 - 15.5			GHz
Gain	11	14		13	16		12	15		10.5	13.5		dB
Gain Variation Over Temperature		0.015	0.02		0.015	0.02		0.015	0.02		0.015	0.02	dB/°C
Input Return Loss		11			13			10			8		dB
Output Return Loss		10			15			14			12		dB
Output Power for 1 dB Compression (P1dB)	15.5	18.5		17	20		16	19		16	19		dBm
Saturated Output Power (Psat)		20			21			21.5			21		dBm
Output Third Order Intercept (IP3)		30			32			32			32		dBm
Noise Figure		5.0			4.75			4.75			5.0		dB
Supply Current (I _{dd})		90	115		90	115		90	115		90	115	mA

GaAs PHEMT MMIC MEDIUM POWER AMPLIFIER, 7 - 15.5 GHz

Broadband Gain & Return Loss

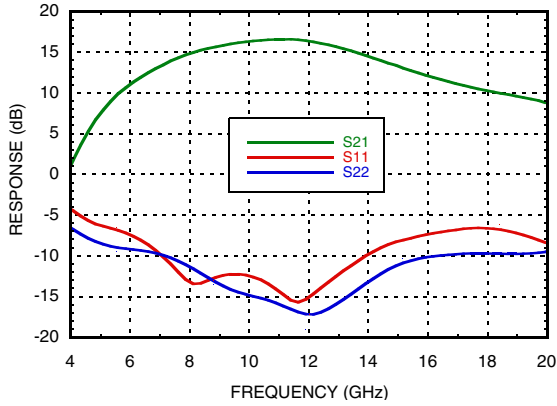

Gain vs. Temperature

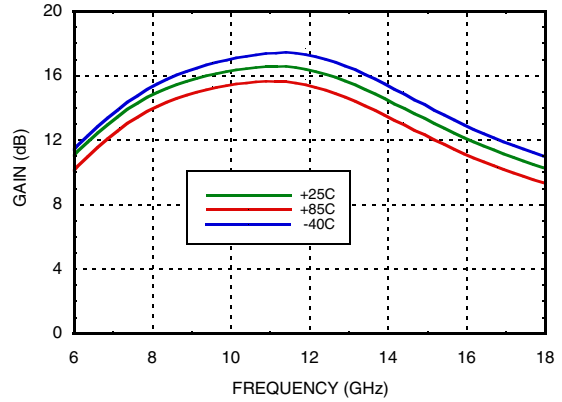

Input Return Loss vs. Temperature

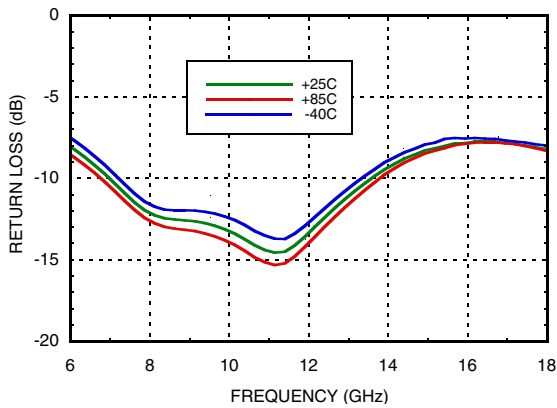

Output Return Loss vs. Temperature

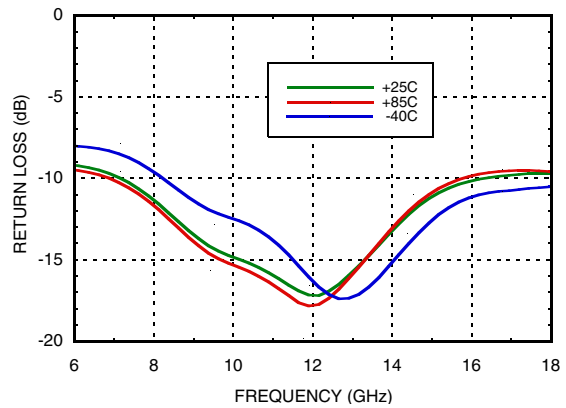

P1dB vs. Temperature

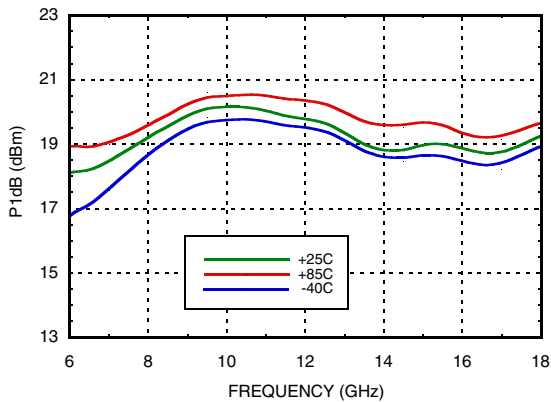

Psat vs. Temperature

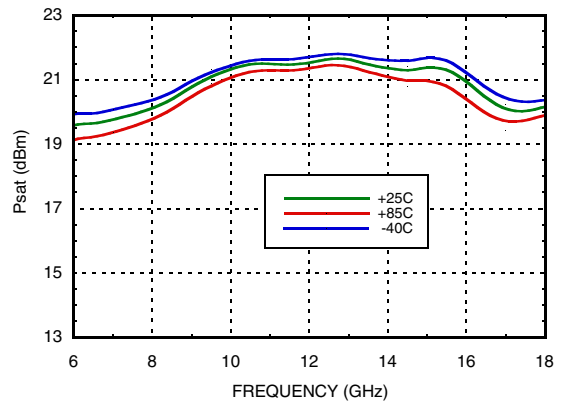

GaAs PHEMT MMIC MEDIUM POWER AMPLIFIER, 7 - 15.5 GHz

Power Compression @ 12 GHz

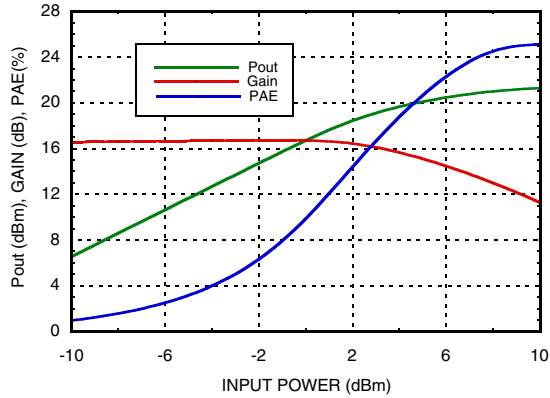

Output IP3 vs. Temperature

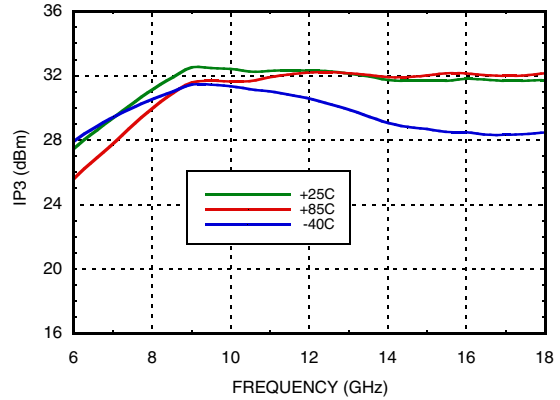

Gain, Power & Output IP3 vs. Supply Voltage @ 12 GHz

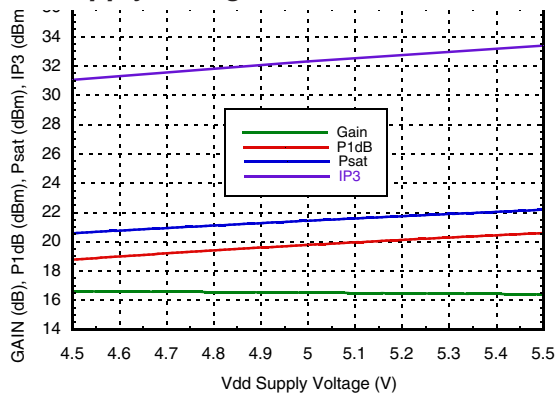

Noise Figure vs. Temperature

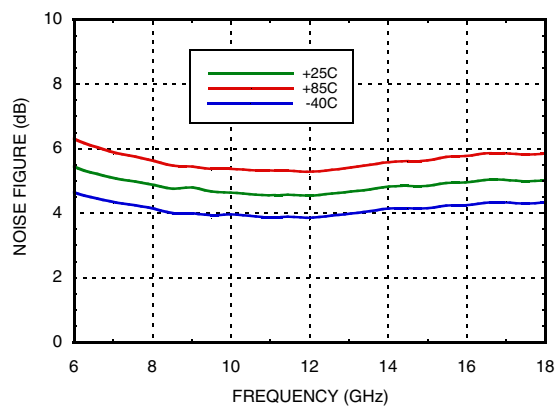

Reverse Isolation vs. Temperature

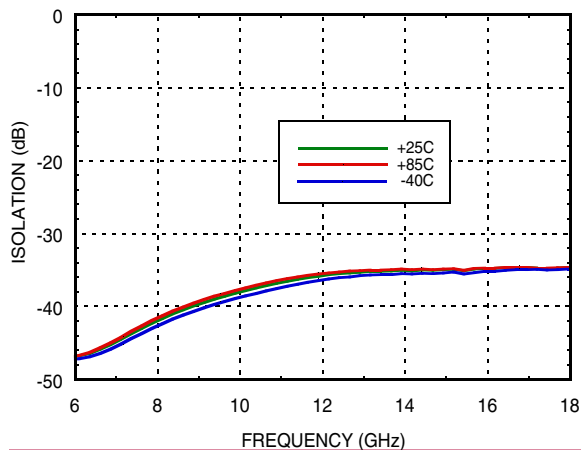

Additive Phase Noise Vs Offset Frequency, RF Frequency = 8 GHz, RF Input Power = 5 dBm (P1dB)

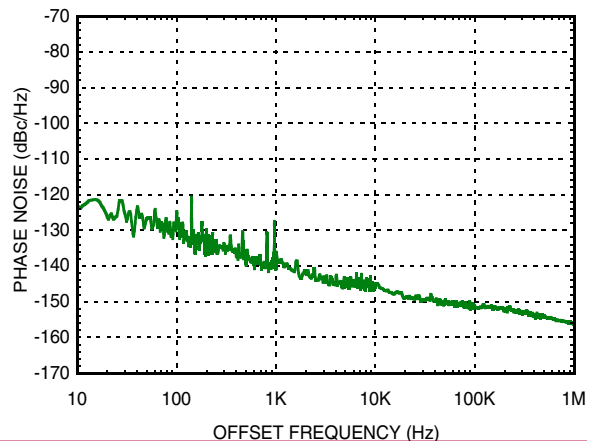

GaAs PHEMT MMIC MEDIUM POWER AMPLIFIER, 7 - 15.5 GHz

Absolute Maximum Ratings

Drain Bias Voltage (Vdd)	+6 Vdc
RF Input Power (RFIN)(Vdd = +5Vdc)	+15 dBm
Channel Temperature	175 °C
Continuous Pdiss (T = 85 °C) (derate 8.4 mW/°C above 85 °C)	0.76 W
Thermal Resistance (channel to ground paddle)	118.8 °C/W
Storage Temperature	-65 to +150 °C
Operating Temperature	-40 to +85 °C

Typical Supply Current vs. Vdd

Vdd (V)	Idd (mA)
+5.5	92
+5.0	90
+4.5	88

Note: Amplifier will operate over full voltage range shown above



ELECTROSTATIC SENSITIVE DEVICE
OBSERVE HANDLING PRECAUTIONS

Outline Drawing

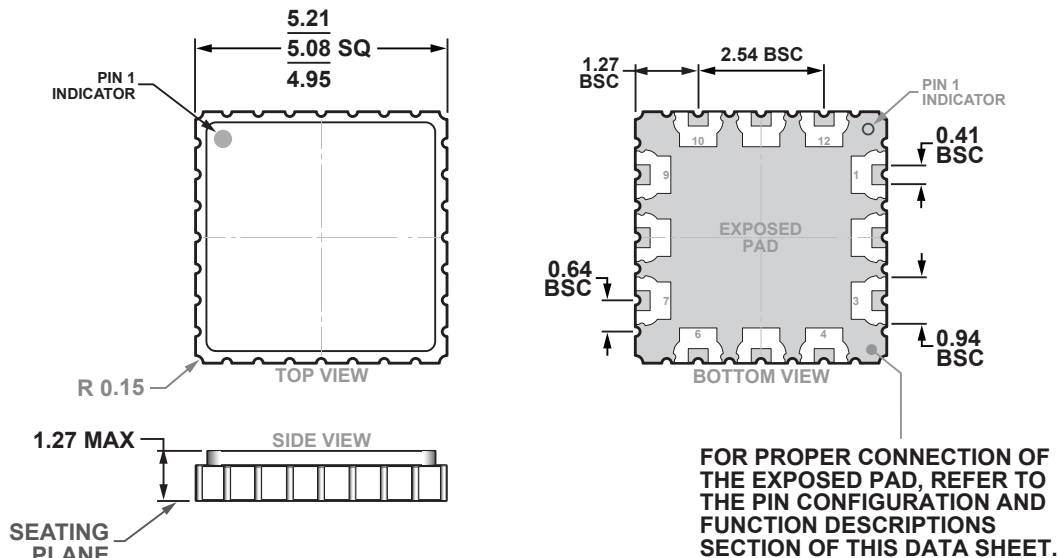

PKG-0101000

12-19-2016-A

12-Terminal Ceramic Leadless Chip Carrier [LCC]
(E-12-3)

Dimensions shown in millimeters.

Package Information

Part Number	Package Body Material	Lead Finish	MSL Rating	Package Marking ^[2]
HMC441LH5	Ceramic and Kovar	Gold	MSL1 ^[1]	H441 XXXX

[1] Max peak reflow temperature of 250 °C

[2] 4-Digit lot number XXXX

GaAs PHEMT MMIC MEDIUM POWER AMPLIFIER, 7 - 15.5 GHz

Pin Descriptions

Pin Number	Function	Description	Interface Schematic
1, 3-7, 9, 10, 12	GND	These pins and package bottom must be connected to RF/DC ground.	
2	RFIN	This pin is AC coupled and matched to 50 Ohms.	
8	RFOUT	This pin is AC coupled and matched to 50 Ohms.	
11	Vdd	Power Supply Voltage for the amplifier. External bypass capacitors are recommended.	

Application Circuit

Component	Value
C1	100 pF
C2	1,000 pF
C3	4.7 μF

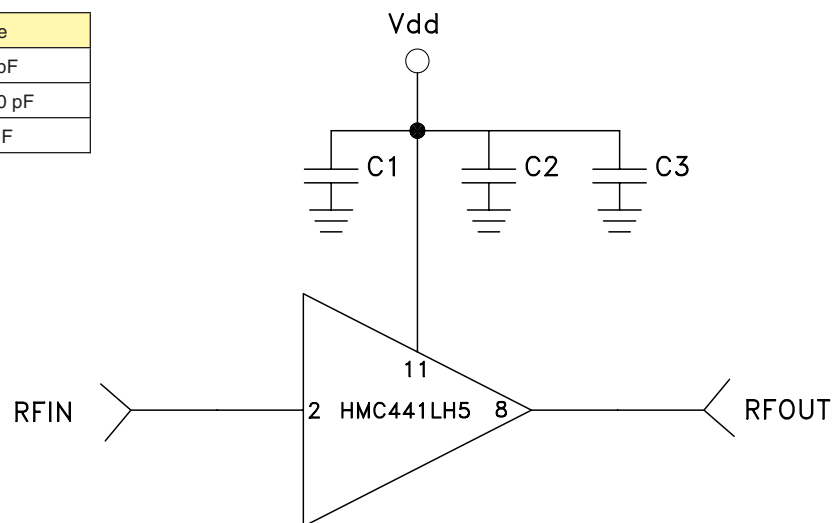

GaAs PHEMT MMIC MEDIUM POWER AMPLIFIER, 7 - 15.5 GHz

Evaluation PCB

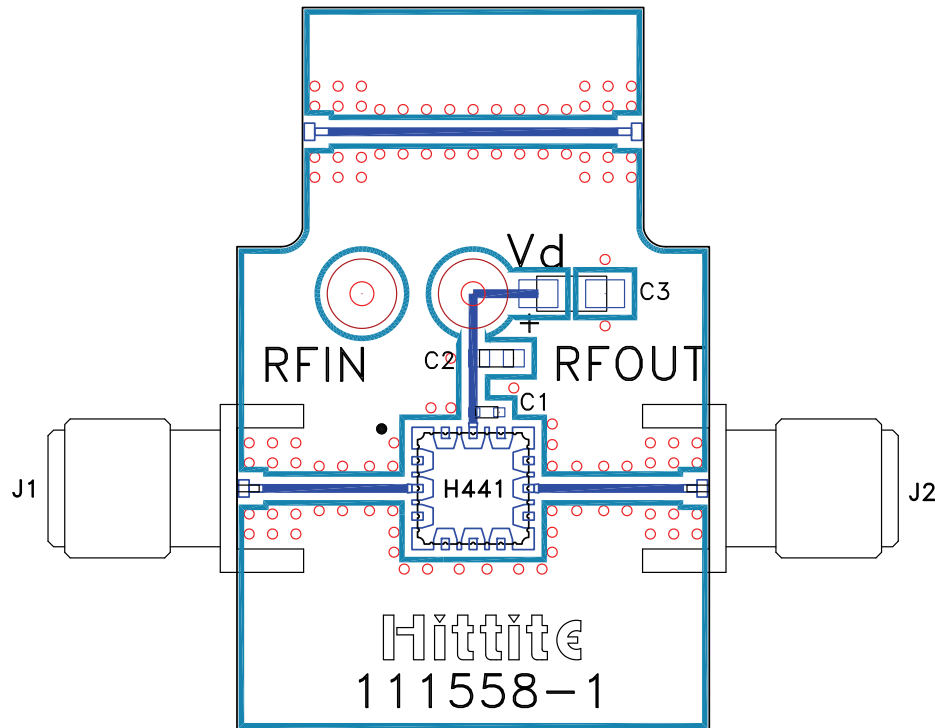

List of Materials for Evaluation PCB 111560 [1]

Item	Description
J1 - J2	PCB Mount SMA RF Connector, SRI
U1	HMC441LH5
C1	100 pF Capacitor, 0402 Pkg.
C2	1,000 pF Capacitor, 0603 Pkg.
C3	4.7 μ F Capacitor, Tantalum
PCB [2]	111558 Evaluation Board

[1] Reference this number when ordering complete evaluation PCB

[2] Circuit Board Material: Rogers 4350

The circuit board used in the final application should use RF circuit design techniques. Signal lines should have 50 Ohm impedance while the package ground leads and exposed paddle should be connected directly to the ground plane similar to that shown. A sufficient number of via holes should be used to connect the top and bottom ground planes. The evaluation circuit board shown is available from Analog Devices upon request.

Mouser Electronics

Authorized Distributor

Click to View Pricing, Inventory, Delivery & Lifecycle Information:

[Analog Devices Inc.:](#)

[111560-HMC441LH5](#)