

## GaAs PHEMT MMIC DRIVER AMPLIFIER, 18 - 40 GHz

### Typical Applications

The HMC635LC4 is ideal for:

- Point-to-Point Radios
- Point-to-Multi-Point Radios & VSAT
- LO Driver for Mixers
- Military & Space

### Features

- Gain: 18.5 dB <sup>[2]</sup>
- P1dB: +22 dBm <sup>[2]</sup>
- Output IP3: +27 dBm
- Saturated Power: +23.5 dBm @ 15% PAE <sup>[2]</sup>
- Supply Voltage: +5V @ 280 mA
- 50 Ohm Matched Input/Output
- 24 Lead Ceramic 4x4mm SMT Package: 16mm<sup>2</sup>

### Functional Diagram

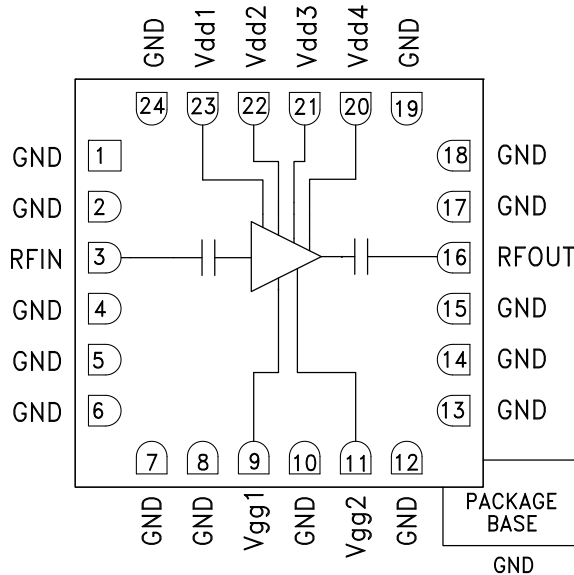

### General Description

The HMC635LC4 is a GaAs PHEMT MMIC Driver Amplifier die which operates between 18 and 40 GHz. The amplifier provides 18.5 dB of gain, +27 dBm Output IP3, and +22 dBm of output power at 1 dB gain compression, while requiring 280 mA from a +5V supply. Ideal as a driver amplifier for microwave radio applications, or as an LO driver for mixers operating between 18 and 40 GHz, the HMC635LC4 is capable of providing up to +23.5 dBm of saturated output power at 15% PAE. The amplifier's I/Os are DC blocked and internally matched to 50 Ohms making it ideal for integration into Multi-Chip-Modules (MCMs).

### Electrical Specifications

$$T_A = +25^\circ \text{C}, V_{dd} = V_{dd1}, 2, 3, 4 = +5\text{V}, I_{dd} = I_{dd1} + I_{dd2} + I_{dd3} + I_{dd4} = 280\text{mA} \text{ [1]}$$

Parameter	Min.	Typ.	Max.	Min.	Typ.	Max.	Units
Frequency Range	18 - 36		36 - 40				
Gain <sup>[2]</sup>	15	18.5		15	17.5		dB
Gain Variation Over Temperature		0.045	0.06		0.045	0.06	dB/ °C
Input Return Loss		13			7		dB
Output Return Loss		10			7		dB
Output Power for 1 dB Compression (P1dB) <sup>[2]</sup>	19	22		16	21		dBm
Saturated Output Power (P <sub>sat</sub> ) <sup>[2]</sup>		23.5			21.5		dBm
Output Third Order Intercept (IP3)	22	27		21	26		dBm
Noise Figure <sup>[2]</sup>		7			7		dB
Total Supply Current (I <sub>dd1</sub> + I <sub>dd2</sub> + I <sub>dd3</sub> + I <sub>dd4</sub> )		280			280		mA

[1] Adjust Vgg1 = Vgg2 between -2 to 0V to achieve I<sub>dd</sub> = 280 mA Typical.

[2] Board loss subtracted out for gain, power and noise figure measurements.

**GaAs PHEMT MMIC DRIVER  
AMPLIFIER, 18 - 40 GHz**

**Broadband Gain & Return Loss [1]**

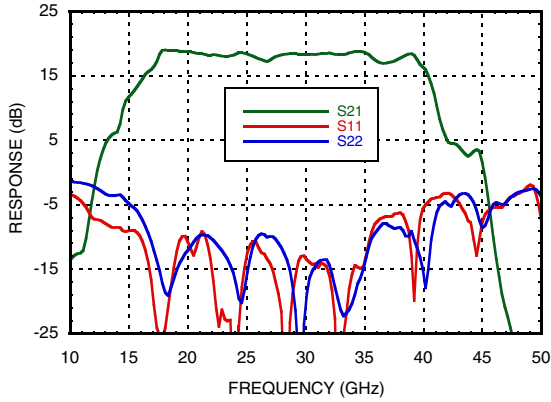

**Gain vs. Temperature [1]**

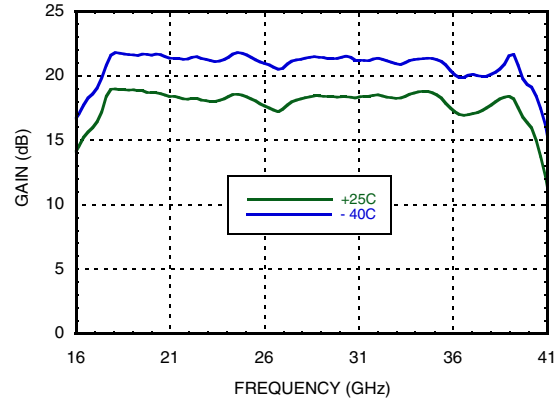

**Input Return Loss vs. Temperature**

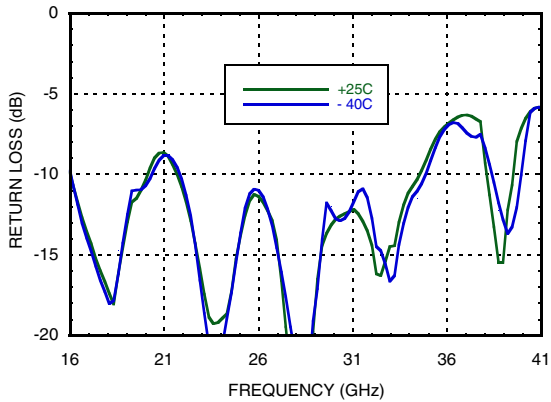

**Output Return Loss vs. Temperature**

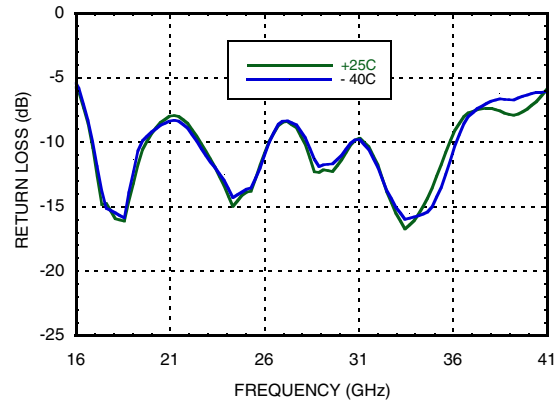

**P1dB vs. Temperature [1]**

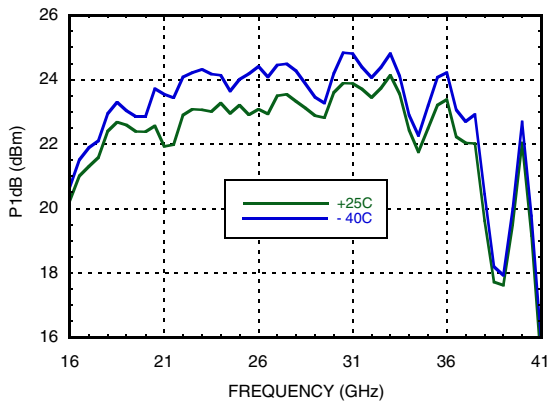

**Psat vs. Temperature [1]**

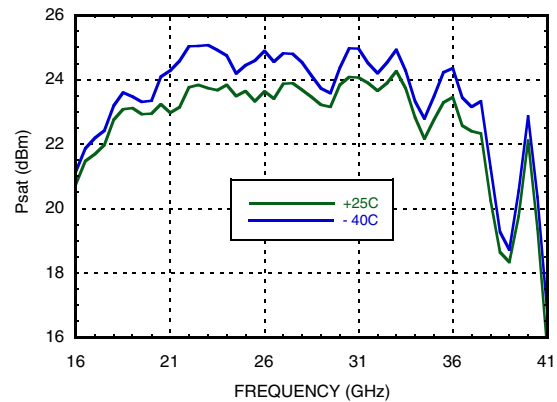

[1] Board loss subtracted out for gain, power and noise figure measurements.

**GaAs PHEMT MMIC DRIVER AMPLIFIER, 18 - 40 GHz**

**Power Compression @ 30 GHz [1]**

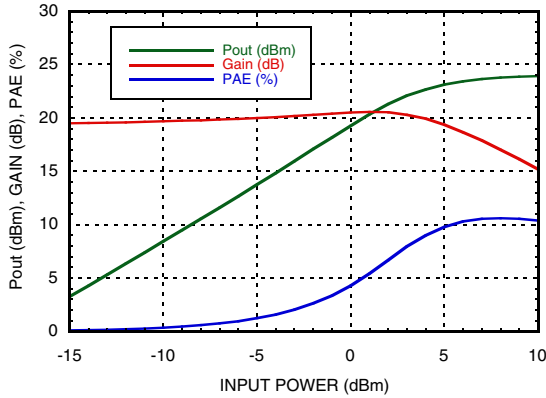

**Power Compression @ 40 GHz [1]**

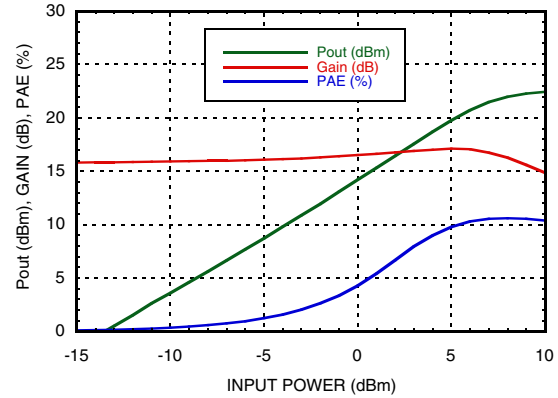

**Output IP3 vs. Temperature**

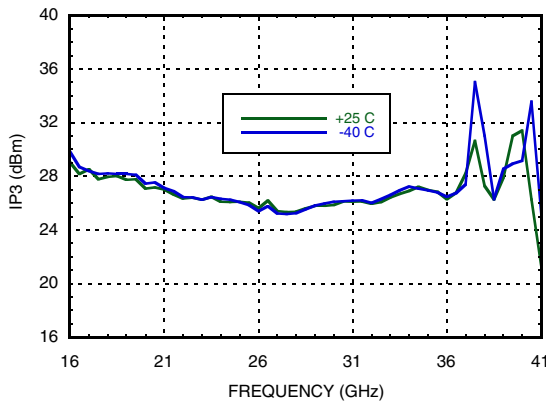

**Noise Figure vs. Temperature [1]**

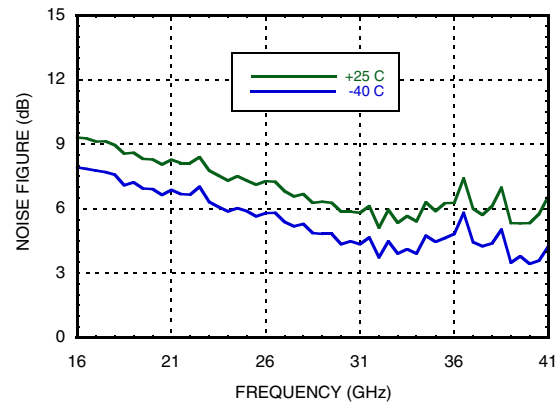

**Gain & Power vs. Supply Voltage @ 30 GHz [1]**

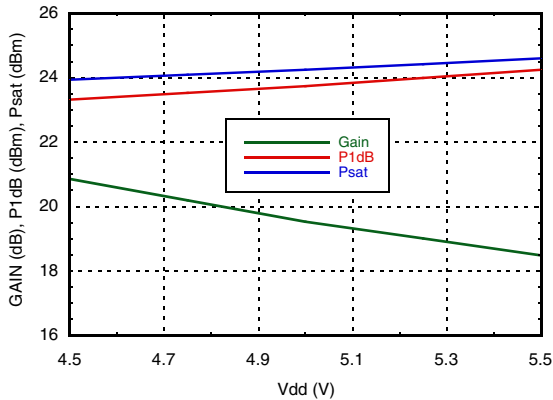

**Reverse Isolation vs. Temperature**

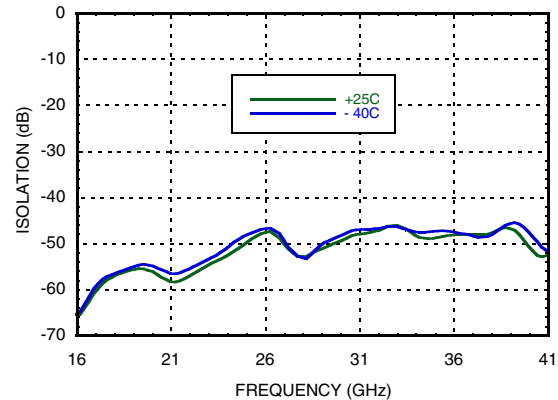

[1] Board loss subtracted out for gain, power and noise figure measurements.

## GaAs PHEMT MMIC DRIVER AMPLIFIER, 18 - 40 GHz

### Absolute Maximum Ratings

Drain Bias Voltage (Vdd1, 2, 3, 4)	+5.5V
Gate Bias Voltage (Vgg1, Vgg2)	-3 to 0V
RF Input Power (RFIN)(Vdd = +5 Vdc)	15 dBm
Channel Temperature	175 °C
Continuous Pdiss (T= 70 °C) (derate 15.1 mW/°C above 70 °C)	1.575 W
Thermal Resistance (channel to package base)	66.4 °C/W
Storage Temperature	-65 to +150 °C
Operating Temperature	-55 to +85 °C

### Typical Supply Current vs. Vdd

Vdd (V)	Idd (mA)
4.5	277
5.0	280
5.5	286

Note: Amplifier will operate over full voltage ranges shown above



**ELECTROSTATIC SENSITIVE DEVICE  
OBSERVE HANDLING PRECAUTIONS**

### Outline Drawing

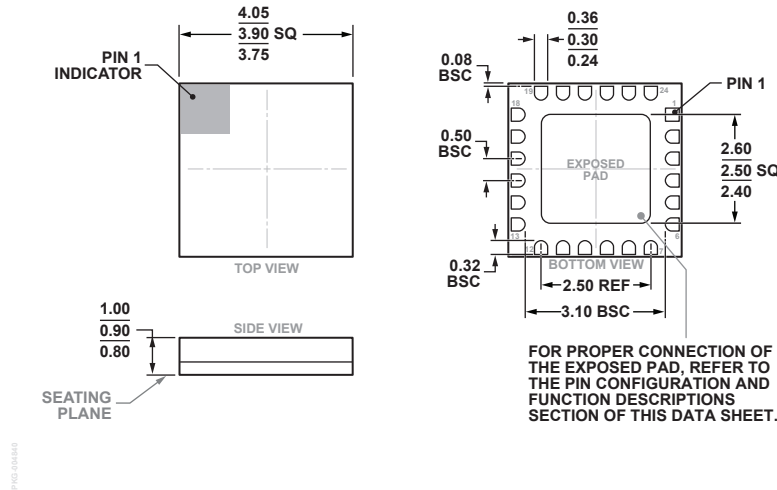

24-Terminal Ceramic Leadless Chip Carrier [LCC]  
(E-24-1)

Dimensions shown in millimeters.

### Package Information

Part Number	Package Body Material	Lead Finish	MSL Rating	Package Marking <sup>[2]</sup>
HMC635LC4	Alumina, White	Gold over Nickel	MSL3 <sup>[1]</sup>	H635 XXXX

[1] Max peak reflow temperature of 260 °C

[2] 4-Digit lot number XXXX

## GaAs PHEMT MMIC DRIVER AMPLIFIER, 18 - 40 GHz

### Pin Descriptions

Pin Number	Function	Description	Interface Schematic
1, 2, 4 - 8, 10, 12 - 15, 17 - 19, 24, Ground Paddle	GND	These pins and package bottom must be connected to RF/DC ground	
3	RFIN	This pad is AC coupled and matched to 50 Ohms.	
16	RFOUT	This pad is AC coupled and matched to 50 Ohms.	
9, 11	Vgg1, Vgg2	Gate control for amplifier, please follow "MMIC Amplifier Biasing Procedure" application note. See assembly diagram for required external components.	
20 - 23	Vdd4 - Vdd1	Power Supply Voltage for the amplifier. See assembly diagram for required external components.	

### Application Circuit

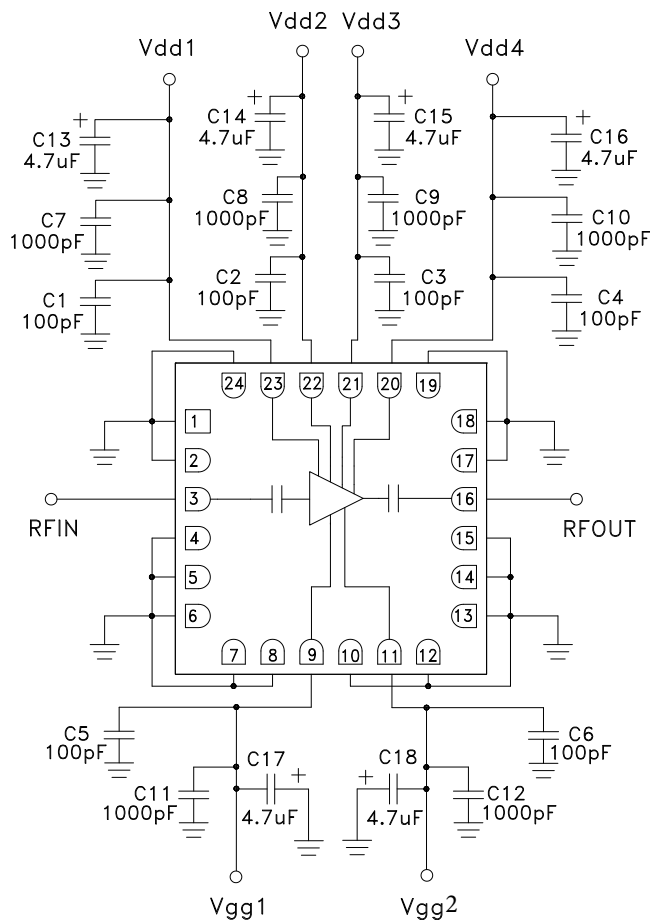

## GaAs PHEMT MMIC DRIVER AMPLIFIER, 18 - 40 GHz

### Evaluation PCB

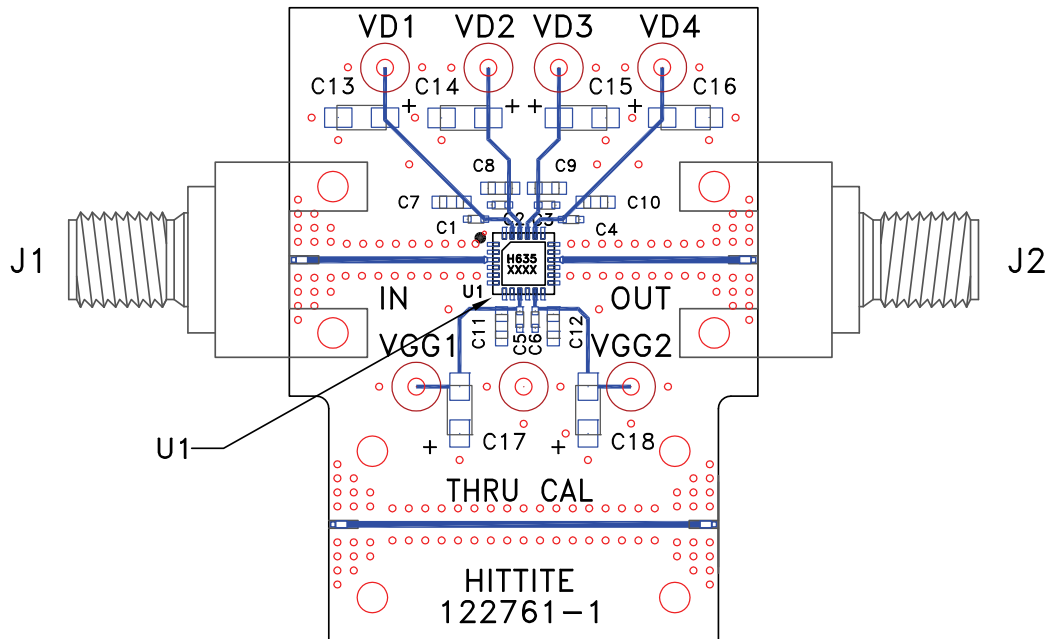

### List of Materials for Evaluation 122763 <sup>[1]</sup>

Item	Description
J1 - J2	2.92 mm PC Mount K-Connector
VD1 - VD4, VGG1, VGG2	DC Pin
C1 - C6	100 pF Capacitor, 0402 Pkg.
C7 - C12	1000 pF Capacitor, 0603 Pkg.
C13 - C18	4.7 $\mu$ F Capacitor, Tantalum, Case A
U1	HMC635LC4 Driver Amplifier
PCB <sup>[2]</sup>	122761 Evaluation PCB <sup>[3]</sup>

[1] Reference this number when ordering complete evaluation PCB

[2] Circuit Board Material: Rogers 4350 or Arlon 25FR

[3] Due to the very high frequency operation of this product a custom LC4 PCB footprint and solder stencil are required for this design. Performance shown in this data sheet was produced using this custom footprint. DO NOT USE Hittite's standard LC4 footprint. Please contact Applications for details.

The circuit board used in the application should use RF circuit design techniques. Signal lines should have 50 Ohm impedance while the package ground leads and exposed paddle should be connected directly to the ground plane similar to that shown. A sufficient number of via holes should be used to connect the top and bottom ground planes. The evaluation board should be mounted to an appropriate heat sink. The evaluation circuit board shown is available from Analog Devices upon request.

# Mouser Electronics

Authorized Distributor

Click to View Pricing, Inventory, Delivery & Lifecycle Information:

[Analog Devices Inc.:](#)

[HMC635LC4](#) [HMC635LC4TR](#) [122763-HMC635LC4](#)