

### General Description

The 885128 is a high-performance, high power Bulk Acoustic Wave (BAW) band-pass filter with extremely steep skirts, simultaneously exhibiting low loss in the WiFi band and high near-in rejection in the approximate LTE bands.

885128 is specifically designed to enable coexistence of WiFi and LTE signals within the same device or in close proximity to one another.

The 885128 uses common module packaging techniques to achieve the industry leading size 1.1 x 0.9 x 0.50 mm footprint. The filter exhibits excellent power handling capabilities.

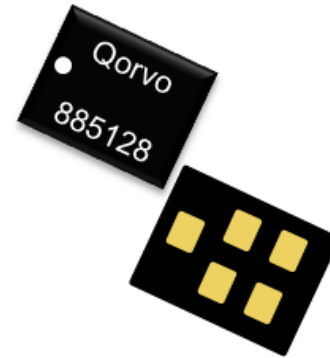

1.1 X 0.9 X 0.50 mm

### Functional Block Diagram

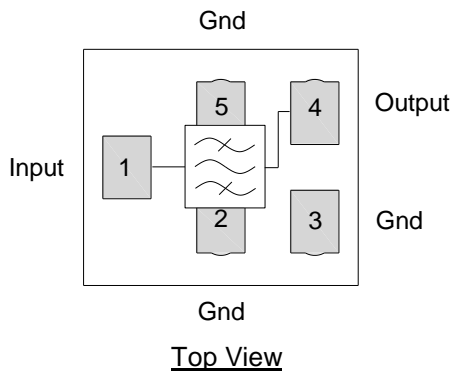

### Pin Configuration - Single Ended

Pin No.	Label
1	Input
4	Output
2,3,5	Function label

**Note:**

- Pin 1 must be used for input. The large signal performance of this filter (power handling and nonlinear response) is not symmetric

### Product Features

- Low Loss in WLAN band with extended upper corner for inclusion of Bluetooth
- High Rejection in B30/B38/B7/B41 bands
- Industry leading small size: 1.1 x 0.9 x 0.5 mm
- Performance over -40 to +95 °C
- Single Ended operation
- RoHS compliant, Pb-free module package

### Applications

- WiFi bandpass filter that enables the coexistence of (LTE/TD-LTE) & Wi-Fi
- Portable Hotspots
- Wi-Fi Routers and LTE Gateways
- Smart Meters
- Wi-Fi Access Points
- Small Cells

### Ordering Information

Part No.	Description
885128	Packaged Part
885128-EVB	Evaluation board

Standard T/R size = 15,000 units/reel

## Absolute Maximum Ratings <sup>(1)</sup>

Parameter	Rating
Storage Temperature	-40°C to 125°C
Operating Temperature	-40°C to +105°C
RF Input Power <sup>(2)</sup>	+36 dBm

**Notes:**

1. Operation of this device outside the parameter ranges given may cause permanent damage.
2. Max CW signal applied for up to 500ms with no damage. Pin 1 must be used for input. The large signal performance of this filter (power handling and nonlinear response) is not symmetric.

## Electrical Specifications <sup>(1)</sup>

 Test conditions unless otherwise noted: <sup>(2)</sup> -30 °C to +85 °C

Parameter <sup>(3)</sup>	Conditions	Min	Typ <sup>(5)</sup>	Max	Units
Insertion Loss <sup>(6)</sup>	2402.5 – 2421.5 MHz (WiFi Ch.1)	-	1.5	1.7	dB
	2407.5 – 2426.5 MHz (WiFi Ch.2)	-	1.3	1.5	
	2412.5 – 2471.5 MHz (WiFi Ch.3-11)	-	1.1	1.4	
	2412.5 – 2471.5 MHz (WiFi Ch.3-11)(19 MHz sliding window)	-	1.3	1.5	
	2457.5 – 2476.5 MHz (WiFi Ch.12)	-	1.3	1.6	
	2462.5 – 2481.5 MHz (WiFi Ch.13)	-	1.5	1.9	
Amplitude Variation	2402.5 – 2421.5 MHz (WiFi Ch.1)	-	0.9	1.4	dB p-p
	2407.5 – 2426.5 MHz (WiFi Ch.2)	-	0.7	0.9	
	2412.5 – 2471.5 MHz (WiFi Ch.3-11)	-	0.7	1.1	
	2457.5 – 2476.5 MHz (WiFi Ch.12)	-	0.5	1.2	
	2462.5 – 2481.5 MHz (WiFi Ch.13)	-	0.9	2.0	
Rejection	925 – 960 MHz	32	33	-	dB
	1559 – 1606 MHz	32	33	-	
	2110 – 2170 MHz	42	47	-	
	2300 – 2370 MHz <sup>(7)</sup>	33	39	-	
	2500 – 2505 MHz (+25 to +85°C) <sup>(7)</sup>	31	38	-	
	2500 – 2505 MHz (-30 to +25°C) <sup>(7)</sup>	23	38	-	
	2505 – 2570 MHz (+25 to +85°C) <sup>(7)</sup>	44	50	-	
	2505 – 2570 MHz (-30 to +25°C) <sup>(7)</sup>	41	50	-	
	2570 – 2620 MHz <sup>(7)</sup>	47	50	-	
	2620 – 2690 MHz <sup>(7)</sup>	45	49	-	
	4800 – 5000 MHz	27	33	-	
7200 – 7500 MHz	27	31	-		
Input /Output VSWR	2402.5 – 2481.5 MHz	-	1.6	2.0	-
RF Input Power <sup>(8)</sup>	2400 – 2483 MHz	-	24	-	dBm
Source Impedance <sup>(9)</sup>	(single-ended)	-	50	-	Ω
Load Impedance <sup>(9)</sup>	(single-ended)	-	50	-	Ω

**Notes:**

1. All specifications are based on the Qorvo schematic shown on page 5.
2. In production, devices will be tested at room temperature to a guardbanded specification to ensure electrical compliance over temperature.
3. Electrical margin has been built into the design to account for the variations due to temperature drift and manufacturing tolerances.
4. An external impedance matching network with ±2 % tolerance will be necessary to achieve the stated specifications.
5. Typical values are based on average measurements at room temperature.
6. Data is the integrated value of the linear s-parameter over a 19 MHz range in the indicated band at the specified temperature.
7. Data is the integrated value of the linear s-parameter over 5MHz range at the specified temperature.
8. Input power applied for a minimum of 5,000 hrs. at 55 °C in the frequency band specified.
9. This is the optimum impedance in order to achieve the performance shown.

## Electrical Specifications <sup>(1)</sup>

Test conditions unless otherwise noted: <sup>(2)</sup> -40 °C to +95 °C

Parameter <sup>(3)</sup>	Conditions	Min	Typ <sup>(5)</sup>	Max	Units
Insertion Loss <sup>(6)</sup>	2402.5 – 2421.5 MHz (WiFi Ch.1)	-	1.5	1.7	dB
	2407.5 – 2426.5 MHz (WiFi Ch.2)	-	1.3	1.5	
	2412.5 – 2471.5 MHz (WiFi Ch.3-11)	-	1.1	1.3	
	2412.5 – 2471.5 MHz (WiFi Ch.3-11)(19 MHz sliding window)	-	1.3	1.6	
	2457.5 – 2476.5 MHz (WiFi Ch.12)	-	1.3	1.7	
	2462.5 – 2481.5 MHz (WiFi Ch.13)	-	1.5	2.0	
Amplitude Variation	2402.5 – 2421.5 MHz (WiFi Ch.1)	-	0.9	1.5	dB p-p
	2407.5 – 2426.5 MHz (WiFi Ch.2)	-	0.7	0.9	
	2412.5 – 2471.5 MHz (WiFi Ch.3-11)	-	0.7	1.1	
	2457.5 – 2476.5 MHz (WiFi Ch.12)	-	0.5	1.2	
	2462.5 – 2481.5 MHz (WiFi Ch.13)	-	0.9	2.1	
Rejection	925 – 960 MHz	32	33	-	dB
	1559 – 1606 MHz	32	33	-	
	2110 – 2170 MHz	42	47	-	
	2300 – 2370 MHz <sup>(7)</sup>	33	39	-	
	2500 – 2505 MHz (+25 to +95 °C) <sup>(7)</sup>	31	38	-	
	2500 – 2505 MHz (-40 to +25 °C) <sup>(7)</sup>	22	38	-	
	2505 – 2570 MHz (+25 to +95 °C) <sup>(7)</sup>	44	50	-	
	2505 – 2570 MHz (-40 to +25 °C) <sup>(7)</sup>	39	50	-	
	2570 – 2620 MHz <sup>(7)</sup>	47	50	-	
	2620 – 2690 MHz <sup>(7)</sup>	45	49	-	
4800 – 5000 MHz	27	33	-		
7200 – 7500 MHz	27	31	-		
Input /Output VSWR	2402.5 – 2481.5 MHz	-	1.6	2.0	-
RF Input Power <sup>(8)</sup>	2400 – 2483 MHz	-	24	-	dBm
Source Impedance <sup>(9)</sup>	(single-ended)	-	50	-	Ω
Load Impedance <sup>(9)</sup>	(single-ended)	-	50	-	Ω

### Notes:

- All specifications are based on the Qorvo schematic shown on page 5.
- In production, devices will be tested at room temperature to a guardbanded specification to ensure electrical compliance over temperature.
- Electrical margin has been built into the design to account for the variations due to temperature drift and manufacturing tolerances.
- An external impedance matching network with  $\pm 2\%$  tolerance will be necessary to achieve the stated specifications.
- Typical values are based on average measurements at room temperature.
- Data is the integrated value of the linear s-parameter over a 19 MHz range in the indicated band at the specified temperature.
- Data is the integrated value of the linear s-parameter over 5MHz range at the specified temperature.
- Input power applied for a minimum of 5,000 hrs. at 55 °C in the frequency band specified.
- This is the optimum impedance in order to achieve the performance shown.

## Electrical Specifications <sup>(1)</sup>

Test conditions unless otherwise noted: <sup>(2)</sup> 0 °C to +70 °C

Parameter <sup>(3)</sup>	Conditions	Min	Typ <sup>(5)</sup>	Max	Units
Insertion Loss <sup>(6)</sup>	2402.5 – 2421.5 MHz (WiFi Ch.1)	-	1.5	1.6	dB
	2407.5 – 2426.5 MHz (WiFi Ch.2)	-	1.3	1.3	
	2412.5 – 2471.5 MHz (WiFi Ch.3-11)	-	1.1	1.2	
	2412.5 – 2471.5 MHz (WiFi Ch.3-11)(19 MHz sliding window)	-	1.3	1.3	
	2457.5 – 2476.5 MHz (WiFi Ch.12)	-	1.3	1.6	
	2462.5 – 2481.5 MHz (WiFi Ch.13)	-	1.5	1.7	
Amplitude Variation	2402.5 – 2421.5 MHz (WiFi Ch.1)	-	0.9	1.2	dB p-p
	2407.5 – 2426.5 MHz (WiFi Ch.2)	-	0.7	0.9	
	2412.5 – 2471.5 MHz (WiFi Ch.3-11)	-	0.7	0.9	
	2457.5 – 2476.5 MHz (WiFi Ch.12)	-	0.5	0.9	
	2462.5 – 2481.5 MHz (WiFi Ch.13)	-	0.9	1.6	
Rejection	925 – 960 MHz	32	33	-	dB
	1559 – 1606 MHz	32	33	-	
	2110 – 2170 MHz	43	47	-	
	2300 – 2370 MHz <sup>(7)</sup>	33	39	-	
	2500 – 2505 MHz (+25 to +70 °C) <sup>(7)</sup>	31	38	-	
	2500 – 2505 MHz ( 0 to +25 °C) <sup>(7)</sup>	26	38	-	
	2505 – 2570 MHz (+25 to +70 °C) <sup>(7)</sup>	44	50	-	
	2505 – 2570 MHz ( 0 to +25 °C) <sup>(7)</sup>	44	50	-	
	2570 – 2620 MHz <sup>(7)</sup>	47	50	-	
	2620 – 2690 MHz <sup>(7)</sup>	46	49	-	
	4800 – 5000 MHz	27	33	-	
7200 – 7500 MHz	27	31	-		
Input /Output VSWR	2402.5 – 2481.5 MHz	-	1.6	1.9	-
RF Input Power <sup>(8)</sup>	2400 – 2483 MHz	-	24	-	dBm
Source Impedance <sup>(9)</sup>	(single-ended)	-	50	-	Ω
Load Impedance <sup>(9)</sup>	(single-ended)	-	50	-	Ω

**Notes:**

1. All specifications are based on the Qorvo schematic shown on page 5.
2. In production, devices will be tested at room temperature to a guardbanded specification to ensure electrical compliance over temperature.
3. Electrical margin has been built into the design to account for the variations due to temperature drift and manufacturing tolerances.
4. An external impedance matching network with ±2 % tolerance will be necessary to achieve the stated specifications.
5. Typical values are based on average measurements at room temperature.
6. Data is the integrated value of the linear s-parameter over a 19 MHz range in the indicated band at the specified temperature.
7. Data is the integrated value of the linear s-parameter over 5MHz range at the specified temperature.
8. Input power applied for a minimum of 5,000 hrs. at 55 °C in the frequency band specified.
9. This is the optimum impedance in order to achieve the performance shown.

### Evaluation Board – 885128-EVB

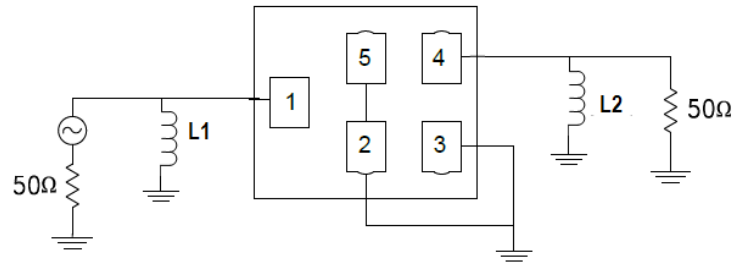
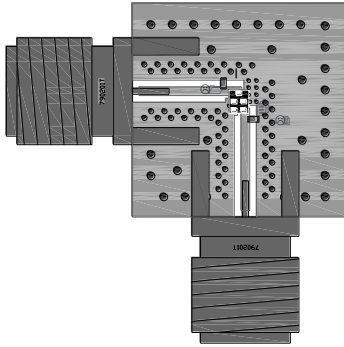

- Notes:
1. Matching component values shown are for the specified TriQuint evaluation board. Value adjustment may be required in end user product circuits depending on component manufacturer and PCB material.
  2. PCB: .500 x .500 x .062; Construction: ½ oz Cu Top Layer; TLY-5A (.0075) ½ oz Cu Middle Layer, FR4; ½ oz Cu Bottom Layer. (dimensions are in inches)

### Bill of Material – 885128-EVB

Reference Des.	Value	Description	Manuf.	Part Number
U1	N/A	2.4 GHz WLAN/BT filter	Qorvo	885128
L1	10 nH	Chip Inductor, 0201, ± 2 %	Murata	LQP03TH10NH02D
L2	10 nH	Chip Inductor, 0201, ± 2 %	Murata	LQP03TH10NH02D
SMA	N/A	SMA connector	Radiall	9602-1111-018
PCB	N/A	3 Layer	Multiple	961094-04

### PCB Mounting Pattern

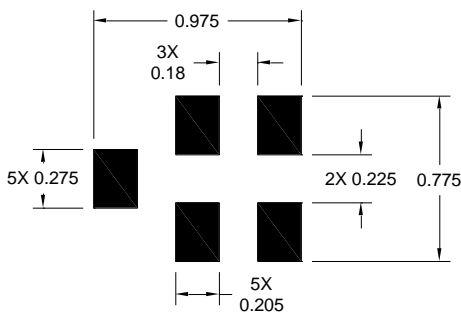

- Notes:
1. All dimensions are in millimeters. Angles are in degrees.
  2. This drawing specifies the mounting pattern used on the Qorvo evaluation board for this product. Some modification may be necessary to suit end user assembly materials and processes.

### Performance Plots

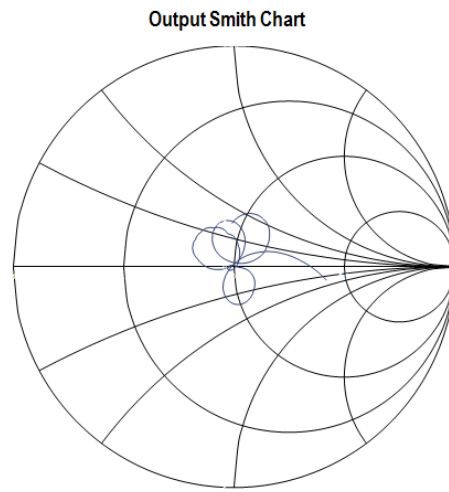
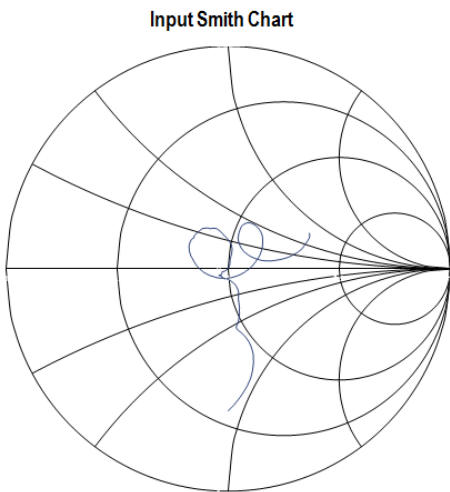
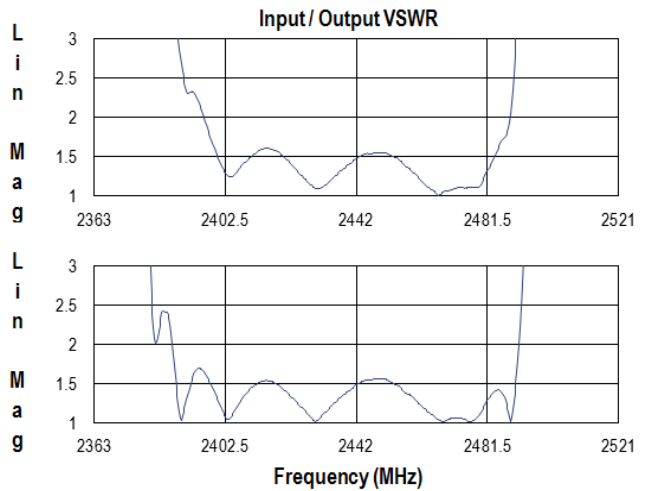
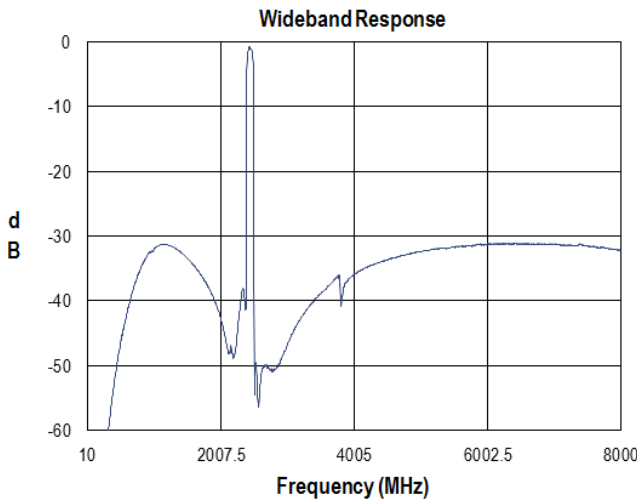
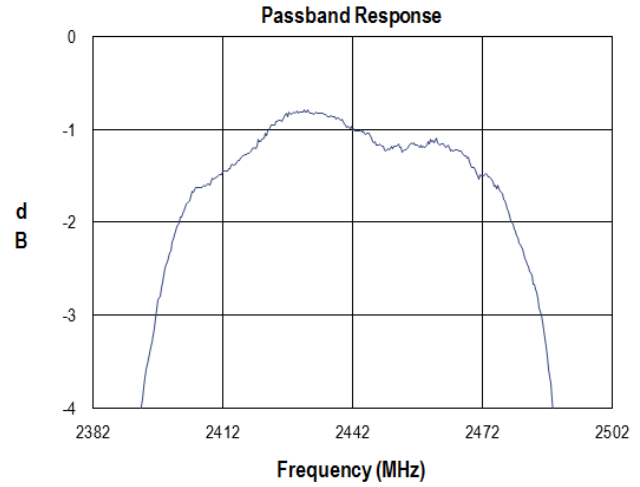
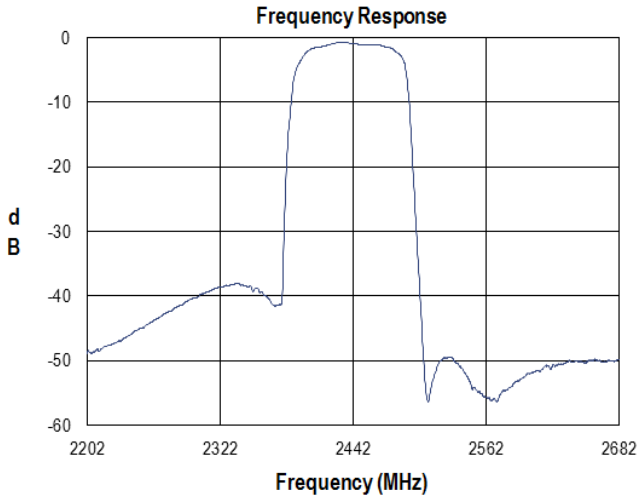

Package Information, Marking and Dimensions

Package Style: ULC1109A  
 Dimensions: 1.1 x 0.9 x 0.50 mm

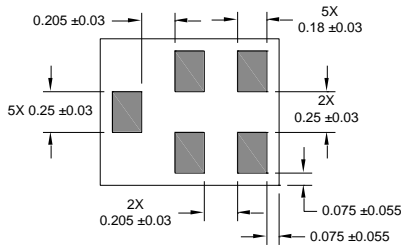
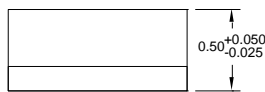
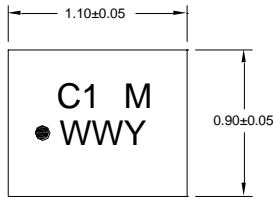

Package for Surface Mount Technology  
 Terminations: Au plating 0.5 - 1.0 μm, over a 2-6 μm Ni Plating  
 Approximate weight 3.96 mg

All dimensions shown are nominal in millimeters. Unless otherwise specified all tolerances are ±0.05mm except length and width that are specified as ±0.1mm

The Marking Code is correlated with the Part Number  
 M=Manufacturing Site Code (Blank for Apopka, C for Costa Rica)  
 The Date Code consists of:  
 WW = 2 digit week  
 Y=The last digit of the year

- Notes:
1. All dimensions shown are typical in millimeters
  2. An asterisk (\*) in front of the marking code indicates prototype.

Tape and Reel information

Standard T/R size = 15,000 units/reel. All dimensions are in millimeters

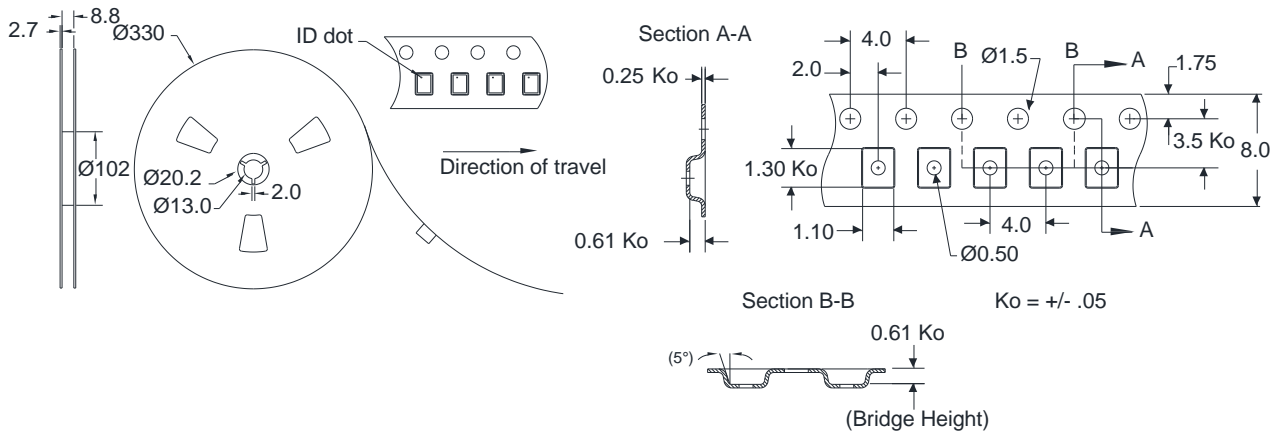

## Handling Precautions

Parameter	Rating	Standard
ESD – Human Body Model (HBM)	Class 1C	ESDA / JEDEC JS-001
ESD – Charge Device Model (CDM)	Class C3	ESDA / JEDEC JES-002
MSL-Moisture Sensitivity Level	Level 3	JEDEC Standard IPC/JEDEC J-STD-020



Caution!  
ESD-Sensitive Device

## Solderability

Compatible with both lead-free (260°C max. reflow temp.) and tin/lead (245°C max. reflow temp.) soldering processes. Solder profiles available upon request.

## RoHS Compliance

This part is compliant with 2011/65/EU RoHS directive (Restrictions on the Use of Certain Hazardous Substances in Electrical and Electronic Equipment) as amended by Directive 2015/863/EU. This product also has the following attributes:

- Lead Free
- Halogen Free (Chlorine, Bromine)
- Antimony Free
- TBBP-A (C<sub>15</sub>H<sub>12</sub>Br<sub>4</sub>O<sub>2</sub>) Free
- PFOS Free
- SVHC Free
- Qorvo Green



## Contact Information

For the latest specifications, additional product information, worldwide sales and distribution locations:

Web: [www.qorvo.com](http://www.qorvo.com)

Tel: 1-844-890-8163

Email: [customer.support@qorvo.com](mailto:customer.support@qorvo.com)

For technical questions and application information: Email: [flapplication.engineering@qorvo.com](mailto:flapplication.engineering@qorvo.com)

## Important Notice

The information contained herein is believed to be reliable; however, Qorvo makes no warranties regarding the information contained herein and assumes no responsibility or liability whatsoever for the use of the information contained herein. All information contained herein is subject to change without notice. Customers should obtain and verify the latest relevant information before placing orders for Qorvo products. The information contained herein or any use of such information does not grant, explicitly or implicitly, to any party any patent rights, licenses, or any other intellectual property rights, whether with regard to such information itself or anything described by such information. **THIS INFORMATION DOES NOT CONSTITUTE A WARRANTY WITH RESPECT TO THE PRODUCTS DESCRIBED HEREIN, AND QORVO HEREBY DISCLAIMS ANY AND ALL WARRANTIES WITH RESPECT TO SUCH PRODUCTS WHETHER EXPRESS OR IMPLIED BY LAW, COURSE OF DEALING, COURSE OF PERFORMANCE, USAGE OF TRADE OR OTHERWISE, INCLUDING THE IMPLIED WARRANTIES OF MERCHANTABILITY AND FITNESS FOR A PARTICULAR PURPOSE.**

Without limiting the generality of the foregoing, Qorvo products are not warranted or authorized for use as critical components in medical, life-saving, or life-sustaining applications, or other applications where a failure would reasonably be expected to cause severe personal injury or death.

Copyright 2016 © Qorvo, Inc. | Qorvo is a registered trademark of Qorvo, Inc.



# Mouser Electronics

Authorized Distributor

Click to View Pricing, Inventory, Delivery & Lifecycle Information:

[Qorvo:](#)

[885128](#)