

ISL9V3040D3S / ISL9V3040S3S / ISL9V3040P3 / ISL9V3040S3

EcoSPARK[®] 300mJ, 400V, N-Channel Ignition IGBT

General Description

The ISL9V3040D3S, ISL9V3040S3S, ISL9V3040P3, and ISL9V3040S3 are the next generation ignition IGBTs that offer outstanding SCIS capability in the space saving D-Pak (TO-252), as well as the industry standard D²-Pak (TO-263), and TO-262 and TO-220 plastic packages. This device is intended for use in automotive ignition circuits, specifically as a coil driver. Internal diodes provide voltage clamping without the need for external components.

EcoSPARK[®] devices can be custom made to specific clamp voltages. Contact your nearest Fairchild sales office for more information.

Formerly Developmental Type 49362

Applications

- Automotive Ignition Coil Driver Circuits
- Coil- On Plug Applications

Features

- Space saving D-Pak package availability
- SCIS Energy = 300mJ at T_J = 25°C
- Logic Level Gate Drive

Package

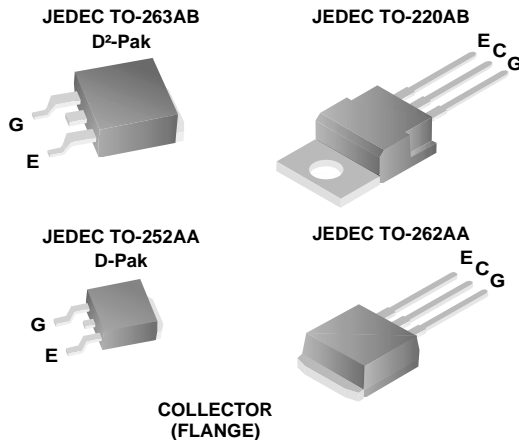

Symbol

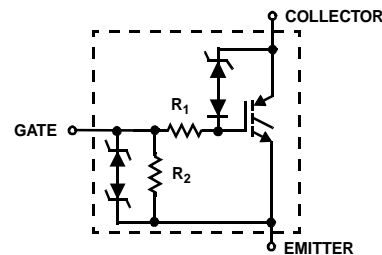

Device Maximum Ratings T_A = 25°C unless otherwise noted

| Symbol | Parameter | Ratings | Units |
|----------------------|-----------------------------------------------------------------------------------|------------|-------|
| BV _{CER} | Collector to Emitter Breakdown Voltage (I _C = 1 mA) | 430 | V |
| BV _{ECS} | Emitter to Collector Voltage - Reverse Battery Condition (I _C = 10 mA) | 24 | V |
| E _{SCIS25} | At Starting T _J = 25°C, I _{SCIS} = 14.2A, L = 3.0 mHy | 300 | mJ |
| E _{SCIS150} | At Starting T _J = 150°C, I _{SCIS} = 10.6A, L = 3.0 mHy | 170 | mJ |
| I _{C25} | Collector Current Continuous, At T _C = 25°C, See Fig 9 | 21 | A |
| I _{C110} | Collector Current Continuous, At T _C = 110°C, See Fig 9 | 17 | A |
| V _{GEM} | Gate to Emitter Voltage Continuous | ±10 | V |
| P _D | Power Dissipation Total T _C = 25°C | 150 | W |
| | Power Dissipation Derating T _C > 25°C | 1.0 | W/°C |
| T _J | Operating Junction Temperature Range | -40 to 175 | °C |
| T _{STG} | Storage Junction Temperature Range | -40 to 175 | °C |
| T _L | Max Lead Temp for Soldering (Leads at 1.6mm from Case for 10s) | 300 | °C |
| T _{pkg} | Max Lead Temp for Soldering (Package Body for 10s) | 260 | °C |
| ESD | Electrostatic Discharge Voltage at 100pF, 1500Ω | 4 | kV |

Package Marking and Ordering Information

| Device Marking | Device | Package | Reel Size | Tape Width | Quantity |
|----------------|---------------|----------|-----------|------------|----------|
| V3040D | ISL9V3040D3ST | TO-252AA | 330mm | 16mm | 2500 |
| V3040S | ISL9V3040S3ST | TO-263AB | 330mm | 24mm | 800 |
| V3040P | ISL9V3040P3 | TO-220AA | Tube | N/A | 50 |
| V3040S | ISL9V3040S3 | TO-262AA | Tube | N/A | 50 |
| V3040D | ISL9V3040D3S | TO-252AA | Tube | N/A | 75 |
| V3040S | ISL9V3040S3S | TO-263AB | Tube | N/A | 50 |

Electrical Characteristics $T_A = 25^\circ\text{C}$ unless otherwise noted

| Symbol | Parameter | Test Conditions | Min | Typ | Max | Units |
|--------|-----------|-----------------|-----|-----|-----|-------|
|--------|-----------|-----------------|-----|-----|-----|-------|

Off State Characteristics

| | | | | | | | |
|------------|----------------------------------------|--------------------------------------------------------------------------------------------------------------------|---------------------------|----------|-----|----------|---------------|
| BV_{CER} | Collector to Emitter Breakdown Voltage | $I_C = 2\text{mA}$, $V_{GE} = 0$, $R_G = 1\text{K}\Omega$, See Fig. 15 $T_J = -40$ to 150°C | 370 | 400 | 430 | V | |
| BV_{CES} | Collector to Emitter Breakdown Voltage | $I_C = 10\text{mA}$, $V_{GE} = 0$, $R_G = 0$, See Fig. 15 $T_J = -40$ to 150°C | 390 | 420 | 450 | V | |
| BV_{ECS} | Emitter to Collector Breakdown Voltage | $I_C = -75\text{mA}$, $V_{GE} = 0\text{V}$, $T_C = 25^\circ\text{C}$ | 30 | - | - | V | |
| BV_{GES} | Gate to Emitter Breakdown Voltage | $I_{GES} = \pm 2\text{mA}$ | ± 12 | ± 14 | - | V | |
| I_{CER} | Collector to Emitter Leakage Current | $V_{CER} = 250\text{V}$, $R_G = 1\text{K}\Omega$, See Fig. 11 | $T_C = 25^\circ\text{C}$ | - | - | 25 | μA |
| | | | $T_C = 150^\circ\text{C}$ | - | - | 1 | mA |
| I_{ECS} | Emitter to Collector Leakage Current | $V_{EC} = 24\text{V}$, See Fig. 11 | $T_C = 25^\circ\text{C}$ | - | - | 1 | mA |
| | | | $T_C = 150^\circ\text{C}$ | - | - | 40 | mA |
| R_1 | Series Gate Resistance | | - | 70 | - | Ω | |
| R_2 | Gate to Emitter Resistance | | 10K | - | 26K | Ω | |

On State Characteristics

| | | | | | | | |
|---------------|-----------------------------------------|------------------------------------------------|-------------------------------------------|---|------|------|---|
| $V_{CE(SAT)}$ | Collector to Emitter Saturation Voltage | $I_C = 6\text{A}$, $V_{GE} = 4\text{V}$ | $T_C = 25^\circ\text{C}$, See Fig. 3 | - | 1.25 | 1.60 | V |
| $V_{CE(SAT)}$ | Collector to Emitter Saturation Voltage | $I_C = 10\text{A}$, $V_{GE} = 4.5\text{V}$ | $T_C = 150^\circ\text{C}$, See Fig. 4 | - | 1.58 | 1.80 | V |
| $V_{CE(SAT)}$ | Collector to Emitter Saturation Voltage | $I_C = 15\text{A}$, $V_{GE} = 4.5\text{V}$ | $T_C = 150^\circ\text{C}$ | - | 1.90 | 2.20 | V |

Dynamic Characteristics

| | | | | | | | |
|--------------|-----------------------------------|------------------------------------------------------------------------------------|---------------------------|------|---|-------------|---|
| $Q_{G(ON)}$ | Gate Charge | $I_C = 10\text{A}$, $V_{CE} = 12\text{V}$, $V_{GE} = 5\text{V}$, See Fig. 14 | - | 17 | - | nC | |
| $V_{GE(TH)}$ | Gate to Emitter Threshold Voltage | $I_C = 1.0\text{mA}$, $V_{CE} = V_{GE}$, See Fig. 10 | $T_C = 25^\circ\text{C}$ | 1.3 | - | 2.2 | V |
| | | | $T_C = 150^\circ\text{C}$ | 0.75 | - | 1.8 | V |
| V_{GEP} | Gate to Emitter Plateau Voltage | $I_C = 10\text{A}$, $V_{CE} = 12\text{V}$ | - | 3.0 | - | V | |

Switching Characteristics

| | | | | | | |
|---------------|---------------------------------------|-----------------------------------------------------------------------------------------------------------------------------------------------|---|-----|-----|---------------|
| $t_{d(ON)R}$ | Current Turn-On Delay Time-Resistive | $V_{CE} = 14\text{V}$, $R_L = 1\Omega$, $V_{GE} = 5\text{V}$, $R_G = 1\text{K}\Omega$, $T_J = 25^\circ\text{C}$, See Fig. 12 | - | 0.7 | 4 | μs |
| t_{rR} | Current Rise Time-Resistive | | - | 2.1 | 7 | μs |
| $t_{d(OFF)L}$ | Current Turn-Off Delay Time-Inductive | $V_{CE} = 300\text{V}$, $L = 500\mu\text{H}$, $V_{GE} = 5\text{V}$, $R_G = 1\text{K}\Omega$, $T_J = 25^\circ\text{C}$, See Fig. 12 | - | 4.8 | 15 | μs |
| t_{fL} | Current Fall Time-Inductive | | - | 2.8 | 15 | μs |
| SCIS | Self Clamped Inductive Switching | $T_J = 25^\circ\text{C}$, $L = 3.0\text{mH}$, $R_G = 1\text{K}\Omega$, $V_{GE} = 5\text{V}$, See Fig. 1 & 2 | - | - | 300 | mJ |

Thermal Characteristics

| | | | | | | |
|-----------------|----------------------------------|--------------|---|---|-----|--------------------|
| $R_{\theta JC}$ | Thermal Resistance Junction-Case | All packages | - | - | 1.0 | $^\circ\text{C/W}$ |
|-----------------|----------------------------------|--------------|---|---|-----|--------------------|

Typical Performance Curves

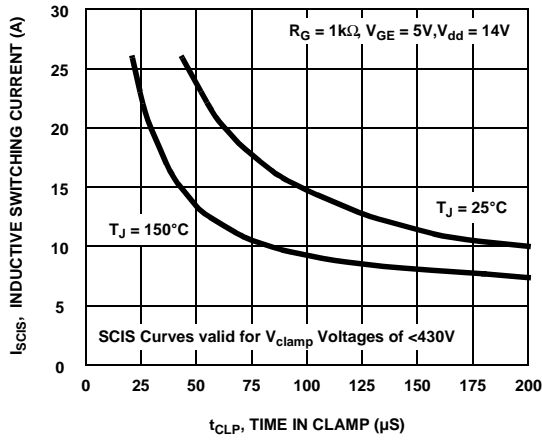

Figure 1. Self Clamped Inductive Switching Current vs Time in Clamp

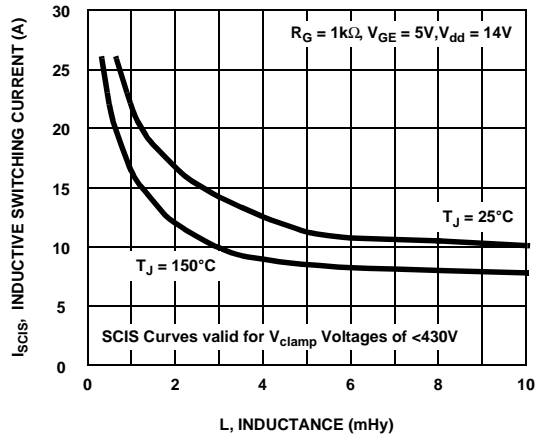

Figure 2. Self Clamped Inductive Switching Current vs Inductance

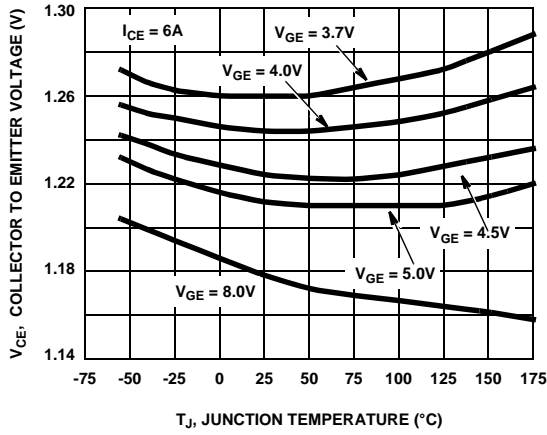

Figure 3. Collector to Emitter On-State Voltage vs Junction Temperature

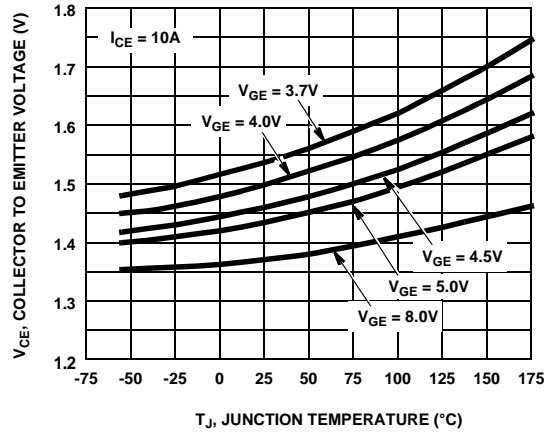

Figure 4. Collector to Emitter On-State Voltage vs Junction Temperature

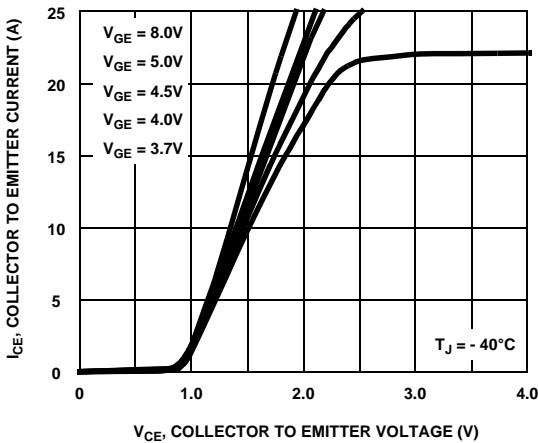

Figure 5. Collector to Emitter On-State Voltage vs Collector Current

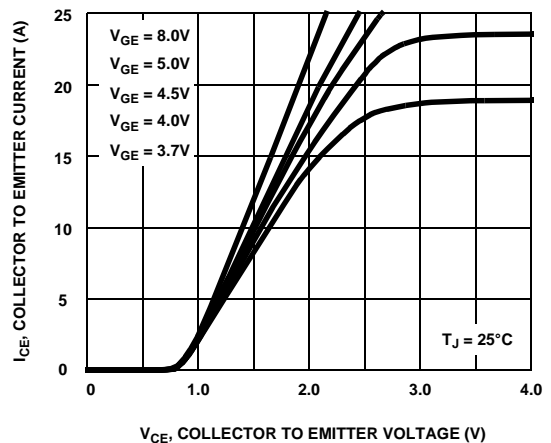

Figure 6. Collector to Emitter On-State Voltage vs Collector Current

Typical Performance Curves (Continued)

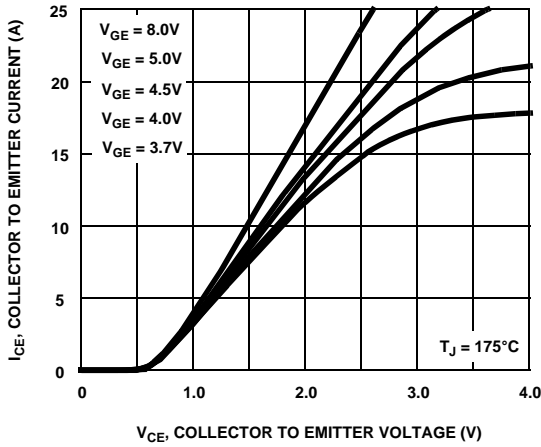

Figure 7. Collector to Emitter On-State Voltage vs Collector Current

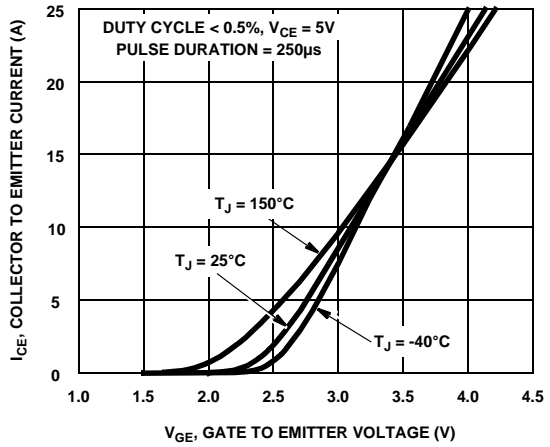

Figure 8. Transfer Characteristics

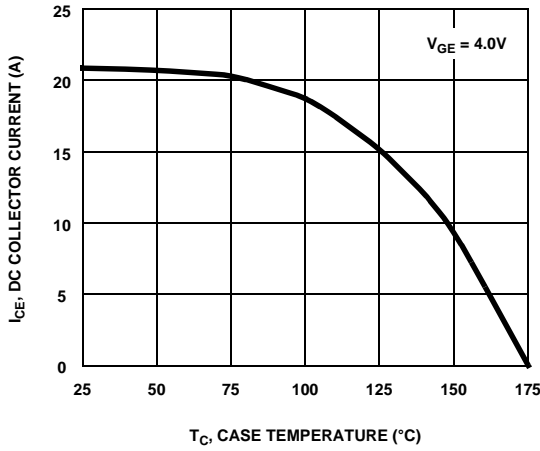

Figure 9. DC Collector Current vs Case Temperature

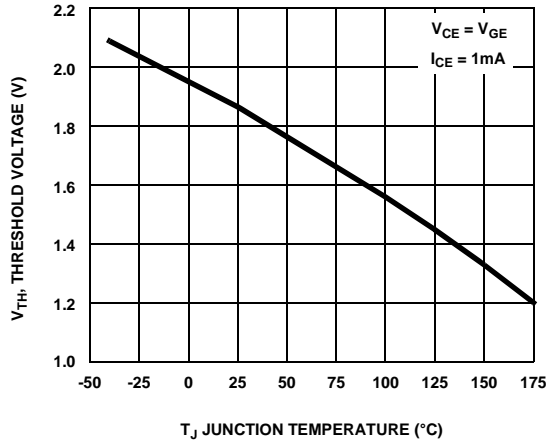

Figure 10. Threshold Voltage vs Junction Temperature

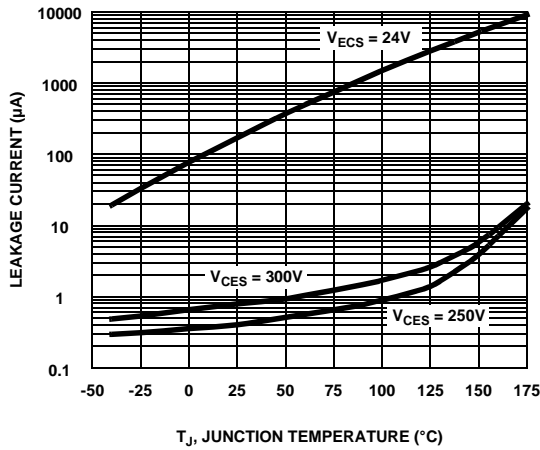

Figure 11. Leakage Current vs Junction Temperature

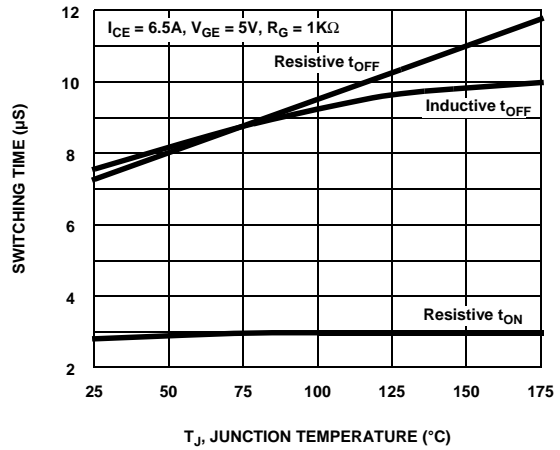

Figure 12. Switching Time vs Junction Temperature

Typical Performance Curves (Continued)

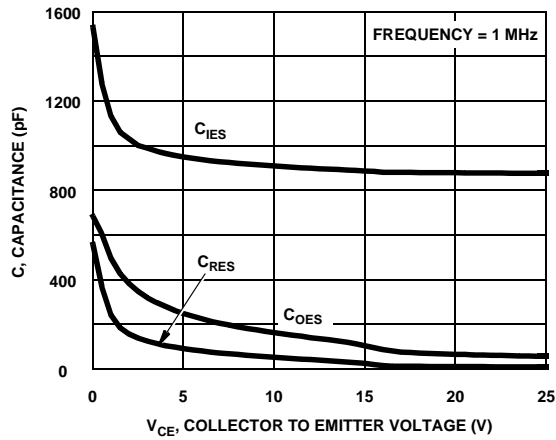

Figure 13. Capacitance vs Collector to Emitter Voltage

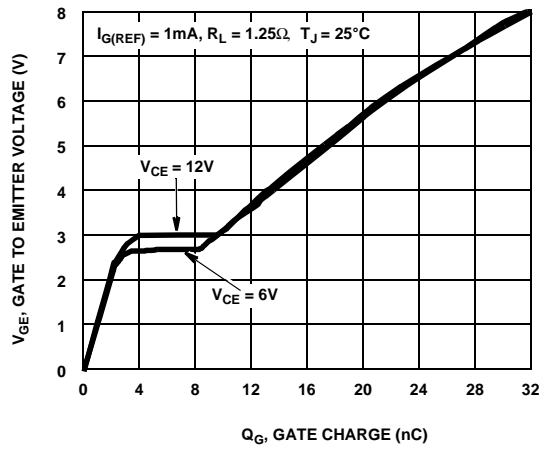

Figure 14. Gate Charge

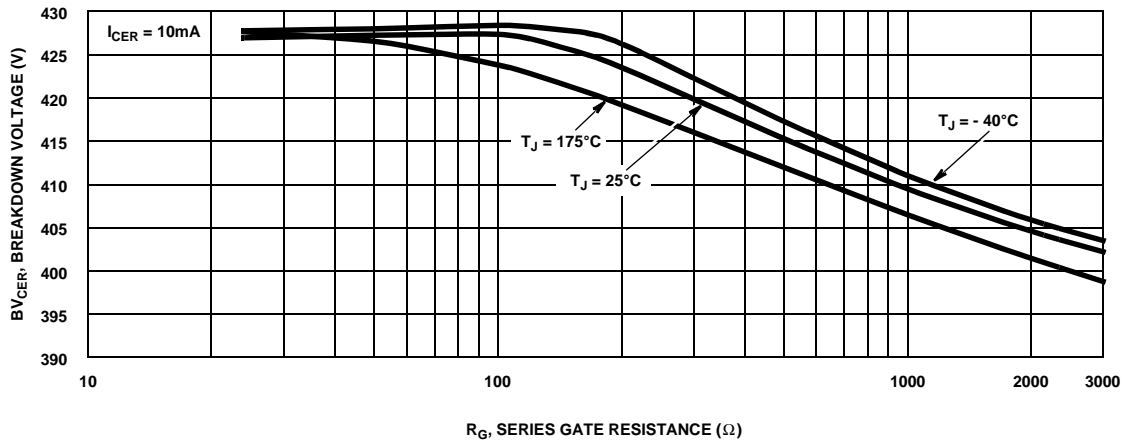

Figure 15. Breakdown Voltage vs Series Gate Resistance

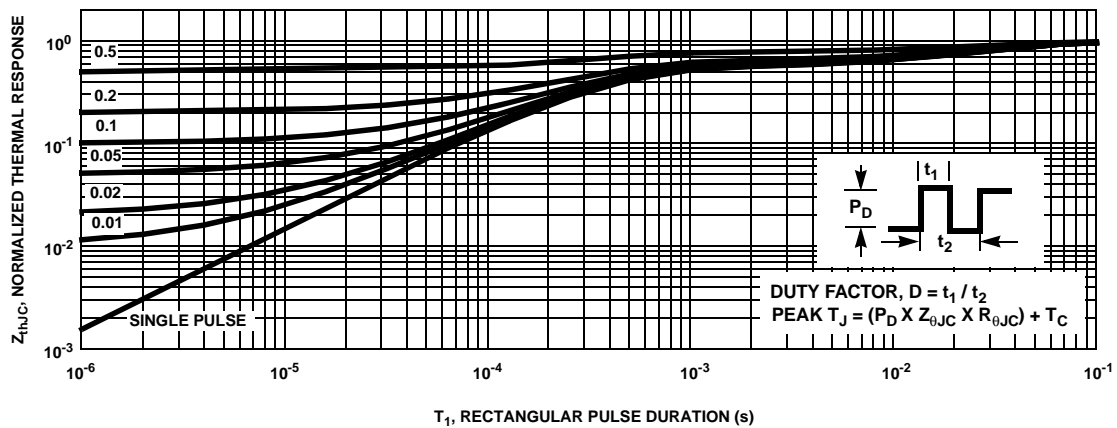

Figure 16. IGBT Normalized Transient Thermal Impedance, Junction to Case

Test Circuit and Waveforms

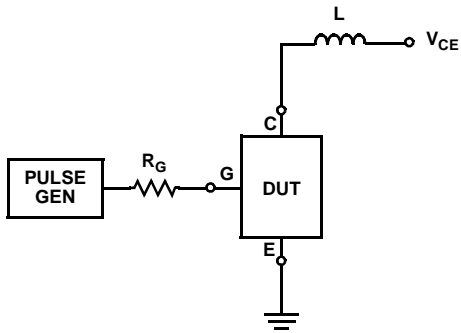

Figure 17. Inductive Switching Test Circuit

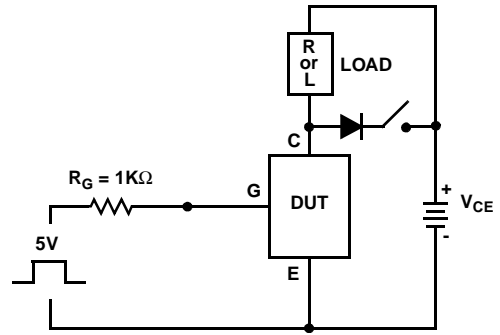

Figure 18. t_{ON} and t_{OFF} Switching Test Circuit

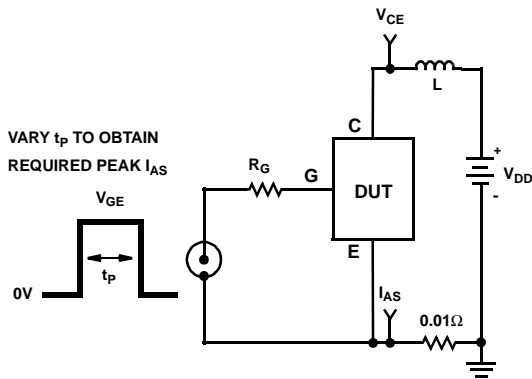

Figure 19. Energy Test Circuit

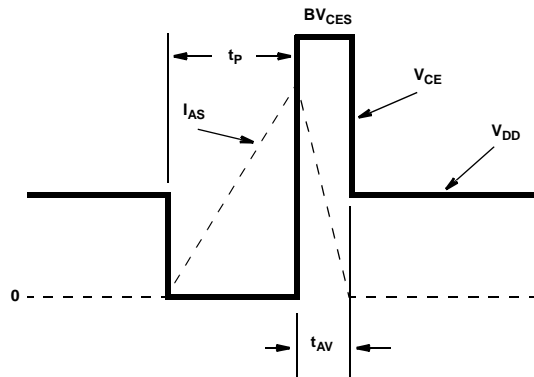

Figure 20. Energy Waveforms

SPICE Thermal Model

REV 7 March 2002

ISL9V3040D3S / ISL9V3040S3S / ISL9V3040P3 /
ISL9V3040S3

```
CTHERM1 th 6 2.1e -3  
CTHERM2 6 5 1.4e -1  
CTHERM3 5 4 7.3e -3  
CTHERM4 4 3 2.1e -1  
CTHERM5 3 2 1.1e -1  
CTHERM6 2 tl 6.2e +6
```

```
RTHERM1 th 6 1.2e -1  
RTHERM2 6 5 1.9e -1  
RTHERM3 5 4 2.2e -1  
RTHERM4 4 3 6.0e -2  
RTHERM5 3 2 5.8e -2  
RTHERM6 2 tl 1.6e -3
```

SABER Thermal Model

SABER thermal model
ISL9V3040D3S / ISL9V3040S3S / ISL9V3040P3 /
ISL9V3040S3

```
template thermal_model th tl  
thermal_c th, tl
```

```
{  
  ctherm.ctherm1 th 6 = 2.1e -3  
  ctherm.ctherm2 6 5 = 1.4e -1  
  ctherm.ctherm3 5 4 = 7.3e -3  
  ctherm.ctherm4 4 3 = 2.2e -1  
  ctherm.ctherm5 3 2 = 1.1e -1  
  ctherm.ctherm6 2 tl = 6.2e +6
```

```
  rtherm.rtherm1 th 6 = 1.2e -1  
  rtherm.rtherm2 6 5 = 1.9e -1  
  rtherm.rtherm3 5 4 = 2.2e -1  
  rtherm.rtherm4 4 3 = 6.0e -2  
  rtherm.rtherm5 3 2 = 5.8e -2  
  rtherm.rtherm6 2 tl = 1.6e -3  
}
```

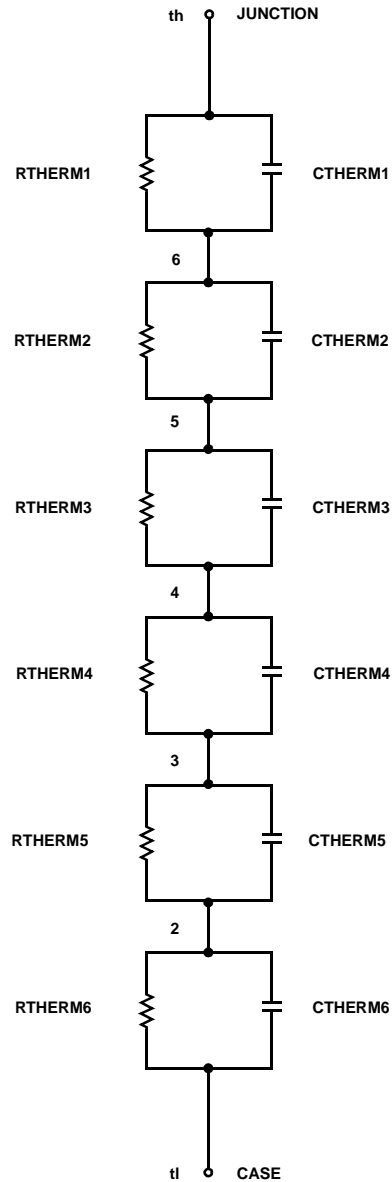





ISL9V3040D3S / ISL9V3040S3S / ISL9V3040P3 / ISL9V3040S3



TRADEMARKS

The following includes registered and unregistered trademarks and service marks, owned by Fairchild Semiconductor and/or its global subsidiaries, and is not intended to be an exhaustive list of all such trademarks.

- | | | | |
|-----------------------------------------------------------------------------------|------------------------------------------------|-----------------------------------------------------------------------------------|-------------------------------------------------------------------------------------|
| AccuPower™ | F-PFS™ |  | Sync-Lock™ |
| AX-CAP®* | FRFET® | PowerXS™ |  |
| BitSiC™ | Global Power Resource™ | Programmable Active Droop™ | TinyBoost® |
| Build it Now™ | GreenBridge™ | QFET® | TinyBuck® |
| CorePLUS™ | Green FPS™ | QS™ | TinyCalc™ |
| CorePOWER™ | Green FPS™ e-Series™ | Quiet Series™ | TinyLogic® |
| CROSSVOLT™ | Gmax™ | RapidConfigure™ | TINYOPTO™ |
| CTL™ | GTO™ |  | TinyPower™ |
| Current Transfer Logic™ | IntelliMAX™ | Saving our world, 1mW/W/kW at a time™ | TinyPWM™ |
| DEUXPEED® | ISOPLANAR™ | SignalWise™ | TinyWire™ |
| Dual Cool™ | Making Small Speakers Sound Louder and Better™ | SmartMax™ | TranSiC™ |
| EcoSPARK® | MegaBuck™ | SMART START™ | TriFault Detect™ |
| EfficientMax™ | MICROCOUPLER™ | Solutions for Your Success™ | TRUECURRENT®* |
| ESBC™ | MicroFET™ | SPM® | μSerDes™ |
|  | MicroPak™ | STEALTH™ |  |
| Fairchild® | MicroPak2™ | SuperFET® | UHC® |
| Fairchild Semiconductor® | MillerDrive™ | SuperSOT™-3 | Ultra FRFET™ |
| FACT Quiet Series™ | MotionMax™ | SuperSOT™-6 | UniFET™ |
| FACT® | mWSaver® | SuperSOT™-8 | VcX™ |
| FAST® | OptoHiT™ | SupreMOS® | VisualMax™ |
| FastvCore™ | OPTOLOGIC® | SyncFET™ | VoltagePlus™ |
| FETBench™ | OPTOPLANAR® | | XS™ |
| FPS™ | | | |

* Trademarks of System General Corporation, used under license by Fairchild Semiconductor.

DISCLAIMER

FAIRCHILD SEMICONDUCTOR RESERVES THE RIGHT TO MAKE CHANGES WITHOUT FURTHER NOTICE TO ANY PRODUCTS HEREIN TO IMPROVE RELIABILITY, FUNCTION, OR DESIGN. FAIRCHILD DOES NOT ASSUME ANY LIABILITY ARISING OUT OF THE APPLICATION OR USE OF ANY PRODUCT OR CIRCUIT DESCRIBED HEREIN; NEITHER DOES IT CONVEY ANY LICENSE UNDER ITS PATENT RIGHTS, NOR THE RIGHTS OF OTHERS. THESE SPECIFICATIONS DO NOT EXPAND THE TERMS OF FAIRCHILD'S WORLDWIDE TERMS AND CONDITIONS, SPECIFICALLY THE WARRANTY THEREIN, WHICH COVERS THESE PRODUCTS.

LIFE SUPPORT POLICY

FAIRCHILD'S PRODUCTS ARE NOT AUTHORIZED FOR USE AS CRITICAL COMPONENTS IN LIFE SUPPORT DEVICES OR SYSTEMS WITHOUT THE EXPRESS WRITTEN APPROVAL OF FAIRCHILD SEMICONDUCTOR CORPORATION.

As used herein:

1. Life support devices or systems are devices or systems which, (a) are intended for surgical implant into the body or (b) support or sustain life, and (c) whose failure to perform when properly used in accordance with instructions for use provided in the labeling, can be reasonably expected to result in a significant injury of the user.
2. A critical component in any component of a life support, device, or system whose failure to perform can be reasonably expected to cause the failure of the life support device or system, or to affect its safety or effectiveness.

ANTI-COUNTERFEITING POLICY

Fairchild Semiconductor Corporation's Anti-Counterfeiting Policy. Fairchild's Anti-Counterfeiting Policy is also stated on our external website, www.fairchildsemi.com, under Sales Support.

Counterfeiting of semiconductor parts is a growing problem in the industry. All manufacturers of semiconductor products are experiencing counterfeiting of their parts. Customers who inadvertently purchase counterfeit parts experience many problems such as loss of brand reputation, substandard performance, failed applications, and increased cost of production and manufacturing delays. Fairchild is taking strong measures to protect ourselves and our customers from the proliferation of counterfeit parts. Fairchild strongly encourages customers to purchase Fairchild parts either directly from Fairchild or from Authorized Fairchild Distributors who are listed by country on our web page cited above. Products customers buy either from Fairchild directly or from Authorized Fairchild Distributors are genuine parts, have full traceability, meet Fairchild's quality standards for handling and storage and provide access to Fairchild's full range of up-to-date technical and product information. Fairchild and our Authorized Distributors will stand behind all warranties and will appropriately address any warranty issues that may arise. Fairchild will not provide any warranty coverage or other assistance for parts bought from Unauthorized Sources. Fairchild is committed to combat this global problem and encourage our customers to do their part in stopping this practice by buying direct or from authorized distributors.

PRODUCT STATUS DEFINITIONS

Definition of Terms

| Datasheet Identification | Product Status | Definition |
|--------------------------|-----------------------|-----------------------------------------------------------------------------------------------------------------------------------------------------------------------------------------------------|
| Advance Information | Formative / In Design | Datasheet contains the design specifications for product development. Specifications may change in any manner without notice. |
| Preliminary | First Production | Datasheet contains preliminary data; supplementary data will be published at a later date. Fairchild Semiconductor reserves the right to make changes at any time without notice to improve design. |
| No Identification Needed | Full Production | Datasheet contains final specifications. Fairchild Semiconductor reserves the right to make changes at any time without notice to improve the design. |
| Obsolete | Not In Production | Datasheet contains specifications on a product that is discontinued by Fairchild Semiconductor. The datasheet is for reference information only. |

Rev. I66