

Amphenol®/Pyle®

● LMD & LMS Connectors

LM-300-1

**Linear Modular Connectors
for Instrumentation and
Avionic Control Environments**

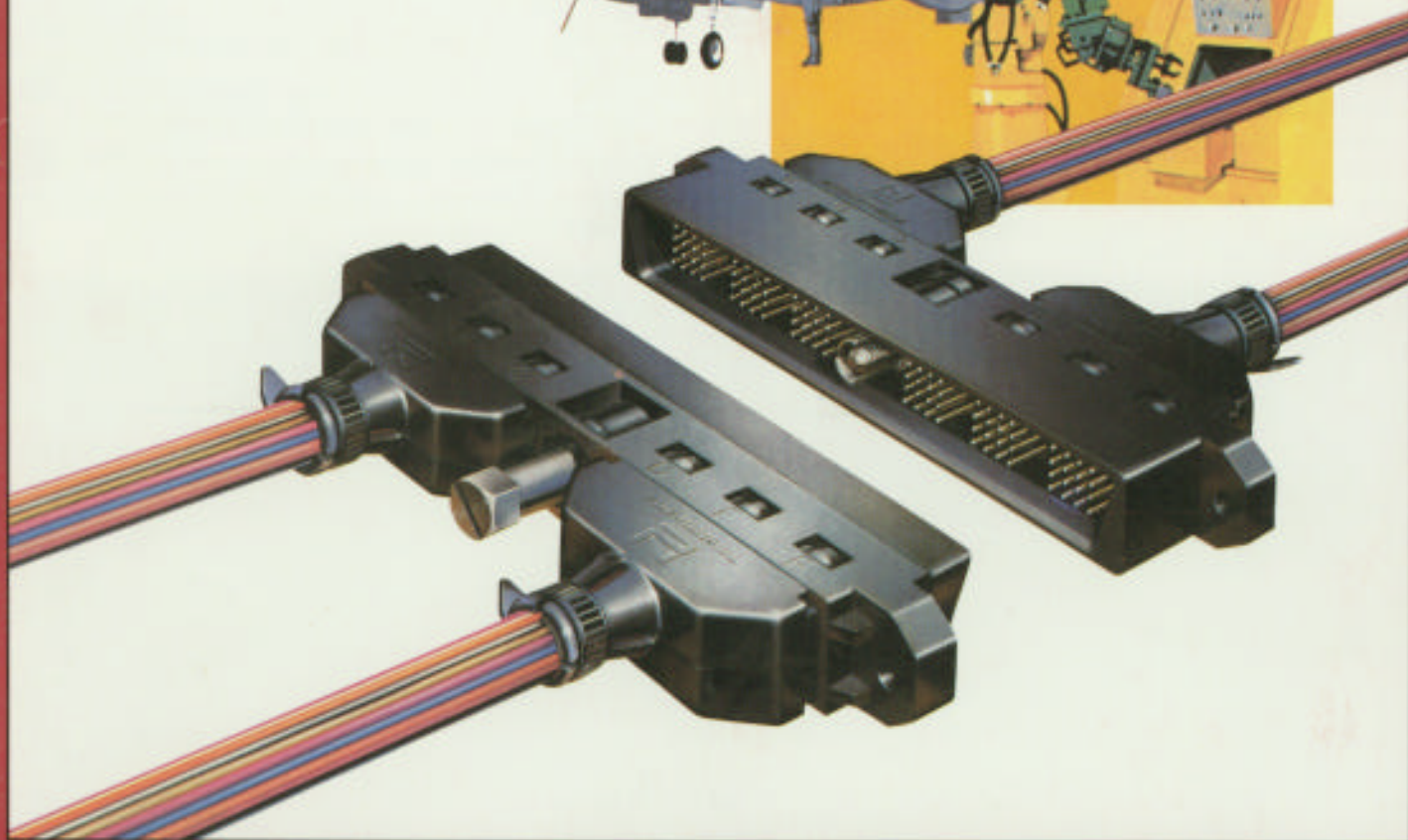

Amphenol

Amphenol® /Pyle® LMD & LMS Modular Connectors

interconnection products at the wire harness level

LMD Modular Connectors

The LMD Connector Series was designed to provide flexibility in the assembly of wire harnesses that are used in instrumentation and avionic control environments.

Design Features

- An LMD Connector is comprised of a housing, modules and contacts - each ordered separately, requiring assembly
- Lightweight housings are offered in three materials
 - standard black thermoplastic
 - high performance composite material for EMI Shielding
 - white thermoplastic nylon material with increased solvent resistance
- Four standard modules are available with the following contact arrangements: 1 #8, 4 #16, 9 #20, 16 #22
- Modules are available in sealed and unsealed versions
- Linear module design may be used for rack and panel or cable to cable applications
- Right angle receptacle design with fixed pin contacts available for printed circuit board attachments
- Bussing modules available to allow for a plurality of circuit network configurations without extra hardware
- Diode modules provide a current protection system for avionic instrumentation packages and eliminate the need for dedicated PC boards and other hardware

- Miniature relay modules can be added which eliminate the need for printed circuit boards and hardware

LMD Benefits

- Reduces assembly and production costs
- Eliminates costly PC board and associated hardware
- Reduces inventory levels and associated costs
- Allows for a variety of circuit configurations
- Permits ease of circuit upgrading
- Facilitates equipment maintenance

LMS Modular Connectors

Supplementing the LMD connector family, Amphenol/Pyle National offers two styles of the LMS in-line splice connector, low cost interconnects that incorporate the LMD modules and contacts.

- Standard LMS splice connector - 3 piece assembly with module removal tool access
- Tool-less splice connector - 3 piece assembly with a push button module release for easy module removal
- Two-piece bracket available for panel mounting
- Used in wire harness, instrument and equipment terminations and test points

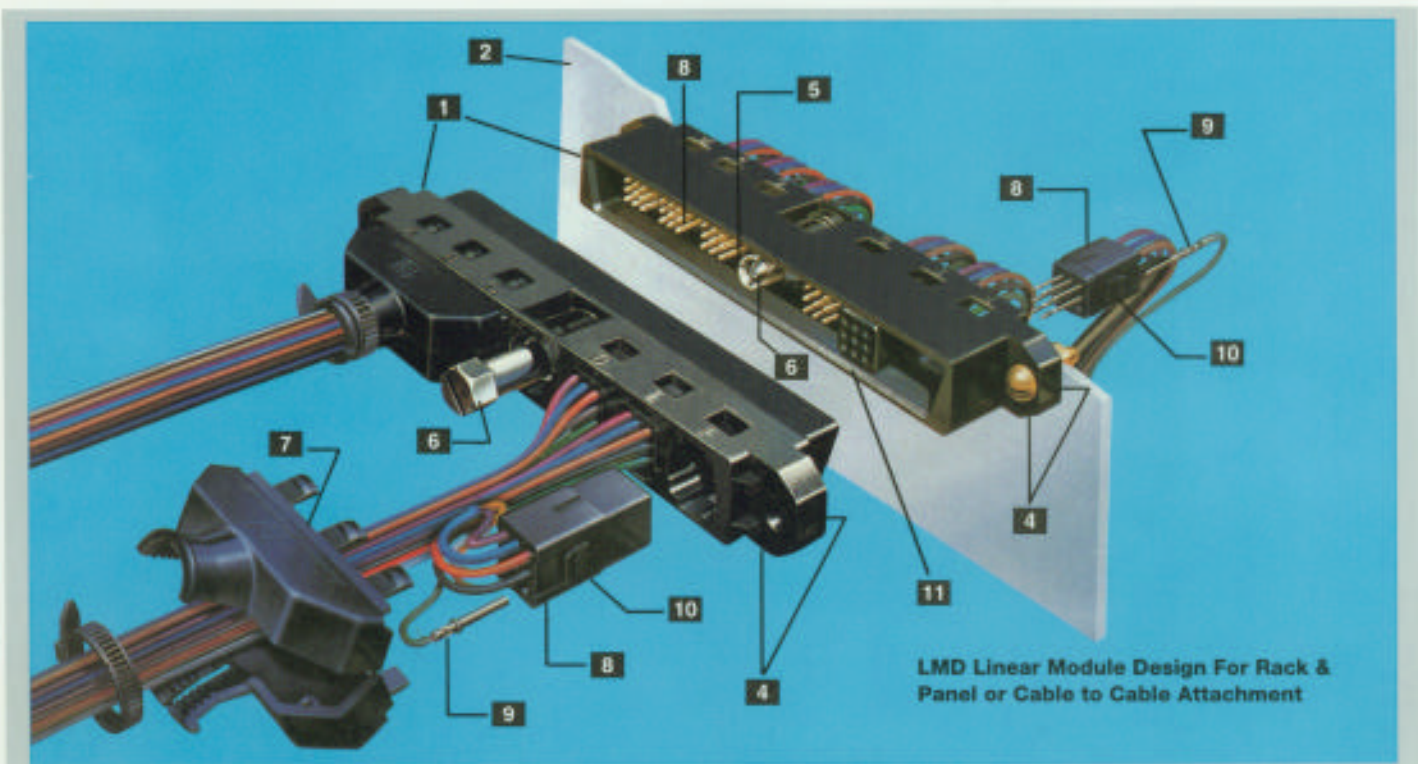

LMD Design Flexibility

module options provide a mix of both active and passive devices within one connector

LMD Features and Options

- 1 LMD Standard components are molded of a U/L rated 94VO flame retardant, light-weight thermoplastic material. Alternate white nylon material and composite material are available. See performance capabilities on the following page and consult Amphenol, Sidney, NY for availability of these optional materials.
- 2 The linear LMD connector may be used for rack and panel or cable-to-cable applications.
- 3 An LMD right angle printed circuit board receptacle with fixed pin contacts is available.
- 4 Plug and receptacle housings may be front or rear panel mounted.
- 5 Optional keying post provides six position keying capability.
- 6 The optional center jackscrew provides ease of mating and unmating and insures high reliability under vibration.
- 7 Two types of cable strain reliefs are available; for either internal or external attachment.
- 8 Sealed and unsealed modules accept rear release #8, #16, #20 and #22 gauge contacts. PC tail contacts are also available. (Consult Amphenol, Sidney, NY).
- 9 A variety of contacts accept #8 through #28 AWG wire. Commercially available automated crimp terminating equipment may be used.
- 10 Wired or unwired modules are rear inserted and held by two retention lines. With the aid of a front release tool, the modules are easily removed from the rear.
- 11 Pin or socket modules may be intermixed in plug or receptacle housings.

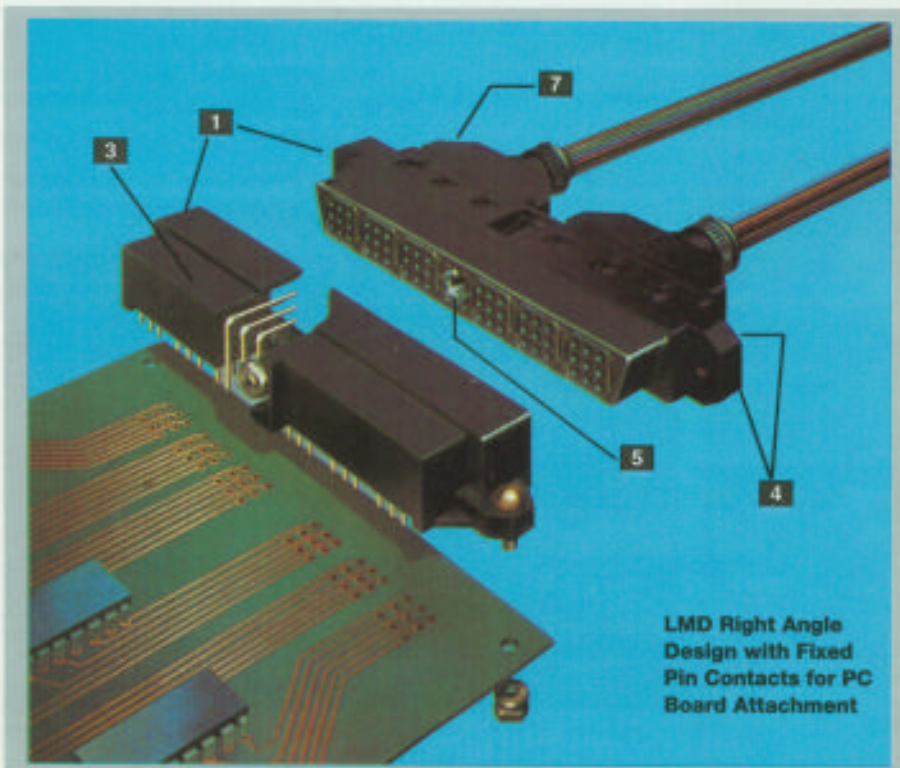

Table of Contents

Amphenol®/Pyle® LMD & LMS Modular Connectors	Page
LMD Modular Connectors	
Design Flexibility – Material Options, Contact Data, Performance Characteristics	2
Housing Specifications	3
Module Contact Configurations and Specifications	4, 5
Bussing Modules	6
Diode Modules	7
Relay Modules	8
Accessories – Strain Reliefs	9
Accessories – Crimping and Insertion/Removal Tools, Module Removal Tools	10
Assembly Instructions	11, 12
LMS In-Line Splice Connectors	
Design Features and Options	13
Accessories – Two-Piece Bracket for Panel Mounting, Module Removal Tool, Module Removal Instructions	14
Other Amphenol Products	15
Amphenol Sales Office List	16

LMD Design Flexibility

material options, contact data,
performance characteristics

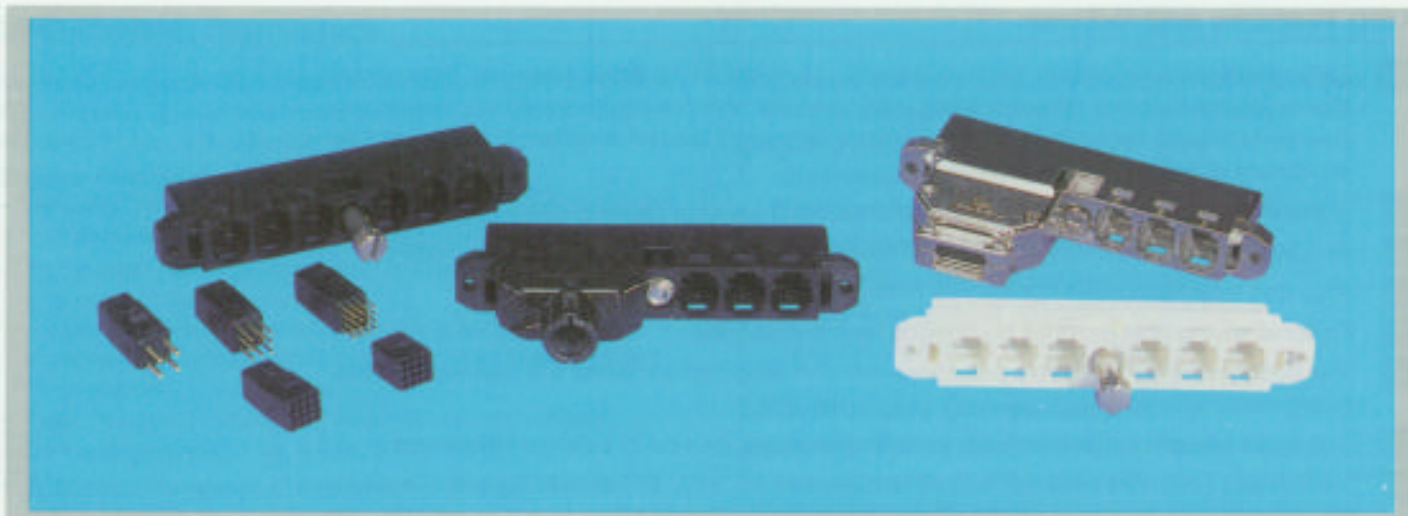

Photo above shows the variety of materials that are offered for LMD connector housings and strain reliefs.

CONTACT DATA

Contact Size	Wire Size	Contact Resistance		Dielectric Withstanding Voltage AC (RMS)	Max. Recommended Working Voltage AC (RMS)
		Test Current (Amperes)	Max. Millivolts		
22	22	5.0	73	1800	600
	28	1.5	54		
20	20	7.5	55	1800	600
	24	3.0	45		
16	16	13.0	49	2300	900
	20	7.5	46		
8 with #12 Wire Well	12	23	42	2300	900
	14	17	40		
8	8	46	26	2300	900
	10	33	26		

Contact Size	Wire Size	Contact Crimp Tensile Strength Lbs. Minimum	Maximum Wire Insulation
22	28	3	.054
	26	5	
	24	8	
	22	12	
20	24	8	.083
	22	12	
	20	20	
16	20	20	.103
	18	30	
	16	50	
8 with #12 Wire Well	14	70	.255
	12	110	
8	10	150	.255
	8	220	

MATERIAL OPTIONS FOR LMD HOUSINGS

- Black Thermoplastic:** Molded of U/L rated 94VO flame retardant, lightweight thermoplastic.
- High Performance Composite:** Molded of Composite material, nickel plated for added EMI shielding effectiveness.
NOT AVAILABLE
- White Thermoplastic Nylon:** Provides increased resistance to industrial oils and solvents.

PERFORMANCE CHARACTERISTICS

Temperature Rating	-55°C to +140°C (-67°F to +284°F)
Insulation Resistance (min.)	5000 megohms initial; 1000 megohms after 96 hours humidity
Durability	250 cycles (mating & unmating)
Vibration	Maximum discontinuity of one microsecond when subjected to sinusoidal vibration of 10 to 2000 Hz at 15 gravity units
Physical Shock	Maximum discontinuity of one microsecond when subjected to 1/2 sine-wave transient shock of 50 gravity units with pulse duration of 11 milliseconds
Module Insertion & Removal Force	5 lbs. maximum
Module Retention	70 lbs. minimum

See page 9 for information on strain reliefs.

NOTE: Module inserts are currently available in the standard black thermoplastic only. For future availability of material other than standard black, consult Amphenol, Sidney, NY.

LMD Connector housing specifications

NOT AVAILABLE

6 BAY LMD HOUSINGS

RECEPTACLE HOUSING RIGHT ANGLE PC TYPE, 6 BAY

Standard Black Thermoplastic: LMD-06BE()-01PJ*
 High Performance Composite: LMD-C6BE()-01PJ*
 White Nylon Material: LMD-F6BE()-01PJ*

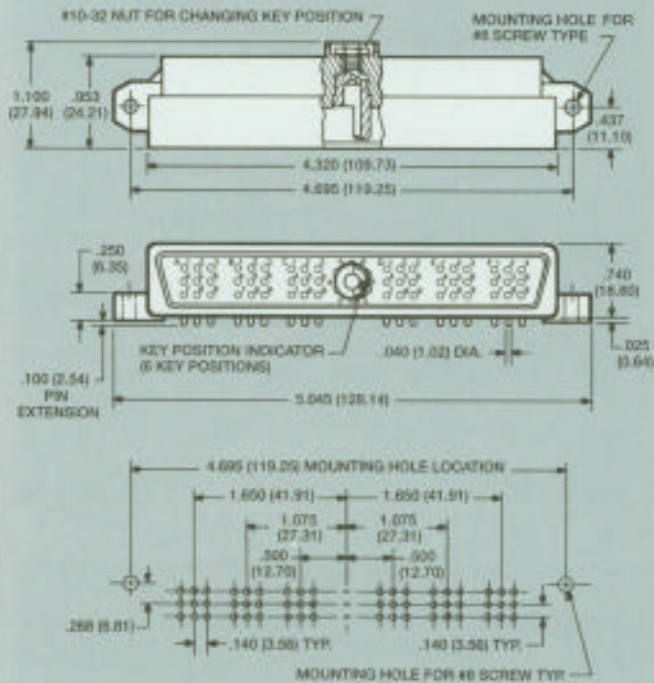

RECEPTACLE HOUSING, 6 BAY

Standard Black Thermoplastic: LMD-06RK()*
 High Performance Composite: LMD-C6RK()*
 White Nylon Material: LMD-F6RK()*

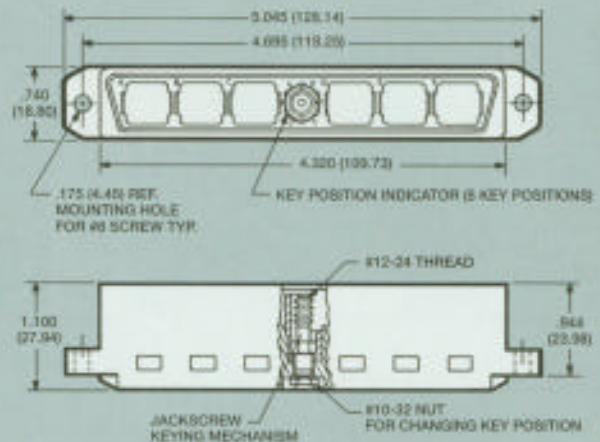

PLUG HOUSING, 6 BAY

Standard Black Thermoplastic: LMD-06PJ()*
 High Performance Composite: LMD-C6PJ()*
 White Nylon Material: LMD-F6PJ()*

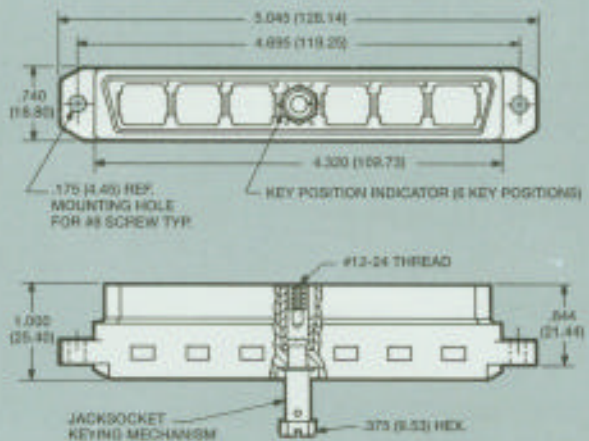

HOW TO ORDER LMD HOUSINGS

* Housings are ordered separately from modules and contacts. Sample part number is shown as follows:

LMD - 0 6 P J ()

PRODUCT DESIGNATION

HOUSING MATERIAL**

0 designates standard black thermoplastic material
 C designates high performance composite material
 F designates white thermoplastic nylon material

NUMBER OF MODULES

(Cavities in plug or receptacle housing)

CONNECTOR TYPE

P designates plug
 R designates receptacle
 B designates PC receptacle with 90° fixed pin contacts

COUPLING MECHANISM

J designates jack-socket, rotating
 K designates jack-screw, fixed
 E designates without coupling mechanism

ALTERNATE KEYING (6 Positions) 1, 2, 3, 4, 5 or 6

Replace parenthesis () with alternate keying position desired.
 7 designates keying hardware shipped unassembled for field assembly
 8 designates no alternate keying hardware. Keyed through housing only.

** Housing material is standard black thermoplastic; for other materials, consult Amphenol, Sidney, NY for availability.

Note: See strain reliefs for use with 6 bay LMD connectors on page 9.

See Amphenol Product Data Sheet #176 which provides information on the availability of 4 bay and 2 bay plug and receptacle housings.

LMD Connector

module contact configurations and specifications

16 #22 CONTACTS

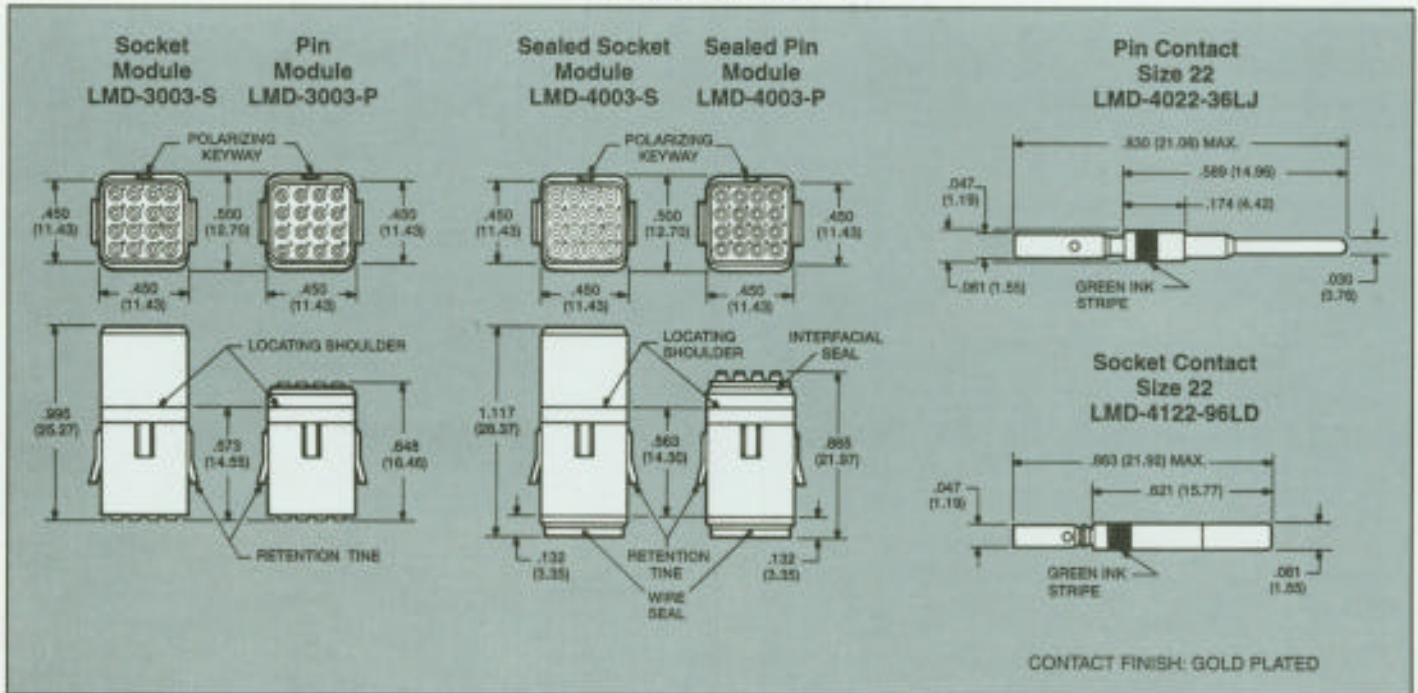

9 #20 CONTACTS

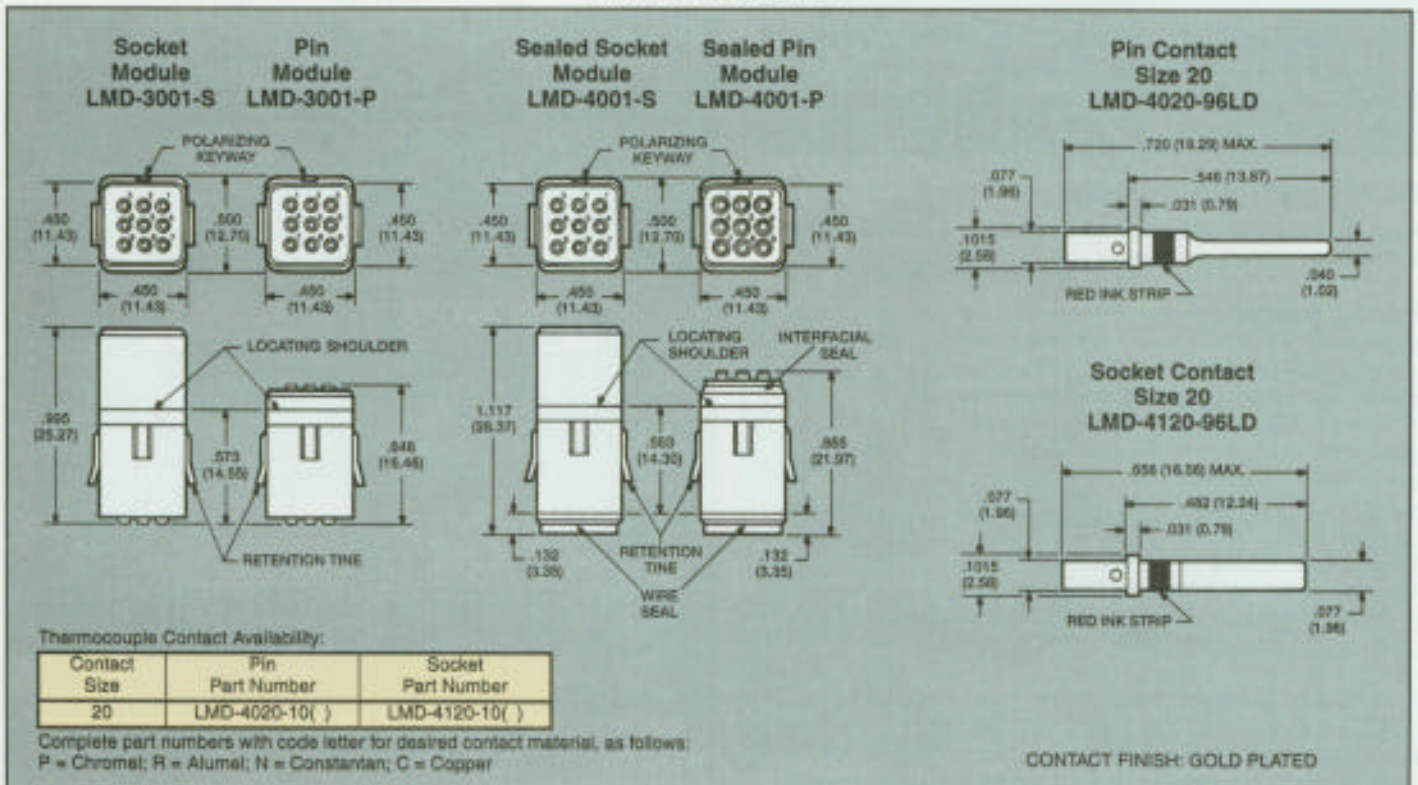

NOTE: MODULES AND CONTACTS ARE SOLD SEPARATELY FROM CONNECTOR HOUSINGS.
 Order modules and contacts by part numbers shown above.
 For information on the availability of module material other than black thermoplastic, consult Amphenol, Sidney, NY.

LMD Connector

module contact configurations and specifications

4 #16 CONTACTS

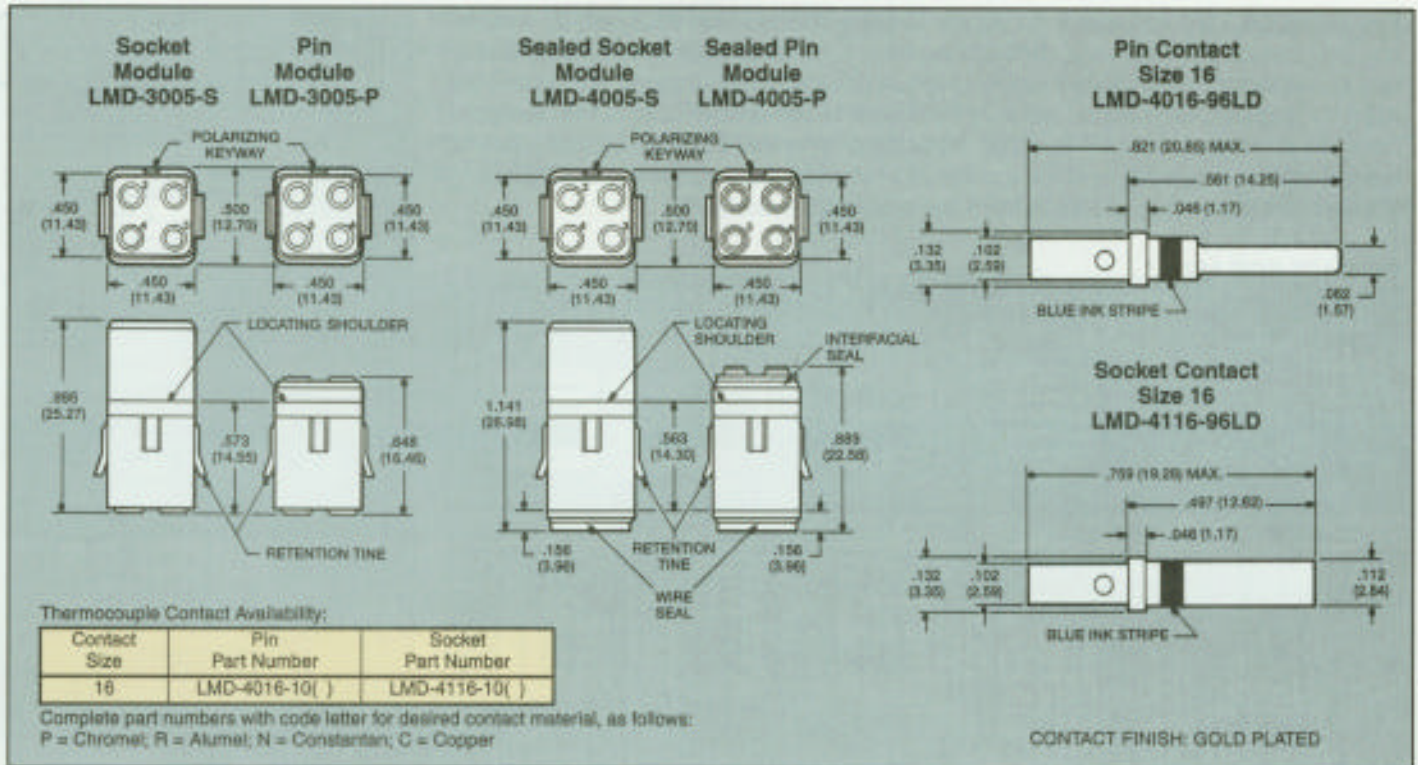

1 #8 CONTACT

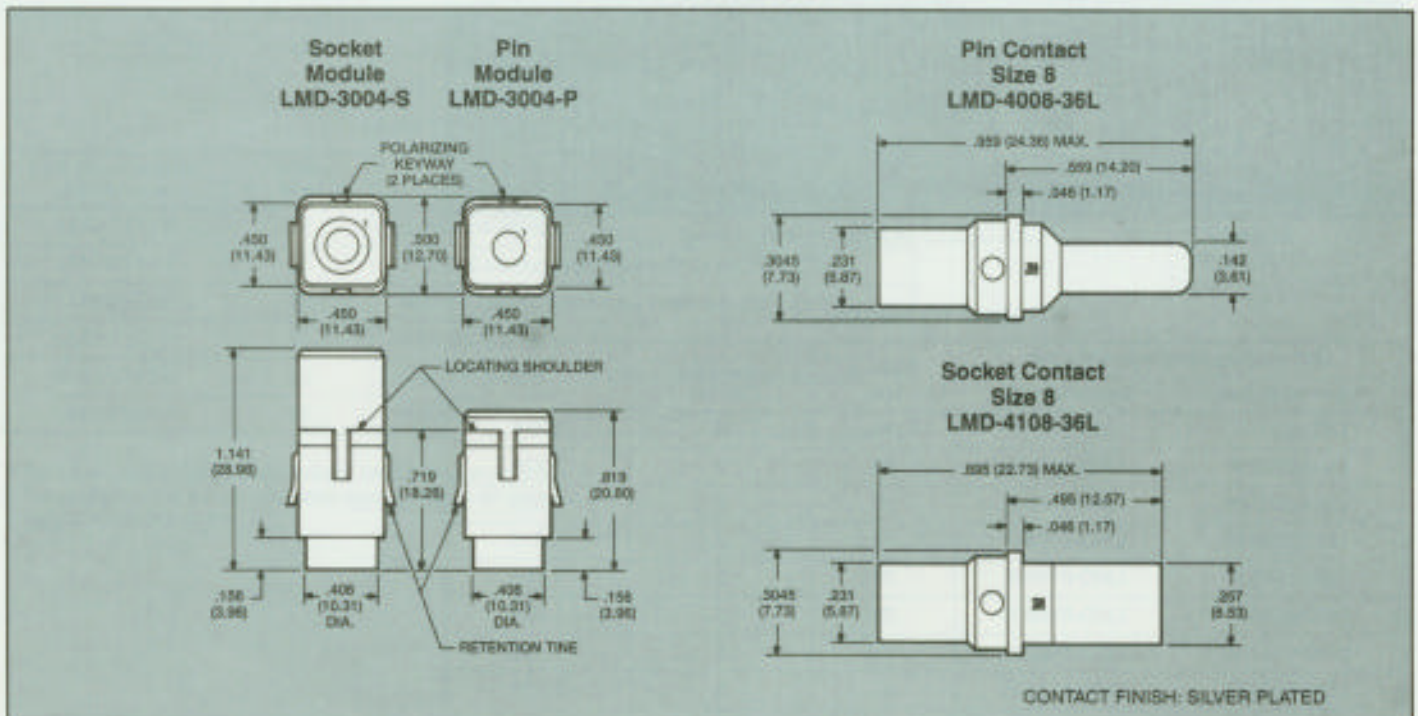

NOTE: MODULES AND CONTACTS ARE SOLD SEPARATELY FROM CONNECTOR HOUSINGS.

Order modules and contacts by part numbers shown above.
 For information on the availability of module material other than black thermoplastic, consult Amphenol, Sidway, NY.

LMD Connector

bussing modules – for plural circuit networks

Expanding the LMD connector family, the Bussing Module was designed by Amphenol, Pyle-National to provide a complete terminal junction system. This module conveniently and simply allows for a plurality of circuit network configurations, eliminating the need for "pigtaills", termination strips or termination hardware. Nine bussing configurations are currently available* in either a standard or sealed module. Sealed modules have a rubber interfacial seal for increased environmental resistance. LMD Bussing Modules are currently available in black thermoplastic material.**

CONTACT SIZE #22



CONTACT SIZE #20

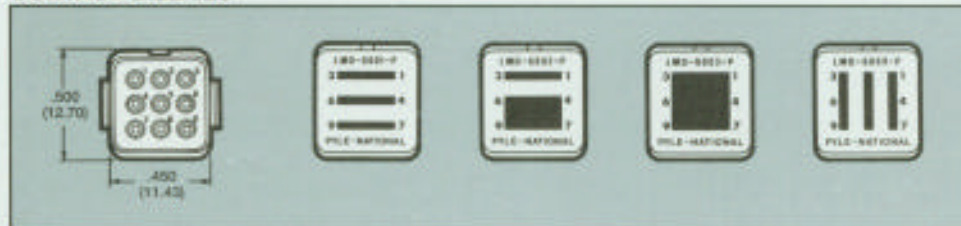

CONTACT SIZE #16

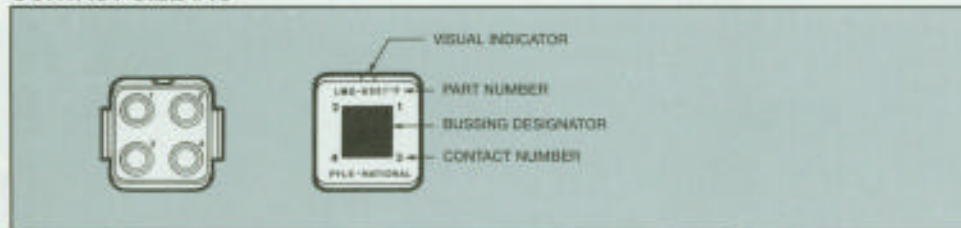

CONTACT
(FRONT VIEW)

BUSSING CONFIGURATION
(REAR VIEW)

HOW TO ORDER

LMD Bussing Module Part Number		Contact Size	Bussing Circuits	A Ref.
Standard Module	Sealed Module			
LMD-6001-P	LMD-6101-P	20	3	1.326
LMD-6002-P	LMD-6102-P	20	2	1.326
LMD-6003-P	LMD-6103-P	20	1	1.326
LMD-6004-P	LMD-6104-P	22	4	1.256
LMD-6005-P	LMD-6105-P	22	2	1.256
LMD-6006-P	LMD-6106-P	22	1	1.256
LMD-6007-P	LMD-6107-P	16	1	1.326
LMD-6008-P	LMD-6108-P	22	3	1.256
LMD-6009-P	LMD-6109-P	20	3	1.326

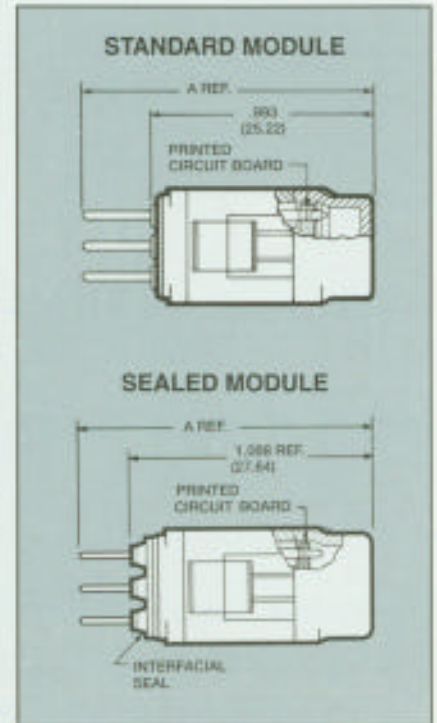

MODULE
(SIDE VIEW)

* For other circuit network configurations, consult Amphenol, Sidney, NY.

** For availability of materials other than standard black thermoplastic, consult Amphenol, Sidney, NY.

LMD Connector

diode modules – for increased current protection

The Diode Module was designed to provide a current protection system for Avionic instrumentation packages. Module configurations represent standard system and test application requirements.*

Diode Modules eliminate dedicated P. C. boards and other assorted hardware. These modules are available in sealed type only, incorporating an interfacial seal for environmental protection, and are manufactured of black thermoplastic material.**

CONTACT SIZE #22

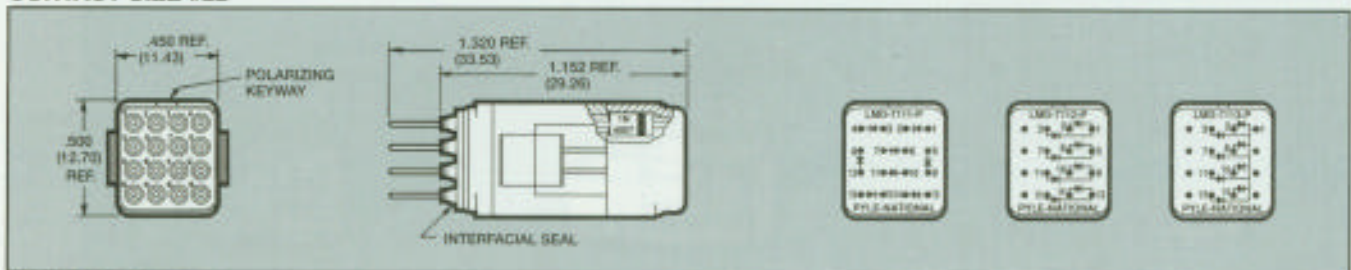

CONTACT SIZE #20

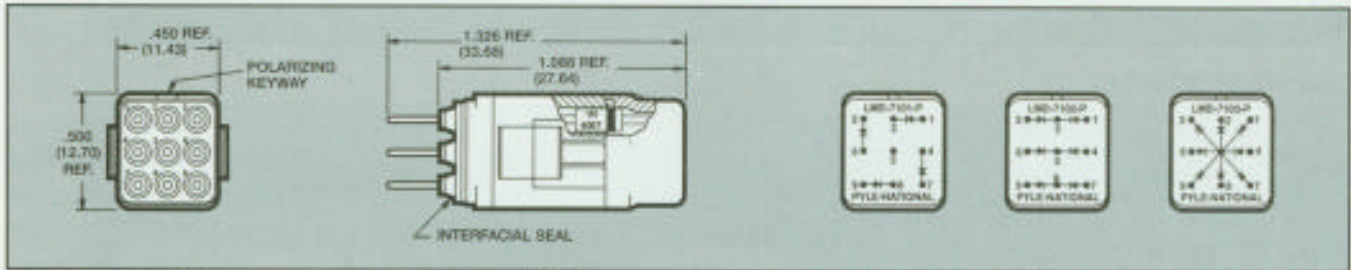

CONTACT
(FRONT VIEW)

MODULE
(SIDE VIEW)

DIODE CONFIGURATION
(REAR VIEW)

HOW TO ORDER

LMD Diode Module Part Number	Contact Size	Circuit Description
LMD-7111-P	22	8 discrete diodes
LMD-7112-P	22	4 pair of diodes, each pair with common cathode
LMD-7113-P	22	8 diodes with common cathode (pin #1)
LMD-7101-P	20	4 discrete diodes
LMD-7102-P	20	3 pair of diodes, each pair with common cathode
LMD-7103-P	20	8 diodes with common cathode (pin #5)

* For other circuit network configurations, consult Amphenol, Sidney, NY.

** For availability of materials other than standard black thermoplastic, consult Amphenol, Sidney, NY.

LMD Connector

relay modules – improved component packaging

The Relay Module represents another innovative concept which was designed for the LMD connector. Incorporating an industry standard miniature relay per MIL-R-39016 specification part number M39016/19-036L*, these modules eliminate the need for a printed circuit board and all related hardware. These modules are available in unsealed or sealed types as shown below, and are manufactured of black thermoplastic material.**

STANDARD RELAY MODULE

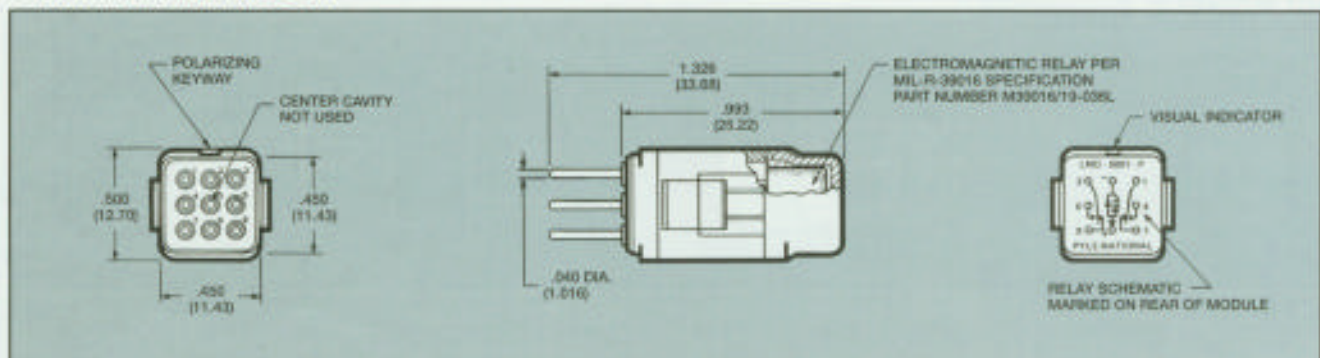

SEALED RELAY MODULE

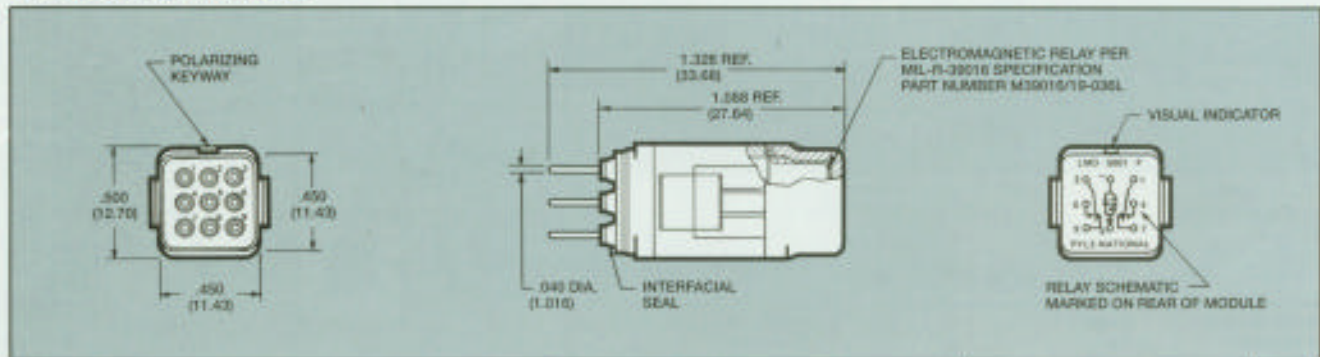

CONTACT
(FRONT VIEW)

MODULE
(SIDE VIEW)

RELAY CONFIGURATION
(REAR VIEW)

HOW TO ORDER

LMD Relay Module Part Number	
Standard Module	Sealed Module
LMD-5001-P	LMD-5101-P

* For other circuit network configurations, consult Amphenol, Sidney, NY.

** For availability of materials other than standard black thermoplastic, consult Amphenol, Sidney, NY.

LMD Accessories

strain reliefs

STRAIN RELIEF FOR INTERNAL ATTACHMENT

Part Number LMD-5300-10A

Two-piece strain relief with cable tie included, for internal attachment to LMD 6 bay connector housings. Molded in black thermoplastic material.

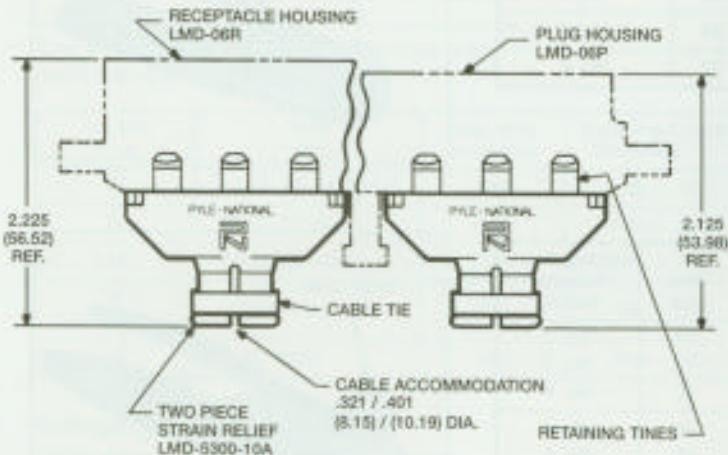

STRAIN RELIEF FOR EXTERNAL ATTACHMENT

Part Number LMD-5300-50-A

Two-piece strain relief with screws and adjustable clamp (see below for variations), for external attachment to LMD 6 bay connector housings. Material is high performance composite, nickel plated.

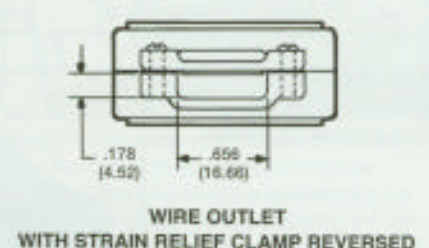
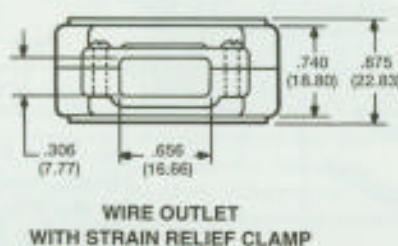
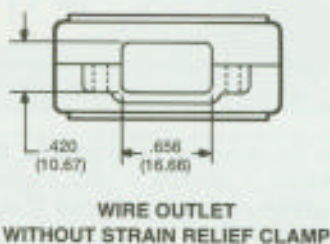
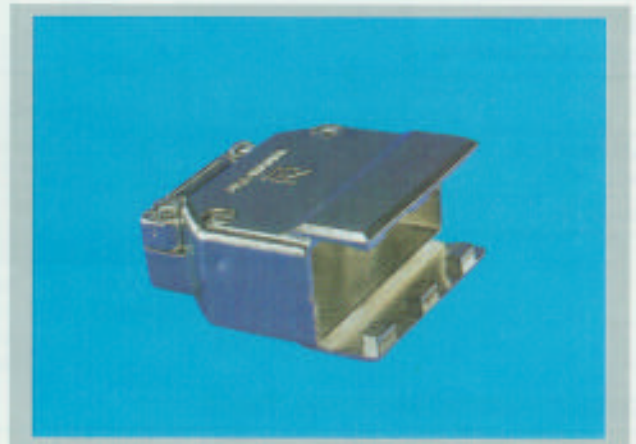
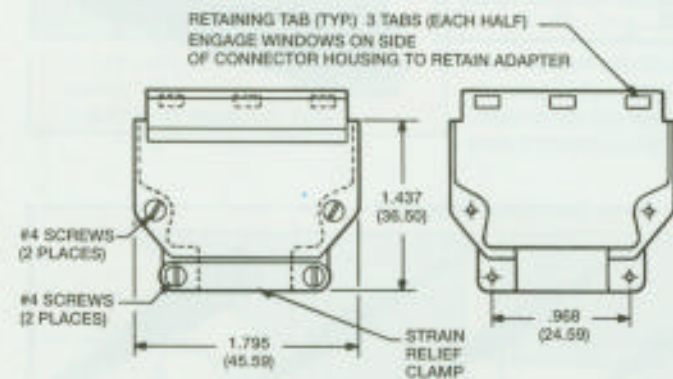

LMD Accessories

crimping and insertion/removal tools,
module removal tool

CRIMPING TOOL for Size #22 Contacts

	Crimping Tool Part Number	Positioner	
		For Pin Contact	For Socket Contact
Amphenol/Pyle-National No.	TP-201401-H2	TP-201409	TP-201401-2-07
Military No.	M22520/2-01	-	M22520/2-07

Wire Size	Crimp Tool Selector Setting
28	No. 1
26	No. 2
24	No. 3
22	No. 4

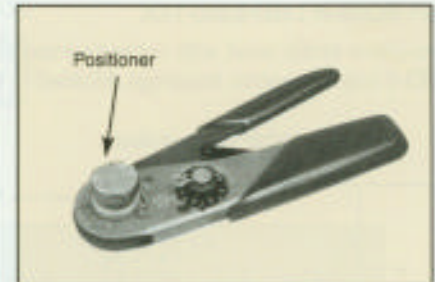

CRIMPING TOOL for Size #20 and Size #16 Contacts

	Crimping Tool Part Number	Turret Head
Amphenol/Pyle-National No.	TP-201354	TP-201355
Military No.	M22520/1-01	M22520/1-02

Contact Size	Wire Size	Crimp Tool Selector Setting
20	24	No. 2
	22	No. 3
	20	No. 4
16	20	No. 4
	18	No. 5
	16	No. 6

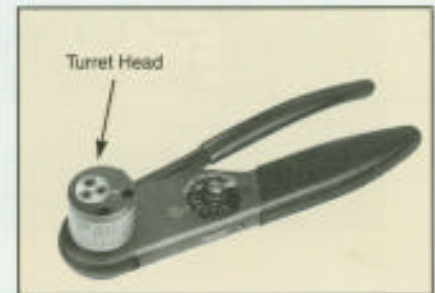

CRIMPING TOOL for Size #8 Contacts

	Crimping Tool Part Number	Locator
Amphenol/Pyle-National No.	TP-201393	TP-201408
Military No.	-	-

For Size 8 Contacts		For Size 8 Contacts with #12 Wire Well	
Wire Size	Crimp Tool Selector Setting	Wire Size	Crimp Tool Selector Setting
10	No. 5	14	No. 2
8	No. 7	12	No. 3



CONTACT INSERTION/REMOVAL TOOLS

Contact Size	Color	Amphenol/Pyle-National Part No.	Military Part No.
22	Green	10-538988-22D	MIL-I-81969/14-01
20	Red	10-538988-201	MIL-I-81969/14-02
16	Blue	10-538988-016	MIL-I-81969/14-03
8	Red	TP-201406	MIL-I-81969/29-02

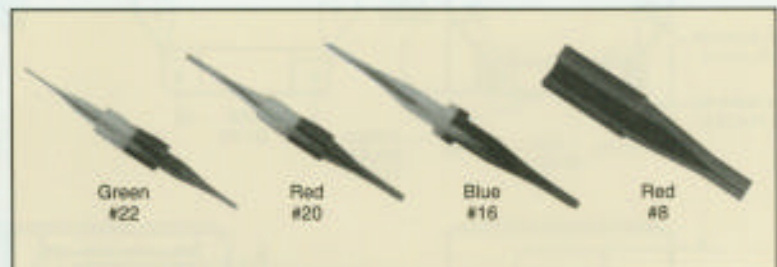

LMD MODULE REMOVAL TOOL

Part Number TP-201397



See on the following page the assembly instructions for proper crimping, insertion and removal of contacts in LMD connectors. See also instructions for insertion of modules and how to use the LMD module removal tool, on page 12.

LMD tools can be purchased from Daniels Manufacturing Company.

Assembly Instructions for LMD Connectors

Wire Preparation



Strip wires to dimension "A" shown in table below. Avoid cutting or nicking wire strands.

Contact Size	Wire Size	Max. O. D. Insulation	Stripping Length Dimension "A"
22	22-24-26-28 AWG	.054	.156 - .125
20	20-22-24 AWG	.063	.185 - .155
16	16-18-20 AWG	.103	.260 - .230
8 (with #12 crimp)	12-14 AWG	.255	.395 - .365
8	8-10 AWG	.255	.395 - .365

Crimping Wire to Contacts

Follow steps 1-3 for proper contact crimping.

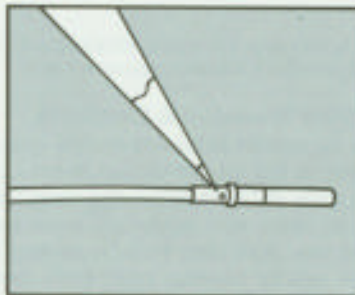

1. Fully insert wire into contact crimp pocket. Wire must be visible through wire inspection hole.

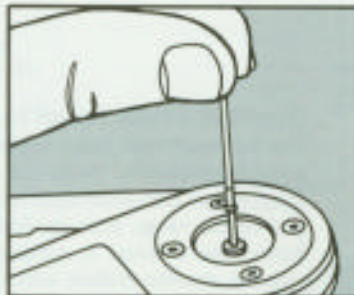

2. Insert contact into tool (use proper crimping tool as listed on page 10). Crimp contact to wire. Tool will not open if contact is not fully crimped.

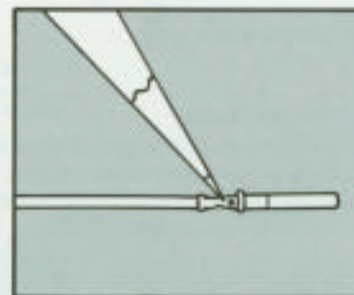

3. After crimping, wire should be visible through wire inspection hole.

Contact Insertion

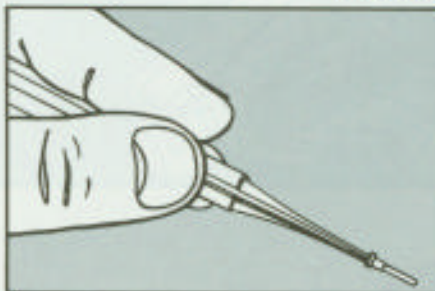

Using proper insertion/removal tool as listed on page 10, slip wire into insertion end (colored end), placing crimp end of contact inside the slotted portion and contact shoulder against end of tool.

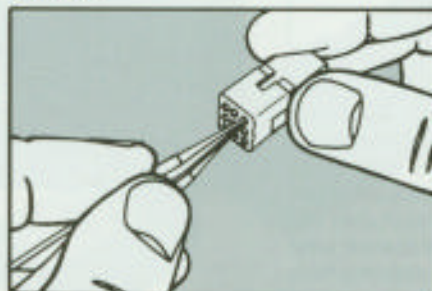

Align contact with the cavity at the rear face of the module. Carefully push the contact into the full depth of the cavity. Withdraw tool. A slight axial pull on the wire will confirm contact is locked in proper position.

Contact Removal

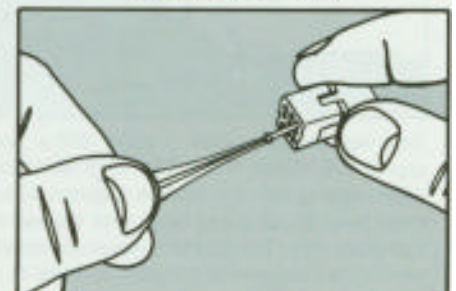

Snap the extraction end (white end) of the tool over the wire of the contact selected for removal. Carefully push the tool into the full depth of the contact cavity releasing the contact retaining collet. Hold the wire against the serrations on the tool, and withdraw the tool and the wired contact from the module.

Assembly Instructions for LMD Connectors

Pin or socket modules, wired or unwired, can be inserted or intermixed in plug or receptacle housings. Select from standard module configurations shown on pages 4 and 5, or select the optional bussing, diode or relay modules offered, shown on pages 6-8. The next instructions illustrate the proper method of insertion and removal of modules within the LMD connector.

Module Insertion

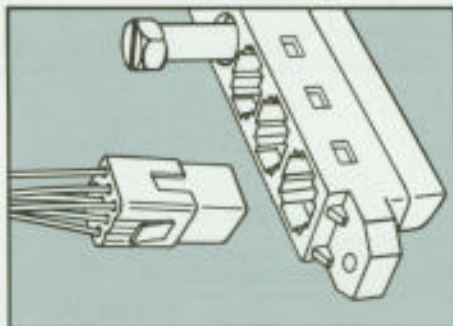

Align the module with the proper cavity at the rear of the housing. The module keyway must be positioned to accept key in housing cavity. Carefully insert the module straight into the cavity until fully seated and locked in place. A slight axial push on the front of the module or a pull on the cable bundle will confirm module is locked in proper position.

Module Removal

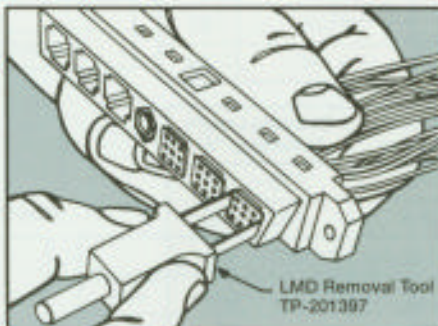

Select module to be removed and place the blades of removal tool into the removal slots at the front of the connector. Push the removal tool into the full depth of the cavity, releasing the module retention tines.

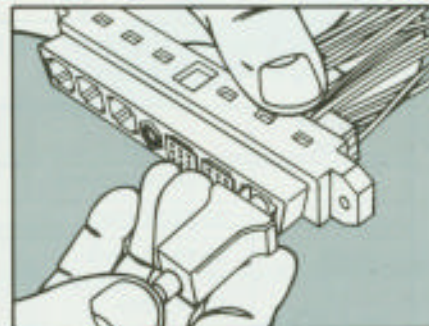

With the module removal tool fully inserted, push the extraction plunger to eject the module out of the rear of the connector.

Assembly of Internal Strain Relief

Strain reliefs, if required, may be assembled to plug or receptacle connectors which have a full complement of modules installed. The following is instruction for assembling the internal attachment strain relief, part number LMD-5300-10A (see page 9).

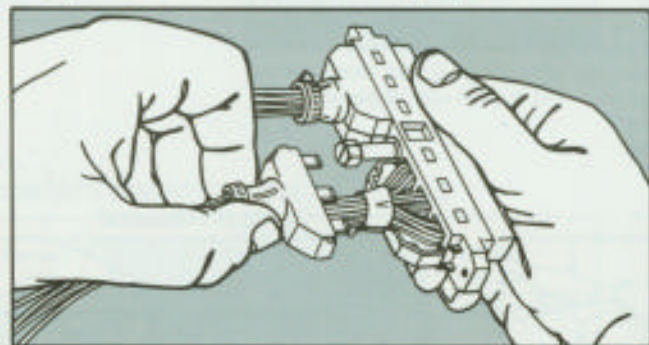

Tape wire bundle in area of cable clamp, and build up diameter to approx. 3/8 inches, if required. Align self-locking tines of the strain relief housing with the cavities adjacent to each module. Push the strain relief housing into place until the self-locking tines snap and lock strain relief into position. Assemble opposite half of strain relief housing to connector and tighten tie-strap to provide clamping force on the wire bundle.

Opening Strain Relief to Service Modules & Contacts

Internal attachment strain reliefs may be opened to provide module and/or contact accessibility. To service connectors, first cut and discard tie-strap on strain relief. Open strain relief halves approx. 45° each by bending along integral flexible hinge. After servicing, close strain relief halves and install and tighten new tie-strap. To completely remove strain relief from the housing in order to provide module access: first remove tie-strap, open strain relief halves 45° each, then remove module, then remove strain relief.

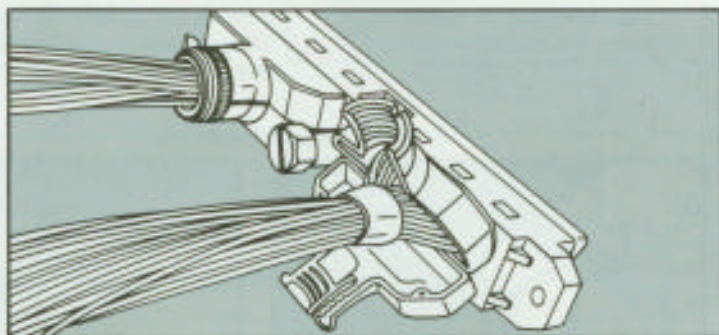

Assembly of External Strain Relief

External attachment strain relief, part number LMD-5300-50-A (see page 9), has a simpler procedure of assembly and removal, as follows: To attach, position the strain relief housing into slots of connector housing and the clamp bar over wires. Tighten clamp bar with screws. The cable opening can be adjusted by repositioning the clamp bar (refer to page 9 to see the variations of using this clamp bar). To disassemble, in order to service modules and contacts, simply loosen the screws of the cable clamp and remove the strain relief housing.

LMS In-Line Splice Connector

simple, low cost interconnection device

To supplement the LMD Connector family, Amphenol/Pyle offers two styles of the LMS in-line splice connector which incorporates the LMD modules and contacts.

These simple, compact, three-piece assemblies are used in the following applications:

- Instrument terminations
- Wire harness terminations
- Equipment terminations
- Test points

The LMS-01T standard splice requires module removal tool TP-201399. (See page 14 for instructions on removing modules from LMS connectors). The LMS-01T-TL incorporates an integral release mechanism for easy tool-less module removal. Both types are manufactured of black thermoplastic material* and are temperature rated at -55°C to $+140^{\circ}\text{C}$ (-67°F to $+284^{\circ}\text{F}$). Both types can be attached to panels with either a tie strap or with the LMS-B1-01 two-piece bracket which is shown on page 14.

Refer to pages 4-8 for the available modules and contact configurations that can be incorporated into LMS connectors.

* For availability of materials other than standard black thermoplastic, consult Amphenol, Sidney, NY.

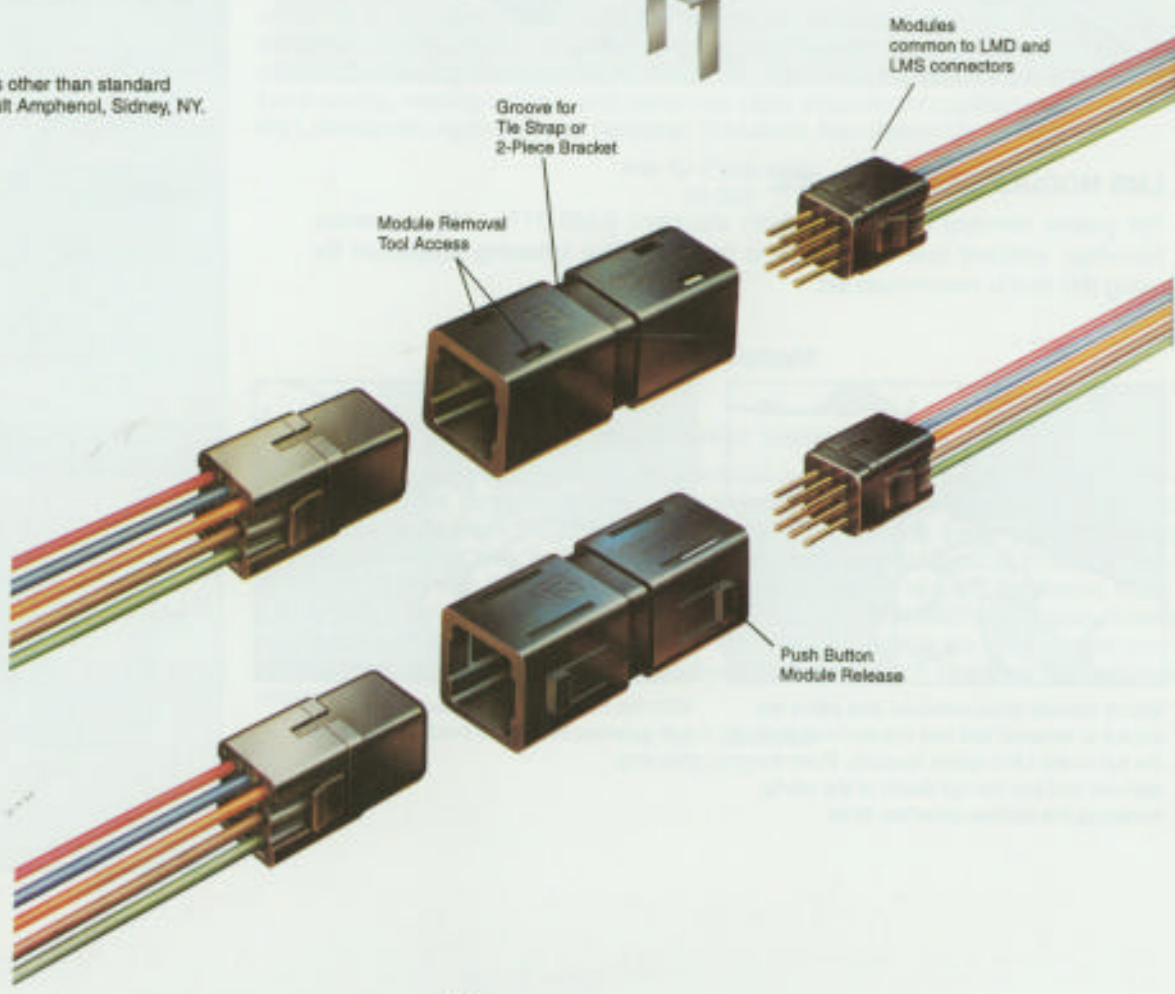
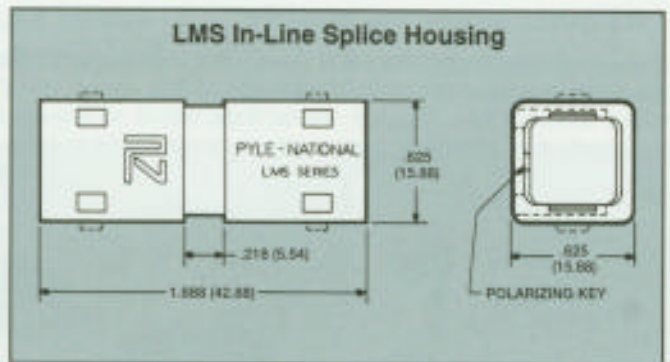

LMS-01T
Standard Splice

LMS-01T-TL
Double-ended
Tool-less Splice
Housing

LMS Accessories

panel mounting bracket, module removal tool/instructions

LMS PANEL MOUNTING BRACKET

For panel mounting of the LMS Connector, a two-piece bracket is available as shown below:

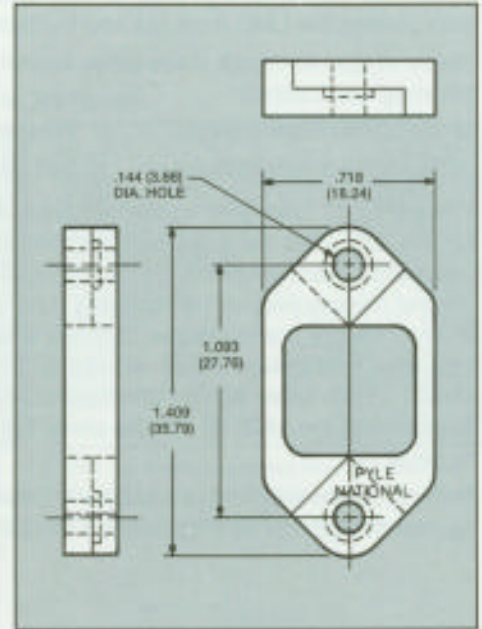
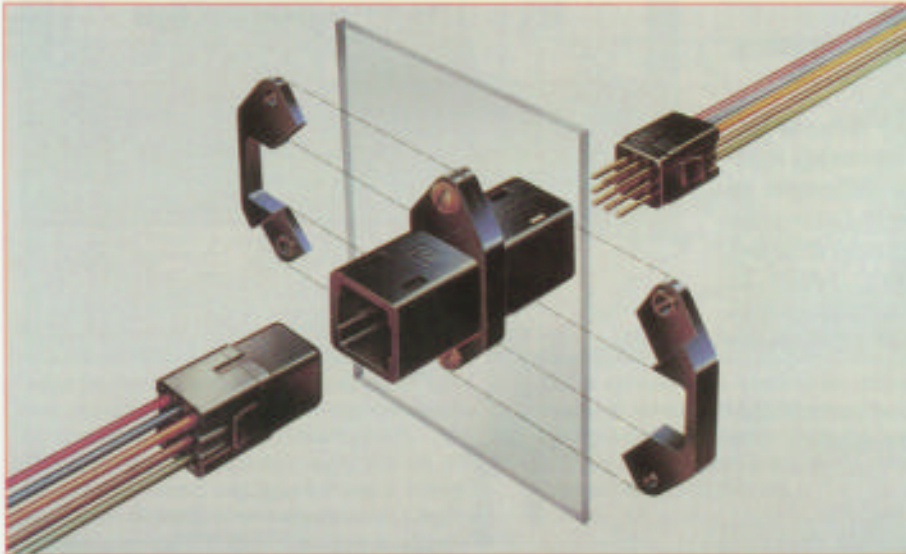

LMS MODULE REMOVAL TOOL

For proper removal of modules from standard (LMS-01T) LMS connector housings, removal tool TP-201399 is required. The following procedure for using this tool is recommended.

Module Removal

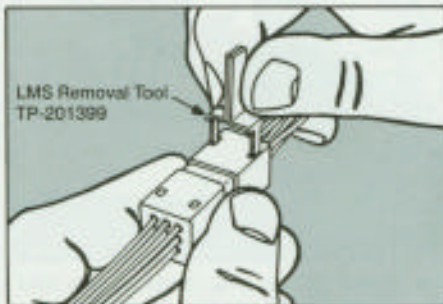

Select module to be removed and place the blades of removal tool into the removal slots at the top of the LMS splice housing. Push the removal tool into the full depth of the cavity, releasing the module retention lines.

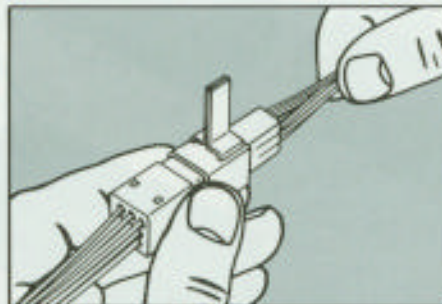

With the module removal tool fully inserted, pull on wires to remove module from splice housing.



Other Products from Amphenol

interconnection products for aerospace and industrial applications

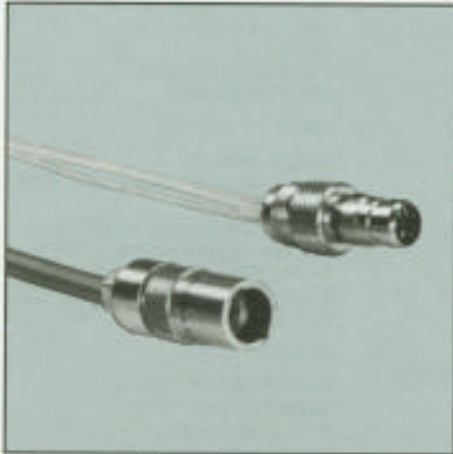

SUBMINIATURE T-LINE SERIES

Amphenol/Pyle-National® T-Line subminiatures are a push-pull, space saving connector design utilizing MIL-C-38999 inserts and standard M39029/56,/58 series contacts. Easily adapted for lanyard release or in-line applications. Rugged environmental design available with stainless steel or aluminum shell with various plating options. Used in the mass transportation market.

Ask for Publication
TL-100



97 SERIES MS-A, MS-B

Low cost general duty, non-environmental MIL-C-5015 type connectors featuring hard dielectric inserts. Available in either MS-A type solid or MS-B type split shell styles with solder or crimp (rear release) terminations. This series of cylindrical connectors has threaded coupling and a single key/keyway polarization. Special plating finishes are available, including black zinc alloy. The 97 Series is used extensively in the machine tool industry, welding industry and numerous other commercial applications. Underwriters Laboratories Approved and Canadian Standards Association Certification.

Ask for Publication
12-022



MINIATURE CYLINDRICAL MIL-C-26482 SERIES

Medium size, environmental resistant cylindrical connector that is MIL-C-26482 qualified. This family of connectors, known as either PT or PC types, operates at 1000 VAC (RMS) voltage (sea level), has quick bayonet coupling, and has seven mounting styles and ten shell sizes. Other features include: crimp, solder or printed circuit board termination; sizes 12 through 20 contacts, coax and thermocouple on request. Numerous industrial plating finishes are available. Also available are hermetic seal (glass fused) receptacles with EMI protection, if required. Miniature cylindricals are used in instrumentation/control, machine tool and the geophysical industries. Underwriters Laboratories recognized.

Ask for Publication
12-070

Amphenol Corporation Amphenol Aerospace

40-60 Delaware Avenue
Sidney, NY 13838-1395
Phone: 607-563-5011
1-800-678-0141
Fax: 607-563-5157

Amphenol Canada

20 Mellord Drive
Scarborough, ON M1B 2X6
Canada
Phone: 416-291-4401
Telex: 065 25210
Fax: 416-292-0647

SALES OFFICES

Amphenol Corporation Amphenol Aerospace

22952 Alcade Drive
Suite 110
Laguna Hills, CA 92653
Phone: 714-855-4454
1-800-678-0141
Fax: 714-855-9115

Amphenol Corporation Amphenol Aerospace

The Serge Professional Building
130 East Elm Street
Suite 105
Roselle, IL 60172
Phone: 708-893-1713
1-800-678-0141
Fax: 708-893-3958

Amphenol Corporation

Amphenol Aerospace
2010 Corporate Ridge
McLean, VA 22101
Phone: 1-800-678-0141

DISTRIBUTORS

Corporate Headquarters CAPSTONE ELECTRONICS CORP.

3254A Fraser St.
Aurora, CO 80011
Phone: 800-388-2277
Fax: 303-375-2634

ELECTRO-AIR

500 Lake Ridge Drive
Smyrna, GA 30082
Phone: 800-241-7530
Fax: 770-432-1130

TIME ELECTRONICS

1301 West Geneva Drive
Tempe, AZ 85282
Phone: 800-241-7530
Fax: 770-432-1130

SMALL DISADVANTAGED/ MINORITY DISTRIBUTOR

JRH ELECTRONICS INC.

2002 E. Lincoln Drive West
Route 73, P.O. Box 264
Marlton, NJ 08053
Phone: 800-487-9309
Fax: 609-986-8728

INTERNATIONAL

MEXICO

Amphenol Sales Office
Presidente Mazaryk No. 61-2
C.P. 11570 Mexico D.F.
Mexico
Phone: (52-5) 203-2178
Fax: (52-5) 531-9659

Europe

AUSTRIA

Amphenol Ges mbH
Tautenhayngasse 22
A-1150 Wien (Vienna)
Austria
Phone: (43-1) 985-15-11
Fax: (43-1) 982-61-01
Telex: (847) 132661 AMPHW A

GREAT BRITAIN

Amphenol Limited
Thanet Way, Whitstable
Kent CT5 3JF
Great Britain
Phone: (441-227) 773200
Fax: (441-227) 276571
Telex: (851) 966507 AMPHNL G

Amphenol Limited

Spectra Strip Limited
Romsey Industrial Estate
Greatbridge Road
Romsey, Hampshire SO5 0HR
Great Britain
Phone: (441-794) 517575
Fax: (441-794) 516246

Pyle-National LTD

Sherbrook Road
Daybrook, Nottingham
Great Britain NG56AT
Phone: (441-159) 208116
Fax: (441-159) 208896

FRANCE

Amphenol Socapex
5 rue du President Kruger
B.P.5
92403 Courbevoie Cedex
France
Phone: (33-1) 49 05 39 22
Fax: (33-1) 43.33.11.25
Telex: MSTH 215709F
ASF CSV TX

GERMANY

Amphenol-Tuchel Electronics GmbH
August-Haesser Strasse 10
Postfach 1110
74001 Heilbronn
Germany
Phone: (49-7131) 929 0
Fax: (49-7131) 929 414
Telex: (841) 728 816

ITALY

Amphenol Italia S.P.A.
Galleria Gandhi, 2-27
20017 Mazzo di Rho
Milano
Italy
Phone: (39-2) 939-04192
Fax: (39-2) 939-01030

NETHERLANDS

Amphenol Benelux B.V.
P.O. Box 63
3990 DB Houten
The Netherlands
Phone: 31-30635-8000
Fax: 31-30637-7899

SPAIN

Amphenol Espana C.C.
Sucursal
C/Cuba No.6, 2-5
28820 Coslada, Madrid
Spain
Phone: 34-1-673-2235
Fax: 34-1-674-0893

SWEDEN

Amphenol Scandinavia
Johannalundsvagen 2
194 02 Upplands Vaesby
P.O. Box 2047
Sweden
Phone: (46-8) 590-77100
Fax: (46-8) 590-33800

Near East

ISREAL

Bar-Tec Ltd.
11 Barliam St., P.O. Box 279
Kfar Saba 44102
Israel
Phone: (972-9) 7674097
Fax: (972-9) 7674324
Telex: (922) 35587 INBAR IL

Far East

HONG KONG

Amphenol East Asia Ltd.
Units 3 to 19, 10/F & the 11/F
Wah Luen Industrial Center
15-21 Wong Chuk Yeung Street
Fotan, Shatin, N. T.
Hong Kong
Phone: (852) 8125-2663
Fax: (852) 8125-0974

KOREA

1st Floor, Ye Sam Building
#476-25, Seokyo-dong
Mapo-ku
Seoul, Korea
Phone: (82-2) 334-4198
Fax: (82-2) 647-1492

TAIWAN

Amphenol East Asia, Ltd.
12 Hsin-Pei-Yuan Road
Chungli Industrial Zone
Taoyuan Hsien, Taiwan, R.O.C.
Phone: (886-3) 482-9445
Fax: (886-3) 451-4062

SINGAPORE

Amphenol East Asia, Ltd.
80 Genting Lane
No. 09-04 Genting Block
Ruby Industrial Complex
Singapore 1334, R.O.C.
Phone: (65) 7433022
Fax: (65) 7432466

INDIA

Amphetronix Ltd.
105 Bhosari Industrial Area
Post Box No. 1
Pune, 411 026
India
Phone: (91-212) 790363
Fax: (91-212) 790581
Telex: (953) 146237

JAPAN

Amphenol Japan, K. K.
689-1, Aza Nogami, Iseochi
Ritto-Cho, Shiga 520-30
Japan
Phone: 81-77553-8501
Fax: 81-77551-2200

Africa

SOUTH AFRICA

Pace Electronic Components (PTY)
Ltd.
Cnr. Vansacht & Gewel Streets
P.O. Box 701, Isando 1600
South Africa
Phone: 27-11-974-1211
Fax: 27-11-974-1271

Australia

Australia & New Zealand Amphenol Sales Office

55 Saint Vincent St.
Port Adelaide
South Australia 5015
Phone: (61-8) 341-0665
Fax: (61-8) 341-1588

EDWARD KELLER PTY LTD

3 Walker St.
Braeside Victoria 3195
Australia
Phone: (61-3) 580 1666
Fax: (61-3) 587 3373

AMTRON AUSTRALIA

P.O. Box 312
687 Gardeners Road
Mascoot, N.S.W. 2020
Australia
Phone: (61-2) 317 5511
Fax: (61-2) 889-6216

Mouser Electronics

Authorized Distributor

Click to View Pricing, Inventory, Delivery & Lifecycle Information:

[Amphenol:](#)

[LMD-4005P](#) [LMD-3004P](#) [TP-201397](#) [LMS-B1-01](#)