

Sensitivity Wavelength Range: 600nm ~ 1750nm

The 1346 series from Marktech, a high sensitivity and high reliability product series, is ideally suited for Optical Communication devices. Custom packaging options for this die are also available.

FEATURES

- > High Speed Response (Max: 2Gbps)
- > 5mm x 5mm Seam Welded Surface Mount Package
- > Active Area of 1.5mm / High Sensitivity
- > Spectral Range: 600nm - 1750nm
- > Hermetically Sealed

APPLICATIONS

- > High Speed Optical Communications
- > Industrial Controls
- > Optical Switches
- > LIDAR
- > Medical

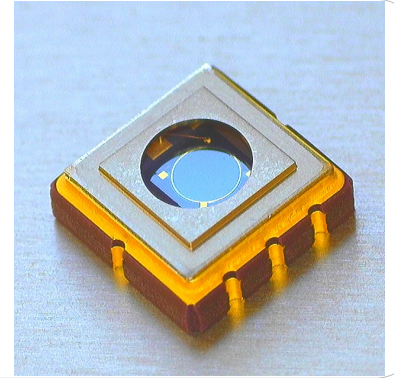

Absolute Maximum Ratings (Ta=25°C)

ITEMS	SYMBOL	RATINGS	UNIT
Active Area	Φ	1.5	mm
Operating Temperature Range	Topr	-40 to +85	°C
Storage Temperature Range	Tstg	-40 to +125	°C

Electrical & Optical Characteristics (Ta = 25°C)

ITEMS	SYMBOL	CONDITIONS	MIN	TYP	MAX	UNIT
Breakdown Voltage	VR	IR=10uA	--	--	3	V
Sensitivity Range	λ	VR=0V	600	--	1750	nm
Dark Current	ID	VR=0V	--	0.01	--	nA
Dark Current	ID	VR=1V	--	26	--	nA
Junction Capacitance	C	VR=0V	--	12	--	pF
Junction Capacitance	C	VR=1V	--	12	--	pF
Responsivity	R	λ=1650nm	--	0.74	--	A/W
Quantum Efficiency	QE	λ=1660nm	--	55	--	%
Shunt Resistance	RSH	VR=10mV	--	665	--	MΩ
Switching Times	Tr, Tf	VR=2V	--	1	--	ns
Light Current @λ=1300nm	IL	If=10mA	--	250	--	μA
Light Current @λ=1300nm	IL	If=20mA	--	500	--	μA

Package Dimensions

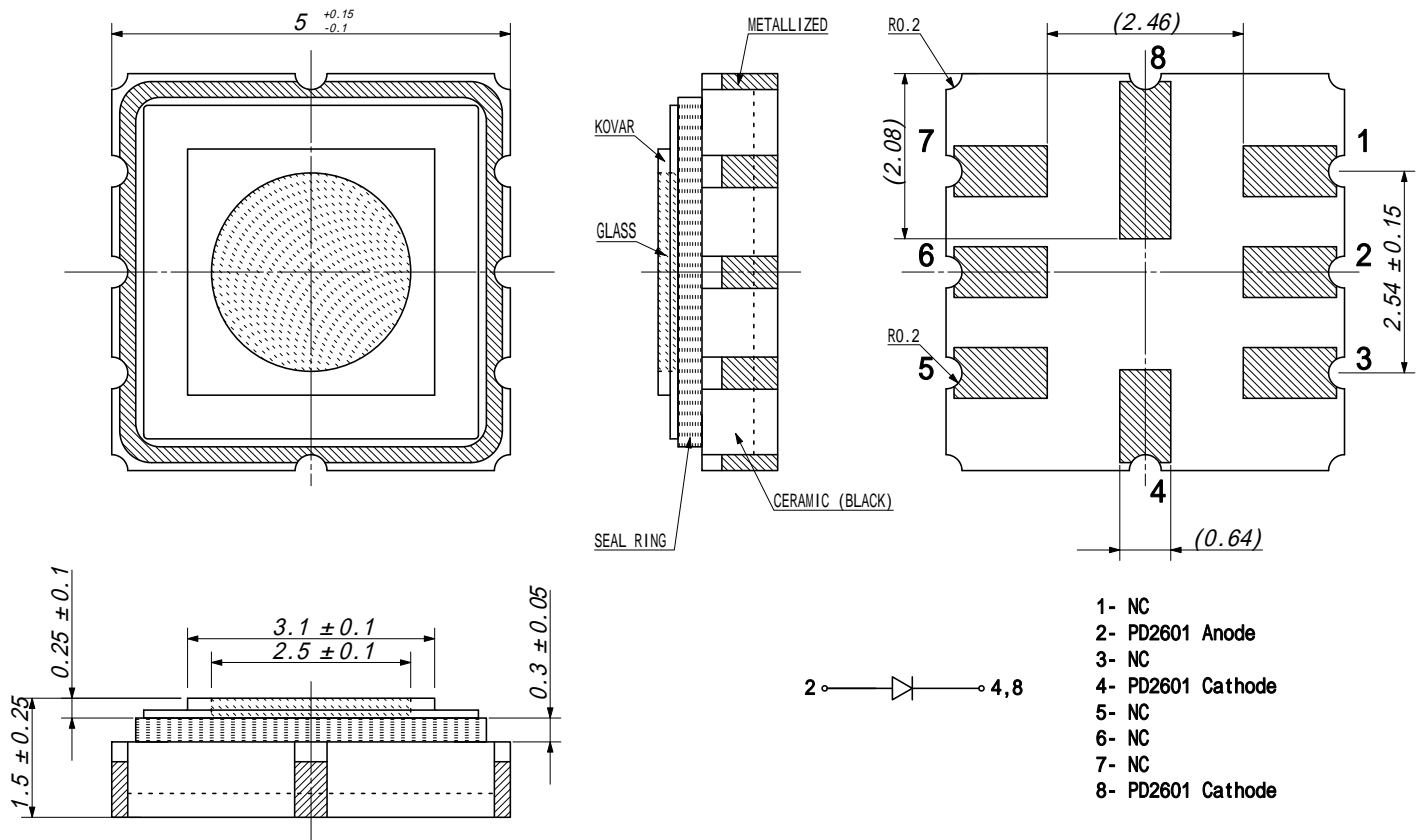

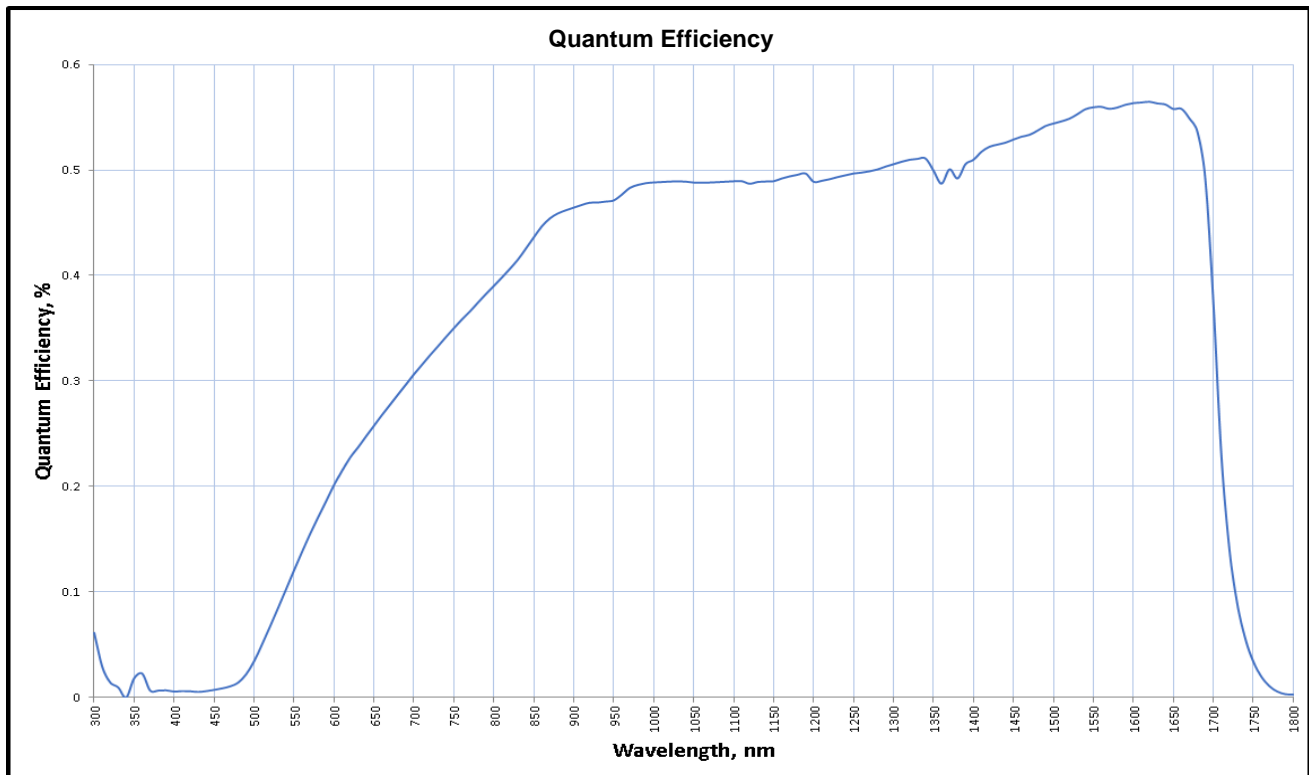
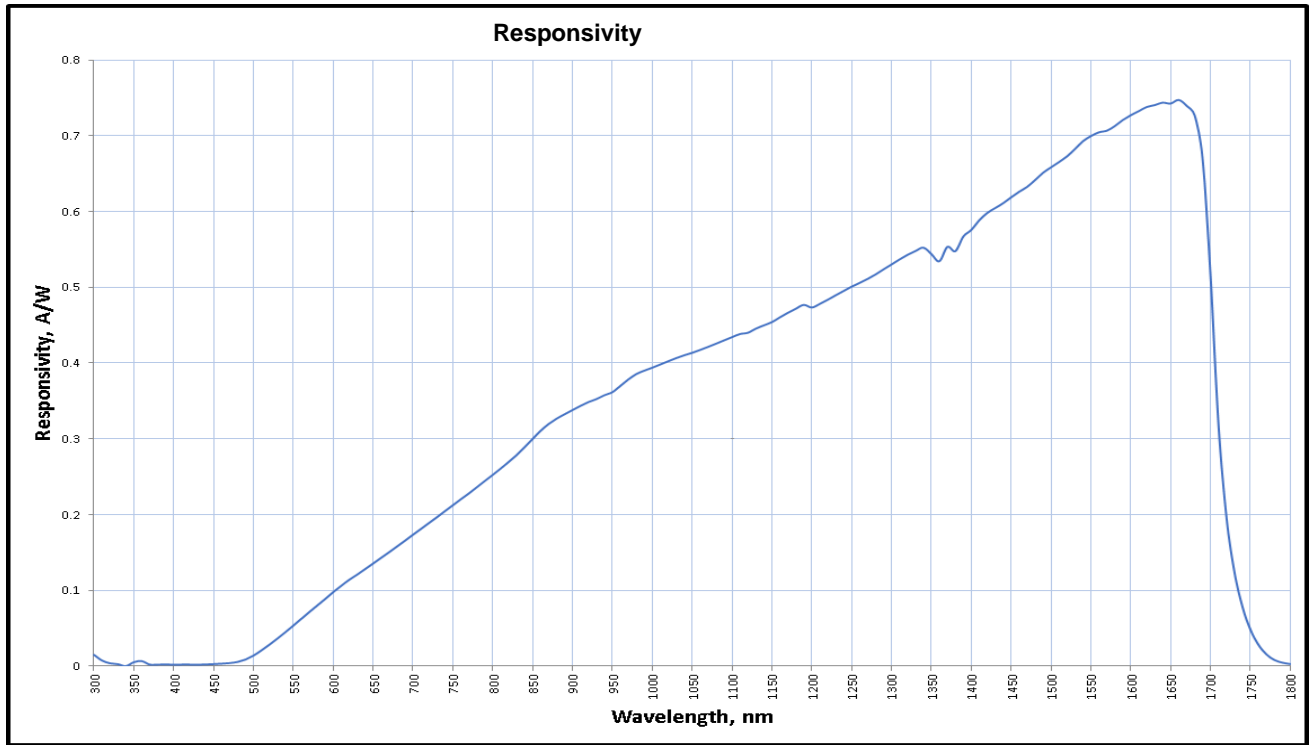

The information contained herein is subject to change without notice.

2022-12-08

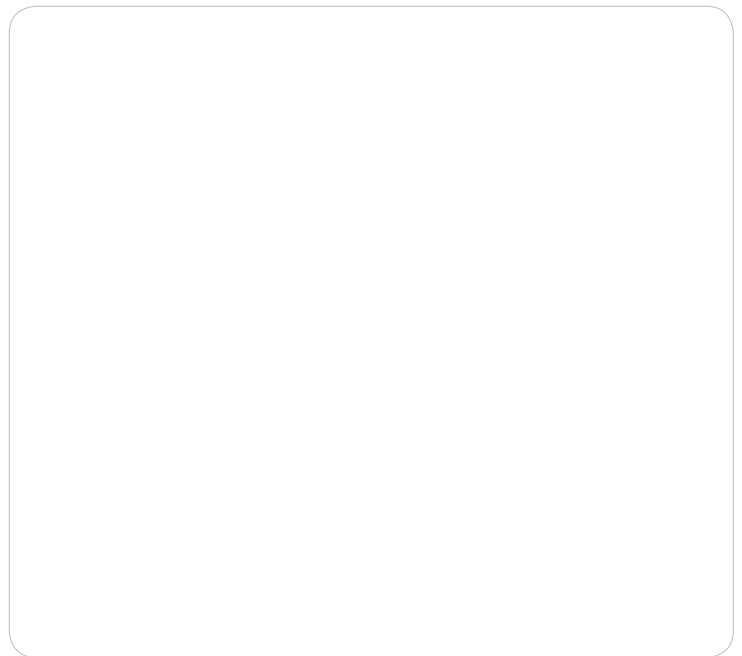
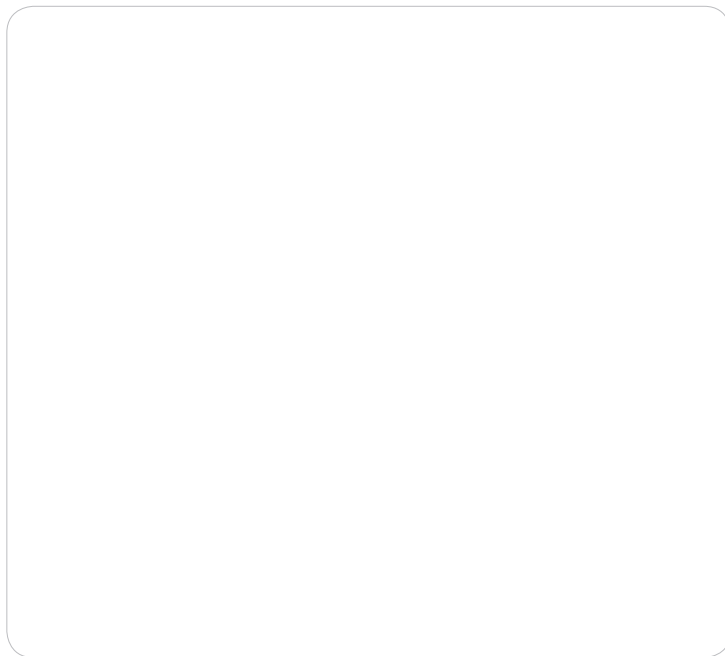
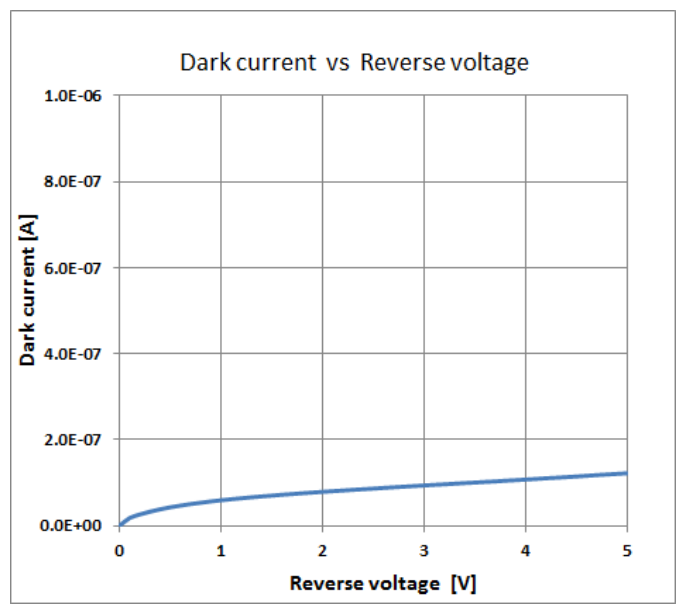
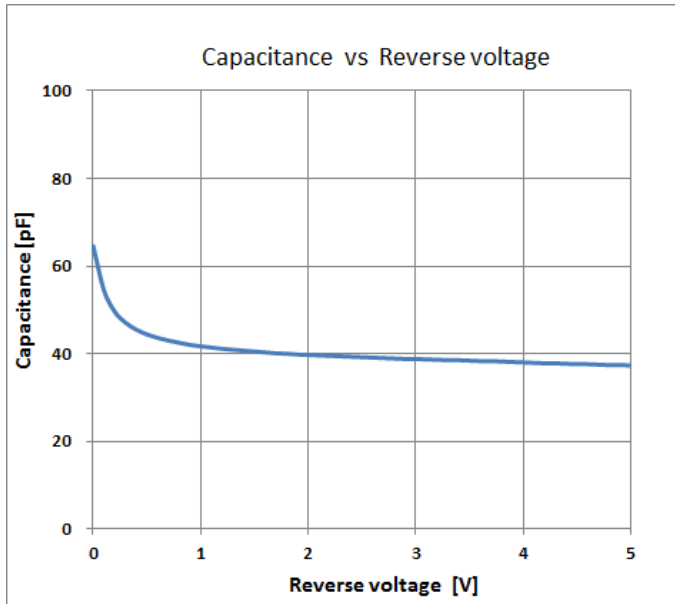

Mouser Electronics

Authorized Distributor

Click to View Pricing, Inventory, Delivery & Lifecycle Information:

[Marktech Optoelectronics:](#)

[MTSM1346SMF2-150](#)