

UNCONTROLLED DOCUMENT

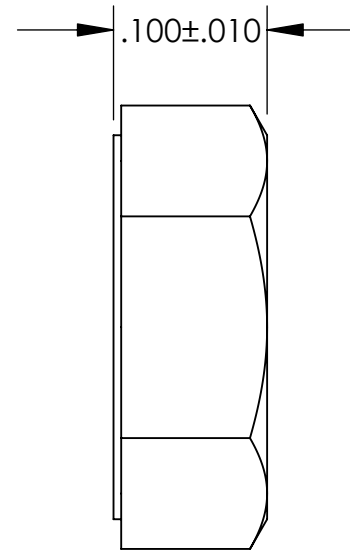
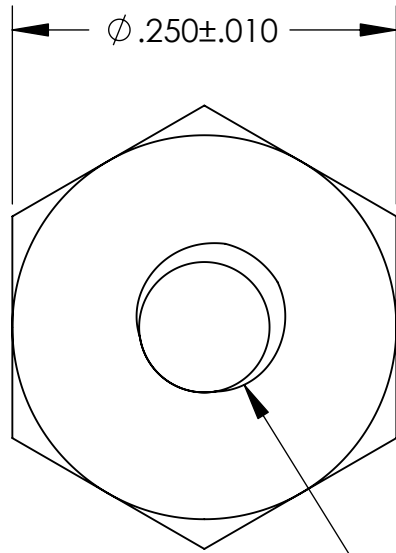

4-40 THREADS

TOLERANCES UNLESS NOTED

- $\pm .005$  ON DIMENSIONS THRU  $.625$
- $\pm .008$  ON DIMENSIONS  $.626$  THRU  $1.000$
- $\pm .010$  ON DIMENSIONS  $1.001$  THRU  $1.500$
- $\pm .015$  ON DIMENSIONS LARGER THAN  $1.500$
- $\pm .015$  ON FRACTIONAL DIMENSIONS

WE RESERVE THE RIGHT TO DISCONTINUE ITEMS, CHANGE SPECIFICATIONS OR DESIGN AT ANY TIME WITHOUT NOTICE AND WITHOUT INCURRING ANY OBLIGATIONS

PROPERTY OF		
<b>MICRO PLASTICS INC.</b>		
CATALOG DRAWING NYLON HEX NUTS MICRO P/N 0400440HN DWG. # 0400440HN FILE SERVER\ENG\WEB		
MATERIAL:		NYLON 6/6
DATE	SCALE	<b>SD</b>
	8:1	