



TAOGLAS®



Datasheet

AGGBP.SLS.25A Active GNSS Patch

Part No:
AGGBP.SLS.25A.07.0060A

Description:

25x25mm Single Stage GPS-GLONASS-GALILEO-BeiDou Embedded Active Patch Antenna Module with Front-End and Back-End SAW Filters

Features:

- Full GPS-GLONASS-GALILEO-BeiDou Coverage
- 13.0 dB One-Stage LNA
- Ceramic Patch Element
- Front-End and Back-End SAW Filters to Reduce Out of Band Interference
- Wide Input voltage +1.8V to +5V
- Cable: 60mm \varnothing 1.13
- Connector: IPEX MHFI (U.FL)
- RoHS & REACH Compliant

1. Introduction	3
2. Specifications	4
3. Antenna Characteristics	6
4. Antenna Radiation Patterns	8
5. LNA Characteristics	10
6. Mechanical Drawing	11
7. Packaging	12
<hr/>	
Changelog	13

Taoglas makes no warranties based on the accuracy or completeness of the contents of this document and reserves the right to make changes to specifications and product descriptions at any time without notice. Taoglas reserves all rights to this document and the information contained herein.

Reproduction, use or disclosure to third parties without express permission is strictly prohibited.

Copyright © Taoglas Ltd.

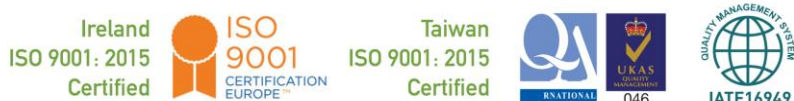

1. Introduction

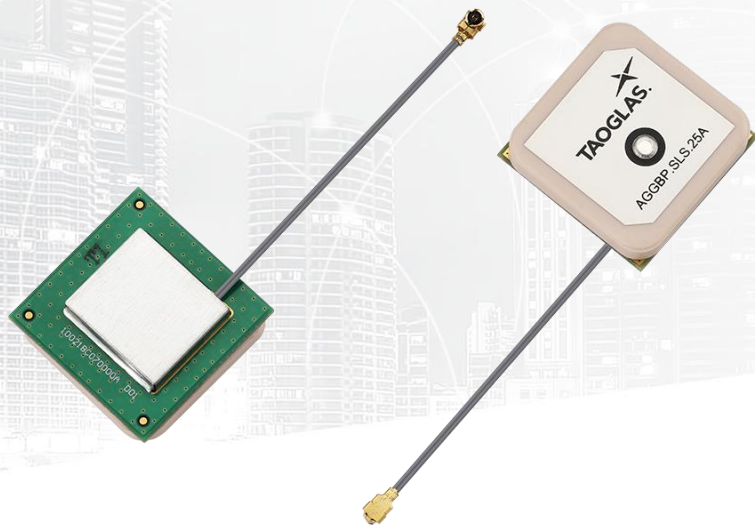

The Taoglas AGGBP.SLS.25A.07.0060A is an internal GPS/GLONASS/GALILEO/BeiDou active patch antenna with 13.0 dB LNA gain and excellent out-of-band rejection. These characteristics make the AGGBP.SLS.25A ideal for applications where the antenna will be placed near transmitters, such as cellular, Wi-Fi, Bluetooth, etc. within your enclosure.

Typical Applications Include:

- Navigation
- Wearables
- Transportation

The front-end and back-end SAW filters feature very good rejection across all non-GNSS frequencies to prevent overdriving or damaging your GPS receiver from nearby transmitters. At the commonly used LTE frequencies between 700MHz-850MHz, the AGGBP.SLS.25A features greater than 60 dB of rejection. Between 1700MHz-1910MHz, the AGGBP.SLS.25A features greater than 45 dB of rejection.

Even with the excellent out of band rejection, the AGGBP.SLS.25A maintains a very low noise figure of 2.0 dB at 1575.42MHz. This low noise figure minimizes the overall signal degradation typically caused by losses in transmission lines.

For further optimization to customer specific device environments, custom tuned patch antennas can be supplied for a MOQ. For more details please contact your regional Taoglas Customer Support team.

2. Specifications

GNSS Frequency Band							
GPS/QZSS	L1 1575.42MHz	L2 1227.6MHz	L5 1176.45MHz	L6 1278.75MHz			
	<input checked="" type="checkbox"/>	<input type="checkbox"/>	<input type="checkbox"/>	<input type="checkbox"/>			
GLONASS	L5R 1176.45MHz	L3PT 1201.5MHz	L2PT 1246MHz	L1CR 1575.42MHz	L1PT 1602MHz		
	<input type="checkbox"/>	<input type="checkbox"/>	<input type="checkbox"/>	<input checked="" type="checkbox"/>	<input checked="" type="checkbox"/>		
Galileo	E5a 1176.45MHz	E5b 1201.5MHz	E4 1215MHz	E3 1256MHz	E6 1278.75MHz	E2 1561MHz	E1 1575.42MHz
	<input type="checkbox"/>	<input type="checkbox"/>	<input type="checkbox"/>	<input type="checkbox"/>	<input type="checkbox"/>	<input type="checkbox"/>	<input checked="" type="checkbox"/>
BeiDou	B1 1561MHz	B2 1207.14MHz	B3 1268.52MHz				
	<input checked="" type="checkbox"/>	<input type="checkbox"/>	<input type="checkbox"/>				
Compass	E5B(B2)/ E6(B3) 1268.56MHz	E2(B1) 1561MHz					
	<input type="checkbox"/>	<input checked="" type="checkbox"/>					
SBAS	Omnistar 1542.5MHz	WAAS/EGN OS 1575.42MHz					
	<input type="checkbox"/>	<input checked="" type="checkbox"/>					

Electrical			
Frequency	BeiDou	GPS/GALILEO	GLONASS
	1561 MHz	1575.42 MHz	1602 MHz
Efficiency (%)	49.8	46.5	60.1
Average Gain (dBi)	-3.03	-3.33	-2.21
Peak Gain (dBi)	2.44	1.72	1.67
Impedance	50Ω		
Polarization	RHCP		
LNA Specification			
Gain (dB)	13.1 ± 1	13.8 ± 1	13.7 ± 1
NF (dB)	2.5 ± 0.2	2.0 ± 0.2	2.3 ± 0.2
Input Voltage	+1.8 to +5 VDC		
Power Consumption	3 to 4.5 mA typical		
Out-Of-Band Attenuation (dB)	10-840 MHz		> 60
	840-1500 MHz		> 50
	1700-2000 MHz		> 45
	2000-3250 MHz		> 40
	3250-5000 MHz		> 45
	5000-6000 MHz		> 30
Mechanical			
Ceramic Dimension	25.1 x 25.1 x 4mm		
Total Dimension (Including Shielding Case)	25.1 x 25.1 x 8.6mm		
Connector	IPEX MHFI (U.FL)		
Cable	Coaxial Cable ø1.13, length 60mm		
Weight	13g		
Environmental			
Operation Temperature	-40°C to 85°C		
Storage Temperature	-40°C to 85°C		
Humidity	Non-condensing 65°C 95% RH		

3. Antenna Characteristics

3.1 VSWR

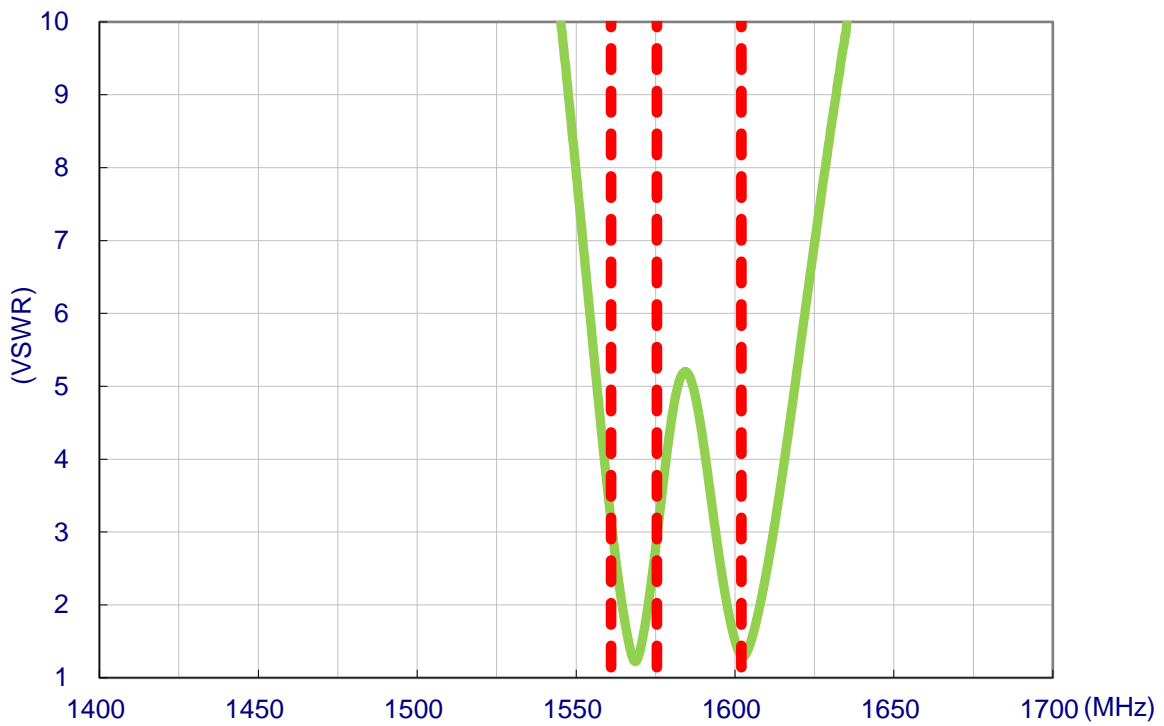

3.2 Efficiency

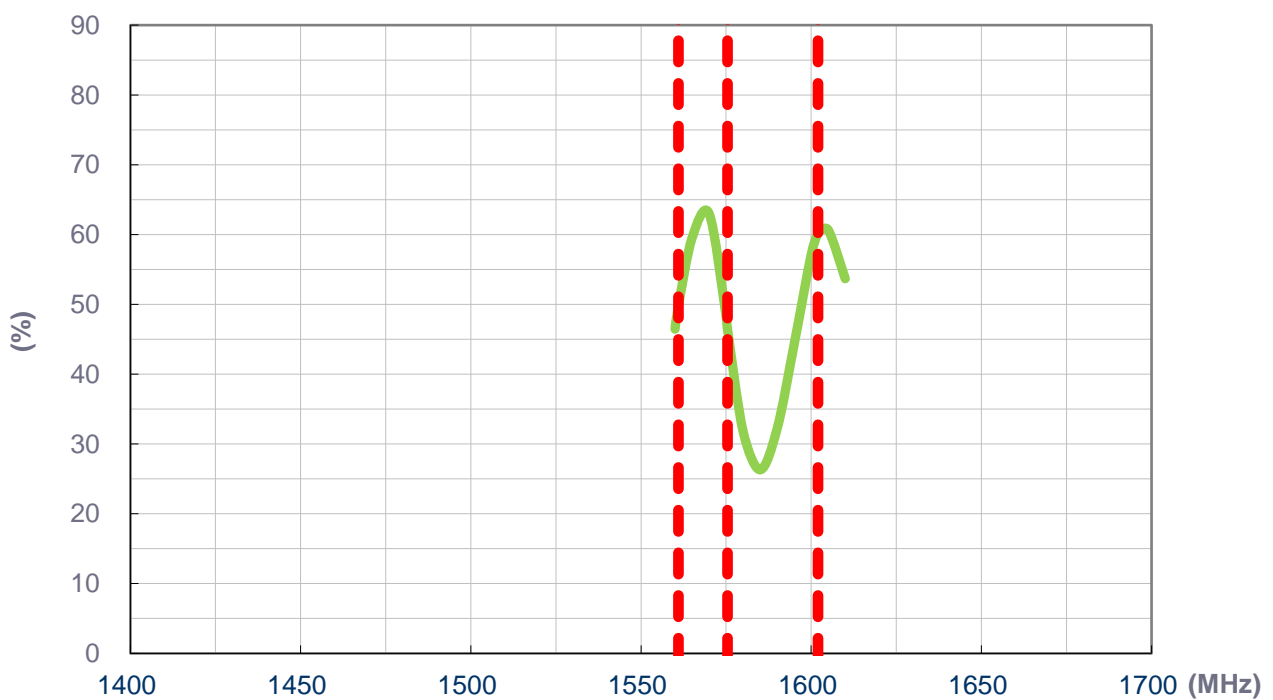

3.3 Average Gain

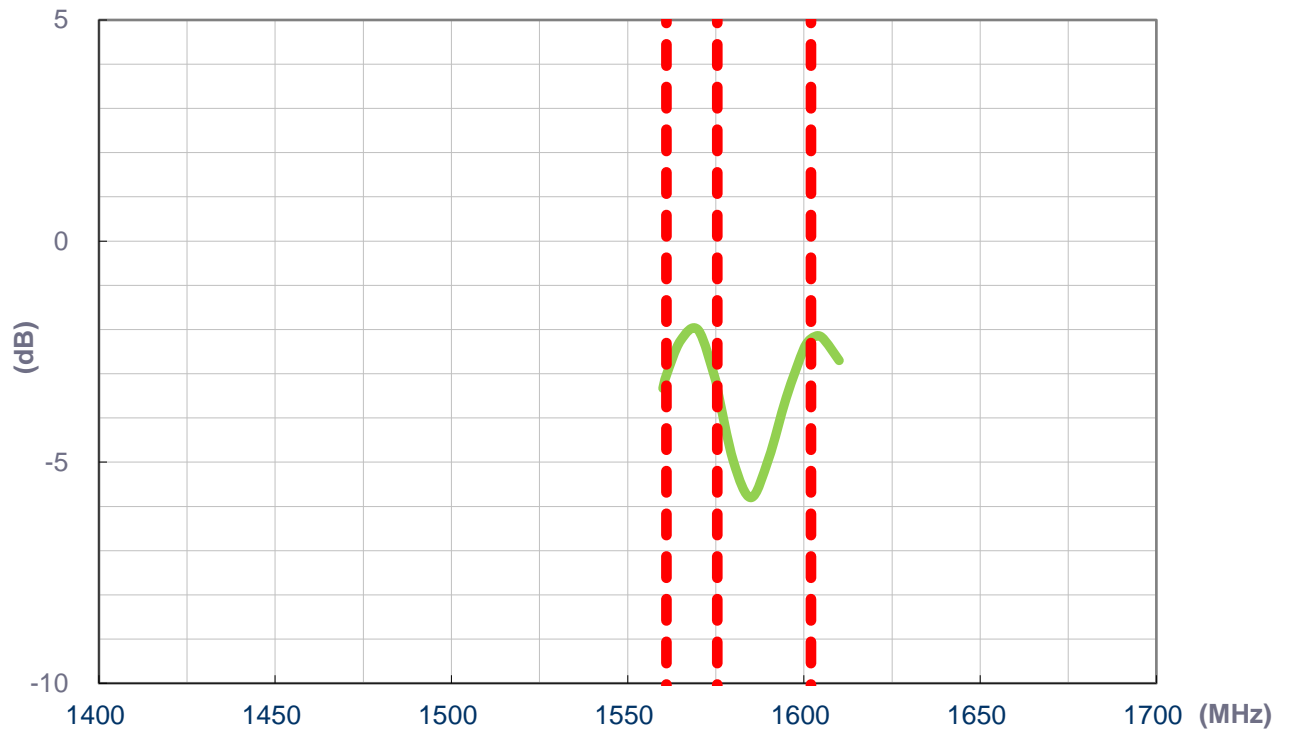

3.4 Peak Gain

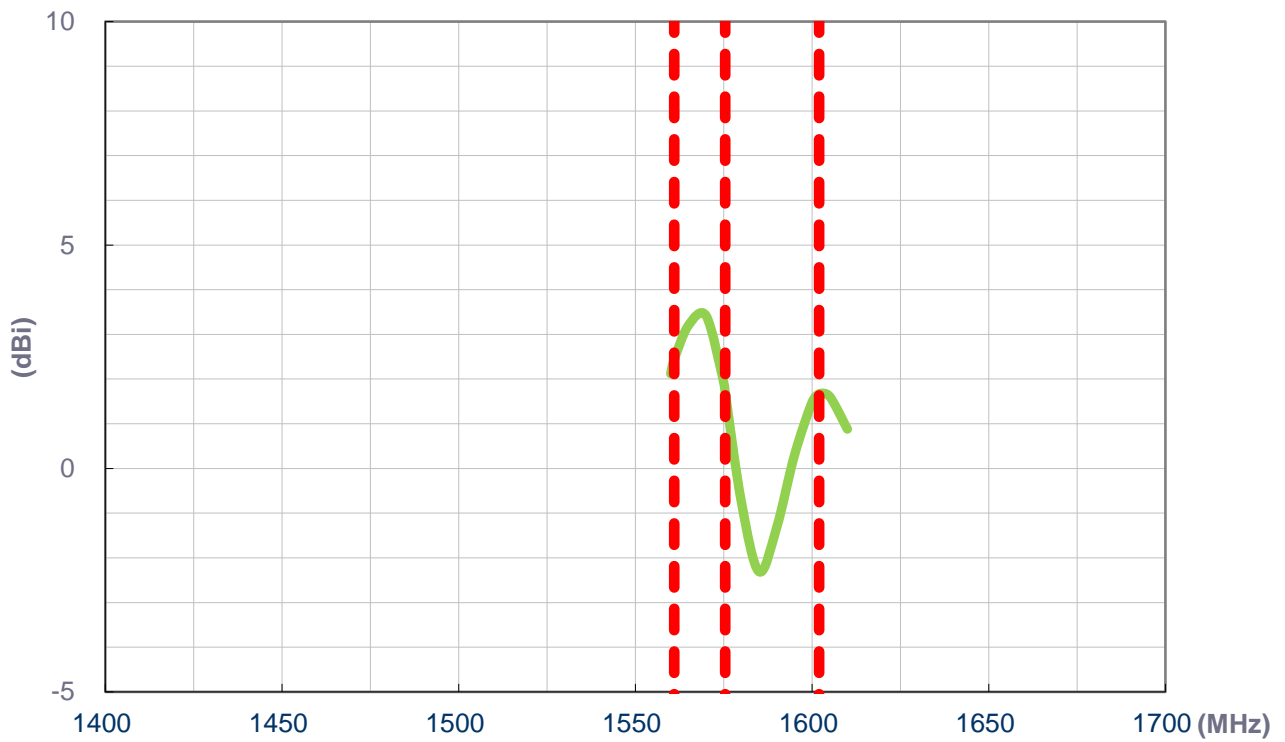

4. Antenna Radiation Patterns

4.1 Test Setup

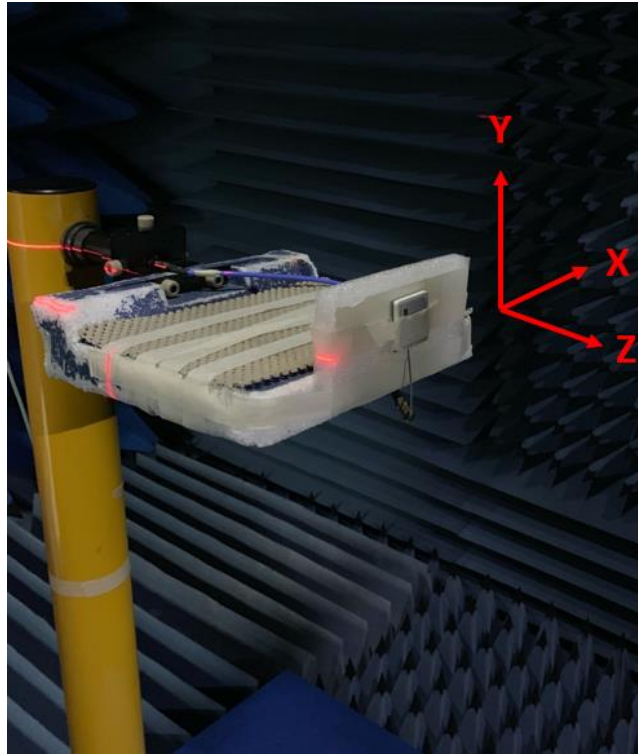

Free Space

4.2 2D & 3D Radiation Patterns

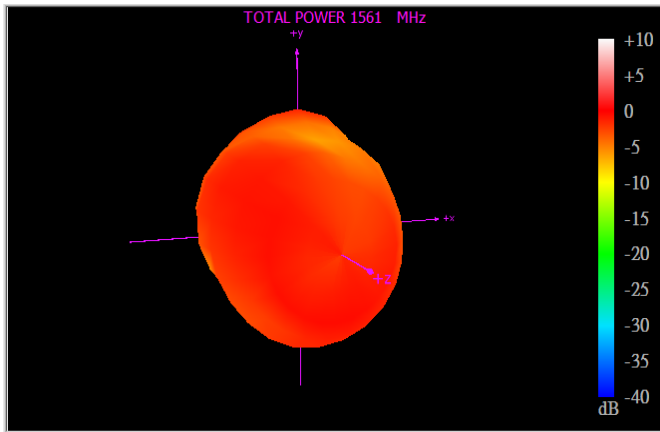

1561MHz

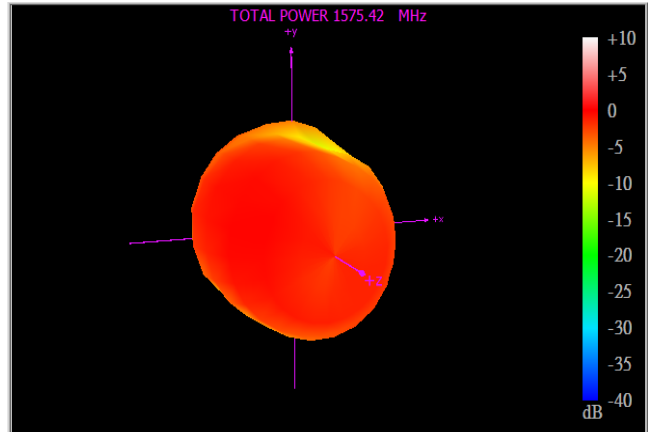

1575.42MHz

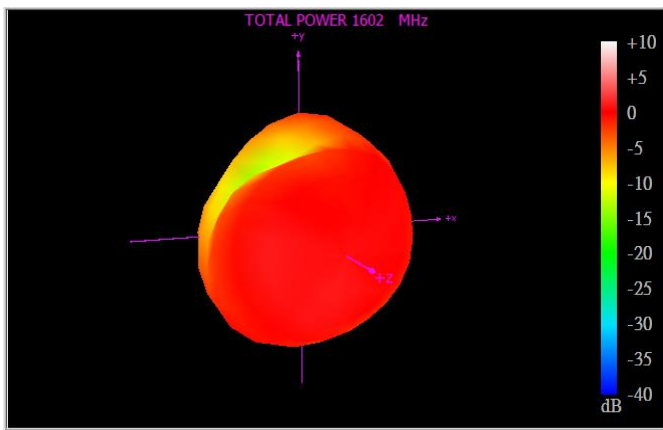

1602MHz

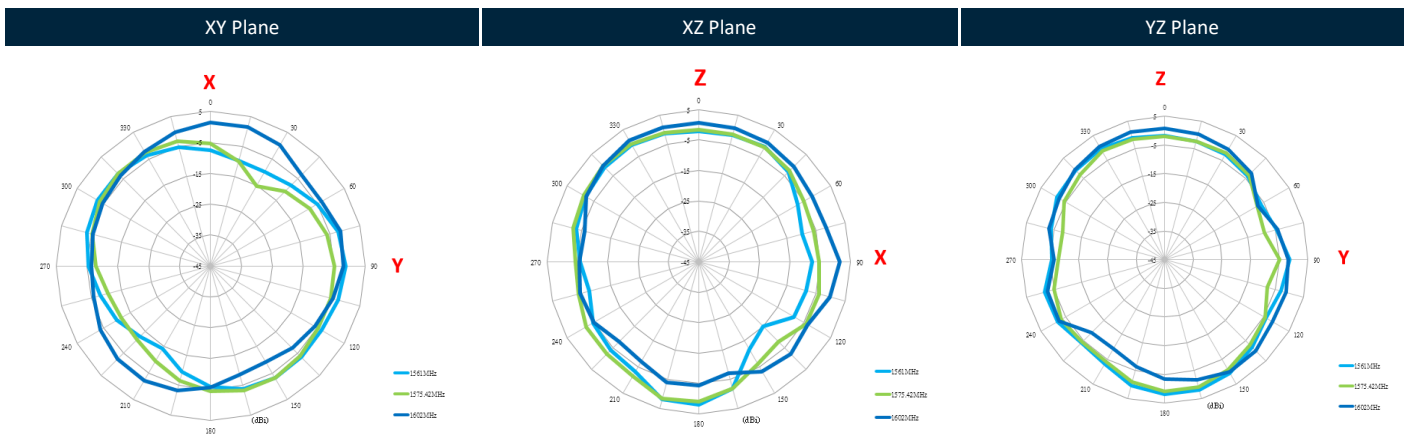

5. LNA Characteristics

5.1 LNA In-Band S21

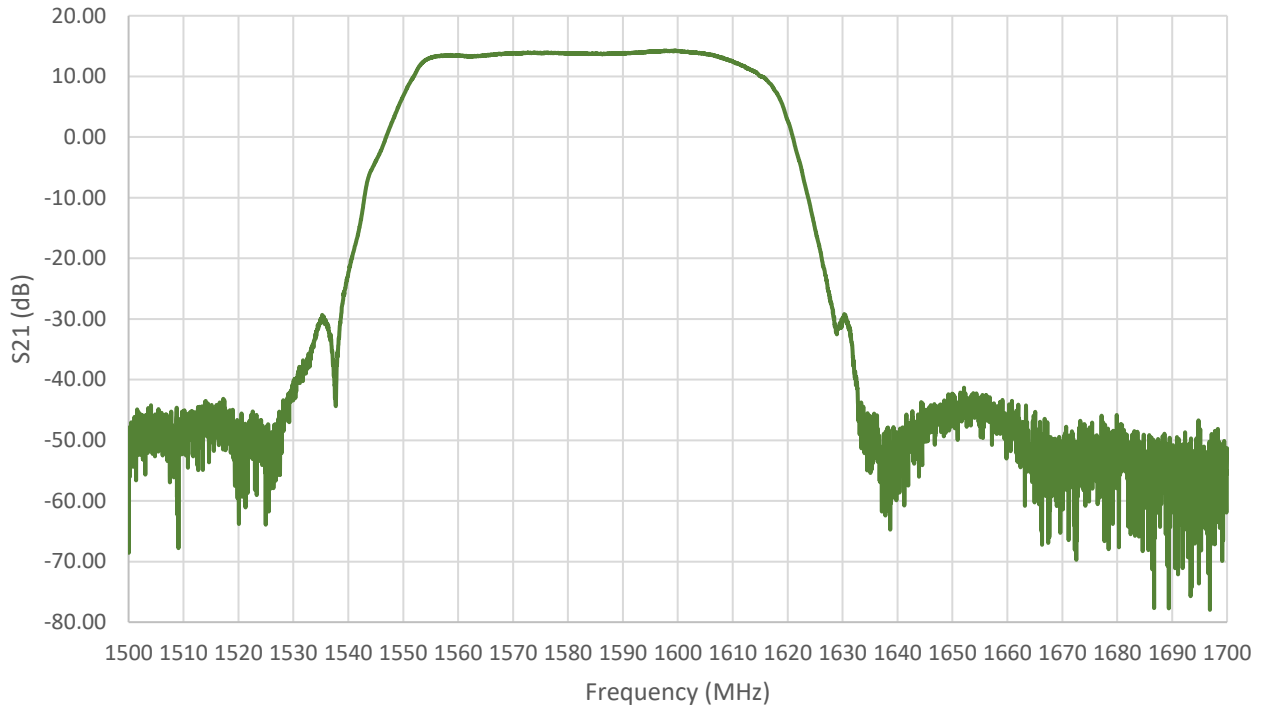

5.2 LNA Wideband S21

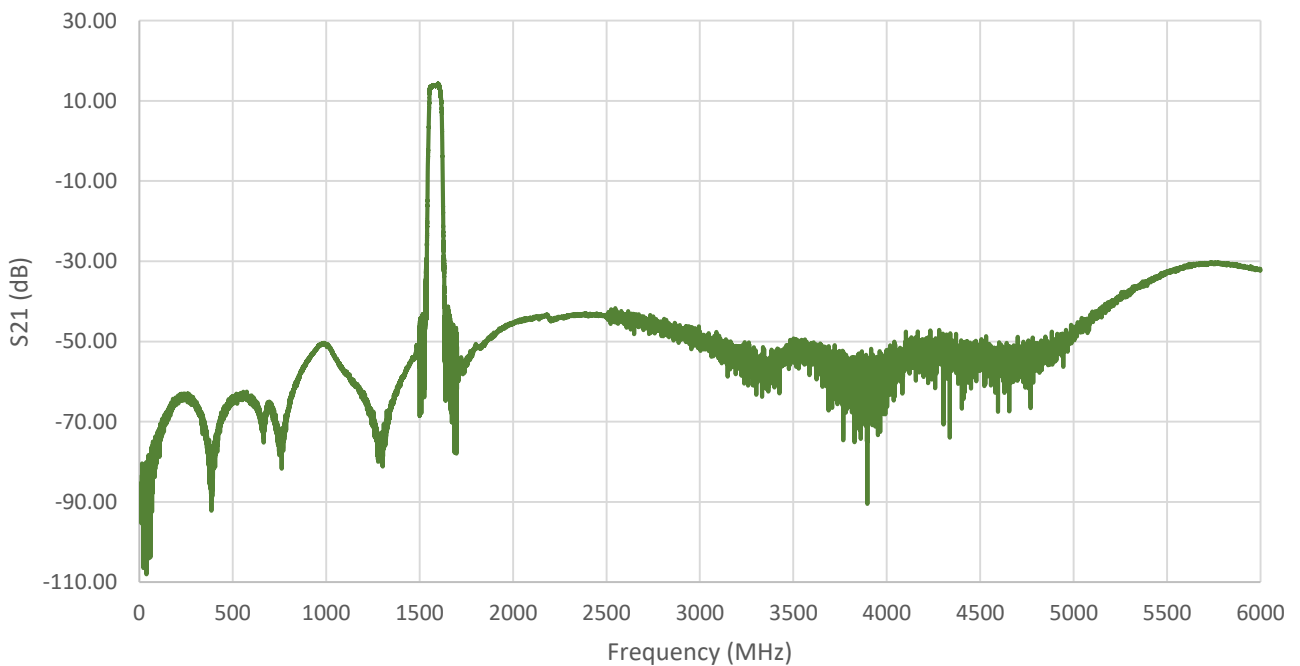

6. Mechanical Drawing (Units: mm)

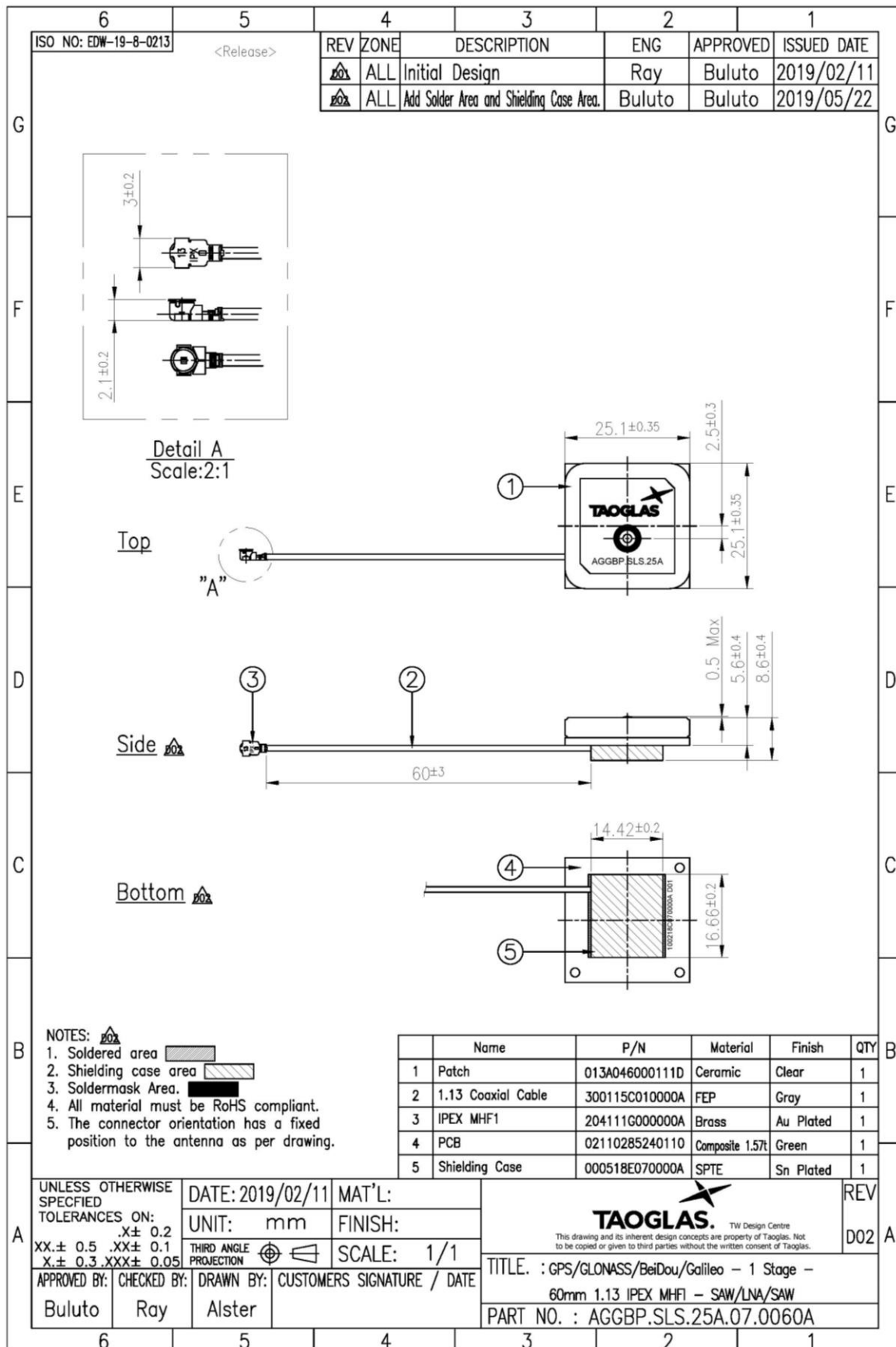

7. Packaging

30pcs AGGBP.SLS.25A.07.0060A per Tray
Weight: 615g

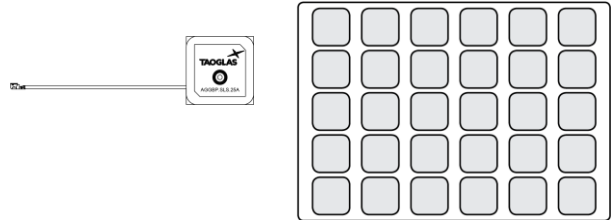

180pcs AGGBP.SLS.25A.07.0060A per PE Bag
Bag Dimensions: 365*300*25 mm
Weight: 3.69Kg



540pcs AGGBP.SLS.25A.07.0060A per carton
Dimensions: 390*320*290mm
Weight: 11.07Kg

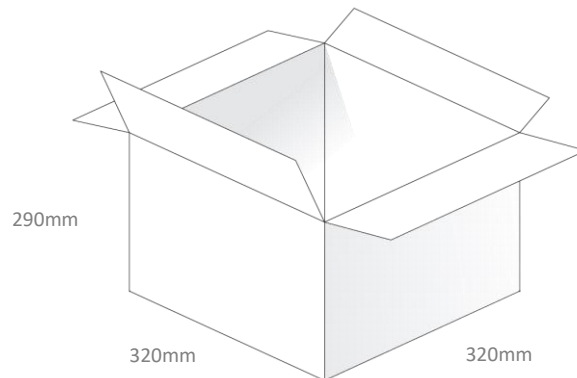

Changelog for the datasheet

SPE-17-8-042 – AGGBP . SLS.25A.07.0060A

Revision: A (Original First Release)

Date:	2019-06-20
Notes:	
Author:	Jack Conroy

Previous Revisions



TAOGLAS®

www.taoglas.com

