

## SPECIFICATION

- Part No. : **TG.10R.A.0113**
- Product Name : Triton 4G/3G/2G Terminal Antenna for Cellular Modules with Assisted GPS Hinged SMA(M)
- Feature : Dipole Terminal Antenna  
Hinged SMA(M) Connector  
Length 168mm,  $\Phi$ 13mm  
AntD© Shunt 10k Ohm Chip Resistor Inside  
RoHS compliant



## 1. Introduction

The TG.10R Triton Dipole Antenna with AntD<sup>©</sup> Resistor – is primarily designed for use with CDMA modules with assisted GPS. It does not require a ground-plane to connect to. It has a quality robust PUS housing for use with wireless terminals. The antenna has a SMA(M) connector. It can be used straight or hinged 90 degrees. The antenna has a wide-band response and can also be used for other cellular and wireless applications such as GSM, LTE, UMTS, and WI-FI.

AntD<sup>©</sup> allows connected radio products using the latest cellular modules and recommended circuits from Telit and uBlox to perform diagnostics on the antenna. This includes detection that the proper antenna is connected and that the connection isn't shorted or broken. Contact Taoglas engineering for examples on how to implement AntD<sup>©</sup> antenna diagnostics in your product.

## 2. Specification

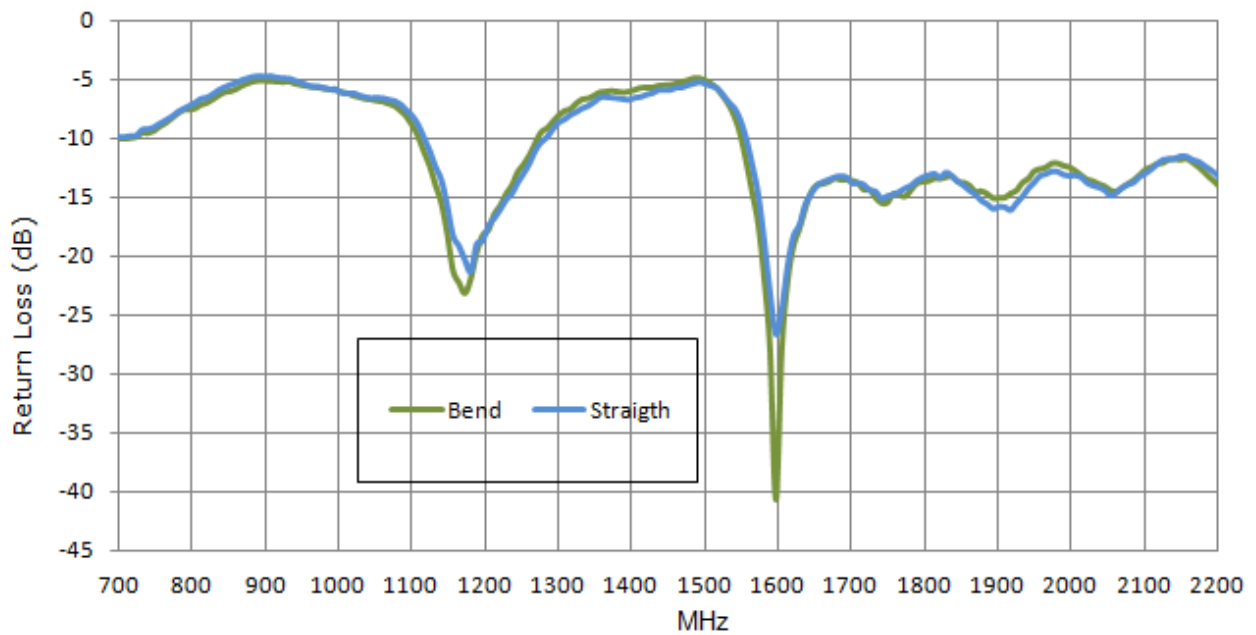
ELECTRICAL							
Frequency (MHz)	700~800	824~960	1575.42	1710 ~ 1880	1850 ~ 1990	1710 ~ 2170	2490~500
Peak Gain (dBi)							
Straight	-0.5	-0.5	-0.5	1.0	2.0	1.5	3.0
Bend	-1.5	-3.0	1.5	2.5	2.5	2.5	4.0
Efficiency							
Straight	38%	30%	40%	58%	65%	55%	75%
Bend	35%	25%	60%	69%	75%	70%	85%
Impedance	50 $\Omega$						
Integrated AntD© Resistor							
Integrated Resistor	Shunt 10K Ohm (+/- 5%) to Ground						
Polarization	Linear						
Radio Pattern	Omni						
Input Power	50 W						
MECHANICAL							
Dimensions	Length 168mm, $\Phi$ 13mm						
Connector	Hinged SMA Male						
Casing	PU						
ENVIRONMENTAL							
Temperature Range	-40°C to 85°C						
Humidity	Non-condensing 65°C 95% RH						

LTE BANDS			
Band Number	LTE / LTE-Advanced / WCDMA / HSPA / HSPA+ / TD-SCDMA		
	Uplink	Downlink	Covered
1	UL: 1920 to 1980	DL: 2110 to 2170	✓
2	UL: 1850 to 1910	DL: 1930 to 1990	✓
3	UL: 1710 to 1785	DL: 1805 to 1880	✓
4	UL: 1710 to 1755	DL: 2110 to 2155	✓
5	UL: 824 to 849	DL: 869 to 894	✓
7	UL: 2500 to 2570	DL: 2620 to 2690	✓
8	UL: 880 to 915	DL: 925 to 960	✗
9	UL: 1749.9 to 1784.9	DL: 1844.9 to 1879.9	✓
11	UL: 1427.9 to 1447.9	DL: 1475.9 to 1495.9	✗
12	UL: 699 to 716	DL: 729 to 746	✓
13	UL: 777 to 787	DL: 746 to 756	✓
14	UL: 788 to 798	DL: 758 to 768	✓
17	UL: 704 to 716	DL: 734 to 746 (LTE only)	✓
18	UL: 815 to 830	DL: 860 to 875 (LTE only)	✓
19	UL: 830 to 845	DL: 875 to 890	✓
20	UL: 832 to 862	DL: 791 to 821	✓
21	UL: 1447.9 to 1462.9	DL: 1495.9 to 1510.9	✗
22	UL: 3410 to 3490	DL: 3510 to 3590	✗
23	UL: 2000 to 2020	DL: 2180 to 2200 (LTE only)	✓
24	UL: 1625.5 to 1660.5	DL: 1525 to 1559 (LTE only)	✓
25	UL: 1850 to 1915	DL: 1930 to 1995	✓
26	UL: 814 to 849	DL: 859 to 894	✓
27	UL: 807 to 824	DL: 852 to 869 (LTE only)	✓
28	UL: 703 to 748	DL: 758 to 803 (LTE only)	✓
29	UL: -	DL: 717 to 728 (LTE only)	✓
30	UL: 2305 to 2315	DL: 2350 to 2360 (LTE only)	✓
31	UL: 452.5 to 457.5	DL: 462.5 to 467.5 (LTE only)	✗
32	UL: -	DL: 1452 - 1496	✗
35		1850 to 1910	✓
38		2570 to 2620	✓
39		1880 to 1920	✓
40		2300 to 2400	✓
41		2496 to 2690	✓
42		3400 to 3600	✗
43		3600 to 3800	✗

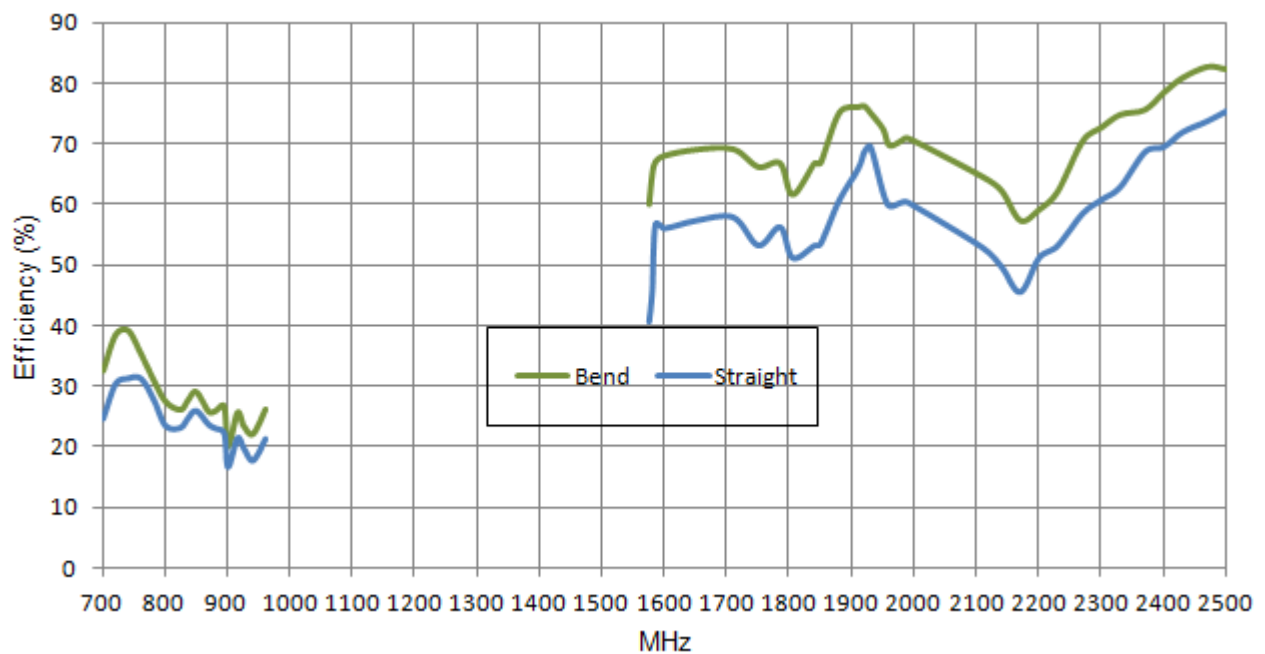
\*Covered bands represent an efficiency greater than 20%

### 3. Antenna Characteristics

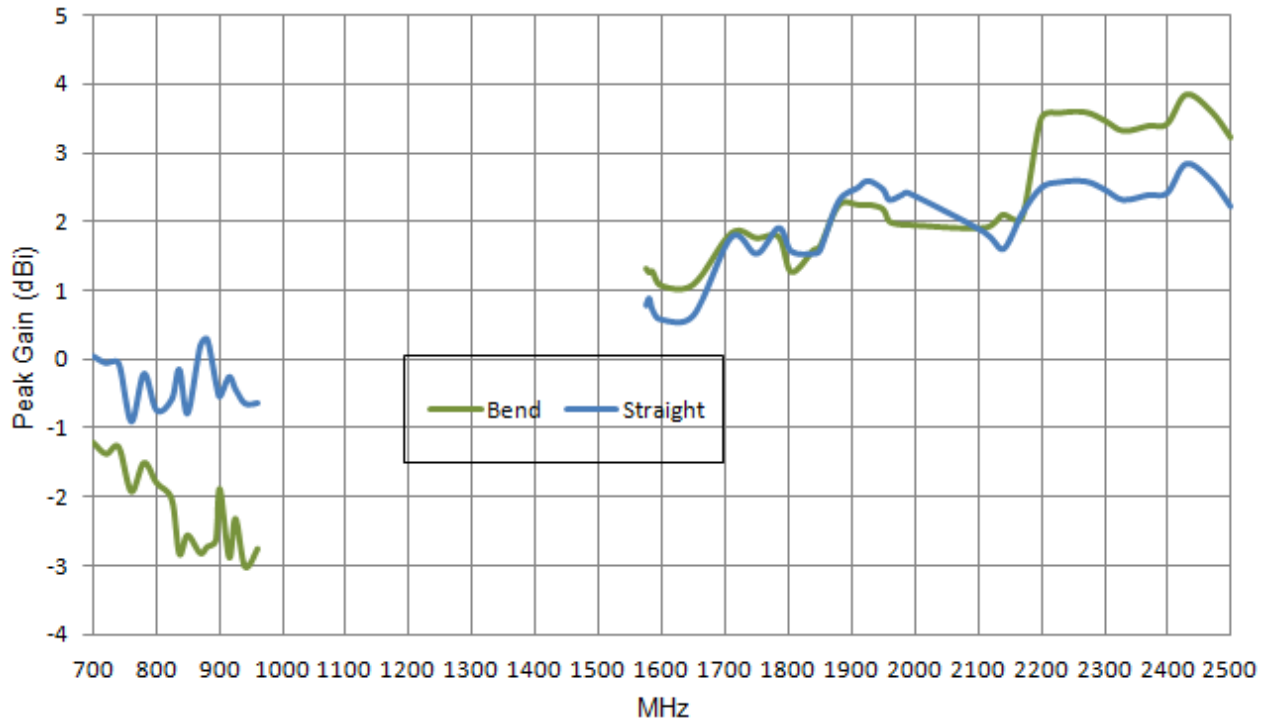
#### 3.1. Return Loss



#### 3.2. Antenna Efficiency



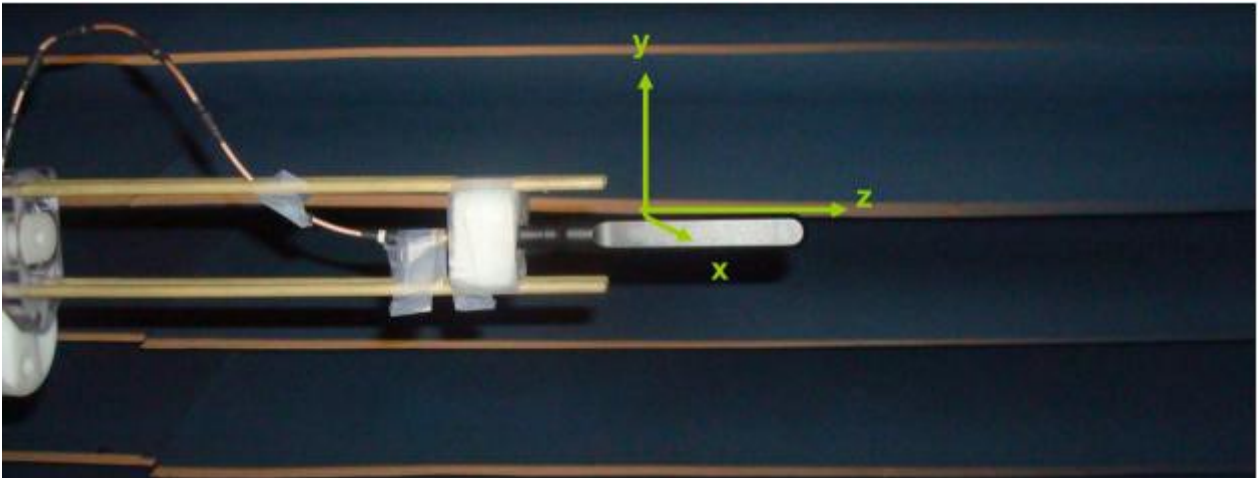
### 3.3. Peak Gain



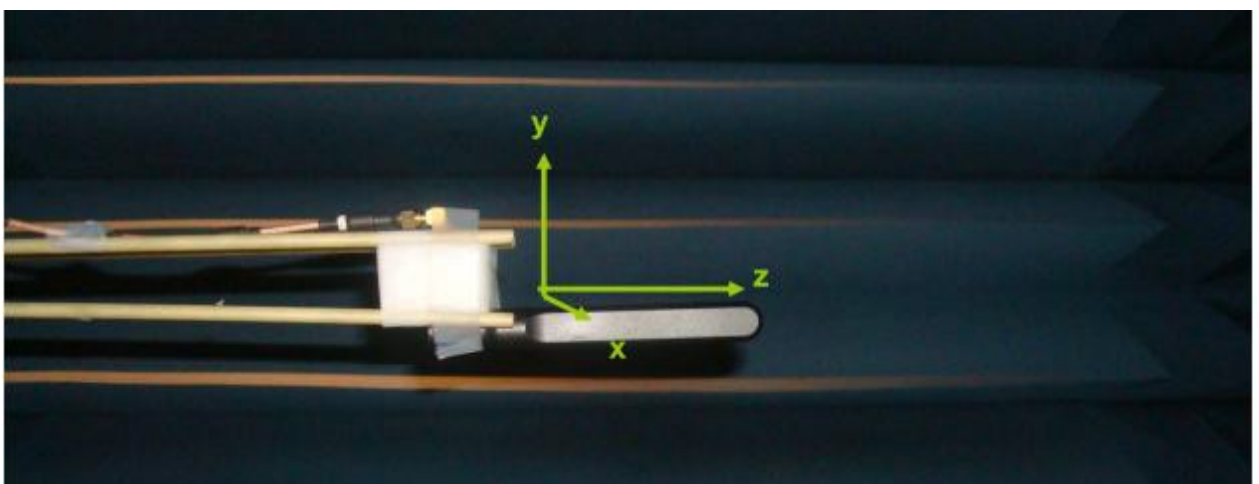
## 4. Antenna Radiation Patterns

### 4.1. Antenna setup

#### 4.1.1. Straight

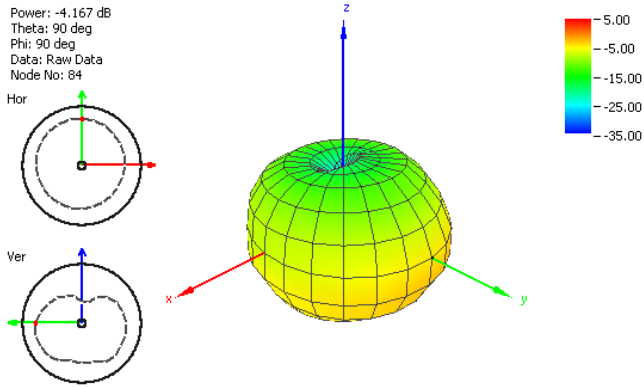


#### 4.1.2. Bend

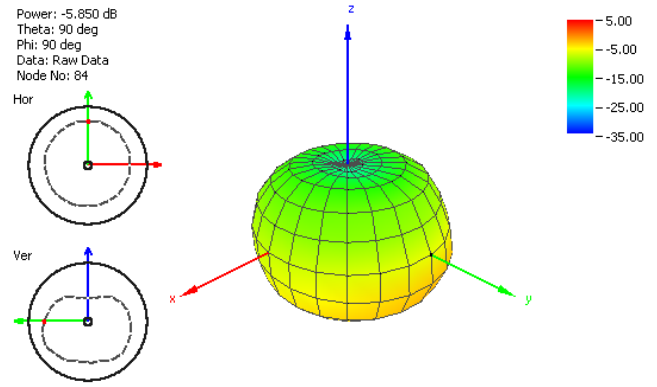


## 4.2. Radiation patterns

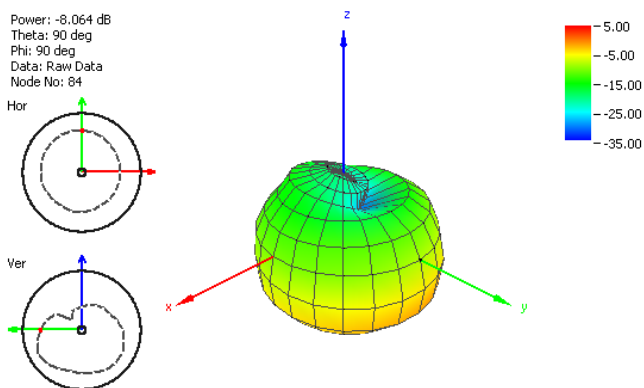
### 4.2.1. Straight (Cellular)



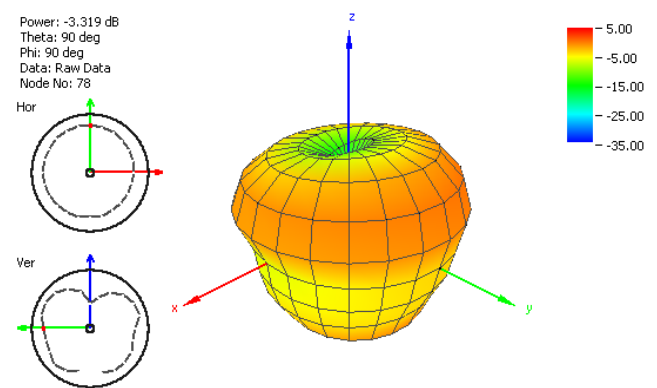
**Figure 1.** Radiation Pattern at 700 MHz



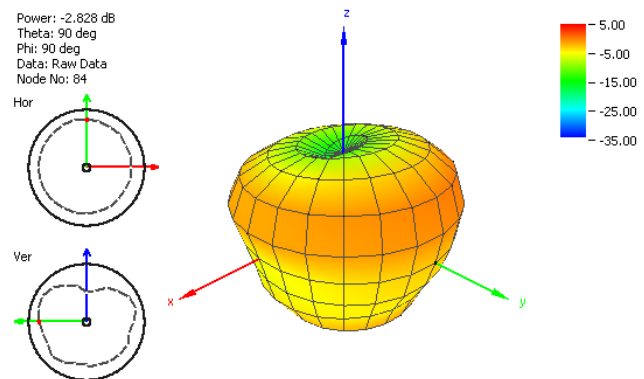
**Figure 2.** Radiation Pattern at 824 MHz



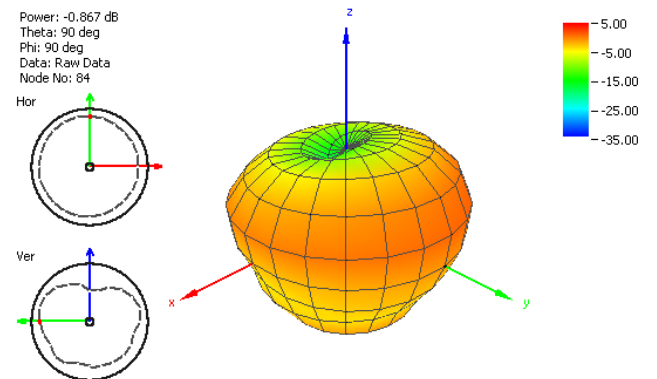
**Figure 3.** Radiation Pattern at 960 MHz



**Figure 4.** Radiation Pattern at 1700 MHz

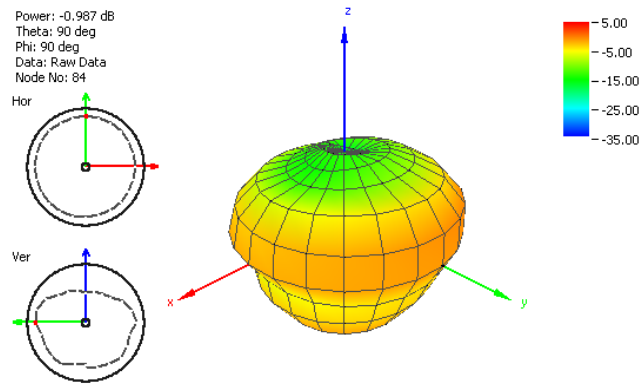


**Figure 5.** Radiation Pattern at 1800 MHz



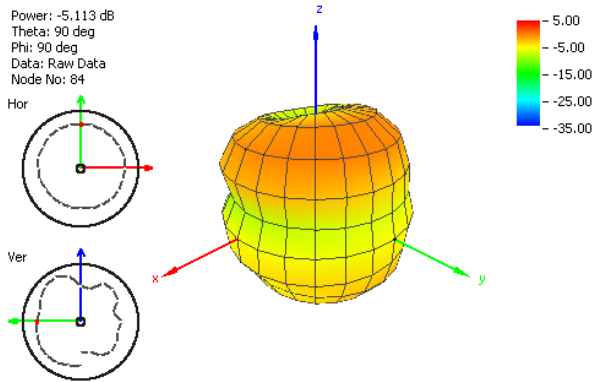
**Figure 6.** Radiation Pattern at 1910 MHz



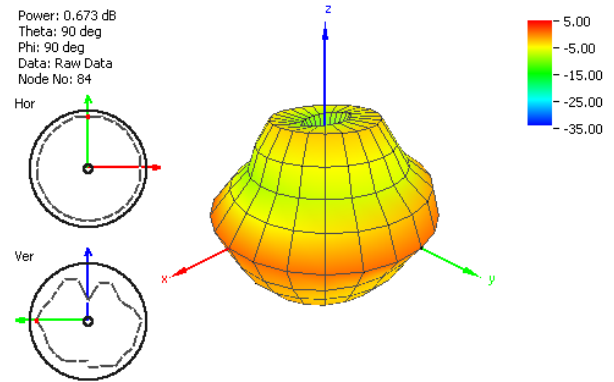


**Figure 7.** Radiation Pattern at 2170 MHz.

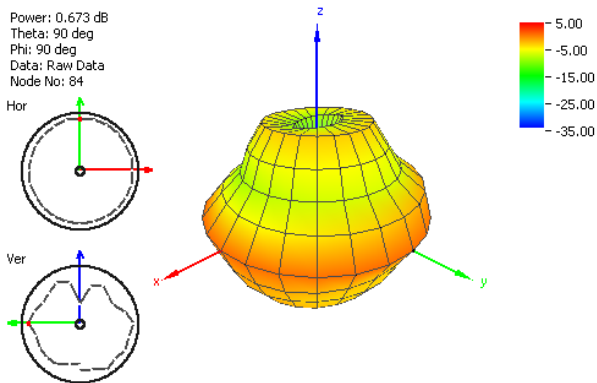
### 4.2.2. Straight (GPS & Wi-Fi)



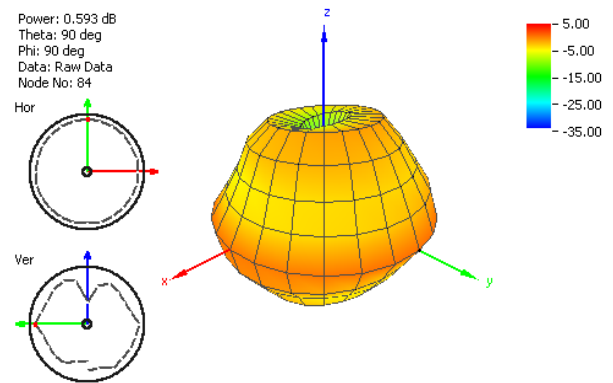
**Figure 8.** Radiation Pattern at 1575 MHz



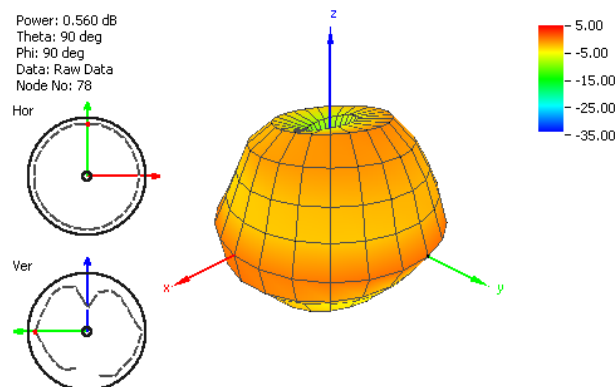
**Figure 9.** Radiation Pattern at 2400 MHz



**Figure 9.** Radiation Pattern at 2400 MHz

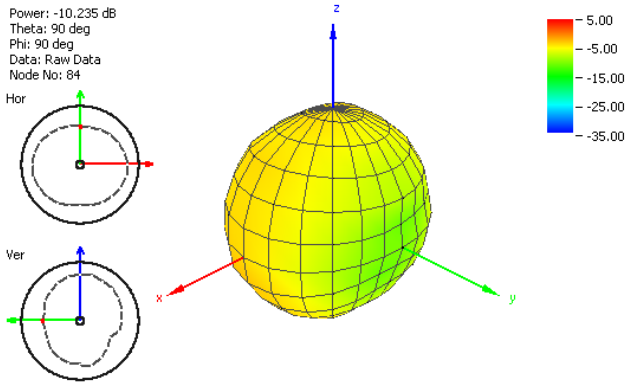


**Figure 10.** Radiation Pattern at 2460 MHz

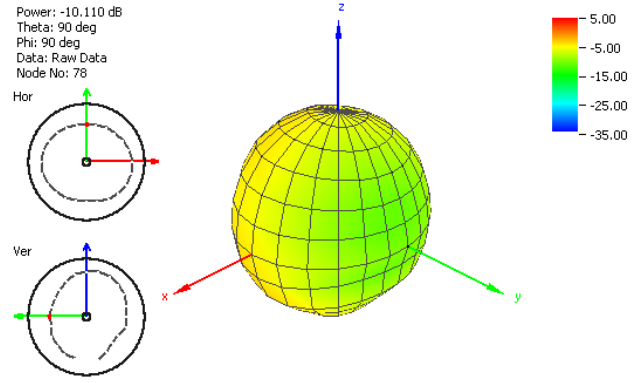


**Figure 11.** Radiation Pattern at 2460 MHz

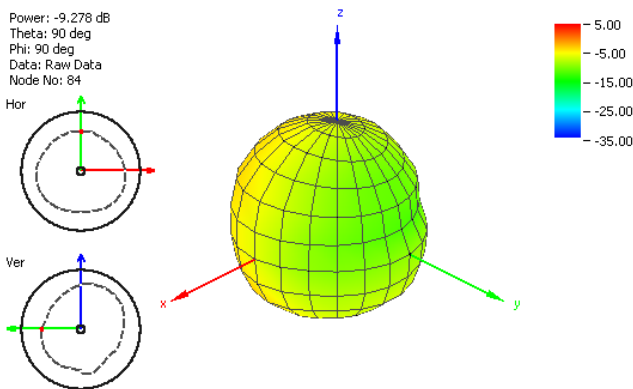
### 4.2.3. Bend (Cellular)



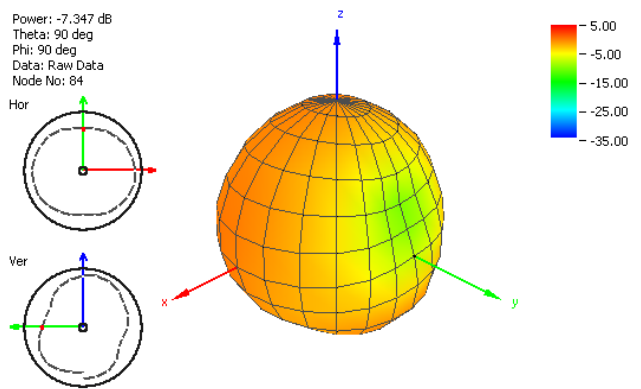
**Figure 12.** Radiation Pattern at 700 MHz



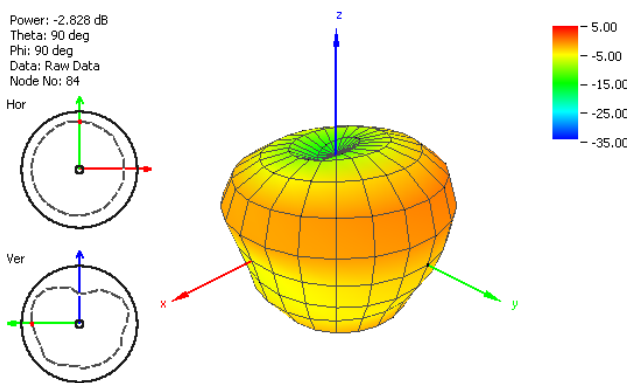
**Figure 13.** Radiation Pattern at 824 MHz



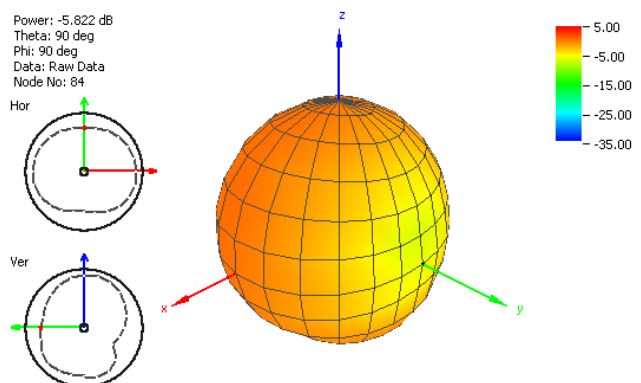
**Figure 14.** Radiation Pattern at 960 MHz



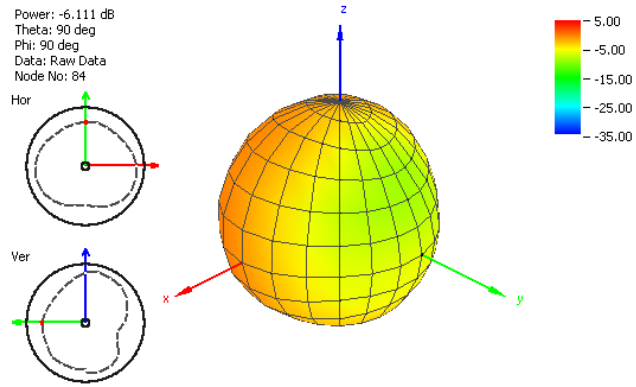
**Figure 15.** Radiation Pattern at 1700 MHz



**Figure 16.** Radiation Pattern at 1800 MHz

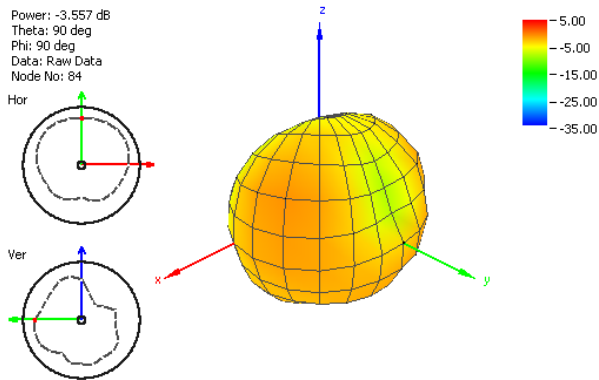


**Figure 17.** Radiation Pattern at 1900 MHz

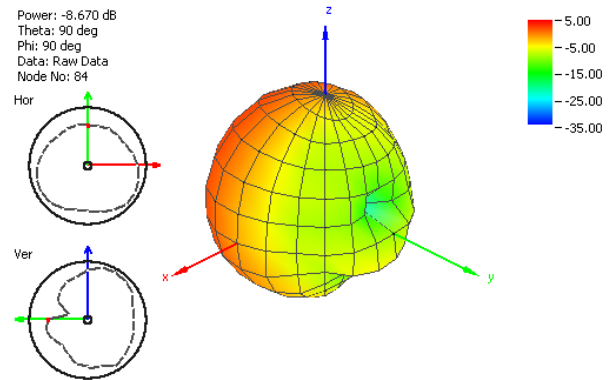


**Figure 18.** Radiation Pattern at 2200 MHz

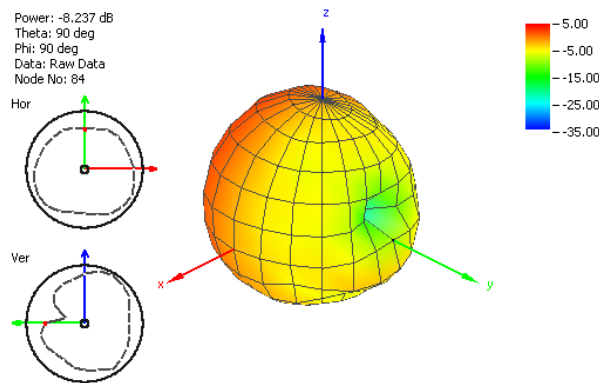
#### 4.2.4. Bend (GPS & Wi-Fi)



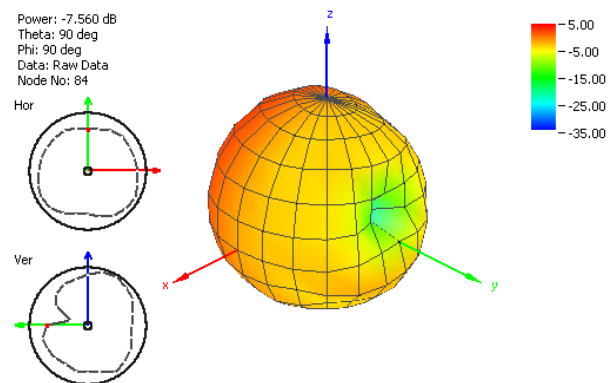
**Figure 19.** Radiation Pattern at 1575 MHz



**Figure 20.** Radiation Pattern at 2400 MHz

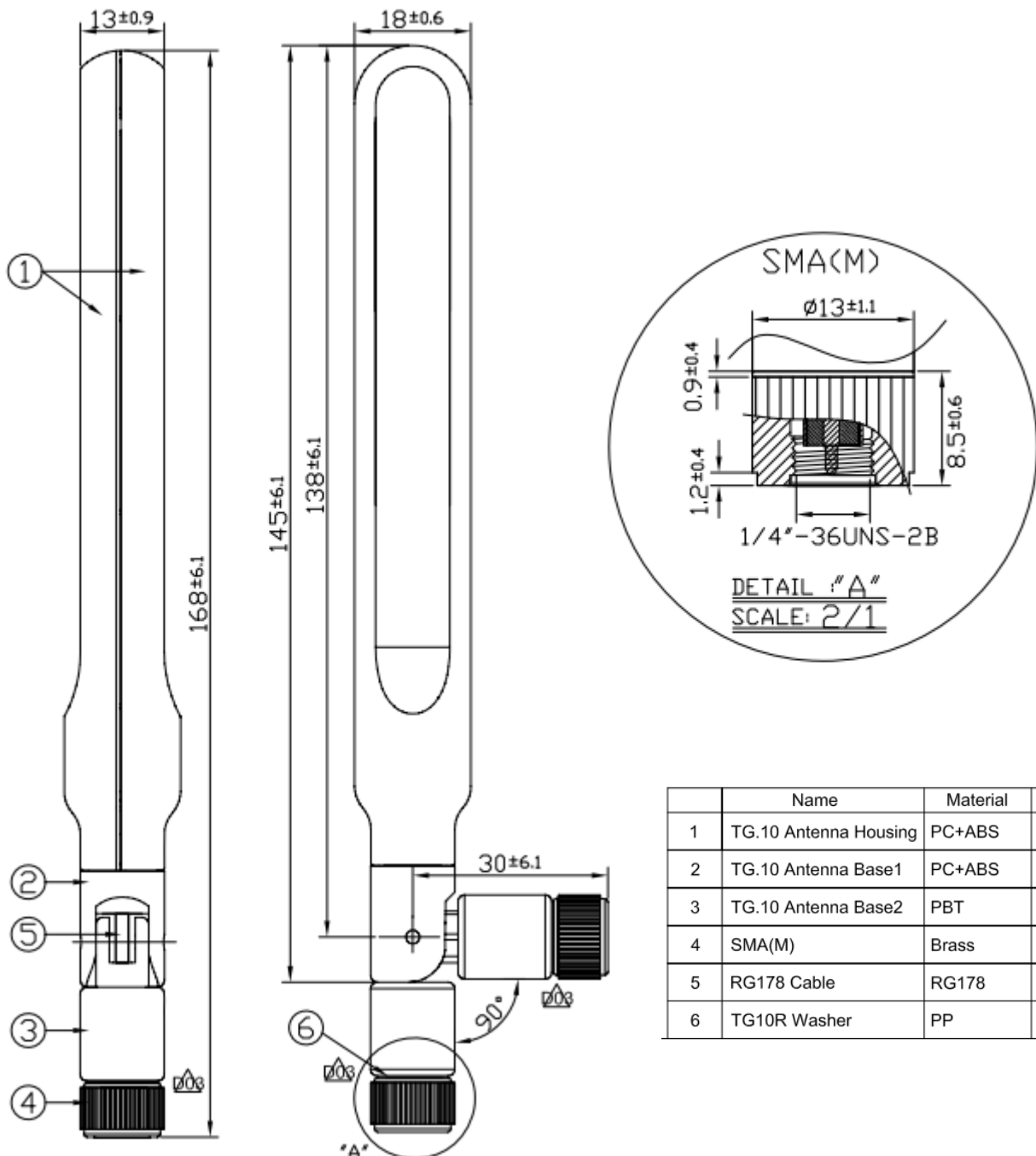


**Figure 21.** Radiation Pattern at 2460 MHz



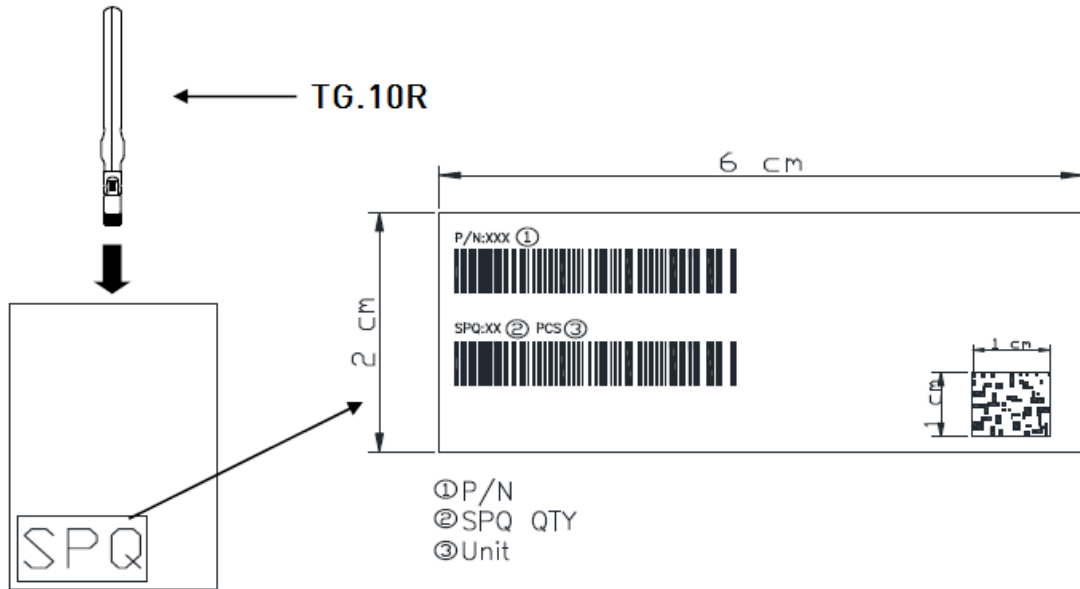
**Figure 22.** Radiation Pattern at 2500 MHz

## 5. Drawing

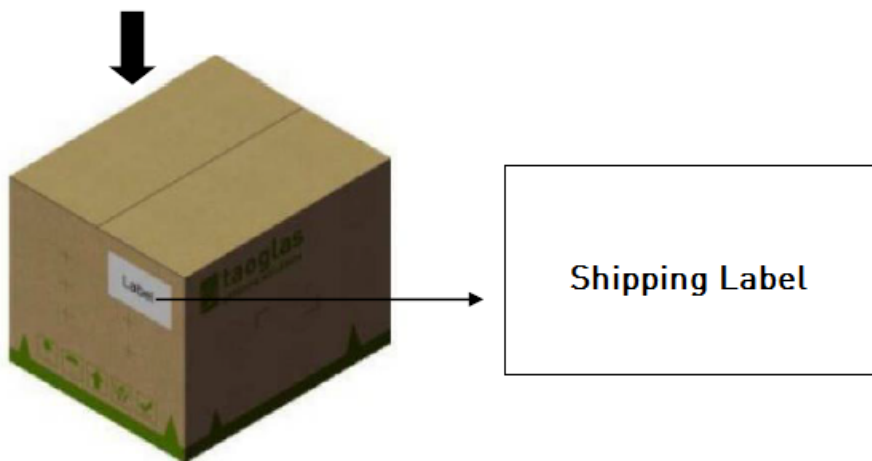


	Name	Material	Finish	QTY
1	TG.10 Antenna Housing	PC+ABS	Black	2
2	TG.10 Antenna Base1	PC+ABS	Black	1
3	TG.10 Antenna Base2	PBT	Black	1
4	SMA(M)	Brass	Black	1
5	RG178 Cable	RG178	Brown	1
6	TG10R Washer	PP	Blue	1

## 6. Packaging



50 pcs per PE Bag (240\*460mm)



300 pcs per Carton  
(400\*330\*220mm)

Taoglas makes no warranties based on the accuracy or completeness of the contents of this document and reserves the right to make changes to specifications and product descriptions at any time without notice. Taoglas reserves all rights to this document and the information contained herein.

Reproduction, use or disclosure to third parties without express permission is strictly prohibited.

Copyright © Taoglas Ltd.