



# TAOGLAS®



# Datasheet

## Hercules 2-in-1

**Part No:**

*MA520.A.BC.008*

**Description:**

Hercules 2-in-1 Cellular and Wi-Fi Permanent Mount with 2m of RG-316 with SMA(M) for Cellular and RP-SMA(M) Wi-Fi

**Features:**

- Cellular 4G/3G/2G
- Dual Band Wi-Fi 2.4 GHz / 5.8 GHz
- Low Profile and Vandal Proof
- Heavy Duty Permanent Mount
- Cellular: 2m RG-316 SMA(M)
- Wi-Fi: 2m RG-316 RP-SMA(M)
- RoHS & REACH Compliant

1. Introduction	3
2. Specifications	5
3. Antenna Characteristics	6
4. Radiation Patterns	11
5. Mechanical Drawing	25
6. Packaging	26
7. Installation Guidelines	27
8. Application Note	28
<hr/>	
Changelog	31

Taoglas makes no warranties based on the accuracy or completeness of the contents of this document and reserves the right to make changes to specifications and product descriptions at any time without notice. Taoglas reserves all rights to this document and the information contained herein. Reproduction, use or disclosure to third parties without express permission is strictly prohibited.



# 1. Introduction



The MA520 Hercules 2-in-1 Cellular and 2.4/5.8GHz Antenna is the smallest package high performance screw-mount (permanent mount) antenna available, for external use on vehicles and outdoor assets worldwide. Everything is in the one housing reducing the need for multiples antenna installations. This is the ideal antenna for 3G gateway routers that provide Wi-Fi hotspots.

Typical Applications Include:

- Smart Metering
- Routers and Gateways
- Connected Enterprise

It has been designed for heavy duty work with extra thick threads; with durable UV-resistant, ABS housing is resistant to vandalism and direct attack. At only 29mm high and 49mm in diameter this antenna enables covert operation and its quality is proven by growing adoption by many of the world's largest wireless brands. The standard cable length is 2 meters. The Hercules MA520's exceptional design means it can work equally well mounted on or without ground-plane.

The cables and connectors are fully customizable, for further information please contact your regional Taoglas customer support team.

## 2. Specifications

Cellular Electrical									
Band	Frequency (MHz)		Efficiency (%)	Average Gain (dB)	Peak Gain (dBi)	Max Input Power	Impedance	Polarization	Radiation Pattern
5G NR/4G Band 5,8,18,19,20,26,27,28, 29	700~960	Free space	37.4	-4.3	0	10W	50 Ω	Linear	Omni
		30*30cm Ground Plane	32.2	-4.9	0.7				
4G/3G Band 1,2,3,4,9,23,25,35,39,66	1710~2200	Free space	32	-4.9	0.9				
		30*30cm Ground Plane	30.9	-5.1	2.4				
4G/3G Band 7,38,41	2490~2690	Free space	7.9	-11	-4.2				
		30*30cm Ground Plane	10.3	-9.9	-2.9				
5G NR/4G Band 22,42,43,48,77,78,79	3300~3800	Free space	9.1	-10.4	-2.2				
		30*30cm Ground Plane	15.2	-8.2	-0.3				
LTE5200/ Wi-Fi 5800	5150~5925	Free space	13.6	-8.7	1.7				
		30*30cm Ground Plane	21.2	-6.7	1.1				

Wi-Fi Electrical							
Band	Frequency (MHz)	Efficiency (%)	Peak Gain (dBi)	Max Power Input	Impedance	Polarization	Radiation Pattern
2.4GHz Wi-Fi	2400~2500	25	2.1	10W	50 Ω	Linear	Omni
5.8GHz Wi-Fi	5150~5850	20	-3.2				

Mechanical	
Dimensions	29*Ø49mm
Cable	2m RG-316
Connector	Cellular: SMA(M) Straight Wi-Fi: Reverse Polarity SMA(M) Straight
Thread Diameter	18mm
Casing	UV Resistant ABS
Weatherproof Gasket	CR4305 Foam with 3M9448B Double sided adhesive
Sealant	Rubber Stopper
Base Thread	Nickel Plated

Environmental	
Corrosion	5% NaCl for 96hrs
Temperature Range	-40°C to +85°C
Thermal Shock	100 cycles -40°C to +85°C
Humidity	Non-condensing 65°C 95% RH
Shock (Drop Test)	1m drop on concrete 6 axes
RoHS & REACH Compliant	Yes

5G/4G Bands			
Band Number	5G NR / FR1 / LTE / LTE-Advanced / WCDMA / HSPA / HSPA+ / TD-SCDMA		
	Uplink	Downlink	Covered
1	UL: 1920 to 1980	DL: 2110 to 2170	✓
2	UL: 1850 to 1910	DL: 1930 to 1990	✓
3	UL: 1710 to 1785	DL: 1805 to 1880	✓
4	UL: 1710 to 1755	DL: 2110 to 2155	✓
5	UL: 824 to 849	DL: 869 to 894	✓
7	UL: 2500 to 2570	DL: 2620 to 2690	✓
8	UL: 880 to 915	DL: 925 to 960	✓
9	UL: 1749.9 to 1784.9	DL: 1844.9 to 1879.9	✓
11	UL: 1427.9 to 1447.9	DL: 1475.9 to 1495.9	✗
12	UL: 699 to 716	DL: 729 to 746	✗
13	UL: 777 to 787	DL: 746 to 756	✗
14	UL: 788 to 798	DL: 758 to 768	✓
17	UL: 704 to 716	DL: 734 to 746	✗
18	UL: 815 to 830	DL: 860 to 875	✓
19	UL: 830 to 845	DL: 875 to 890	✓
20	UL: 832 to 862	DL: 791 to 821	✓
21	UL: 1447.9 to 1462.9	DL: 1495.9 to 1510.9	✗
22	UL: 3410 to 3490	DL: 3510 to 3590	✓
23	UL: 2000 to 2020	DL: 2180 to 2200	✓
24	UL: 1625.5 to 1660.5	DL: 1525 to 1559	✓
25	UL: 1850 to 1915	DL: 1930 to 1995	✓
26	UL: 814 to 849	DL: 859 to 894	✓
27	UL: 807 to 824	DL: 852 to 869	✓
28	UL: 703 to 748	DL: 758 to 803	✓
29	UL: -	DL: 717 to 728	✗
30	UL: 2305 to 2315	DL: 2350 to 2360	✗
31	UL: 452.5 to 457.5	DL: 462.5 to 467.5	✗
32	UL: -	DL: 1452 – 1496	✗
35		1850 to 1910	✓
38		2570 to 2620	✓
39		1880 to 1920	✓
40		2300 to 2400	✗
41		2496 to 2690	✓
42		3400 to 3600	✓
43		3600 to 3800	✓
48		3550 to 3700	✓
66	UL: 1710-1780	DL: 2110-2200	✓
71		617 to 698	✗
74/75/76		1427 to 1518	✗
77		3300 to 4200	✓
78		3300 to 3800	✓
79		4400 to 5000	✓

## 3. Antenna Characteristics

### 3.1 Test Setup – 30\*30cm Ground Plane

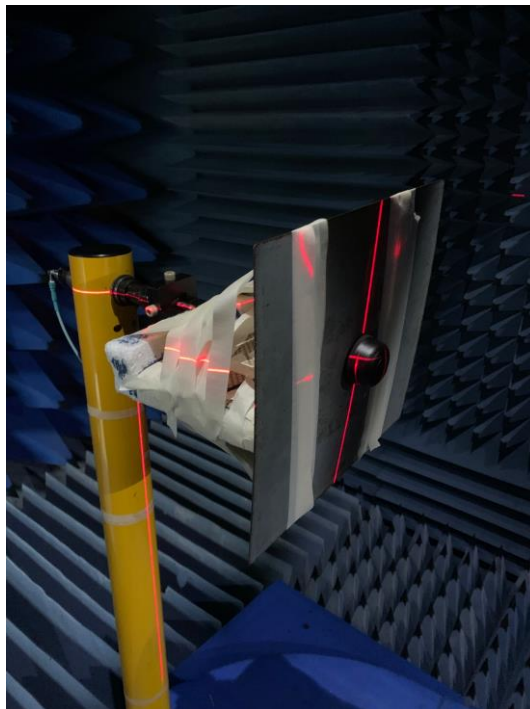

### 3.2 Return Loss – Cellular

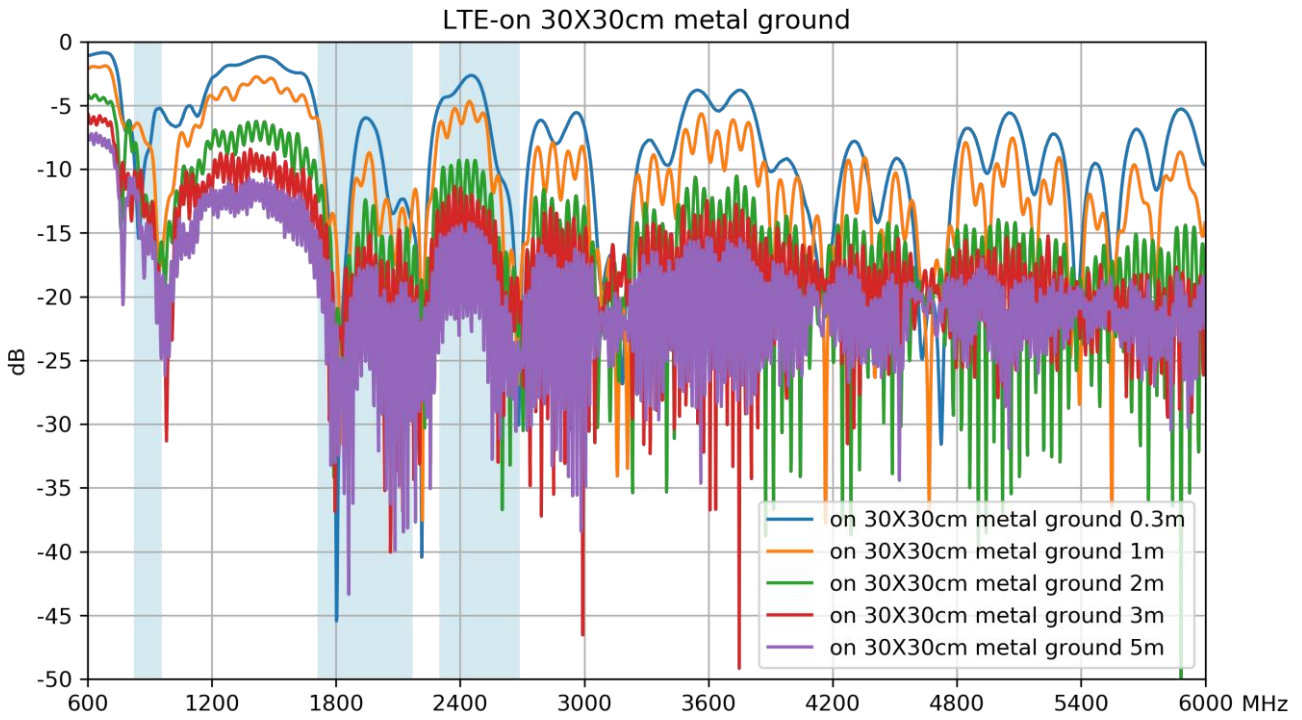
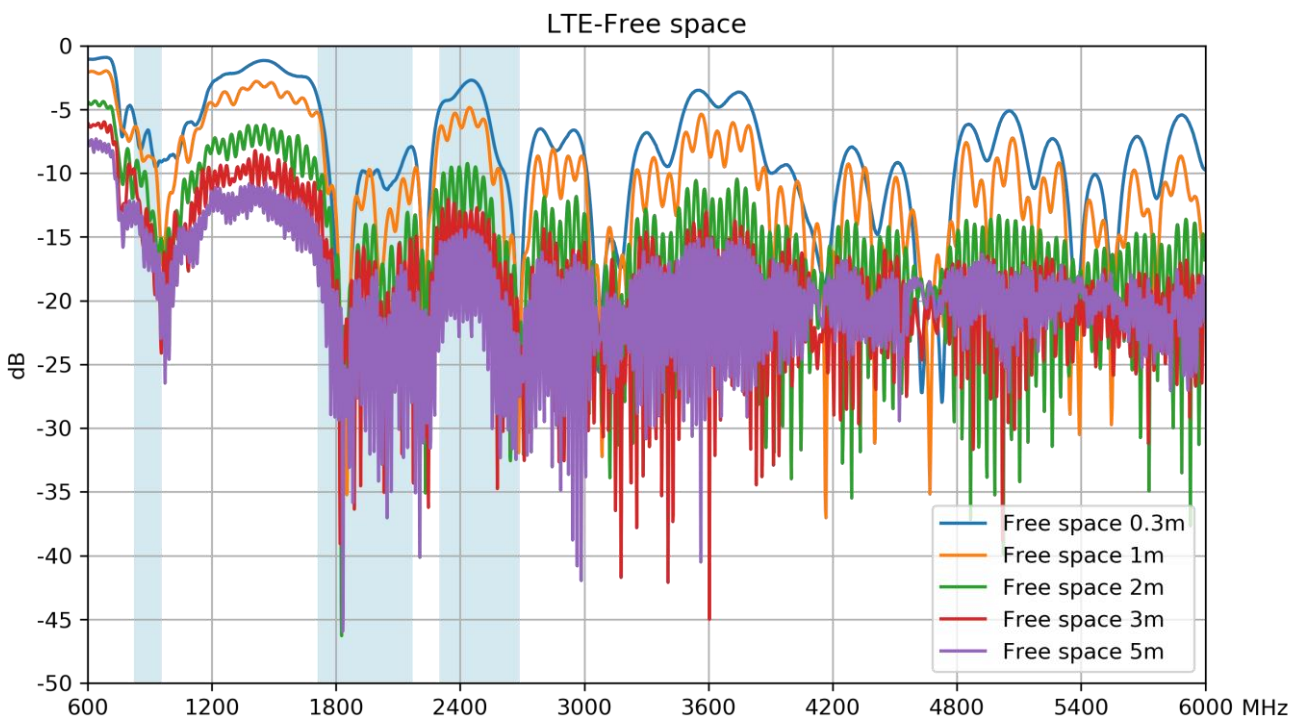

### 3.3 Efficiency – Cellular

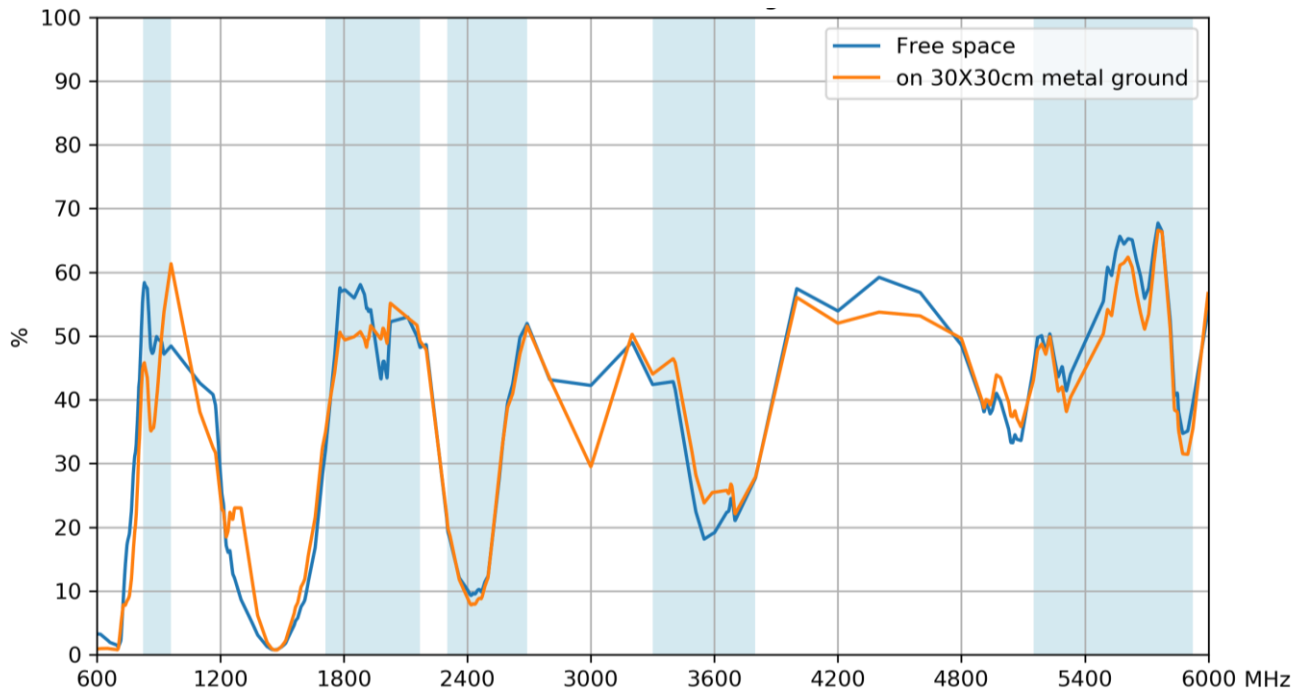

### 3.4 Average Gain – Cellular

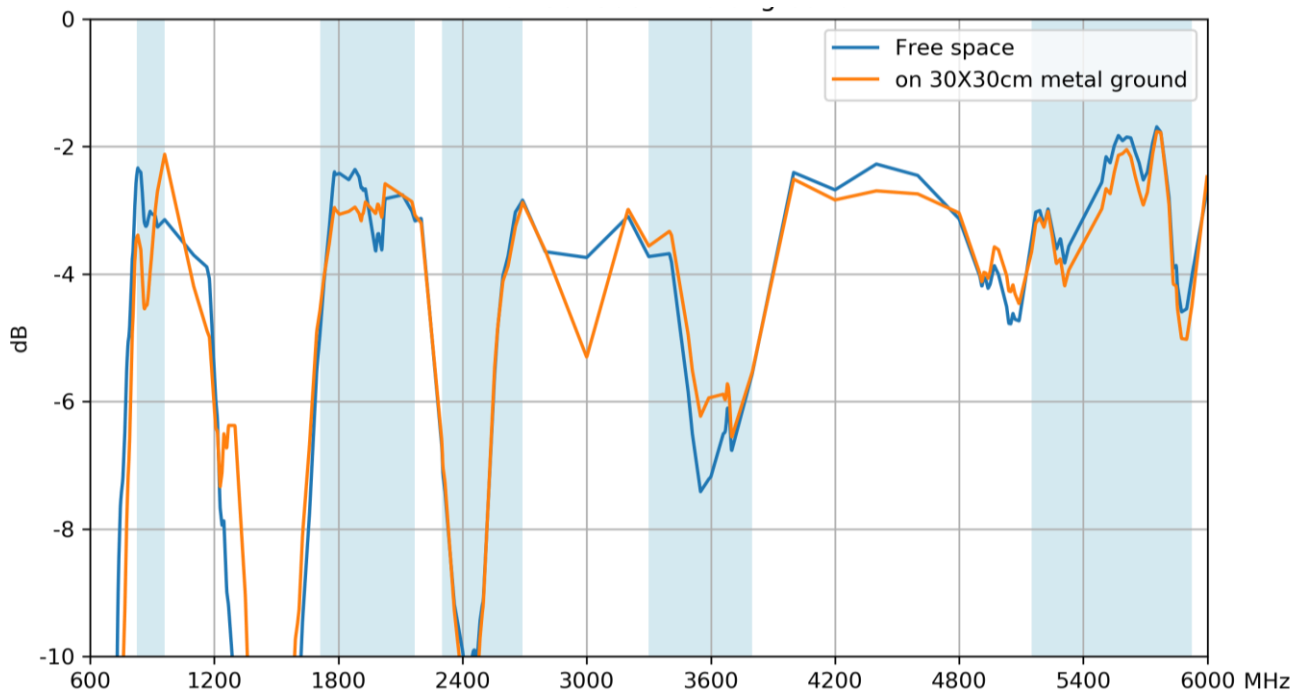



### 3.5 Peak Gain – Cellular

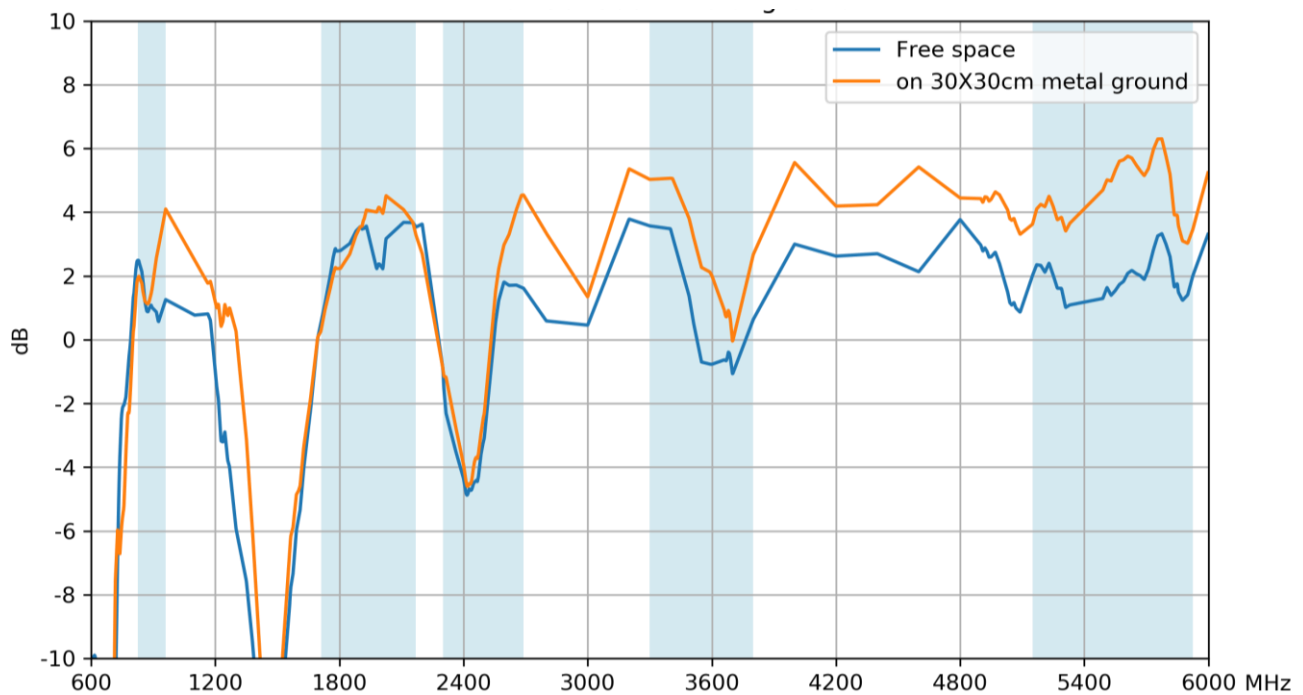

### 3.6 Return Loss – Wi-Fi

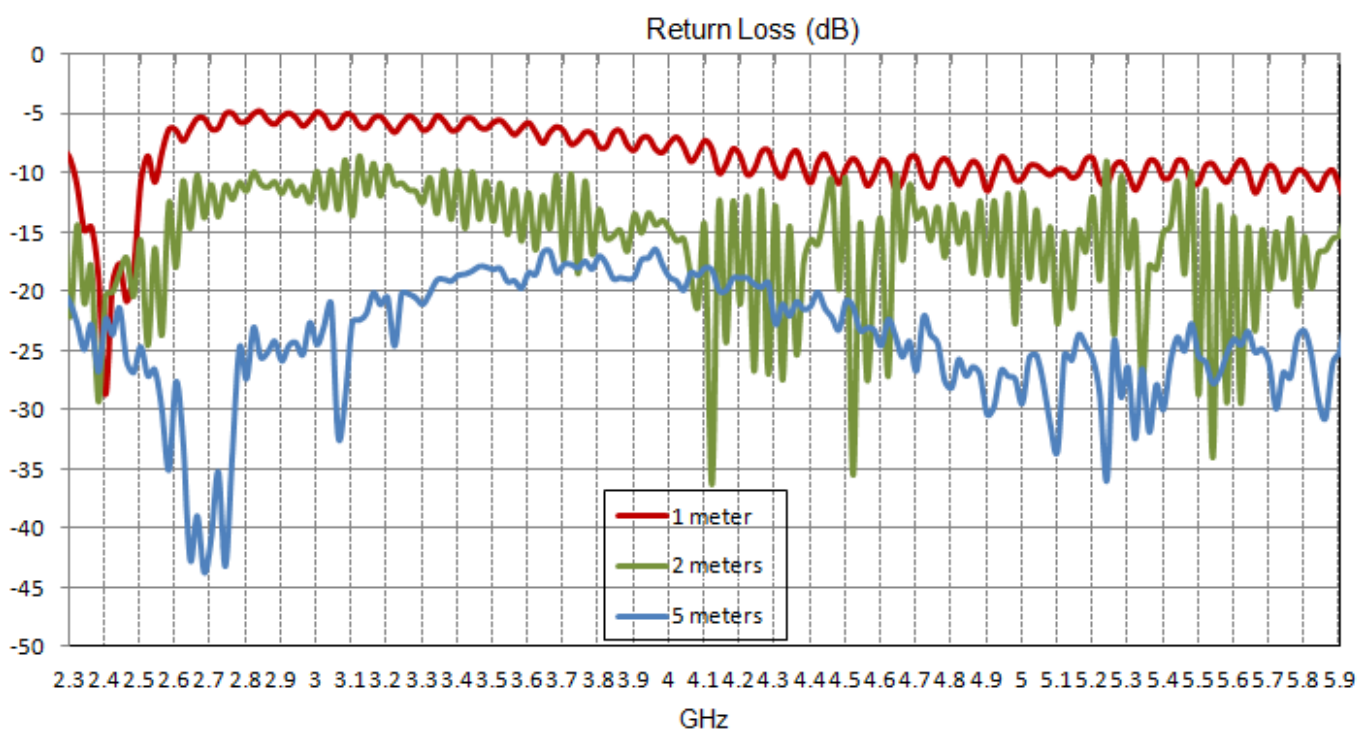

### 3.7 Efficiency – Wi-Fi

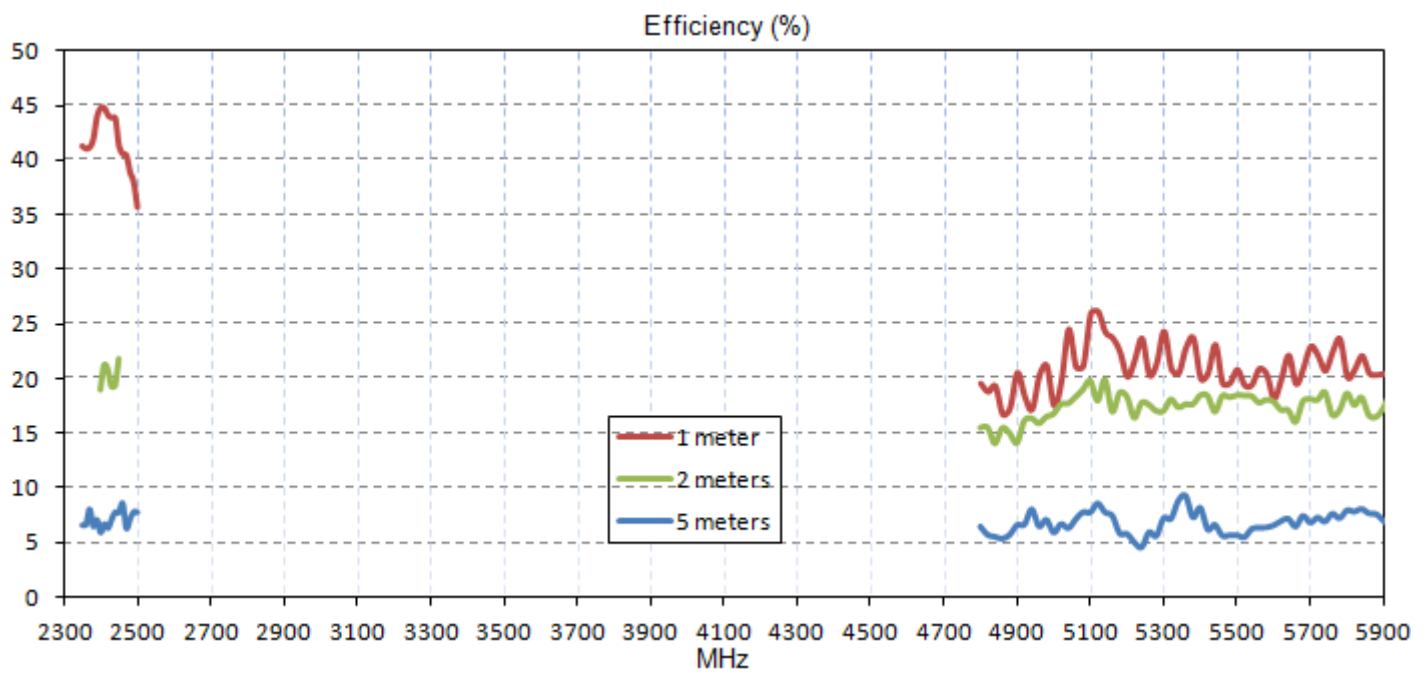

## 4. Radiation Patterns

### 4.1 890MHz 3D and 2D Radiation Patterns – Free Space

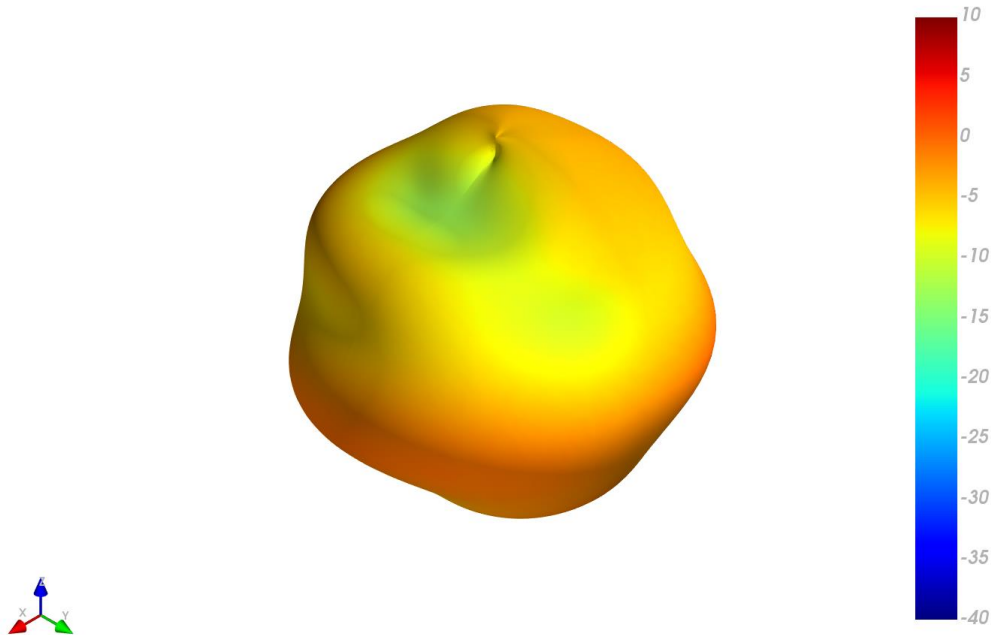

XY Plane

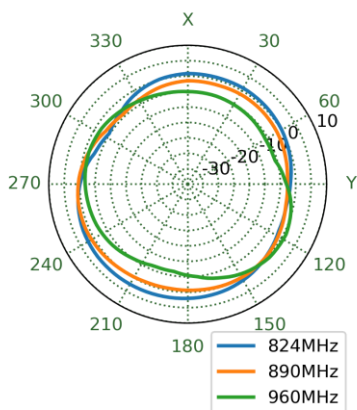

XZ Plane

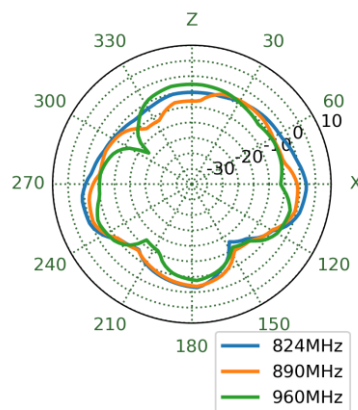

YZ Plane

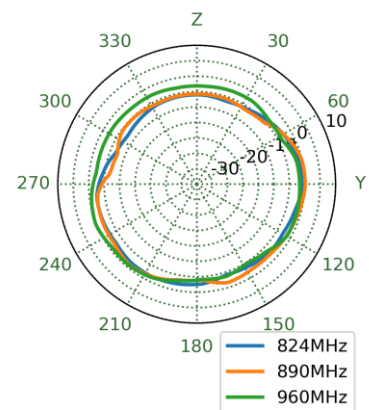

4.2 1805MHz 3D and 2D Radiation Patterns – Free Space

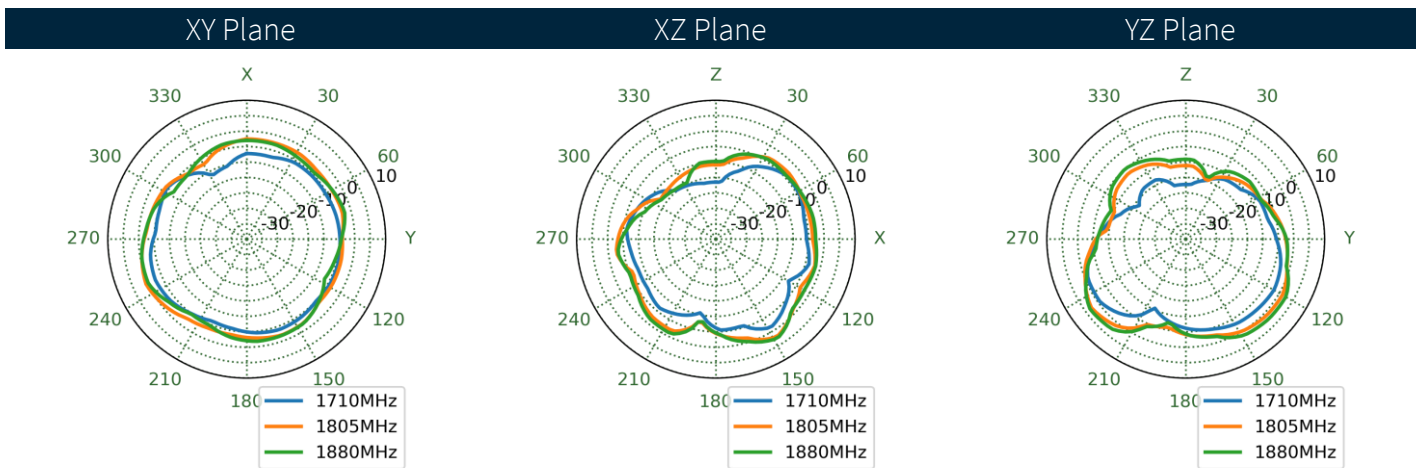
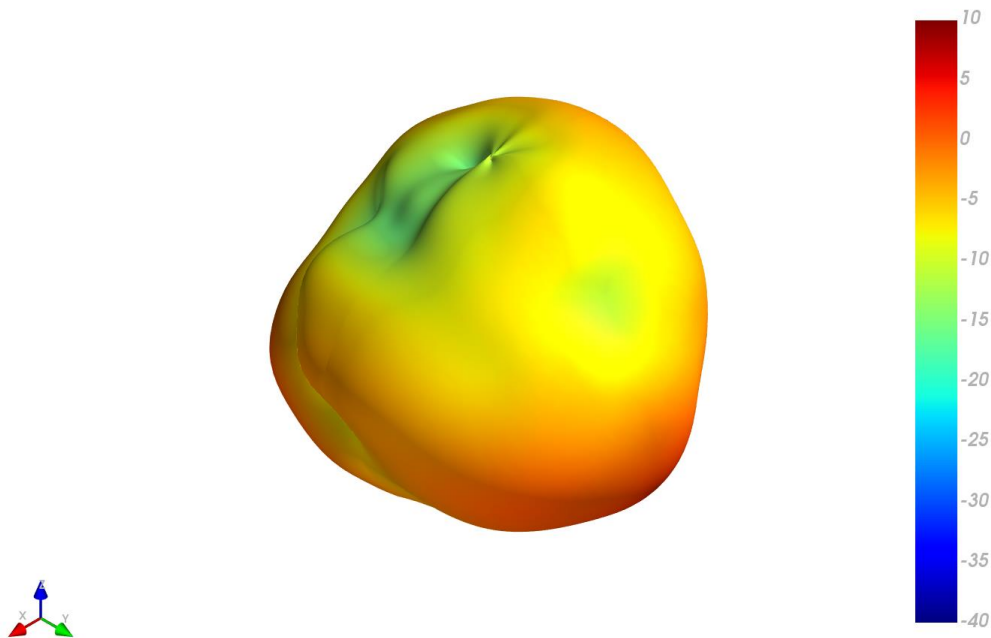

4.3 1920MHz 3D and 2D Radiation Patterns – Free Space

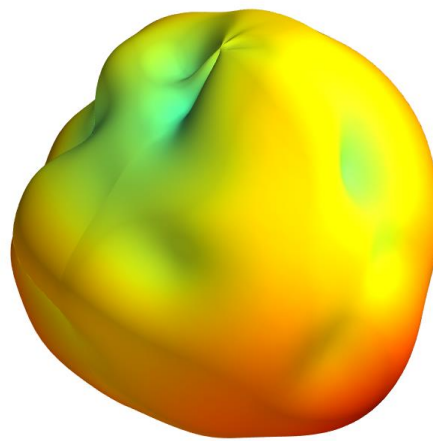

XY Plane

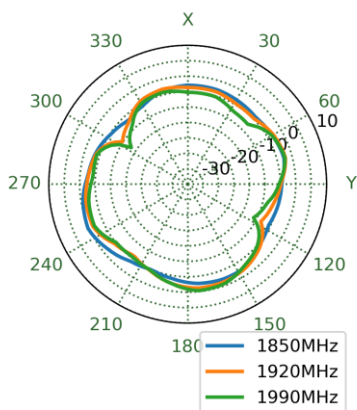

XZ Plane

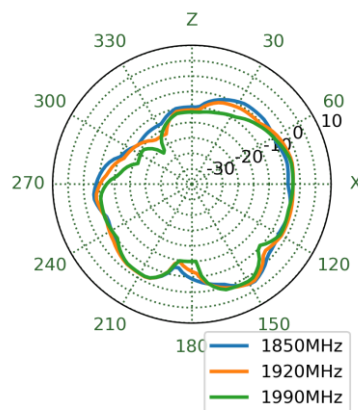

YZ Plane

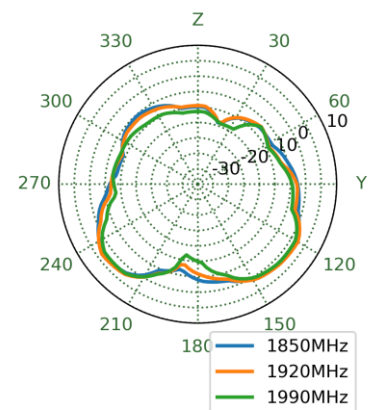

4.4 1990MHz 3D and 2D Radiation Patterns – Free Space

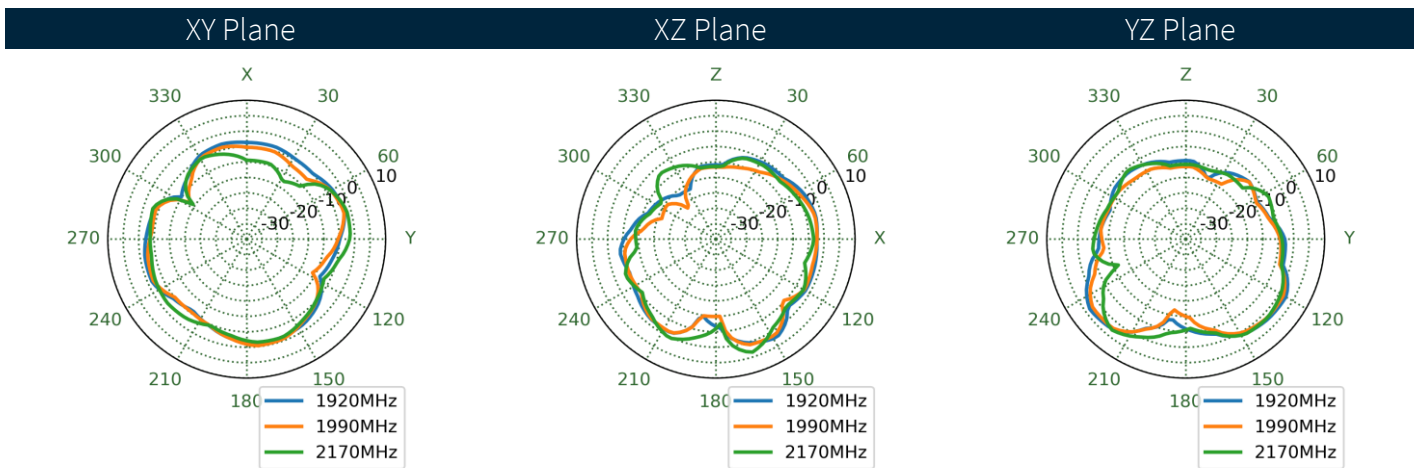
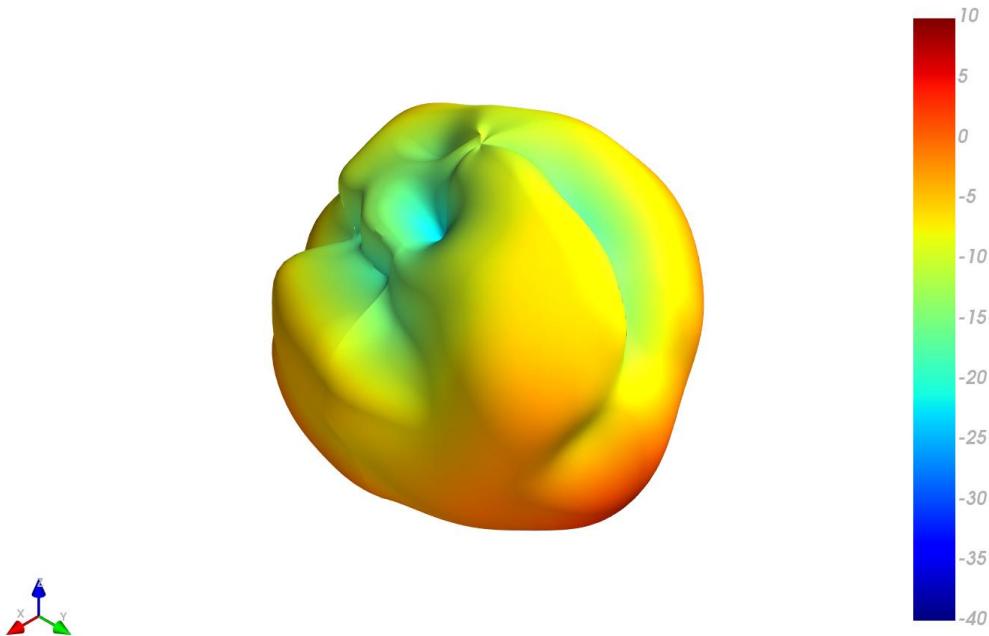

4.5 2595MHz 3D and 2D Radiation Patterns – Free Space

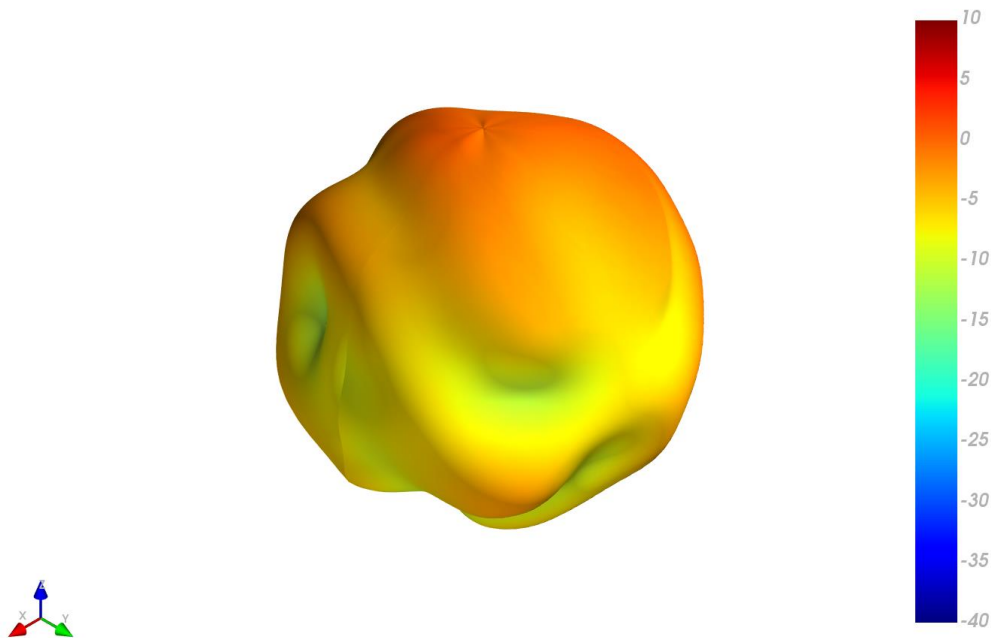

XY Plane XZ Plane YZ Plane

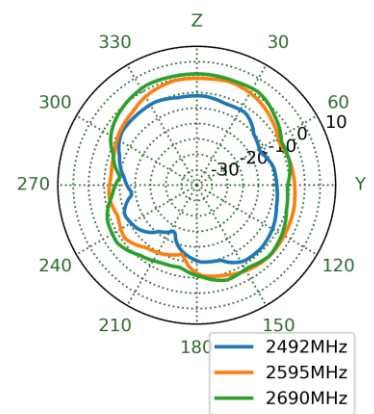
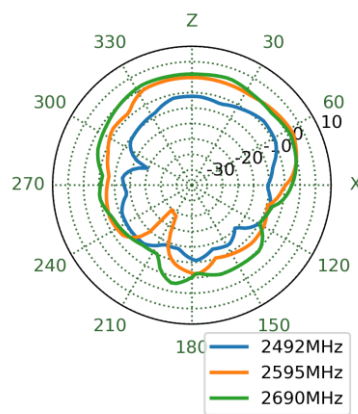
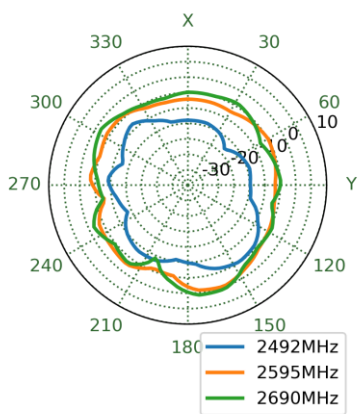

## 4.6 3550MHz 3D and 2D Radiation Patterns – Free Space

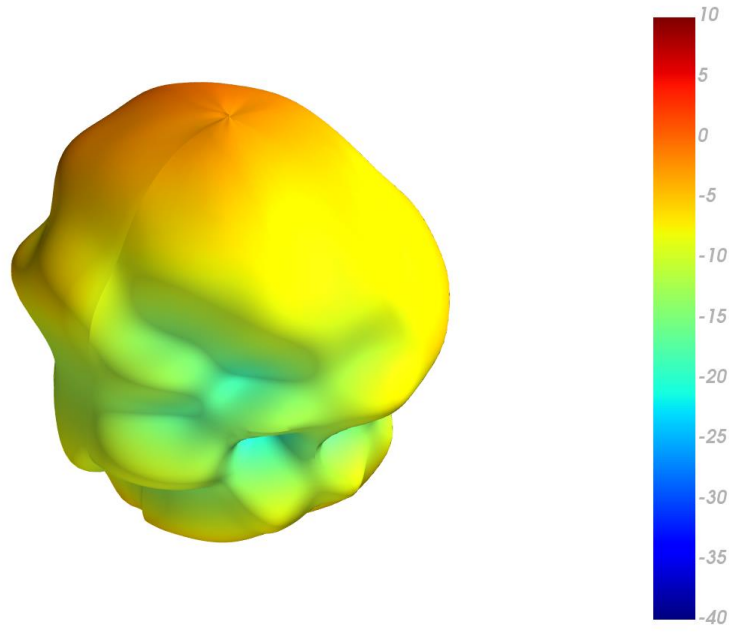

XY Plane

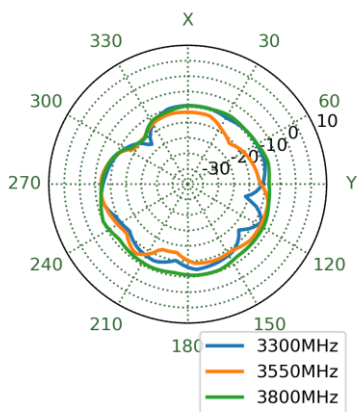

XZ Plane

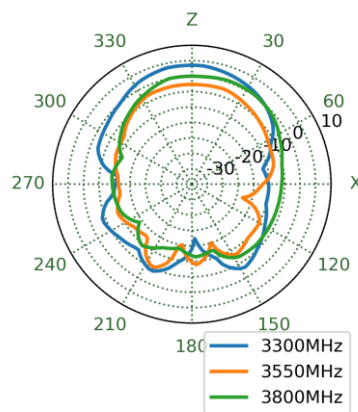

YZ Plane

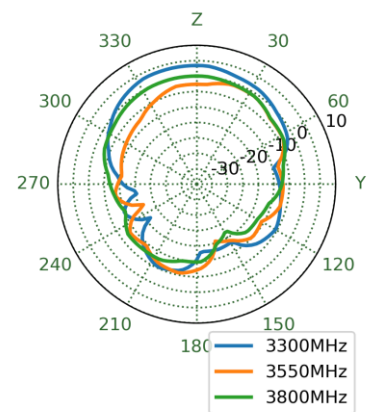



## 4.7 5530MHz 3D and 2D Radiation Patterns – Free Space

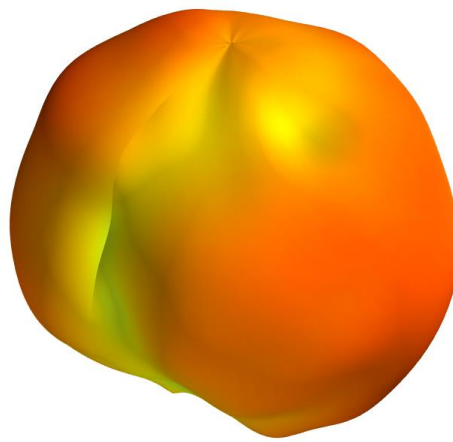

XY Plane

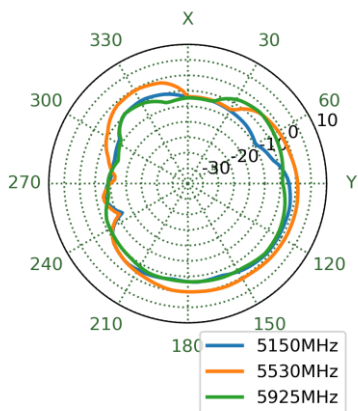

XZ Plane

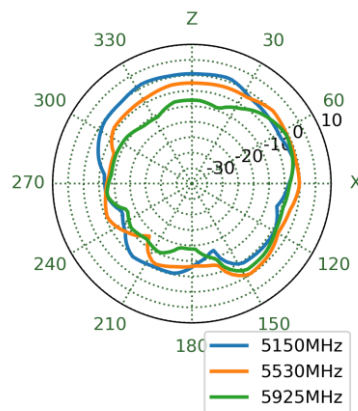

YZ Plane

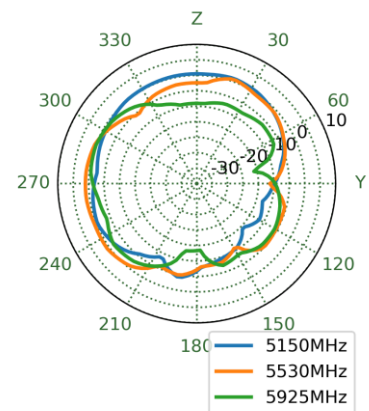

## 4.8 890MHz 3D and 2D Radiation Patterns – 30\*30cm Ground Plane

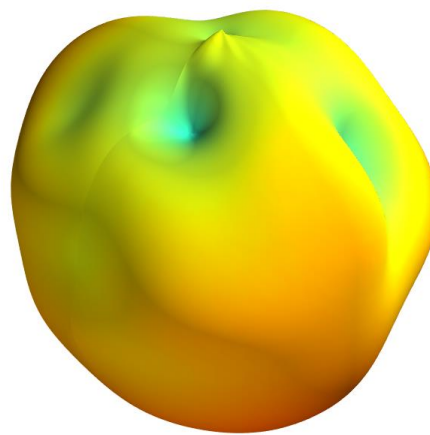

XY Plane

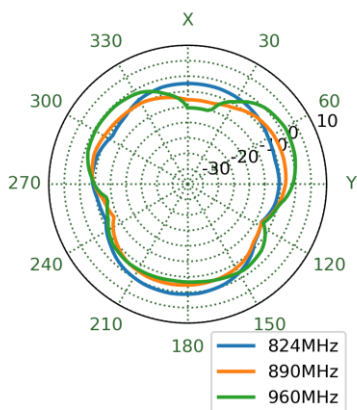

XZ Plane

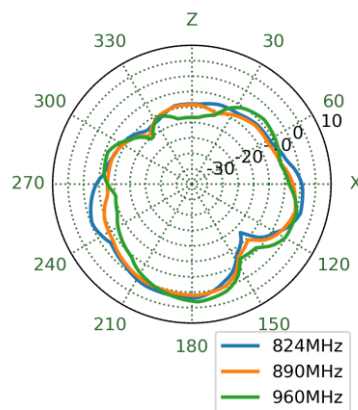

YZ Plane

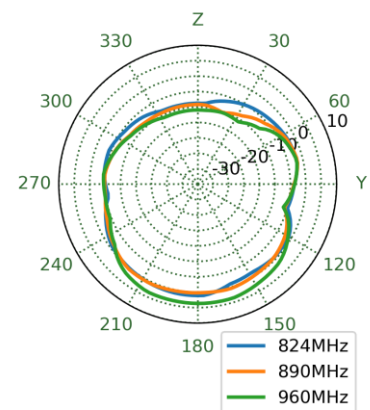

4.9 1805MHz 3D and 2D Radiation Patterns – 30\*30cm Ground Plane

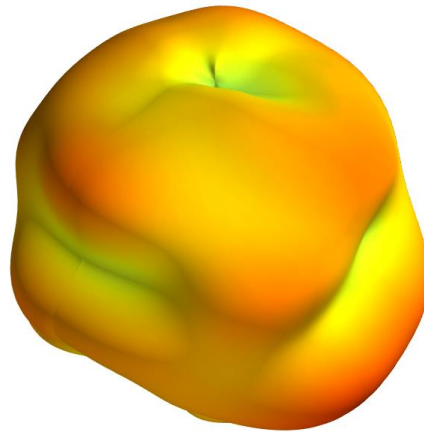

XY Plane XZ Plane YZ Plane

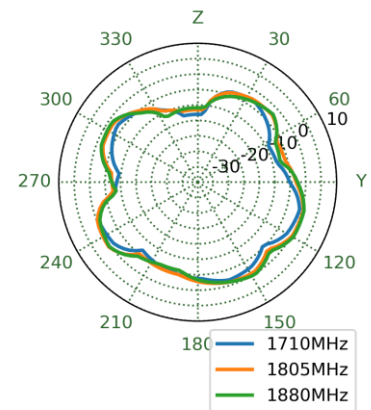
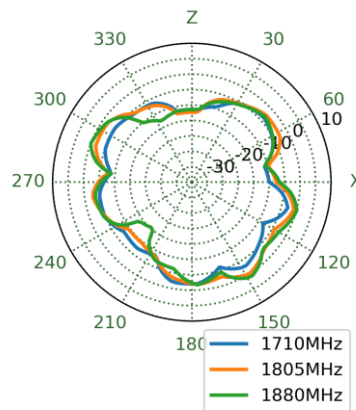
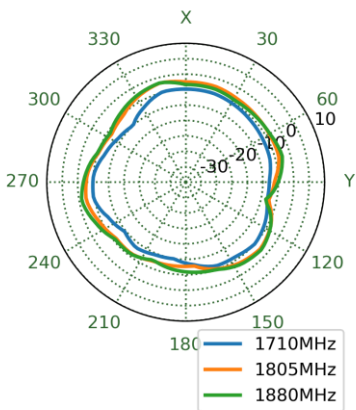

4.10 1920MHz 3D and 2D Radiation Patterns – 30\*30cm Ground Plane

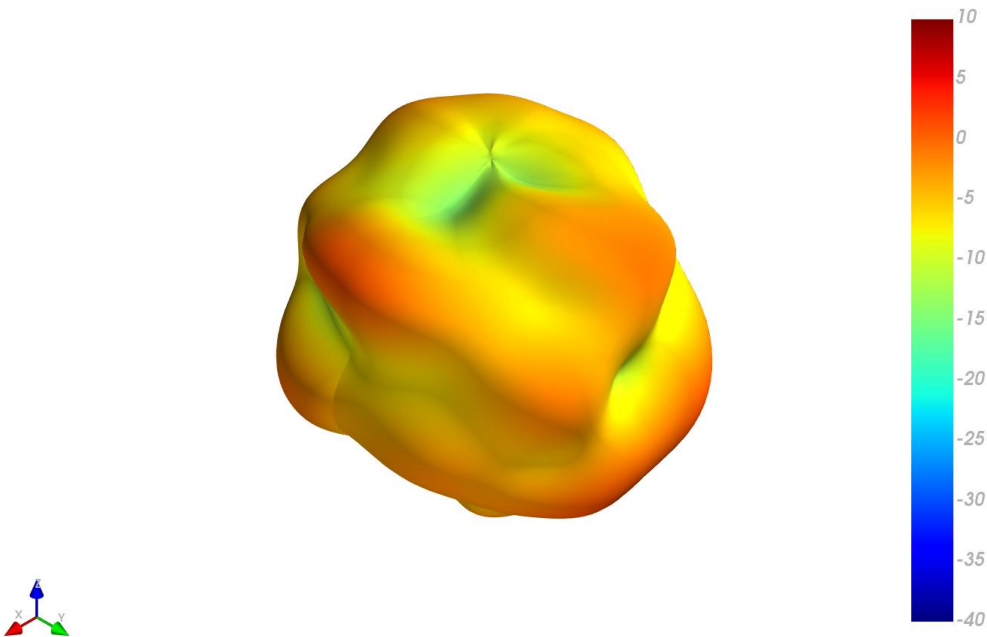

XY Plane XZ Plane YZ Plane

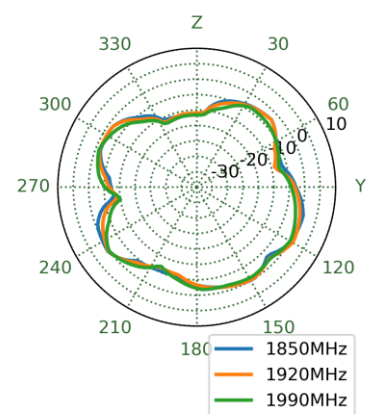
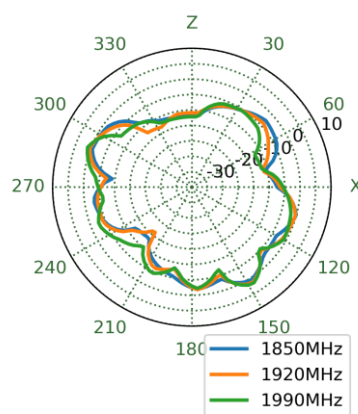
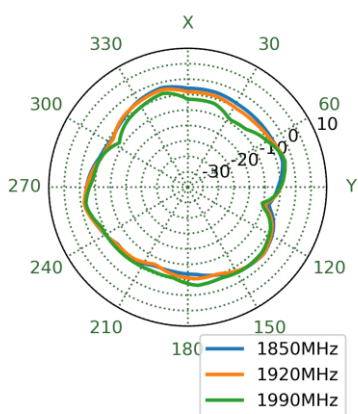

## 4.11 1990MHz 3D and 2D Radiation Patterns – 30\*30cm Ground Plane

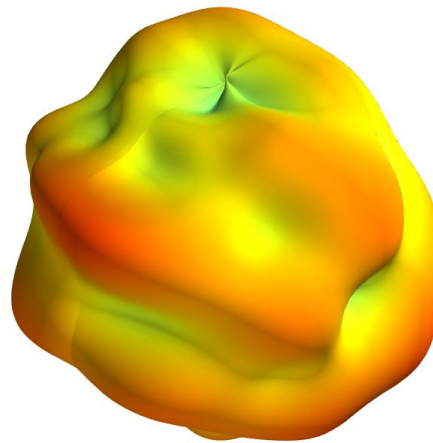

XY Plane

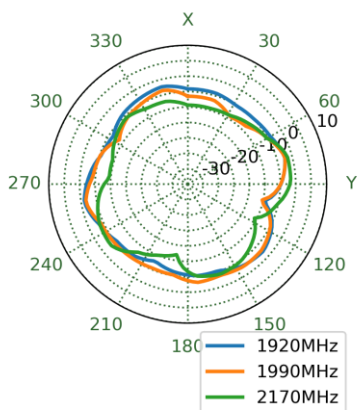

XZ Plane

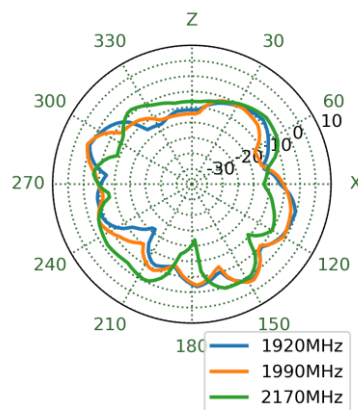

YZ Plane

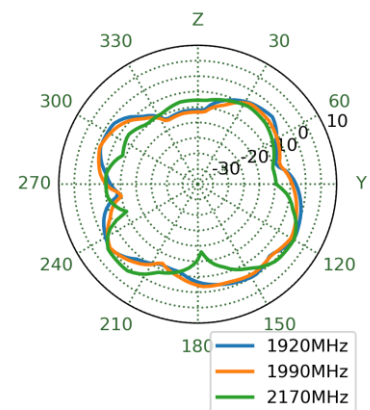

## 4.12 2595MHz 3D and 2D Radiation Patterns – 30\*30cm Ground Plane

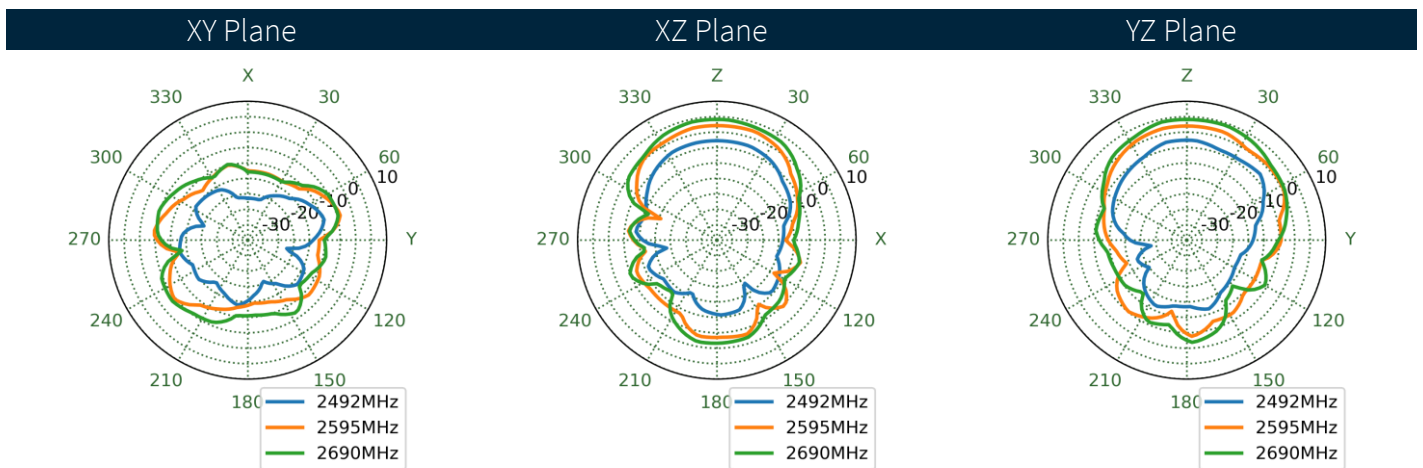
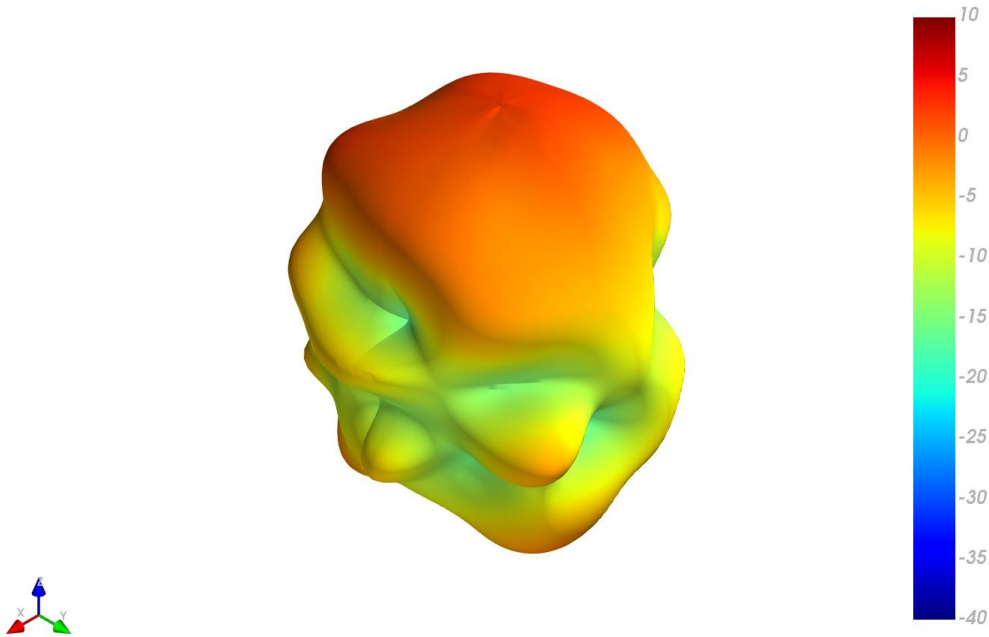

4.13 3550MHz 3D and 2D Radiation Patterns – 30\*30cm Ground Plane

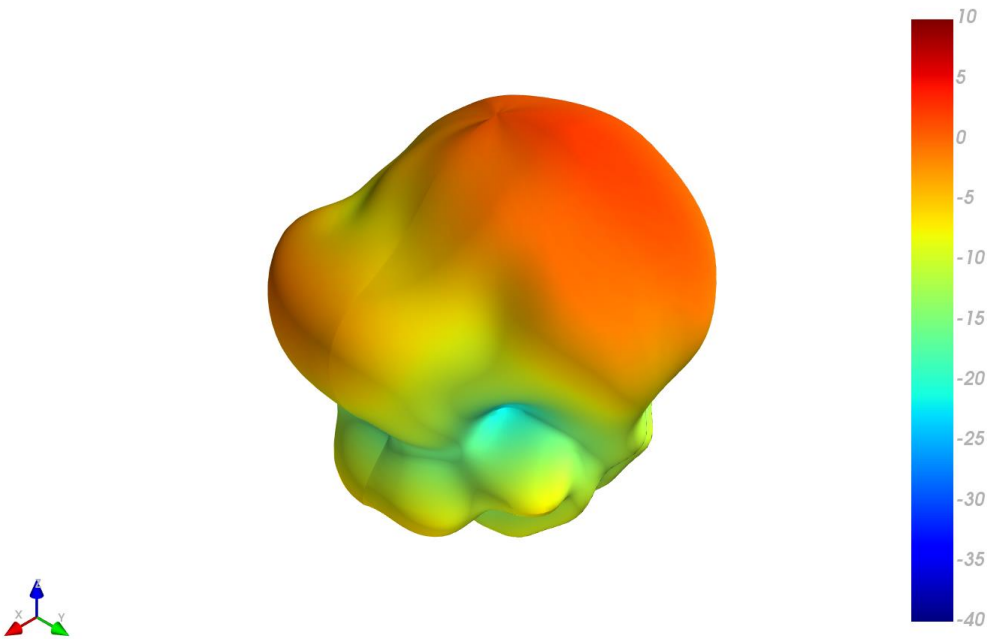

XY Plane

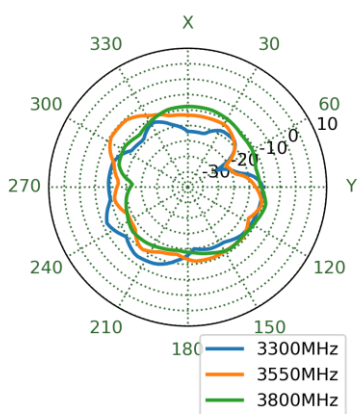

XZ Plane

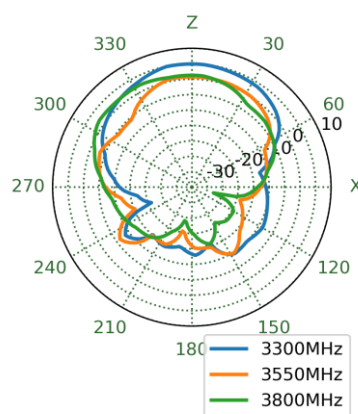

YZ Plane

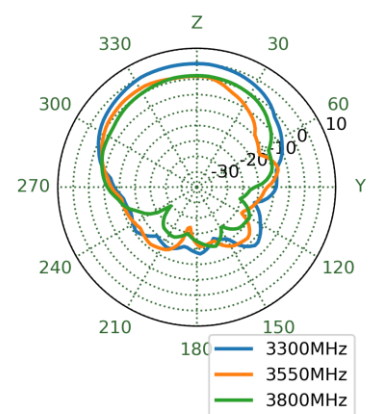

## 4.14 5530MHz 3D and 2D Radiation Patterns – 30\*30cm Ground Plane

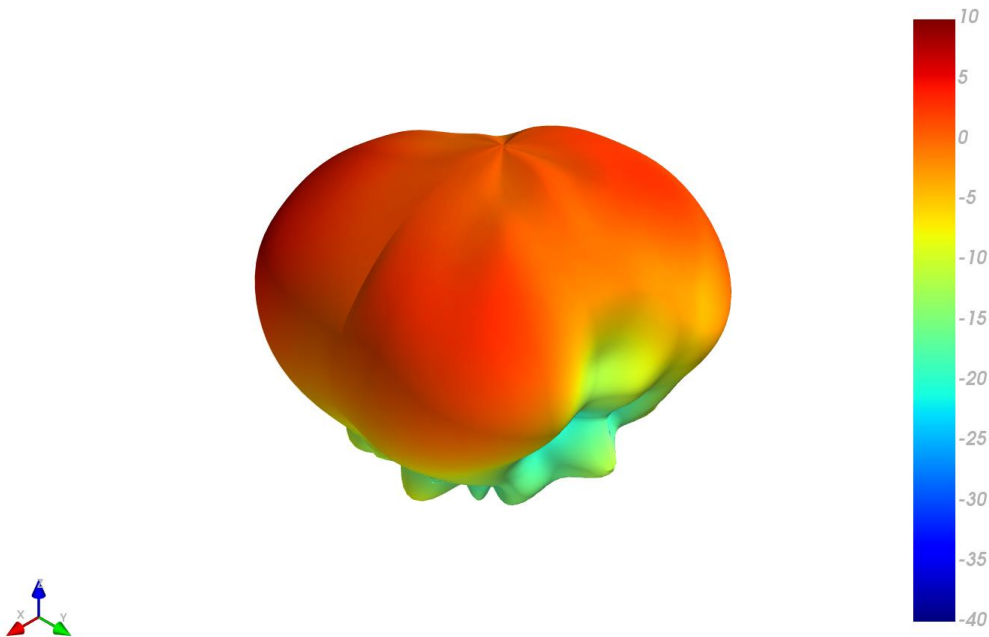

XY Plane

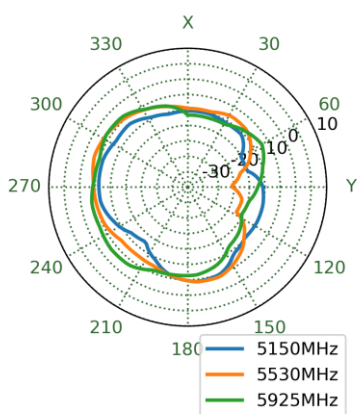

XZ Plane

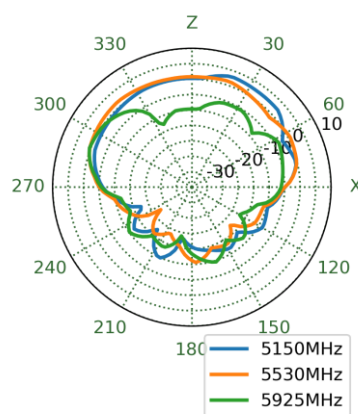

YZ Plane

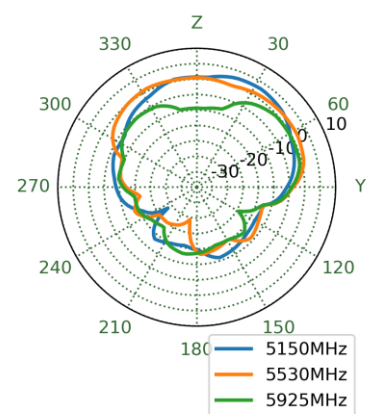



# 5. Mechanical Drawing (Units: mm)

6	5	4	3	2	1				
ISO NO: EDW-14-8-0053		<Release>		REV	ZONE	DESCRIPTION	ENG	APPROVED	ISSUED DATE
		△		ALL	Initial Design	Gabriel	Joanna	2014/02/20	
		△		ALL	Amend Label Color	Sandy	Joanna	2014/03/27	
		△		ALL	Amend heat shrink tube tolerance. Modify the PART NO, label material, tolerance, add dimension size. (ECR-17-8-170)	Rachel	Paul	2017/11/07	
		△		ALL	Change Label to Print Heat Shrink Tube.(ECR-18-8-009)	Bonnie	Joey	2019/01/18	

**Top View**

**Bottom Thread View**

**Front View** △

**Side View** △

**Detail A**  
Scale: 2:1

**Detail B**  
Scale: 2:1

Name	P/N	Material	Finish	QTY
1 Housing	000113F020008A	PC	Black	1
2 Double Sided Adhesive (Black Foam)	001012G010039A	3M 9448HK+CR4305	White Liner	1
3 Metal Base	000311F010069A	Zinc Alloy	Ni Plated	1
4 Rubber Stopper	000711F040064A	Silicone Rubber	Black	1
5 Outer Nut Cover	000111F020008A	ASA	Black	1
6 M18 Inner Nut Cut	000413F010061A	Steel Carbon	Zn Plated	1
7 Heat Shrink Tube (Cellular)	001316I010000A	PEPA	Blue Tube/White Text	1
8 Heat Shrink Tube (Wi-Fi)	001316C020000A	PEPA	Yellow Tube/Black Text	1

Name	P/N	Material	Finish	QTY
XX Cable Type	301515C000000A	RG316	Black	2
YY Connector Type	200212G000013A	SMA(M)ST	Au Plated	1
ZZ Connector Type	200213D000013A	RP-SMA(M)ST	Au Plated	1

Notes

1. New Part No.: MA.520.C.B208111.C208151

UNLESS OTHERWISE SPECIFIED TOLERANCES ON:  
 XX.± 0.5 .XX± 0.1  
 X.± 0.3 .XXX± 0.05

DATE: 2014/02/20 MAT'L:  
 UNIT: mm FINISH:  
 THIRD ANGLE PROJECTION SCALE: 1/1.25

APPROVED BY: Joanna CHECKED BY: Wayne DRAWN BY: Gabriel CUSTOMERS SIGNATURE / DATE

TITLE: MA.520 Hercules Cellular WiFi 2.4~5GHz Antenna  
 Cellular- 2M RG316 SMA(M) ST  
 2.4/5.8GHz- 2M RG316 RP-SMA(M) ST

PART NO. : MA520.A.BC.008 △

## 6. Packaging

1 pcs MA520.A.BC.008 per PE Bag  
 Dimensions: 300\*160mm  
 Weight: 170g

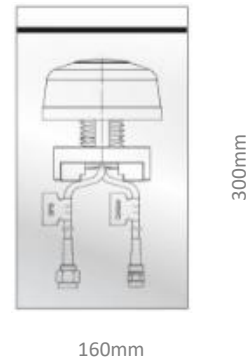

60 pcs MA520.A.BC.008 per carton  
 Dimensions: 390\*330\*260mm  
 Weight: 10.5Kg

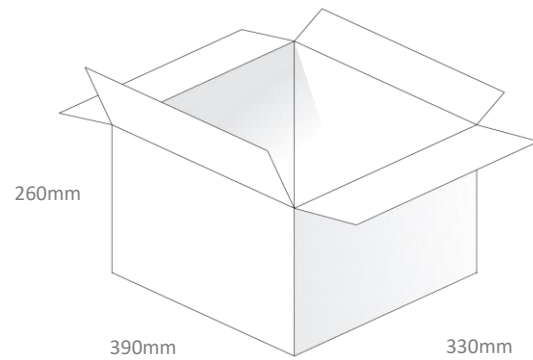

## 7. Installation Guidelines

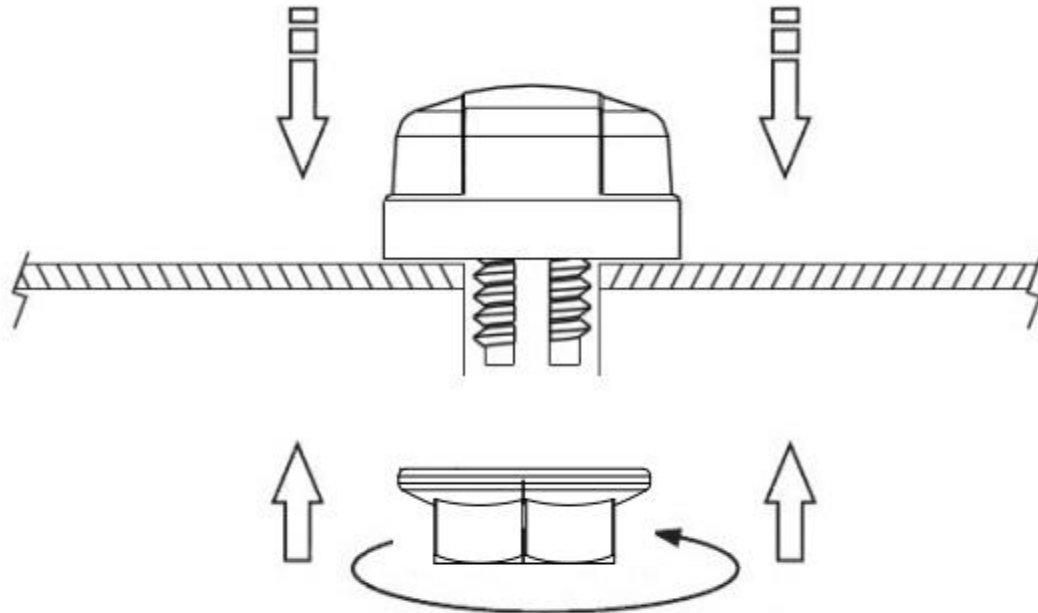

Recommended torque for Mounting is 24.5N·m  
 Maximum torque for mounting is 29.4 N·m

## 8. Application Note

### 8.1 Efficiency – Cellular

#### Free Space

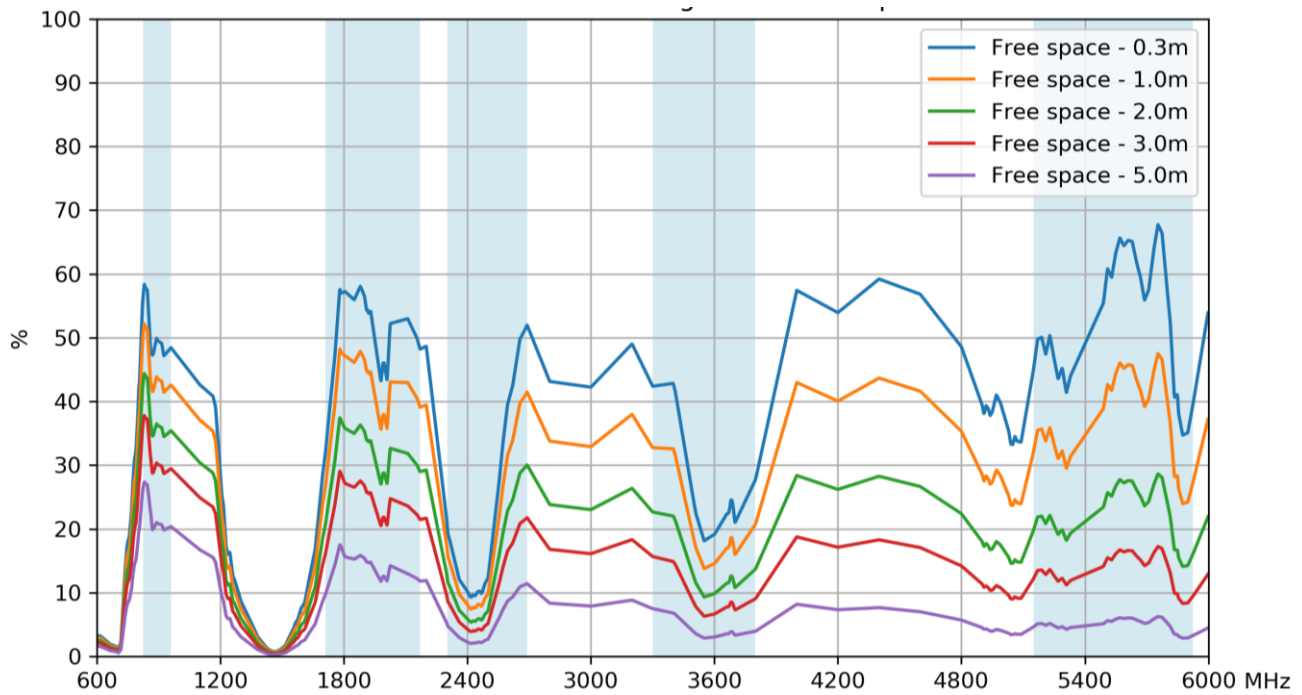

#### 30\*30cm Ground plane

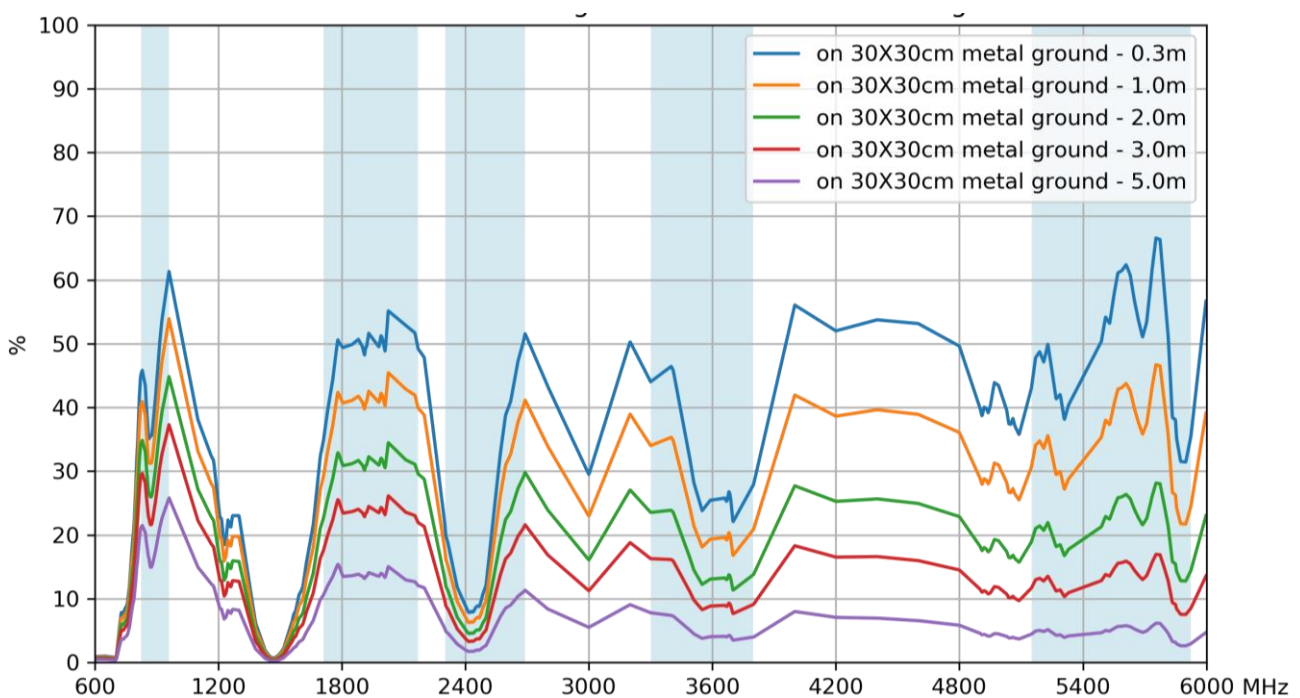

## 8.2 Average Gain – Cellular

### Free Space

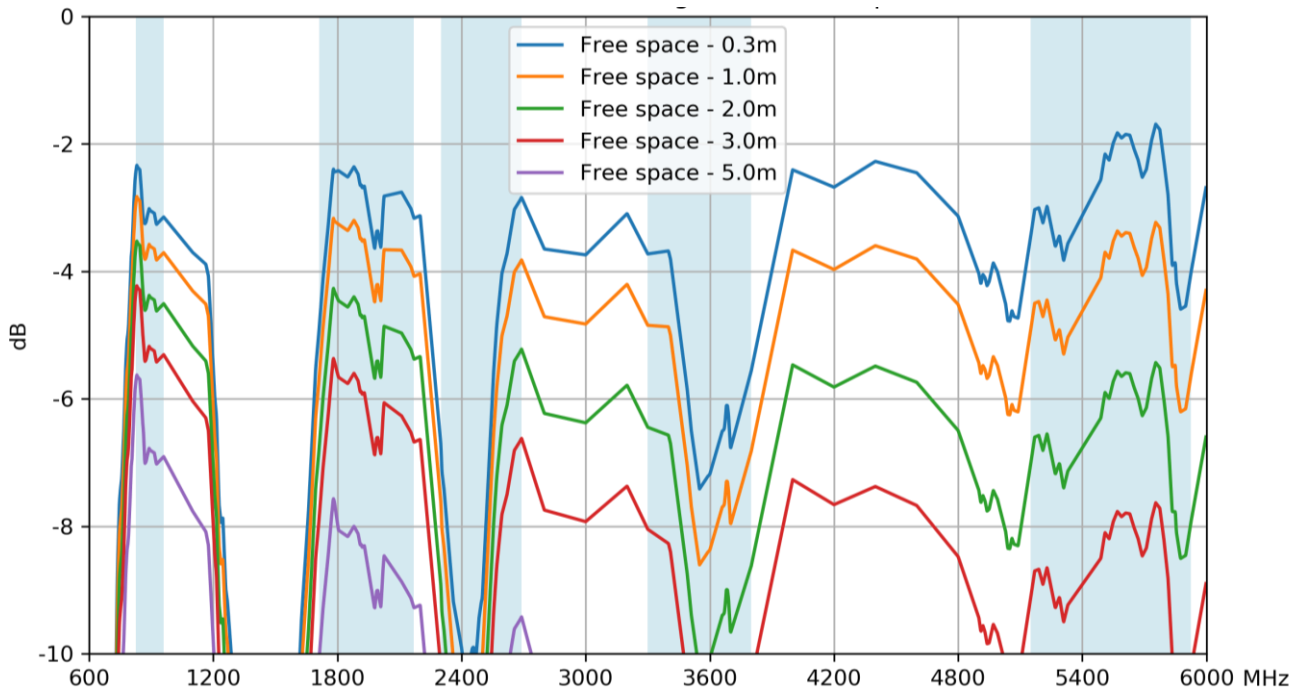

### 30\*30cm Ground plane

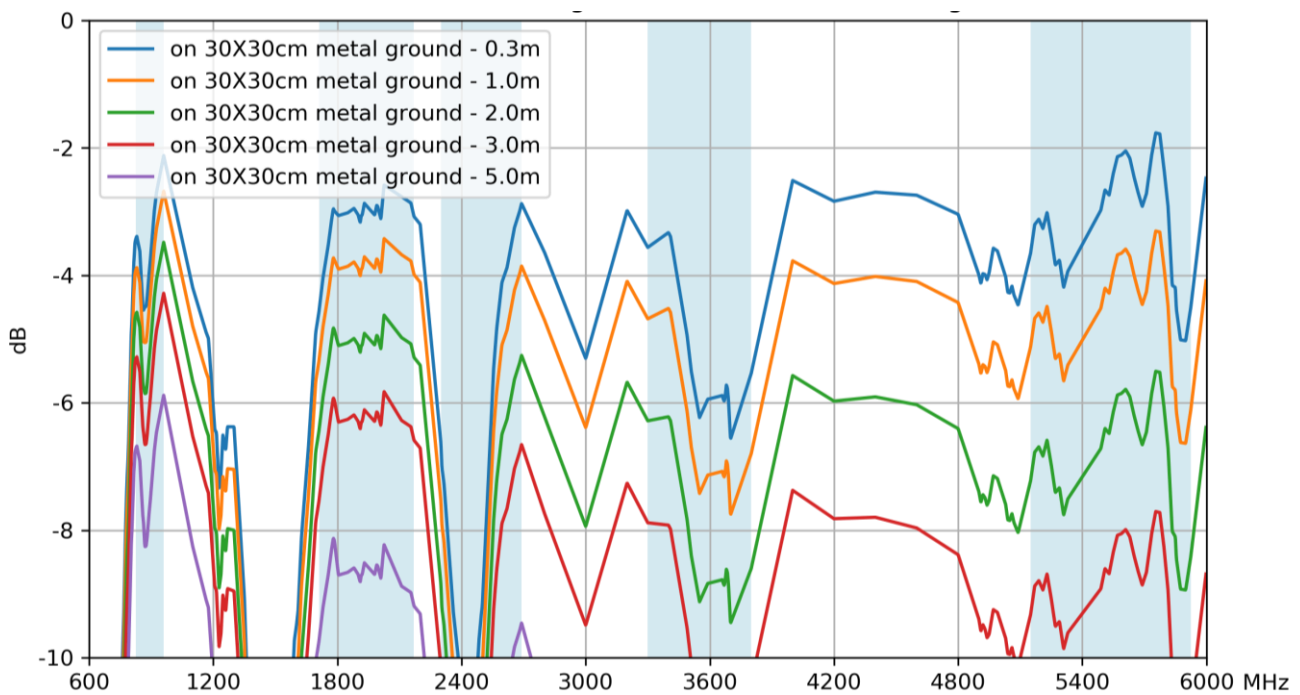

### 8.3 Peak Gain – Cellular

#### Free Space

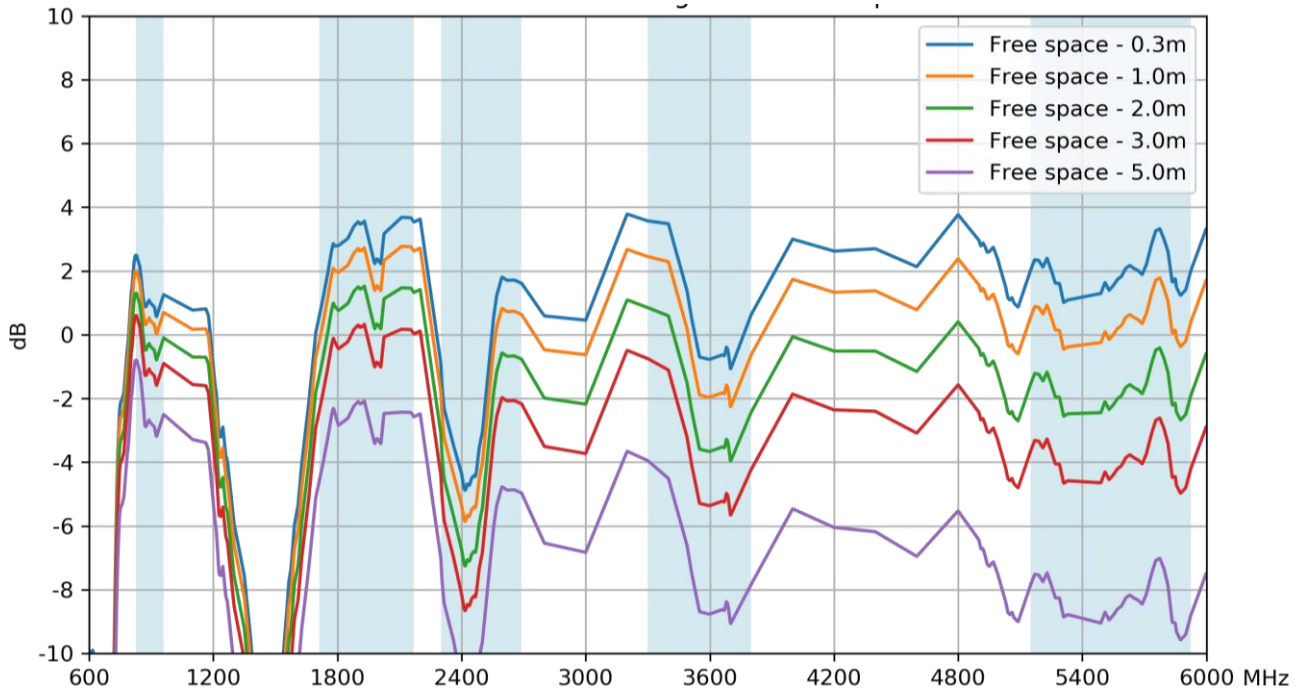

#### 30\*30cm Ground plane

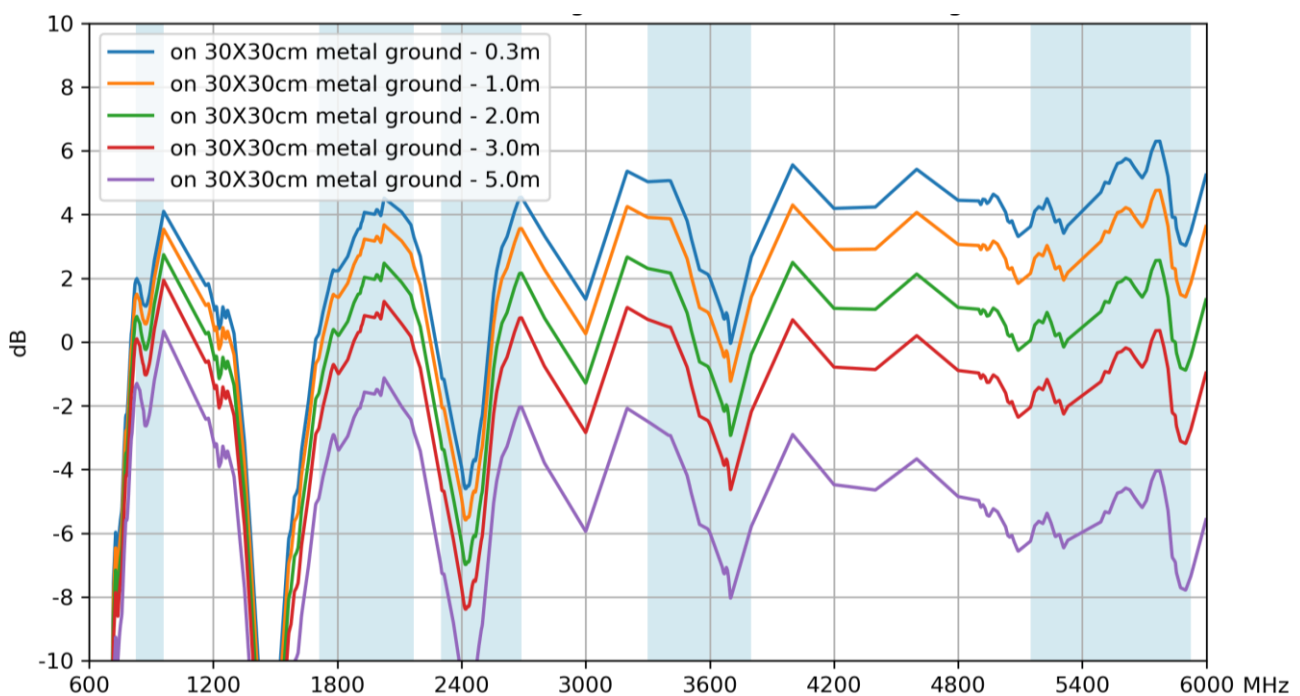

Changelog for the datasheet

**SPE-13-8-071 – MA520.A.BC.008**

**Revision: G (Current Version)**

Date:	2020-04-02
Notes:	Updated drawing, Packaging, data and images
Author:	Jack Conroy

**Previous Revisions**

**Revision: F**

Date:	2017-03-01
Notes:	Updated Introduction
Author:	Jack Conroy

**Revision: A (Original Release)**

Date:	2013-10-9
Notes:	Initial Datasheet Release
Author:	Technical Writer

**Revision: E**

Date:	2016-12-23
Notes:	Updated with revised salt spray data and disclaimer
Author:	Andy Mahoney

**Revision: D**

Date:	2016-05-18
Notes:	Updated drawing and pictures
Author:	Aine Doyle

**Revision: C**

Date:	2014-01-02
Notes:	Amended Photo
Author:	Aine Doyle

**Revision: B**

Date:	2013-10-24
Notes:	Amended Cellular data
Author:	Aine Doyle



**TAOGLAS**®

[www.taoglas.com](http://www.taoglas.com)

