

# Thin-Film RF/Microwave Directional Couplers

## CP0302/CP0402/CP0603/CP0805 and DB0603N/DB0805 3dB 90°

### CP0805 SMD Type



#### GENERAL DESCRIPTION

##### ITF (INTEGRATED THIN-FILM) TECHNOLOGY

The ITF SMD Coupler is based on thin-film multilayer technology. The technology provides a miniature part with excellent high frequency performance and rugged construction for reliable automatic assembly.

The ITF Coupler is offered in a variety of frequency bands compatible with various types of high frequency wireless systems.

#### FEATURES

- Small Size: 0805
- Frequency Range: 800MHz - 3GHz
- Characteristic Impedance: 50Ω
- Operating / Storage Temp.: -40°C to +85°C
- Power Rating: 3W Continuous
- Low Profile
- Rugged Construction
- Taped and Reeled

#### APPLICATIONS

- Mobile Communications
- Satellite TV Receivers
- GPS
- Vehicle Location Systems
- Wireless LAN's

#### DIMENSIONS:

millimeters (inches)

(Top View)

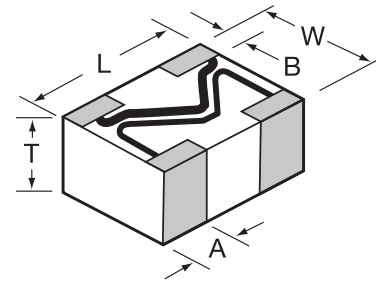

	0805
<b>L</b>	2.03±0.1 (0.080±0.004)
<b>W</b>	1.55±0.1 (0.061±0.004)
<b>T</b>	0.98±0.1 (0.039±0.004)
<b>A</b>	0.56±0.25 (0.022±0.010)
<b>B</b>	0.35±0.15 (0.014±0.006)

#### HOW TO ORDER

<b>CP</b>   <b>Style</b> Directional Coupler	<b>0805</b>   <b>Size</b> 0805	<b>A</b>   <b>Layout Type</b> (see layout types)	<b>0902</b>   <b>Frequency</b> MHz	<b>A</b>   <b>Sub-Type</b> (see layout sub-types)	<b>S</b>   <b>Termination Code</b> W = Nickel/Solder (Sn/Pb) **S = Nickel / Lead Free Solder (Sn100)	<b>TR</b>   <b>Packaging Code</b> TR = Tape and Reel
---	---	---	---	--	--	---

**Not RoHS Compliant**



LEAD-FREE

LEAD-FREE COMPATIBLE COMPONENT



RoHS COMPLIANT

For RoHS compliant products, please select correct termination style.

**\*\*RoHS compliant**

#### QUALITY INSPECTION

Finished parts are 100% tested for electrical parameters and visual characteristics. Each production lot is evaluated on a sample basis for:

- Static Humidity: 85°C, 85% RH, 160 hours
- Endurance: 125°C, I<sub>R</sub>, 4 hours

#### TERMINATION

Nickel/Solder coating (Sn, Pb) compatible with automatic soldering technologies: reflow, wave soldering, vapor phase and manual.

#### Recommended Pad Layout Dimensions mm (inches)

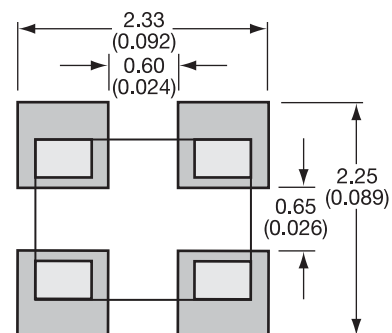

NOTE: Components must be mounted on the board with the white (Alumina) side DOWN.

# Thin-Film RF/Microwave Directional Couplers

## CP0302/CP0402/CP0603/CP0805 and DB0603N/DB0805 3dB 90°

### CP0805 Layout Types

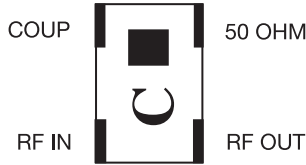

Type: A  
Sub-Type: A

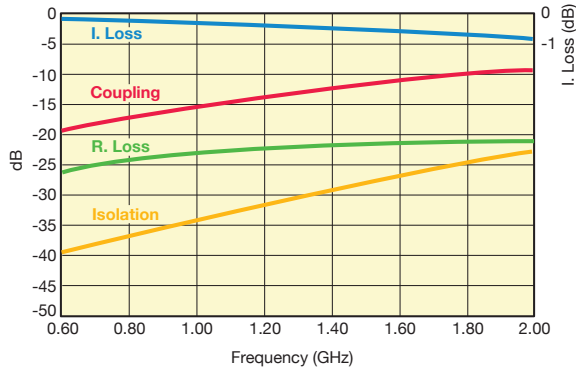

P/N Examples	Frequency Band [MHz]	Coupling [dB]	I. Loss max	VSWR max
CP0805A0836AS	824 - 849	16.5±1	0.25	1.2
CP0805A0881AS	869 - 894	16±1	0.25	1.2
CP0805A0902AS	890 - 915	16±1	0.25	1.2
CP0805A0947AS	935 - 960	15.5±1	0.25	1.2
CP0805A0897AS	880 - 915	16±1	0.25	1.2
CP0805A0942AS	925 - 960	15.5±1	0.25	1.2
CP0805A1441AS	1429 - 1453	12±1	0.5	1.3
CP0805A1747AS	1710 - 1785	10.5±1	0.7	1.4
CP0805A1842AS	1805 - 1880	10±1	0.8	1.4
CP0805A1880AS	1850 - 1910	9.5±1	0.8	1.4
CP0805A1960AS	1930 - 1990	9.5±1	0.8	1.4
CP0805A1907AS	1895 - 1920	9.5±1	0.8	1.4
CP0805A1890AS	1880 - 1900	9.5±1	0.8	1.4



Type: A  
Sub-Type: B

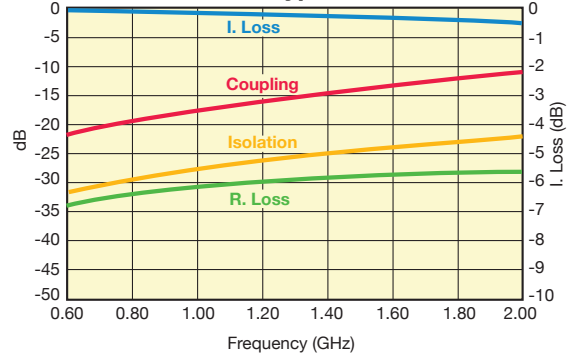

P/N Examples	Frequency Band [MHz]	Coupling [dB]	I. Loss max	VSWR max
CP0805A0836BS	824 - 849	19±1	0.25	1.2
CP0805A0881BS	869 - 894	18.5±1	0.25	1.2
CP0805A0902BS	890 - 915	18±1	0.25	1.2
CP0805A0947BS	935 - 960	18±1	0.25	1.2
CP0805A0897BS	880 - 915	18.5±1	0.25	1.2
CP0805A0942BS	925 - 960	18±1	0.25	1.2
CP0805A1441BS	1429 - 1453	14.5±1	0.35	1.2
CP0805A1747BS	1710 - 1785	12.5±1	0.5	1.4
CP0805A1842BS	1805 - 1880	12.5±1	0.5	1.4
CP0805A1880BS	1850 - 1910	12±1	0.6	1.4
CP0805A1960BS	1930 - 1990	11.5±1	0.7	1.4
CP0805A1907BS	1895 - 1920	12±1	0.6	1.4
CP0805A1890BS	1880 - 1900	12±1	0.6	1.4
CP0805A2442BS	2400 - 2484	10±1	0.9	1.4

Type: A  
Sub-Type: C

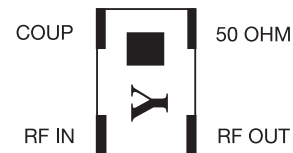
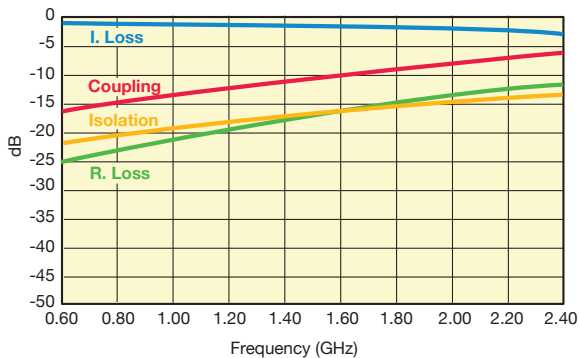

P/N Examples	Frequency Band [MHz]	Coupling [dB]	I. Loss max	VSWR max
CP0805A0836CS	824 - 849	14±1	0.5	1.4
CP0805A0881CS	869 - 894	13.5±1	0.5	1.4
CP0805A0902CS	890 - 915	13.5±1	0.5	1.4
CP0805A0947CS	935 - 960	13±1	0.5	1.4
CP0805A0897CS	880 - 915	13.5±1	0.5	1.4
CP0805A0942CS	925 - 960	13±1	0.5	1.4
CP0805A1441CS	1429 - 1453	9.5±1	1.15	1.8
CP0805A1747CS	1710 - 1785	8±1	1.6	2.2
CP0805A1842CS	1805 - 1880	8±1	1.6	2.2
CP0805A1880CS	1850 - 1910	7.5±1	1.75	2.2
CP0805A1960CS	1930 - 1990	7.5±1	1.75	2.2
CP0805A1907CS	1895 - 1920	7.5±1	1.75	2.2
CP0805A1890CS	1880 - 1900	7.5±1	1.75	2.2
CP0805A2442CS	2400 - 2484	6±1	2.5	2.2

Important: Couplers can be used at any frequency within the indicated range.



The Important Information/Disclaimer is incorporated in the catalog where these specifications came from or available online at [www.avx.com/disclaimer/](http://www.avx.com/disclaimer/) by reference and should be reviewed in full before placing any order.

# Thin-Film RF/Microwave Directional Couplers

## CP0302/CP0402/CP0603/CP0805 and DB0603N/DB0805 3dB 90°

### CP0805 Layout Types

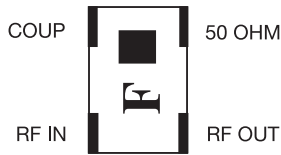

**Type: A**  
**Sub-Type: D**

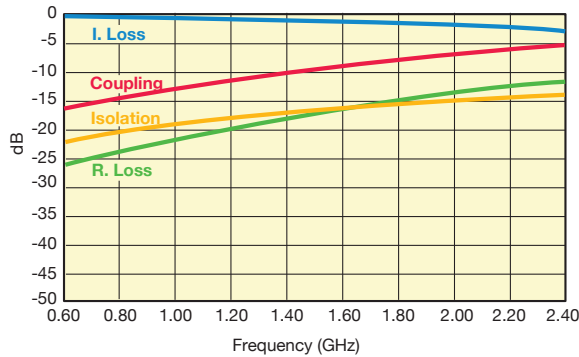

P/N Examples	Frequency Band [MHz]	Coupling [dB]	I. Loss max	VSWR max
CP0805A0836DS	824 - 849	13.0±1	0.5	1.4
CP0805A0881DS	869 - 894	12.5±1	0.5	1.4
CP0805A0902DS	890 - 915	12.5±1	0.5	1.4
CP0805A0947DS	935 - 960	12±1	0.5	1.4
CP0805A0897DS	880 - 915	12.5±1	0.5	1.4
CP0805A0942DS	925 - 960	12±1	0.5	1.4
CP0805A1441DS	1429 - 1453	8.5±1	1.25	1.8
CP0805A1747DS	1710 - 1785	7±1	1.85	1.8
CP0805A1842DS	1805 - 1880	7±1	1.85	1.8
CP0805A1880DS	1850 - 1910	7±1	1.85	1.8
Cp0805A1960DS	1930 - 1990	6.5±1	2.15	2.1
CP0805A1907DS	1895 - 1920	6.5±1	2.15	2.1
CP0805A1890DS	1880 - 1900	7±1	1.85	1.8
CP0805A2442DS	2400 - 2484	5.5±1	2.4	2.1

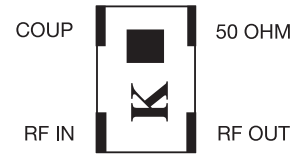

**Type: A**  
**Sub-Type: E**

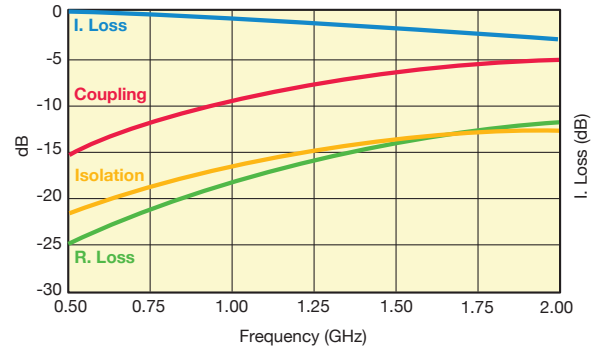

P/N Examples	Frequency Band [MHz]	Coupling [dB]	I. Loss max	VSWR max
CP0805A0836ES	824 - 849	11±1	0.85	1.4
CP0805A0881ES	869 - 894	10.5±1	0.85	1.4
CP0805A0902ES	890 - 915	10.5±1	0.85	1.4
CP0805A0947ES	935 - 960	10±1	0.85	1.4
CP0805A0897ES	880 - 915	10.5±1	0.85	1.4
CP0805A0942ES	925 - 960	10±1	0.85	1.4
CP0805A1441ES	1429 - 1453	7±1	1.8	1.8
CP0805A1747ES	1710 - 1785	5.5±1	2.7	2.2
CP0805A1842ES	1805 - 1880	5.5±1	2.7	2.2
CP0805A1880ES	1850 - 1910	5±1	3.15	2.4
Cp0805A1960ES	1930 - 1990	5±1	3.15	2.4
CP0805A1907ES	1895 - 1920	5±1	3.15	2.4
CP0805A1890ES	1880 - 1900	5±1	3.15	2.4
CP0805A2442ES	2400 - 2484	4±1	4.2	2.4

Important: Couplers can be used at any frequency within the indicated range.

# Thin-Film RF/Microwave Directional Couplers

## CP0302/CP0402/CP0603/CP0805 and DB0603N/DB0805 3dB 90°

### CP0805 Layout Types

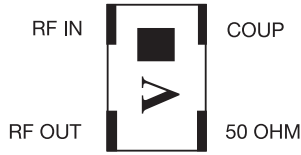

**Type: B**  
**Sub-Type: B**

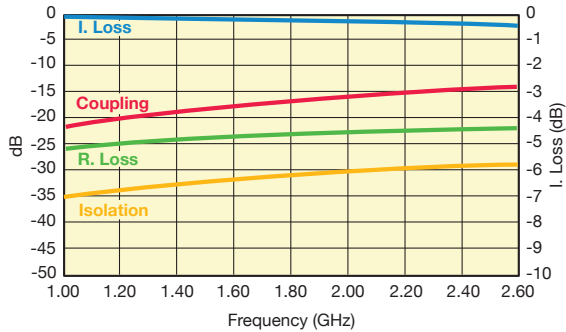

P/N Examples	Frequency Band [MHz]	Coupling [dB]	I. Loss max	VSWR max
CP0805B0836BS	824 - 849	23.5±1	0.25	1.2
CP0805B0881BS	869 - 894	23±1	0.25	1.2
CP0805B0902BS	890 - 915	22.5±1	0.25	1.2
CP0805B0947BS	935 - 960	22±1	0.25	1.2
CP0805B0897BS	880 - 915	23±1	0.25	1.2
CP0805B0942BS	925 - 960	22±1	0.25	1.2
CP0805B1441BS	1429 - 1453	18.5±1	0.25	1.2
CP0805B1747BS	1710 - 1785	17±1	0.25	1.2
CP0805B1842BS	1805 - 1880	16.5±1	0.25	1.2
CP0805B1880BS	1850 - 1910	16.5±1	0.25	1.2
CP0805B1960BS	1930 - 1990	16±1	0.25	1.2
CP0805B1907BS	1895 - 1920	16±1	0.25	1.2
CP0805B1890BS	1880 - 1900	16±1	0.25	1.2
CP0805B2442BS	2400 - 2484	14±1	0.4	1.2



**Type: B**  
**Sub-Type: C**

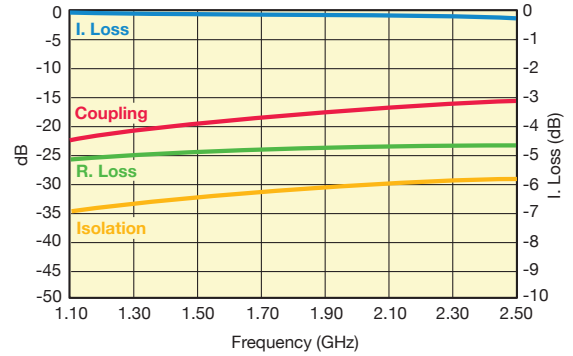

P/N Examples	Frequency Band [MHz]	Coupling [dB]	I. Loss max	VSWR max
CP0805B0836CS	824 - 849	25±1	0.25	1.2
CP0805B0881CS	869 - 894	24.5±1	0.25	1.2
CP0805B0902CS	890 - 915	24±1	0.25	1.2
CP0805B0947CS	935 - 960	24±1	0.25	1.2
CP0805B0897CS	880 - 915	24.5±1	0.25	1.2
CP0805B0942CS	925 - 960	24±1	0.25	1.2
CP0805B1441CS	1429 - 1453	20±1	0.25	1.2
CP0805B1747CS	1710 - 1785	18.5±1	0.25	1.2
CP0805B1842CS	1805 - 1880	18.5±1	0.25	1.2
CP0805B1880CS	1850 - 1910	18±1	0.25	1.2
CP0805B1960CS	1930 - 1990	17.5±1	0.25	1.2
CP0805B1907CS	1895 - 1920	18±1	0.25	1.2
CP0805B1890CS	1880 - 1900	18±1	0.25	1.2
CP0805B2442CS	2400 - 2484	16±1	0.4	1.2

**Type: B**  
**Sub-Type: B**

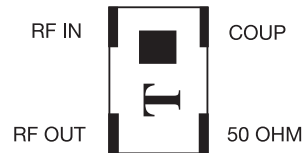
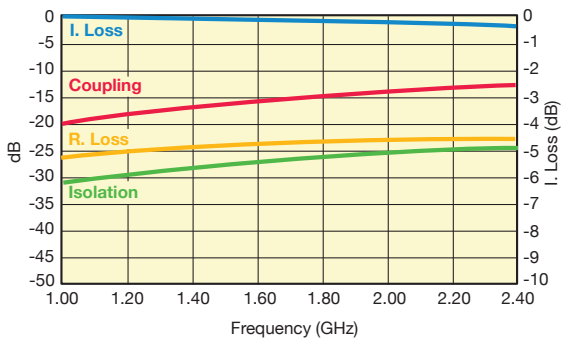

P/N Examples	Frequency Band [MHz]	Coupling [dB]	I. Loss max	VSWR max
CP0805B0836AS	824 - 849	21.5±1	0.25	1.2
CP0805B0881AS	869 - 894	21±1	0.25	1.2
CP0805B0902AS	890 - 915	21±1	0.25	1.2
CP0805B0947AS	935 - 960	20.5±1	0.25	1.2
CP0805B0897AS	880 - 915	21±1	0.25	1.2
CP0805B0942AS	925 - 960	20.5±1	0.25	1.2
CP0805B1441AS	1429 - 1453	17±1	0.25	1.2
CP0805B1747AS	1710 - 1785	15.5±1	0.25	1.2
CP0805B1842AS	1805 - 1880	15.5±1	0.3	1.2
CP0805B1880AS	1850 - 1910	15±1	0.3	1.2
CP0805B1960AS	1930 - 1990	14.5±1	0.4	1.2
CP0805B1907AS	1895 - 1920	15±1	0.3	1.2
CP0805B1890AS	1880 - 1900	15±1	0.3	1.2
CP0805B2442AS	2400 - 2484	13±1	0.4	1.2

Important: Couplers can be used at any frequency within the indicated range.



The Important Information/Disclaimer is incorporated in the catalog where these specifications came from or available online at [www.avx.com/disclaimer/](http://www.avx.com/disclaimer/) by reference and should be reviewed in full before placing any order.

# Thin-Film RF/Microwave Directional Couplers

## CP0302/CP0402/CP0603/CP0805 and DB0603N/DB0805 3dB 90°

### CP0805 Layout Types



#### VHF DIRECTIONAL COUPLER CP0805L0155ASTR

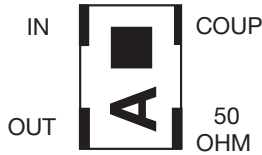

P/N	Frequency [MHz]	Coupling [dB]	R. Loss [dB]	I. Loss max [dB]	Directivity [dB]
CP0805L0155ASTR	155	17.1±1	24	0.35	22

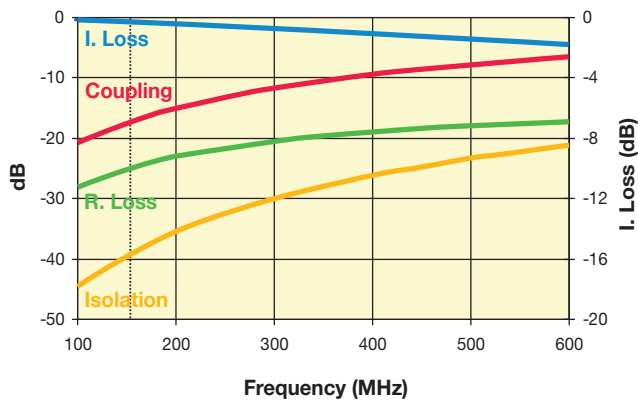

#### UHF DIRECTIONAL COUPLER CP0805L0436BSTR

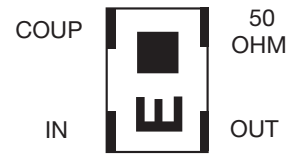

P/N	Frequency [MHz]	Coupling [dB]	R. Loss [dB]	I. Loss max [dB]	Directivity [dB]
CP0805L0436BSTR	403-470	15.85±1	35	0.25	22

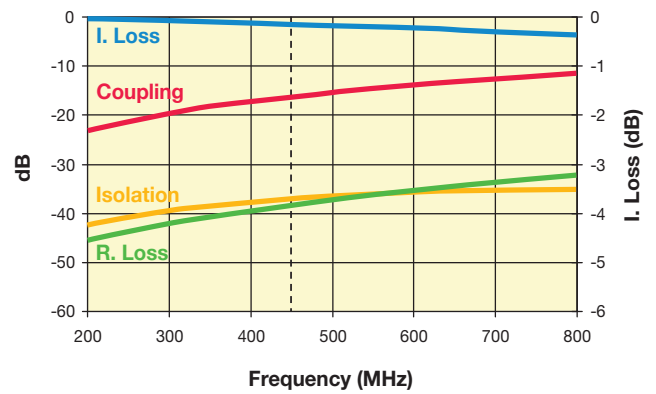

Important: Couplers can be used at any frequency within the indicated range.

# Thin-Film RF/Microwave Directional Couplers

## CP0302/CP0402/CP0603/CP0805 and DB0603N/DB0805 3dB 90°

### CP0805 and CP0603 Test Jig



#### ITF TEST JIG FOR COUPLER TYPES 0805 AND 0603 SMD

##### GENERAL DESCRIPTION

This jig is designed for the testing of CP0805 and CP0603 series Directional Couplers using a vector network analyzer.

It consists of a FR4 multi-layer substrate, having 50Ω microstrips as conducting lines and a ground plane in the middle layer, located at a distance of 0.2mm from the microstrips.

The connectors are SMA type (female), 'Johnson Components Inc.' Product P/N: 142-0701-881.

The jig is designed for a full 2-port calibration. LOAD calibration can be done either by a 50Ω SMA termination, or by soldering a 50Ω chip resistor at the 50Ω ports.

##### MEASUREMENT PROCEDURE

When measuring a component, it can be either soldered or pressed by a non-metallic stick until all four ports touch the appropriate pads. To measure the coupling (and the R. Loss) place the component on the Port 1 & Port 2 pads. Use two SMA 50Ω terminations (male) to terminate the ports, which are not connected to the network analyzer, and connect the network analyzer to the two ports. A 90° rotation of the component on its pads allows measuring a second parameter (I. Loss).

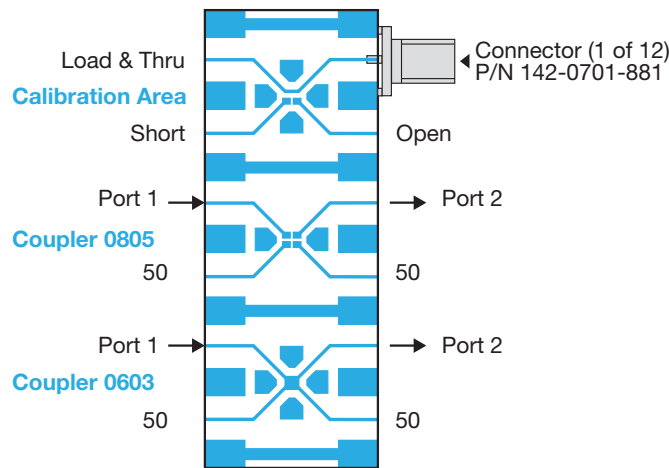

#### CP0805 SERIES DIRECTIONAL COUPLERS

##### Orientation and Tape and Reel Packaging Specification (Top View)

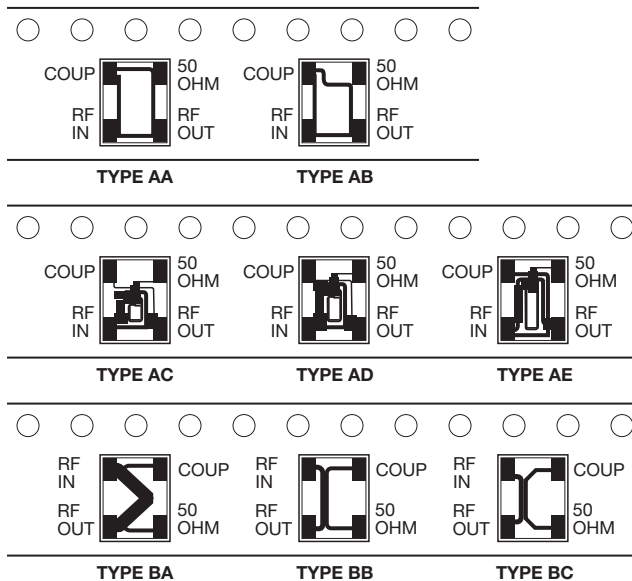

The parts should be mounted on the PCB with White (Alumina) side down and the "dark" side up.

##### CP0805xxxxxxSTR (Sn100)

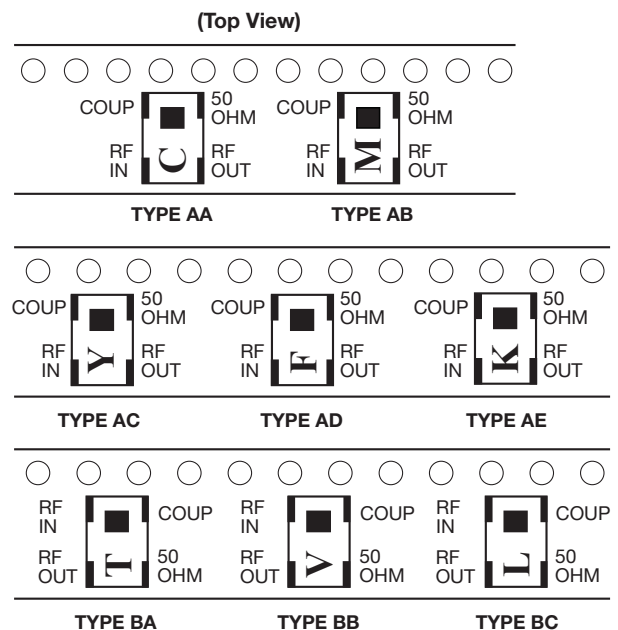

The parts should be mounted on the PCB with printed side up.

# Mouser Electronics

Authorized Distributor

Click to View Pricing, Inventory, Delivery & Lifecycle Information:

## KYOCERA AVX:

[CP0805B1441AWTR](#) [CP0805B2140CWTR](#) [CP0805A0947BWTR](#) [CP0805B1960CWTR](#) [CP0805B0836AWTR](#)  
[CP0805B1575CWTR](#) [CP0805A1960AWTR](#) [CP0805A0881ESTR](#) [CP0805A1441BSTR](#) [CP0805A0464EWTR](#)  
[CP0805A0836AWTR](#) [CP0805A0836DWTR](#) [CP0805A0881BWTR](#) [CP0805A0881CWTR](#) [CP0805A0881DWTR](#)  
[CP0805A1280BWTR](#) [CP0805A1747CWTR](#) [CP0805A1747DWTR](#) [CP0805A1880BWTR](#) [CP0805A1907AWTR](#)  
[CP0805A1960CWTR](#) [CP0805A1960DWTR](#) [CP0805A2442CWTR](#) [CP0805A2442DWTR](#) [CP0805B0881AWTR](#)  
[CP0805B0942AWTR](#) [CP0805B1100CWTR](#) [CP0805B1880AWTR](#) [CP0805B1880BWTR](#) [CP0805B1960AWTR](#)  
[CP0805B1960BWTR](#) [CP0805A2442EWTR](#) [CP0805A2442BWTR](#) [CP0805A0836BWTR](#) [CP0805A0836EWTR](#)  
[CP0805A0881AWTR](#) [CP0805A0881EWTR](#) [CP0805A0902AWTR](#) [CP0805A0902BWTR](#) [CP0805A0902CWTR](#)  
[CP0805A0902DWTR](#) [CP0805A0902EWTR](#) [CP0805A0942AWTR](#) [CP0805A0942BWTR](#) [CP0805A0942EWTR](#)  
[CP0805A0947AWTR](#) [CP0805A1441AWTR](#) [CP0805A1441BWTR](#) [CP0805A1550AWTR](#) [CP0805A1615BWTR](#)  
[CP0805A1720BWTR](#) [CP0805A1747AWTR](#) [CP0805A1842AWTR](#) [CP0805A1880AWTR](#) [CP0805A1890BWTR](#)  
[CP0805A1960BWTR](#) [CP0805A1975AWTR](#) [CP0805A1975BWTR](#) [CP0805B0836CWTR](#) [CP0805B0902AWTR](#)  
[CP0805B0902BWTR](#) [CP0805B0902CWTR](#) [CP0805B1441CWTR](#) [CP0805B1741AWTR](#) [CP0805B1747AWTR](#)  
[CP0805B1747BWTR](#) [CP0805B1747CWTR](#) [CP0805B1765AWTR](#) [CP0805B1842AWTR](#) [CP0805B1842BWTR](#)  
[CP0805B1842CWTR](#) [CP0805B1880CWTR](#) [CP0805B1890AWTR](#) [CP0805B1890BWTR](#) [CP0805B1890CWTR](#)  
[CP0805B1907AWTR](#) [CP0805B1907BWTR](#) [CP0805B1916CWTR](#) [CP0805B1950CWTR](#) [CP0805B1975CWTR](#)  
[CP0805B2442AWTR](#) [CP0805B2442BSTR](#) [CP0805B2442BWTR](#) [CP0805B2442CWTR](#) [CP0805A1842ASTR](#)  
[CP0805A0836CWTR](#) [CP0805A0897BWTR](#) [CP0805A1880CWTR](#) [CP0805A1880EWTR](#) [CP0805B3000AWTR](#)  
[CP0805B3000BWTR](#) [CP0805D0837VWTR](#) [CP0805A0897AWTR](#) [CP0805D0836VWTR](#) [CP0805A1907EWTR](#)  
[CP0805A2600BWTR](#) [CP0805A1890BWTR\500](#) [CP0805B0942AWTR\500](#) [CP0805A1280BWTR\500](#)  
[CP0805L0436BSTR](#)