

Features

- Epitaxial Die Construction
- Two Internally Isolated NPN/PNP Transistors in One Package
- Ultra-Small Surface Mount Package
- **Totally Lead-Free & Fully RoHS Compliant (Notes 1 & 2)**
- **Halogen- and Antimony-Free. "Green" Device (Note 3)**
- **For automotive applications requiring specific change control (i.e. parts qualified to AEC-Q100/101/200, PPAP capable, and manufactured in IATF 16949 certified facilities), please [contact us](#) or your local Diodes representative. <https://www.diodes.com/quality/product-definitions/>**
- **An Automotive-Compliant Part Is Available Under Separate Datasheet ([BC847BVNQ](#))**

Mechanical Data

- Surface Mount Package
- Weight: 0.003 grams (Approximate)
- Max Soldering Temperature +260°C for 30 secs as per JEDEC J-STD-020
- Case Material – Molded Plastic, UL Flammability Rating 94V-0
- Terminals: Finish – Matte Tin Plated Leads, Solderable
- per MIL-STD-202, Method 208

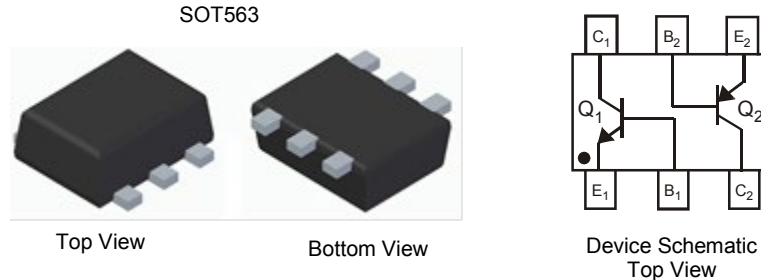

Ordering Information (Note 4)

Part Number	Compliance	Marking	Reel Size (inches)	Tape Width (mm)	Quantity per Reel
BC847BVN-7	Standard	KAW	7	8	3,000

- Notes:
1. No purposely added lead. Fully EU Directive 2002/95/EC (RoHS), 2011/65/EU (RoHS 2) & 2015/863/EU (RoHS 3) compliant.
 2. See <https://www.diodes.com/quality/lead-free/> for more information about Diodes Incorporated's definitions of Halogen- and Antimony-free, "Green" and Lead-free.
 3. Halogen- and Antimony-free "Green" products are defined as those which contain <900ppm bromine, <900ppm chlorine (<1500ppm total Br + Cl) and <1000ppm antimony compounds.
 4. For packaging details, go to our website at <https://www.diodes.com/design/support/packaging/diodes-packaging/>.

Marking Information

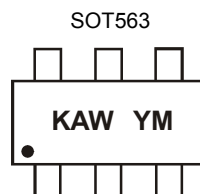

KAW = Product Type Marking Code
 YM = Date Code Marking
 Y = Year (ex: H = 2020)
 M = Month (ex: 9 = September)

Date Code Key

Year	2020	2021	2022	2023	2024	2025	2026	2027	2028	2029	2030	2031
Code	H	I	J	K	L	M	N	O	P	R	S	T

Month	Jan	Feb	Mar	Apr	May	Jun	Jul	Aug	Sep	Oct	Nov	Dec
Code	1	2	3	4	5	6	7	8	9	O	N	D

Maximum Ratings: NPN, BC847B Type (Q₁) (@ T_A = +25°C, unless otherwise specified.)

Characteristic	Symbol	Value	Unit
Collector-Base Voltage	V _{CB0}	50	V
Collector-Emitter Voltage	V _{CEO}	45	V
Emitter-Base Voltage	V _{EBO}	6	V
Collector Current	I _C	100	mA
Peak Pulse Collector Current (single pulse)	I _{CM}	200	mA
Peak Pulse Emitter Current (single pulse)	I _{EM}	200	mA

Maximum Ratings: PNP, BC857B Type (Q₂) (@ T_A = +25°C unless otherwise specified.)

Characteristic	Symbol	Value	Unit
Collector-Base Voltage	V _{CB0}	-50	V
Collector-Emitter Voltage	V _{CEO}	-45	V
Emitter-Base Voltage	V _{EBO}	-6	V
Collector Current	I _C	-100	mA
Peak Pulse Collector Current (single pulse)	I _{CM}	-200	mA
Peak Pulse Emitter Current (single pulse)	I _{EM}	-200	mA

Thermal Characteristics – Total Device (@ T_A = +25°C unless otherwise specified.)

Characteristic	Symbol	Value	Unit
Power Dissipation (Note 5) Total Device	P _D	150	mW
Thermal Resistance, Junction to Ambient (Note 5)	R _{θJA}	833	°C/W
Operating and Storage Temperature Range	T _J , T _{STG}	-55 to +150	°C

Note: 5. For a device surface mounted on minimum recommended pad layout FR-4 PCB with single sided 1oz copper, in still air conditions; the device is measured when operating in a steady-state condition.

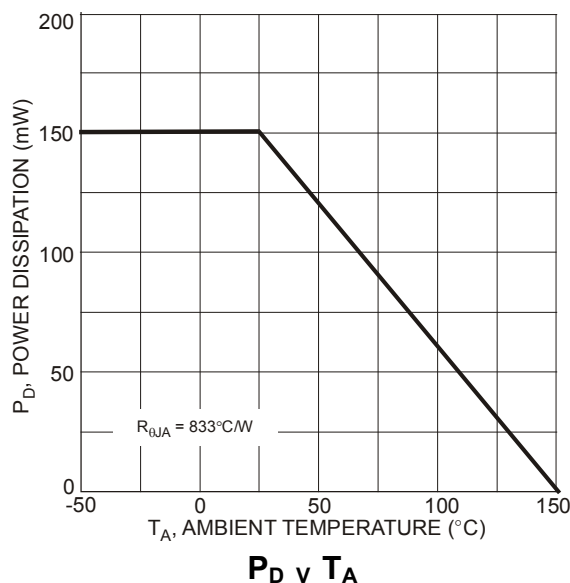
Thermal Characteristics – Total Device

Electrical Characteristics: NPN, BC847B Type (Q₁) (@ T_A = +25°C unless otherwise specified.)

Characteristic (Note 6)	Symbol	Min	Typ	Max	Unit	Test Condition
Collector-Base Breakdown Voltage	BV _{CB0}	50	—	—	V	I _C = 100μA, I _B = 0
Collector-Emitter Breakdown Voltage	BV _{CEO}	45	—	—	V	I _C = 10mA, I _B = 0
Emitter-Base Breakdown Voltage	BV _{EBO}	6	—	—	V	I _E = 100μA, I _C = 0
DC Current Gain	h _{FE}	200	290	450	—	V _{CE} = 5.0V, I _C = 2.0mA
Collector-Emitter Saturation Voltage	V _{CE(sat)}	—	90	250	mV	I _C = 10mA, I _B = 0.5mA I _C = 100mA, I _B = 5.0mA
Base-Emitter Saturation Voltage	V _{BE(sat)}	—	700	—	mV	I _C = 10mA, I _B = 0.5mA I _C = 100mA, I _B = 5.0mA
Base-Emitter Voltage	V _{BE(on)}	580	660	700	mV	V _{CE} = 5.0V, I _C = 2.0mA V _{CE} = 5.0V, I _C = 10mA
Collector Cut Off Current	I _{CB0}	—	—	15	nA	V _{CB} = 30V
		—	—	5.0	μA	V _{CB} = 30V, T _A = +150°C
Transition Frequency	f _T	100	300	—	MHz	V _{CE} = 5.0V, I _C = 10mA, f = 100MHz
Collector-Base Capacitance	C _{cbo}	—	3.5	6.0	pF	V _{CB} = 10V, f = 1.0MHz

Note: 6. Short duration pulse test used to minimize self-heating effect.

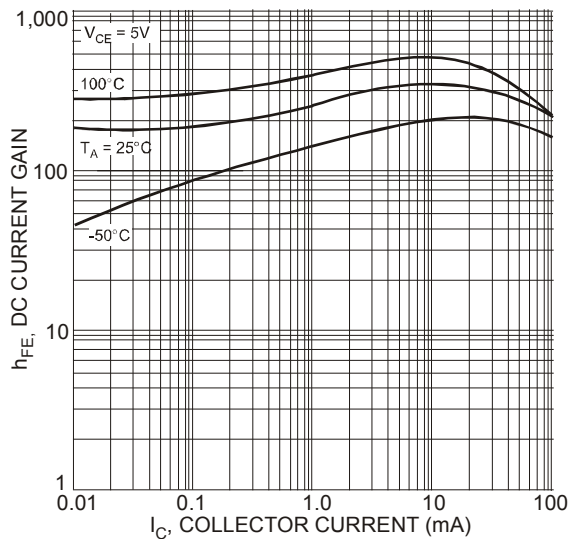

h_{FE} v I_C

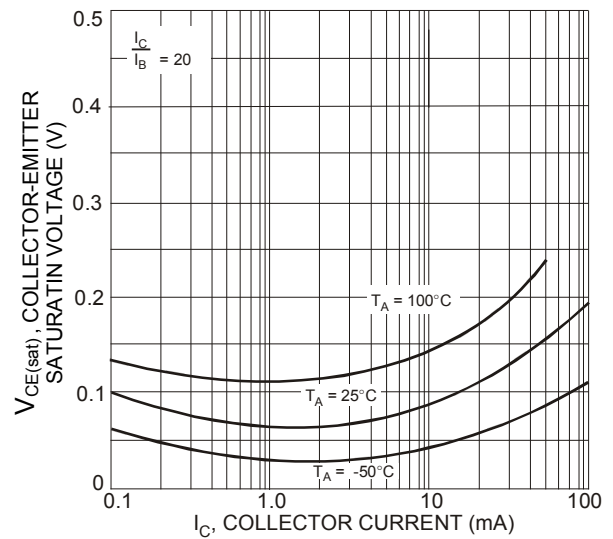

V_{CE(sat)} v I_C

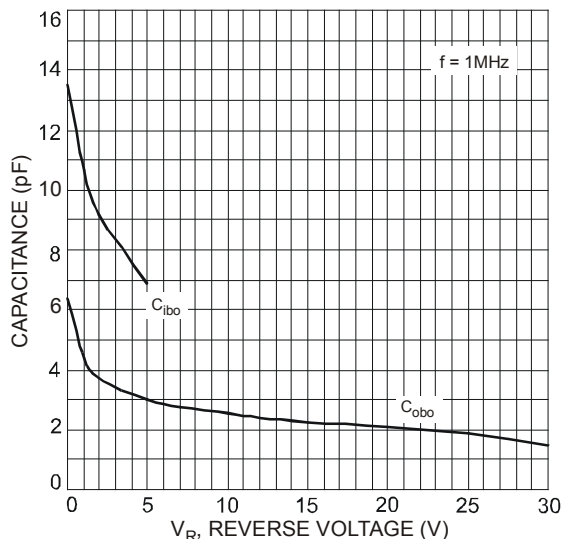

C v V_R

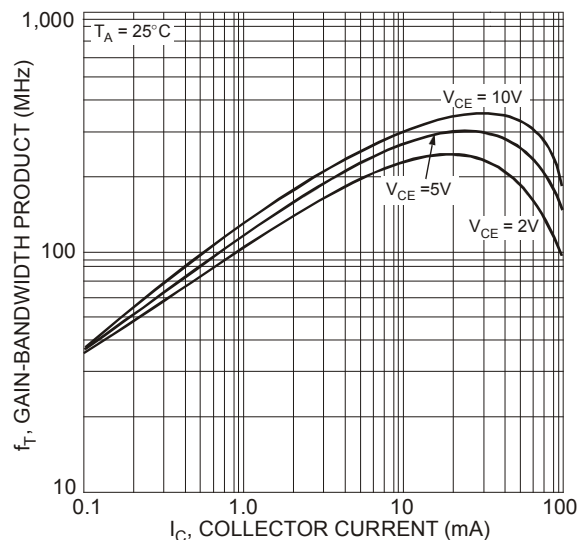

f_T v I_C

Electrical Characteristics: PNP, BC857B Type (Q₂) (@T_A = +25°C unless otherwise specified.)

Characteristic (Note 7)	Symbol	Min	Typ	Max	Unit	Test Condition
Collector-Base Breakdown Voltage	BV _{CBO}	-50	—	—	V	I _C = -100μA, I _B = 0
Collector-Emitter Breakdown Voltage	BV _{CEO}	-45	—	—	V	I _C = -10mA, I _B = 0
Emitter-Base Breakdown Voltage	BV _{EBO}	-6	—	—	V	I _E = -100μA, I _C = 0
DC Current Gain	h _{FE}	220	290	475	—	V _{CE} = -5.0V, I _C = -2.0mA
Collector-Emitter Saturation Voltage	V _{CE(sat)}	—	-75 -250	-300 -650	mV	I _C = -10mA, I _B = -0.5mA I _C = -100mA, I _B = -5.0mA
Base-Emitter Saturation Voltage	V _{BE(sat)}	—	-700 -850	— -950	mV	I _C = -10mA, I _B = -0.5mA I _C = -100mA, I _B = -5.0mA
Base-Emitter Voltage	V _{BE(on)}	-600	-650	-750 -820	mV	V _{CE} = -5.0V, I _C = -2.0mA V _{CE} = -5.0V, I _C = -10mA
Collector Cut Off Current	I _{CBO}	—	—	-15 -4.0	nA μA	V _{CB} = -30V V _{CB} = -30V, T _A = +150°C
Transition frequency	f _T	100	200	—	MHz	V _{CE} = -5.0V, I _C = -10mA, f = 100MHz
Collector-Base Capacitance	C _{cbo}	—	3	4.5	pF	V _{CB} = -10V, f = 1.0MHz

Note: 7. Short duration pulse test used to minimize self-heating effect.

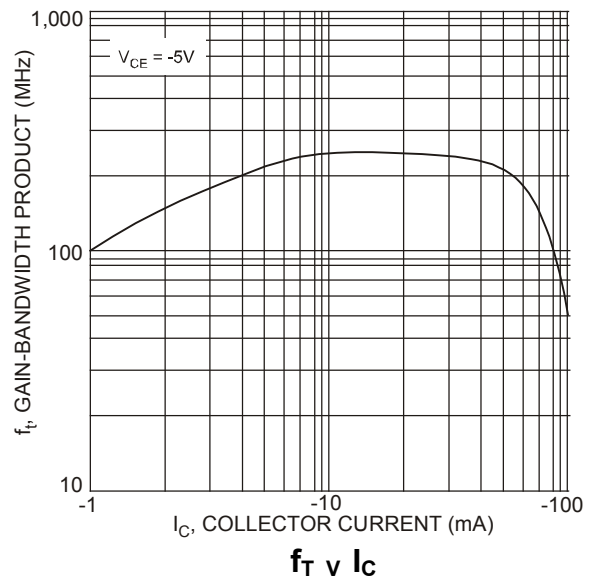
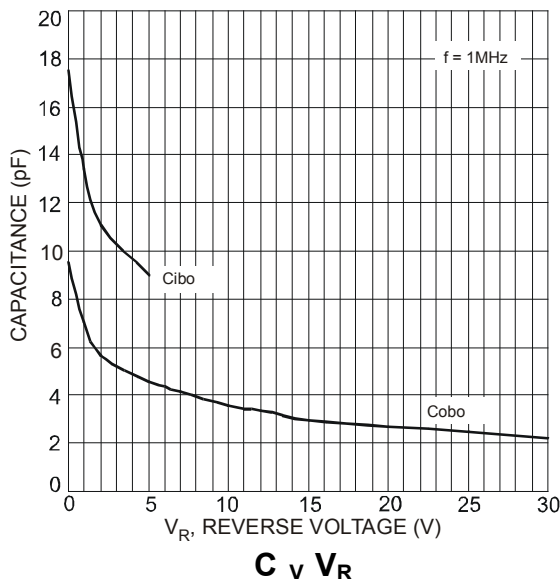
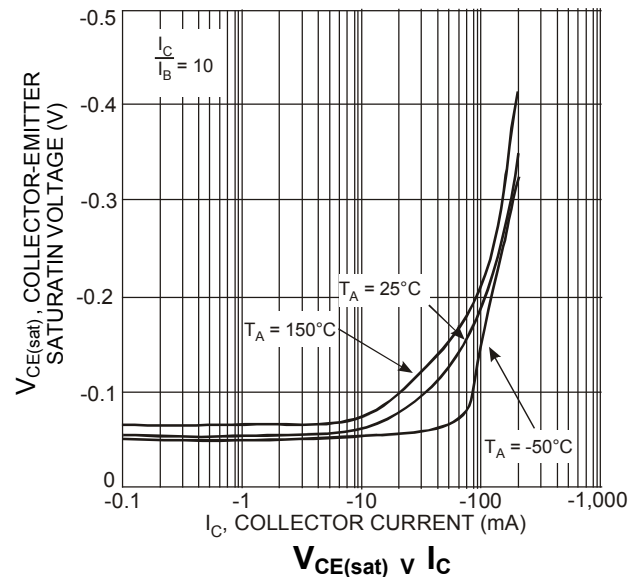
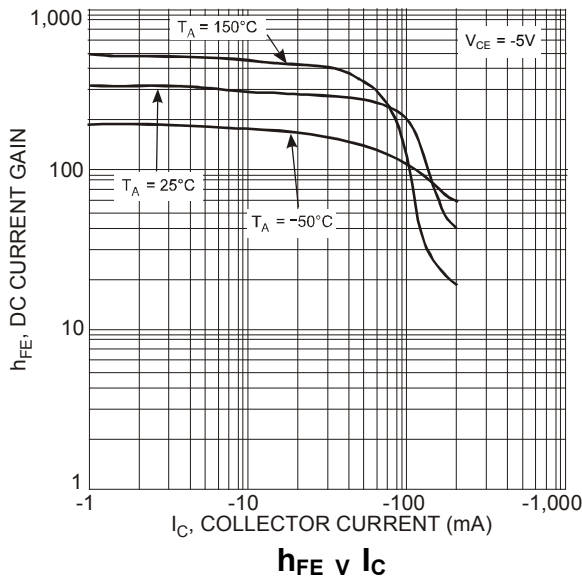

Package Outline Dimensions

Please see <http://www.diodes.com/package-outlines.html> for the latest version.

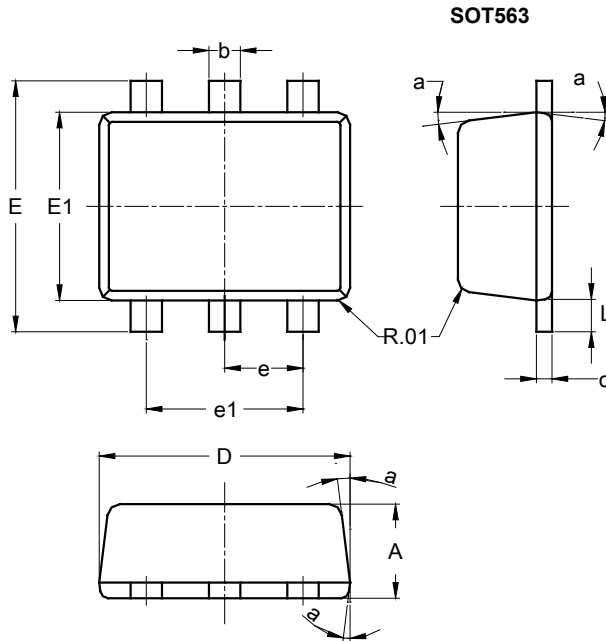

SOT563			
Dim	Min	Max	Typ
A	0.55	0.60	0.60
b	0.15	0.30	0.20
c	0.10	0.18	0.11
D	1.50	1.70	1.60
E	1.55	1.70	1.60
E1	1.10	1.25	1.20
e	--	--	0.50
e1	0.90	1.10	1.00
L	0.10	0.30	0.20
a	8°	9°	7°
All Dimensions in mm			

Suggested Pad Layout

Please see <http://www.diodes.com/package-outlines.html> for the latest version.

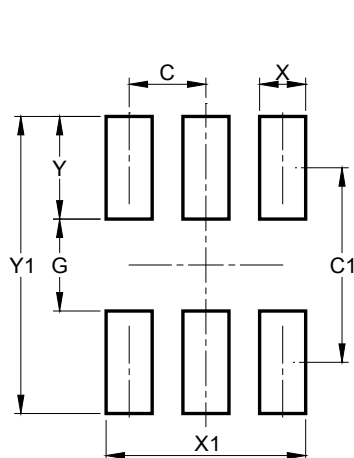

Dimensions	Value (in mm)
C	0.500
C1	1.270
G	0.600
X	0.300
X1	1.300
Y	0.670
Y1	1.940

IMPORTANT NOTICE

1. DIODES INCORPORATED AND ITS SUBSIDIARIES (“DIODES”) MAKE NO WARRANTY OF ANY KIND, EXPRESS OR IMPLIED, WITH REGARDS TO ANY INFORMATION CONTAINED IN THIS DOCUMENT, INCLUDING, BUT NOT LIMITED TO, THE IMPLIED WARRANTIES OF MERCHANTABILITY, FITNESS FOR A PARTICULAR PURPOSE OR NON-INFRINGEMENT OF THIRD PARTY INTELLECTUAL PROPERTY RIGHTS (AND THEIR EQUIVALENTS UNDER THE LAWS OF ANY JURISDICTION).
2. The Information contained herein is for informational purpose only and is provided only to illustrate the operation of Diodes products described herein and application examples. Diodes does not assume any liability arising out of the application or use of this document or any product described herein. This document is intended for skilled and technically trained engineering customers and users who design with Diodes products. Diodes products may be used to facilitate safety-related applications; however, in all instances customers and users are responsible for (a) selecting the appropriate Diodes products for their applications, (b) evaluating the suitability of the Diodes products for their intended applications, (c) ensuring their applications, which incorporate Diodes products, comply the applicable legal and regulatory requirements as well as safety and functional-safety related standards, and (d) ensuring they design with appropriate safeguards (including testing, validation, quality control techniques, redundancy, malfunction prevention, and appropriate treatment for aging degradation) to minimize the risks associated with their applications.
3. Diodes assumes no liability for any application-related information, support, assistance or feedback that may be provided by Diodes from time to time. Any customer or user of this document or products described herein will assume all risks and liabilities associated with such use, and will hold Diodes and all companies whose products are represented herein or on Diodes’ websites, harmless against all damages and liabilities.
4. Products described herein may be covered by one or more United States, international or foreign patents and pending patent applications. Product names and markings noted herein may also be covered by one or more United States, international or foreign trademarks and trademark applications. Diodes does not convey any license under any of its intellectual property rights or the rights of any third parties (including third parties whose products and services may be described in this document or on Diodes’ website) under this document.
5. Diodes products are provided subject to Diodes’ Standard Terms and Conditions of Sale (<https://www.diodes.com/about/company/terms-and-conditions/terms-and-conditions-of-sales/>) or other applicable terms. This document does not alter or expand the applicable warranties provided by Diodes. Diodes does not warrant or accept any liability whatsoever in respect of any products purchased through unauthorized sales channel.
6. Diodes products and technology may not be used for or incorporated into any products or systems whose manufacture, use or sale is prohibited under any applicable laws and regulations. Should customers or users use Diodes products in contravention of any applicable laws or regulations, or for any unintended or unauthorized application, customers and users will (a) be solely responsible for any damages, losses or penalties arising in connection therewith or as a result thereof, and (b) indemnify and hold Diodes and its representatives and agents harmless against any and all claims, damages, expenses, and attorney fees arising out of, directly or indirectly, any claim relating to any noncompliance with the applicable laws and regulations, as well as any unintended or unauthorized application.
7. While efforts have been made to ensure the information contained in this document is accurate, complete and current, it may contain technical inaccuracies, omissions and typographical errors. Diodes does not warrant that information contained in this document is error-free and Diodes is under no obligation to update or otherwise correct this information. Notwithstanding the foregoing, Diodes reserves the right to make modifications, enhancements, improvements, corrections or other changes without further notice to this document and any product described herein. This document is written in English but may be translated into multiple languages for reference. Only the English version of this document is the final and determinative format released by Diodes.
8. Any unauthorized copying, modification, distribution, transmission, display or other use of this document (or any portion hereof) is prohibited. Diodes assumes no responsibility for any losses incurred by the customers or users or any third parties arising from any such unauthorized use.

Copyright © 2021 Diodes Incorporated

www.diodes.com

Mouser Electronics

Authorized Distributor

Click to View Pricing, Inventory, Delivery & Lifecycle Information:

[Diodes Incorporated:](#)

[BC847BVN-7](#)