

This drawing is copyright. Information contained thereon is supplied in confidence and must not be used for any other purpose than which it was supplied, or be reproduced without written permission of the owners.

Diese Zeichnung ist unser geistiges Eigentum und darf ohne unsere ausdrückliche Einwilligung weder kopiert, vervielfältigt, noch Dritten oder Konkurrenzfirmen zugänglich gemacht werden.

type : 11 TNC-50-7-2

	date	sign
drawn	03.05.01	4469/KRI
checked	03.05.01	4728/KRI
approved	03.05.01	4728/KRI

cable shortening dimension

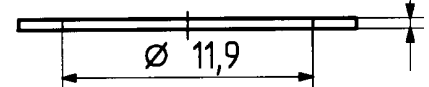
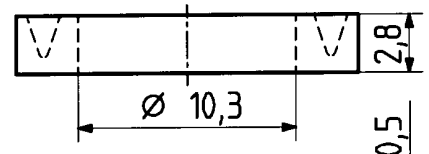
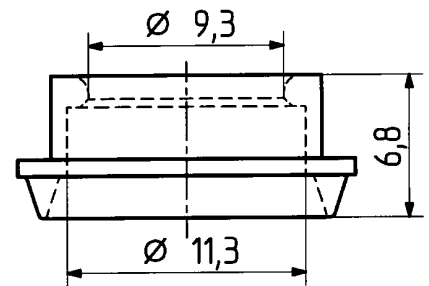
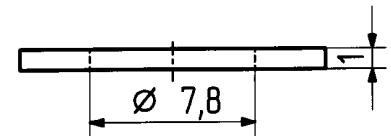
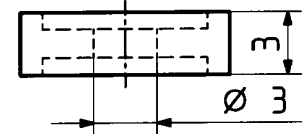
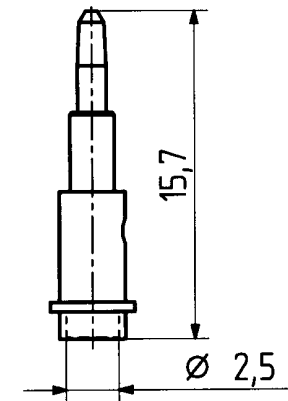
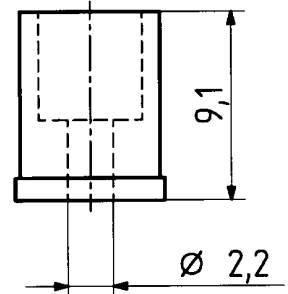
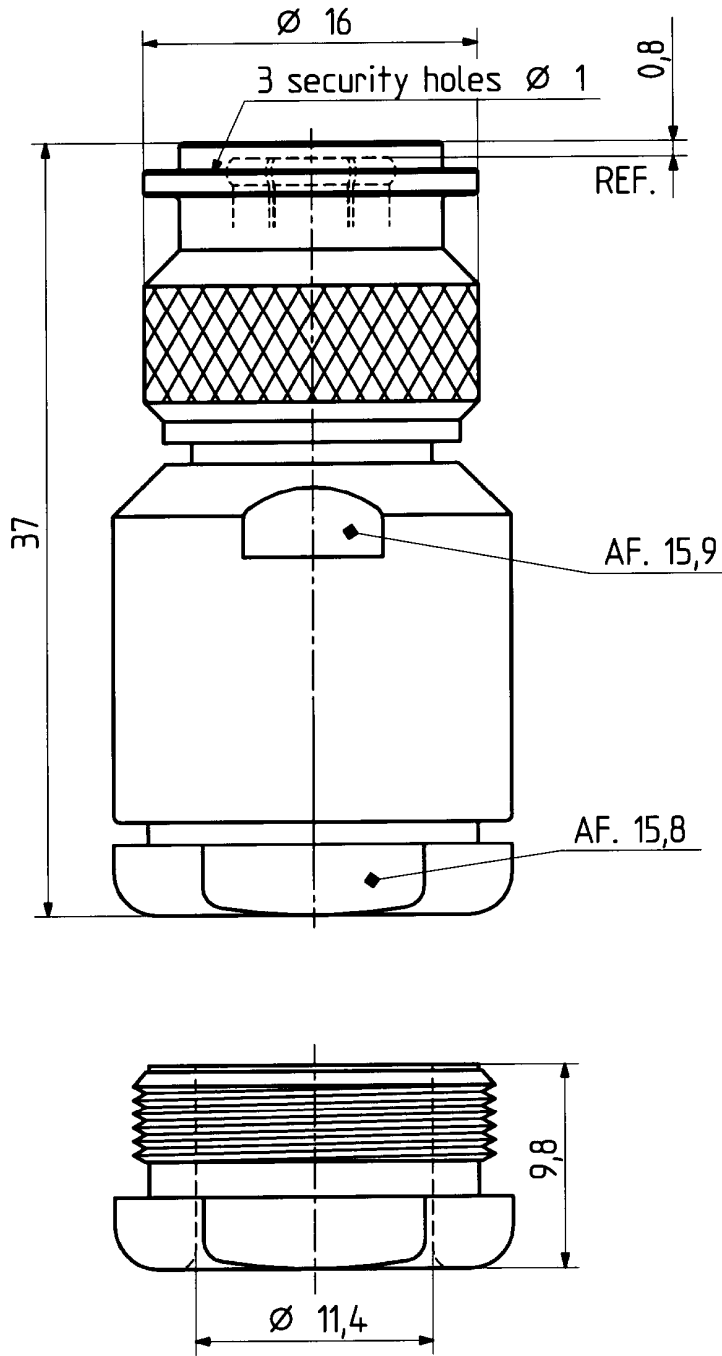
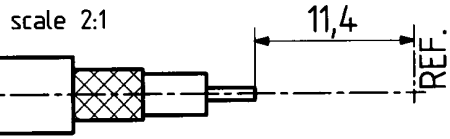

H+S 701 4468.05

scale

3:1



HUBER + SUHNER
CH-ITC-RBS-CON

dimensions in mm

drawing number

4.13.33285

OZ drawing : OZ.

Index

b