



Data sheet Product MSVL 85



Accessories for electronic components > Fixing material for mechanical components > Guide rails

* = position of snap-in slot

Features

type of mounting	screw-on type
version	with bolting device
material	polyamide, GF reinforced
temperature range	-40°C... +205°C
class of flammability	UL 94 V-0

Technical Drawing

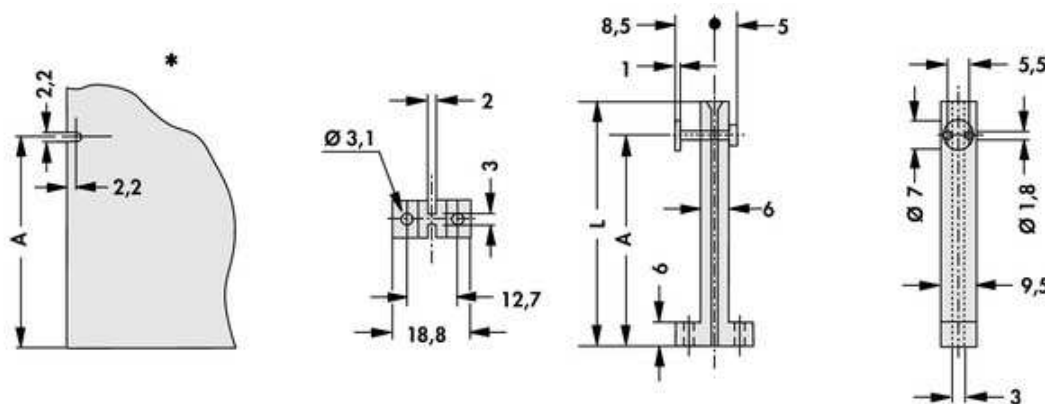

L	85
L [mm]	
height	76
A [mm]	

Fischer Elektronik GmbH & Co. KG
DEUTSCHLAND • GERMANY • ALLEMAGNE

Nottebohmstraße 28
58511 Lüdenscheid

Telefon +49 2351 435-0
Telefax +49 2351 45754

info@fischerelektronik.de
www.fischerelektronik.de