

# EasyPIC Fusion<sup>v7</sup>

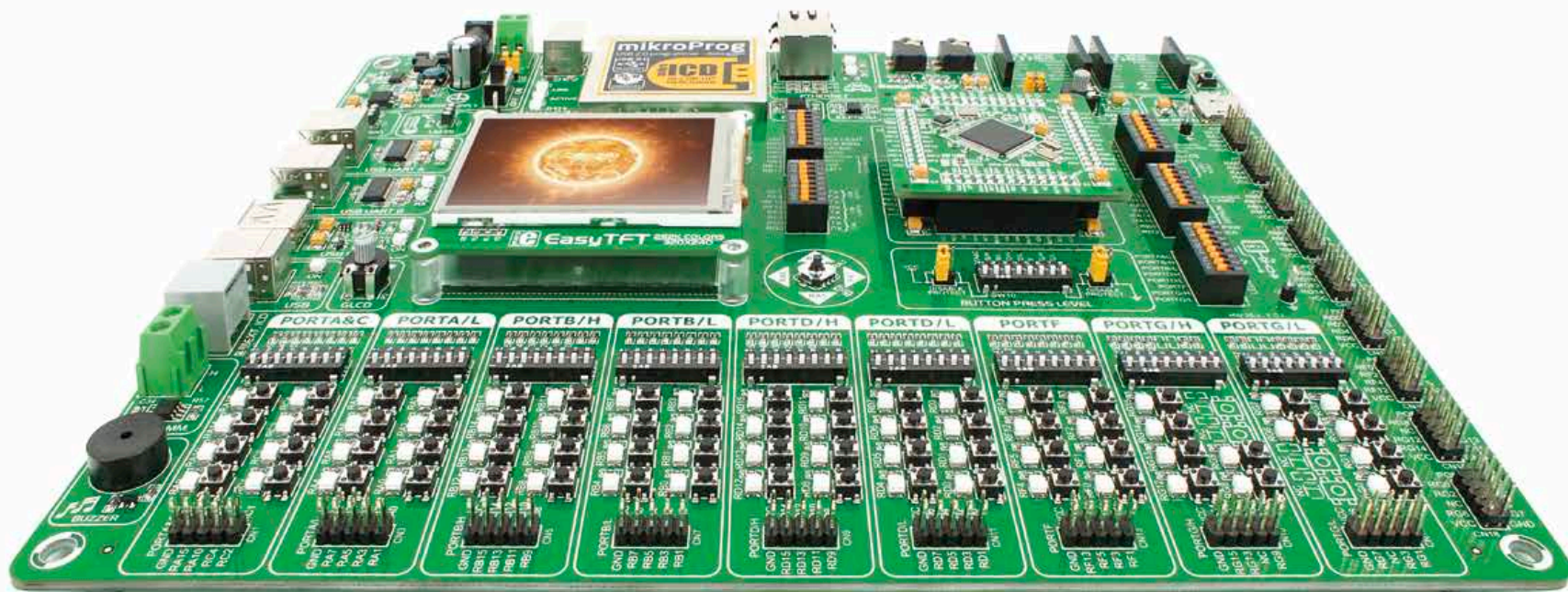

65

microcontrollers supported  
PIC24<sup>®</sup>, dsPIC33<sup>®</sup> and pic32<sup>®</sup>



Many on-board modules  
Multimedia peripherals



Easy-add extra boards  
mikroBUS<sup>™</sup> sockets

connectivity



Two connectors for each port  
Amazing Connectivity



Fast USB 2.0 programmer and  
In-Circuit Debugger

# To our valued customers

Providing our users the ability to easily switch between architectures on the same development board has always been an engineering challenge for us. But we have mastered this technology during the past decade and now we present you the revolutionary board that combines support for three different microcontroller families: Microchip's dsPIC33®, PIC24® and PIC32®. EasyPIC Fusion™ v7 is the ultimate board for all of your 16-bit and 32-bit PIC projects.

You made the right choice.



Nebojsa Matic,  
Owner and General Manager  
of MikroElektronika

# Table of contents

## Introduction

Introduction .....	04
It's good to know .....	05

## Power Supply

Power supply .....	06
--------------------	----

## Supported MCUs

MCU cards .....	08
Other supported MCU cards .....	11

## Programmer/debugger

On-board programmer .....	12
Installing programmer drivers .....	14
Programming software .....	15
mikroLCD™ .....	16

## Connectivity

Input/Output Group .....	18
mikroBUS™ sockets .....	20
Click™ Boards .....	21

## Communication

USB-UART A .....	22
USB-UART B .....	23
USB host .....	24
USB device .....	25
Ethernet communication .....	26
CAN communication .....	27

## Multimedia

Audio Input/Output .....	28
microSD card slot .....	29
TFT display 320x240 pixels .....	30
Touch panel controller .....	31
Navigation switch .....	32
Piezo Buzzer .....	33

## Other Modules

DS1820 - Digital Temperature Sensor .....	34
LM35 - Analog Temperature Sensor .....	35
Serial Flash Memory .....	36
I2C EEPROM .....	37
ADC inputs .....	38
Additional GNDs .....	39

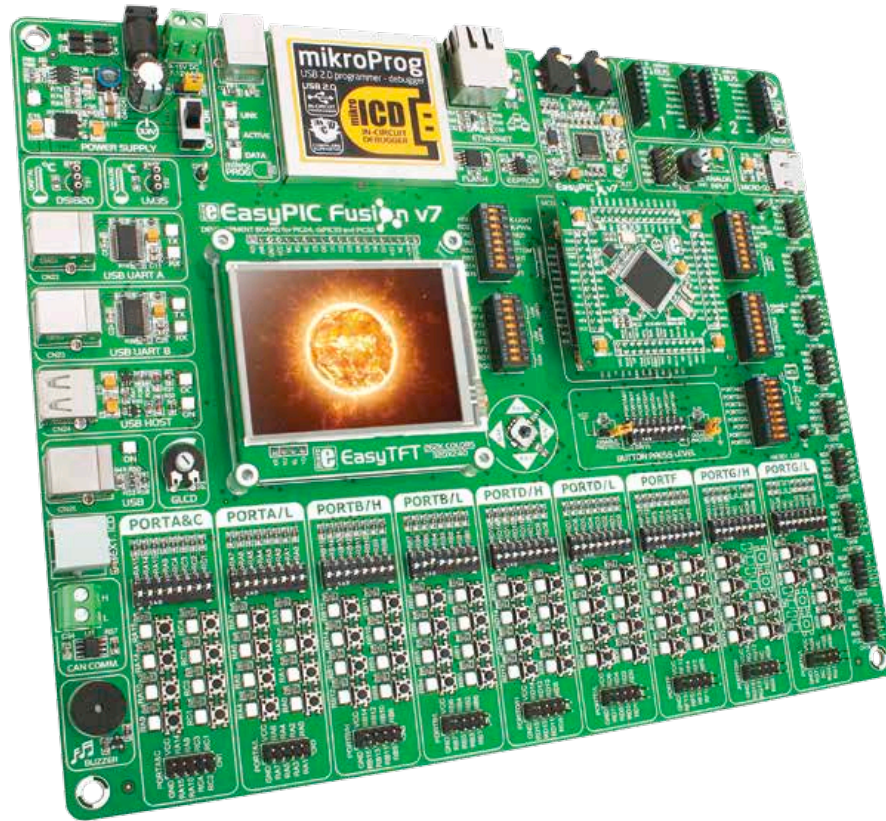

# Introduction

EasyPIC Fusion™ v7 is the first board of it's kind to combine support for three popular Microchip® low-power microcontroller architectures in one place. We wanted to put as many peripherals on the board as possible, to cover many internal modules. We have gone through a process of fine tuning the board performance, and used 4-layer PCB to achieve maximum efficiency. Finally, it had met all of our expectations, and even exceeded in some. We present you the board which is powerful, well organized, with on-board programmer and debugger and is ready to be your strong ally in development.

*EasyPIC Fusion™ v7 development Team*

One board for three architectures  
dsPIC33, PIC24 & PIC32

For the first time we combined the power of three separate boards in one ultimate board for high performance Microchip MCUs. Developers now have the new scalability like never before.



Everything is already here  
mikroProg™ on board

Powerful on-board mikroProg™ programmer and In-Circuit debugger supports over 65 microcontrollers. It features fast enhanced programming and rich set of debugging instructions.

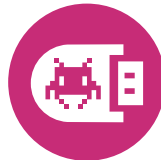

Ready for all kinds of development  
Multimedia peripherals

TFT 320x240 with touch panel, stereo mp3 codec, audio input and output, navigation switch and microSD card slot make a perfect set of peripherals for multimedia development.



For easier connections  
mikroBUS™ support

This innovative new socket allows you to use dozens of Click accessory boards with almost no hardware adjustments. Adding new functionality to your device was never so easy.





# It's good to know

## System Specifications



**power supply**  
7-12V AC or 9-15V DC  
or via USB cable (5V DC)



**power consumption**  
~143mA (all modules are  
disconnected)

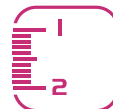

**board dimensions**  
266 x 220mm  
(10.47 x 8.66 inch)



**weight**  
~460g  
(1.014 lbs)

## Package contains



1 Damage resistant protective box

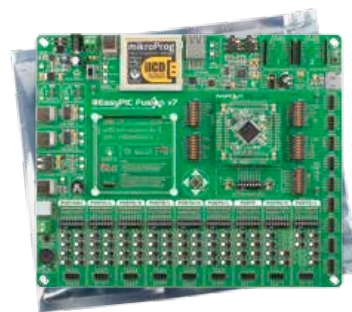

2 EasyPIC Fusion™ v7 board in antistatic bag



3 USB cable



5 User Manual



6 Board schematic



7 mikroICD™ and mikroProg Suite™ manual

# Power supply

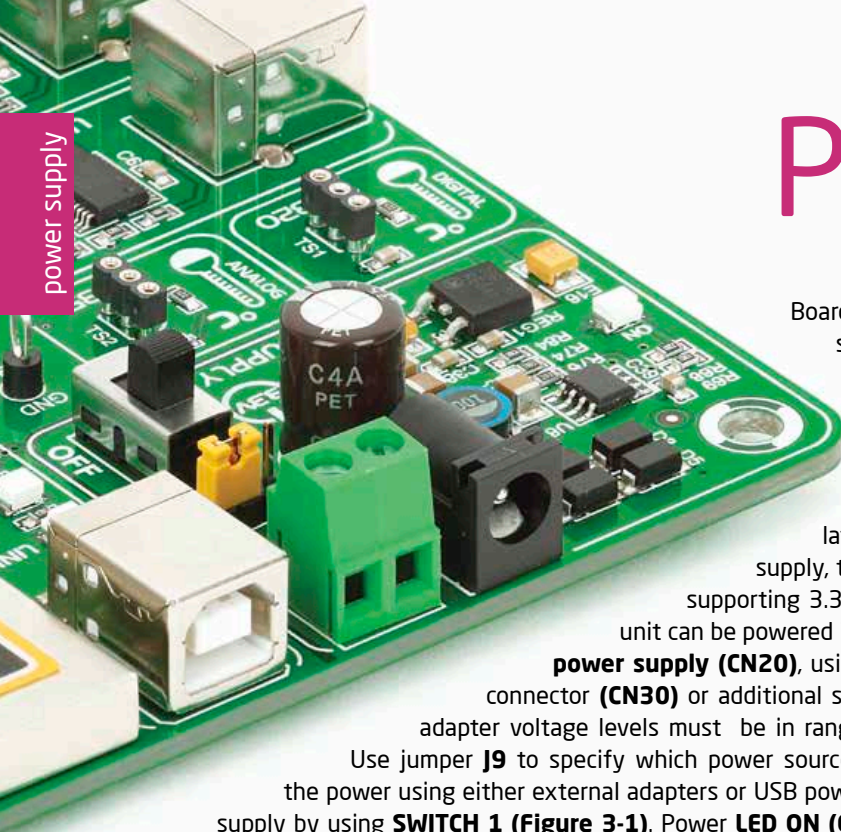

Board contains switching power supply that creates stable voltage and current levels necessary for powering each part of the board. Power supply section contains specialized **MC33269DT3.3** power regulator which creates VCC-3.3V power supply, thus making the board capable of supporting 3.3V microcontrollers. Power supply unit can be powered in three different ways: with **USB power supply (CN20)**, using external adapters via adapter connector (**CN30**) or additional screw terminals (**CN31**). External adapter voltage levels must be in range of **9-15V DC and 7-12V AC**. Use jumper **J9** to specify which power source you are using. Upon providing the power using either external adapters or USB power source you can turn on power supply by using **SWITCH 1 (Figure 3-1)**. Power **LED ON (Green)** indicates the presence of power supply.

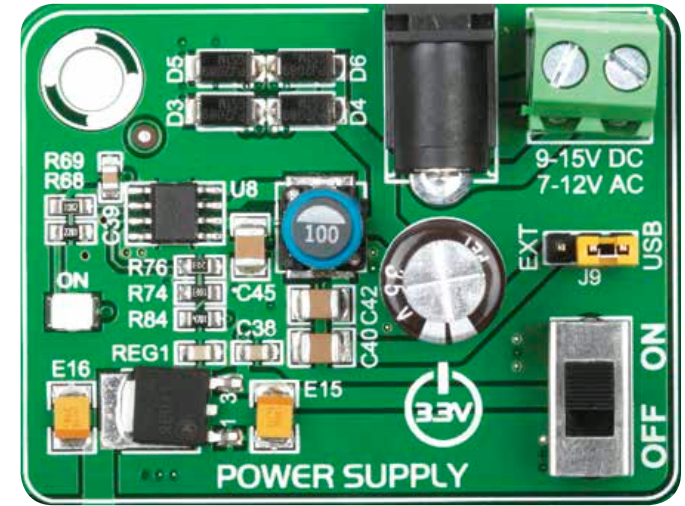
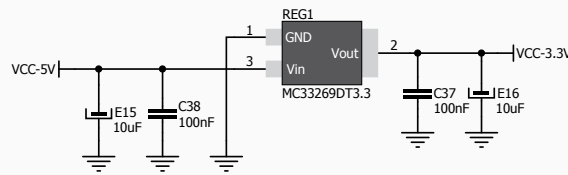

Figure 3-1: Power supply unit of EasyPIC Fusion™ v7



3.3V VOLTAGE REGULATOR

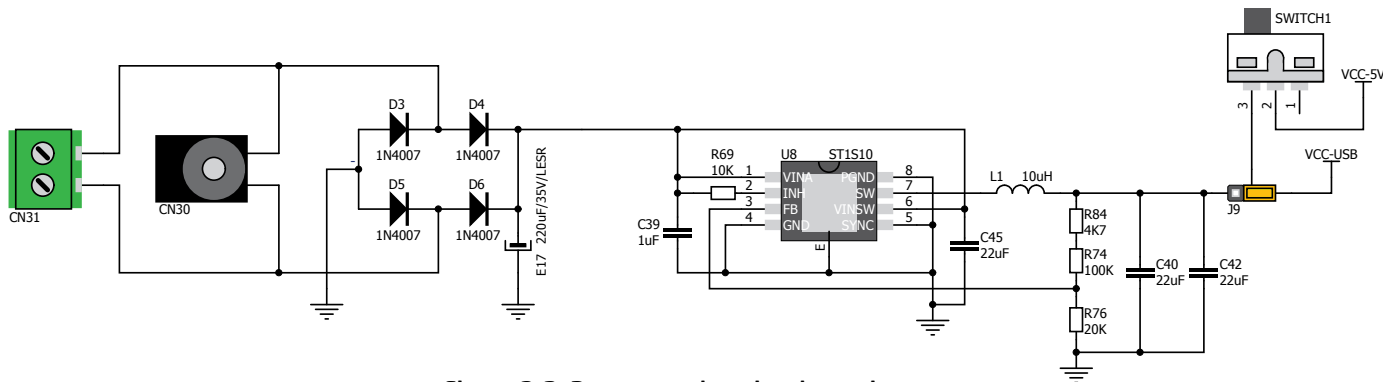
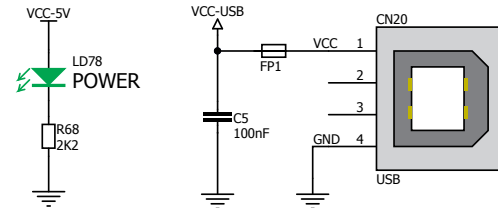

Figure 3-2: Power supply unit schematic



Board power supply creates stable 3.3V necessary for operation of the microcontroller and all on-board modules.

**Power supply:**

via DC connector or screw terminals (7V to 12V AC or 9V to 15V DC), or via USB cable (5V DC)

**Power capacity:**

up to 500mA with USB, and up to 1500mA with external power supply

## How to power the board?

### 1. With USB cable



Set J9 jumper to USB position

To power the board with USB cable, place jumper J9 in USB position. You can then plug in the USB cable as shown on images 1 and 2, and turn the power switch ON.

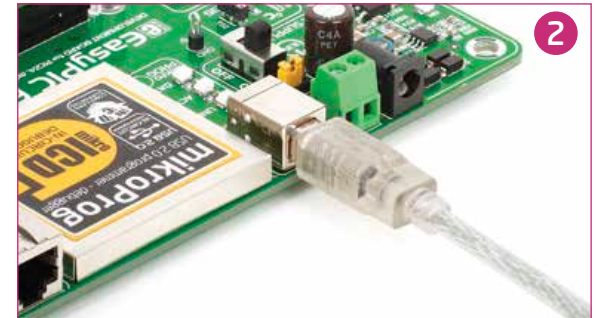
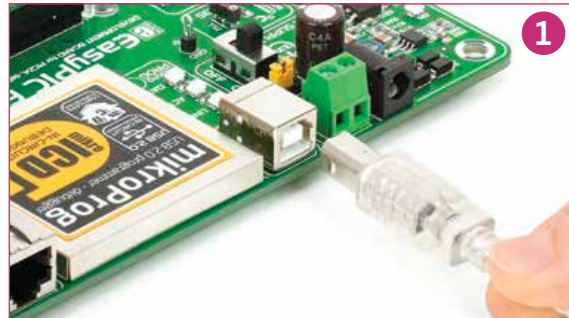

### 2. Using adapter



Set J9 jumper to EXT position

To power the board via adapter connector, place jumper J9 in EXT position. You can then plug in the adapter cable as shown on images 3 and 4, and turn the power switch ON.

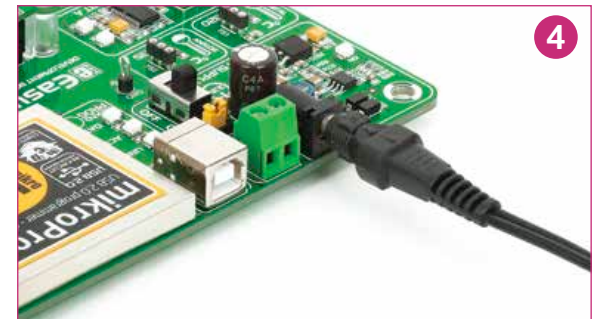
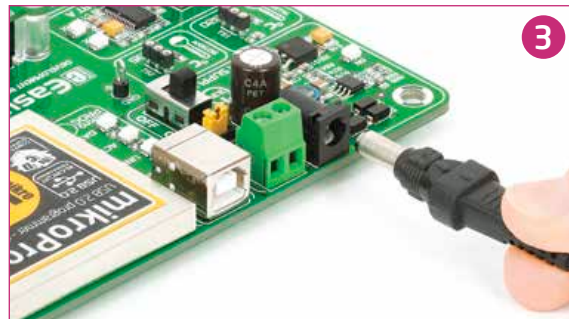

### 3. With laboratory power supply



Set J9 jumper to EXT position

To power the board using screw terminals, place jumper J9 in EXT position. You can then screw-on the cables in the screw terminals as shown on images 5 and 6, and turn the power switch ON.

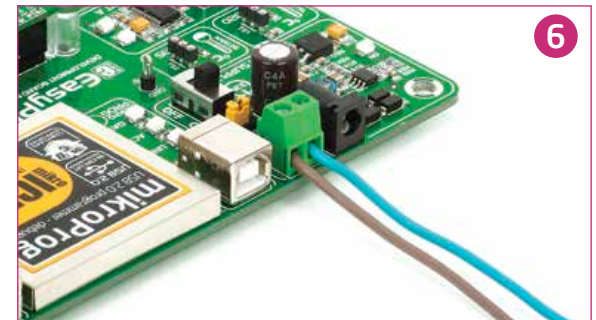
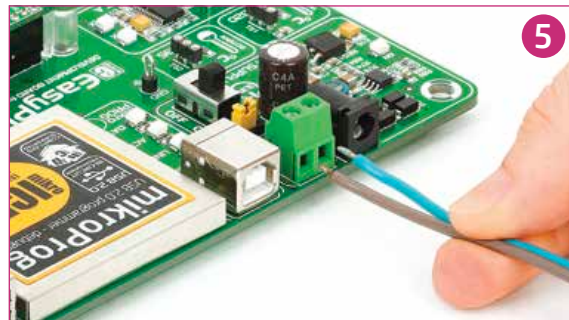



# MCU cards

Microcontrollers are supported using specialized MCU cards containing 104 pins, which are placed into the on-board female MCU socket. There are several types of cards which cover PIC24x, dsPIC33x, PIC32MX4xx, PIC32MX7xx microcontroller families in 100-pin TQFP packages. One of the **MCU cards** is shown on **Figure 4-1**.

It contains **PIC32MX795F512L** microcontroller with on-chip peripherals and is a great choice for both beginners and professionals. After testing and building the final program, this card can also be taken out of the board socket and used in your final device.

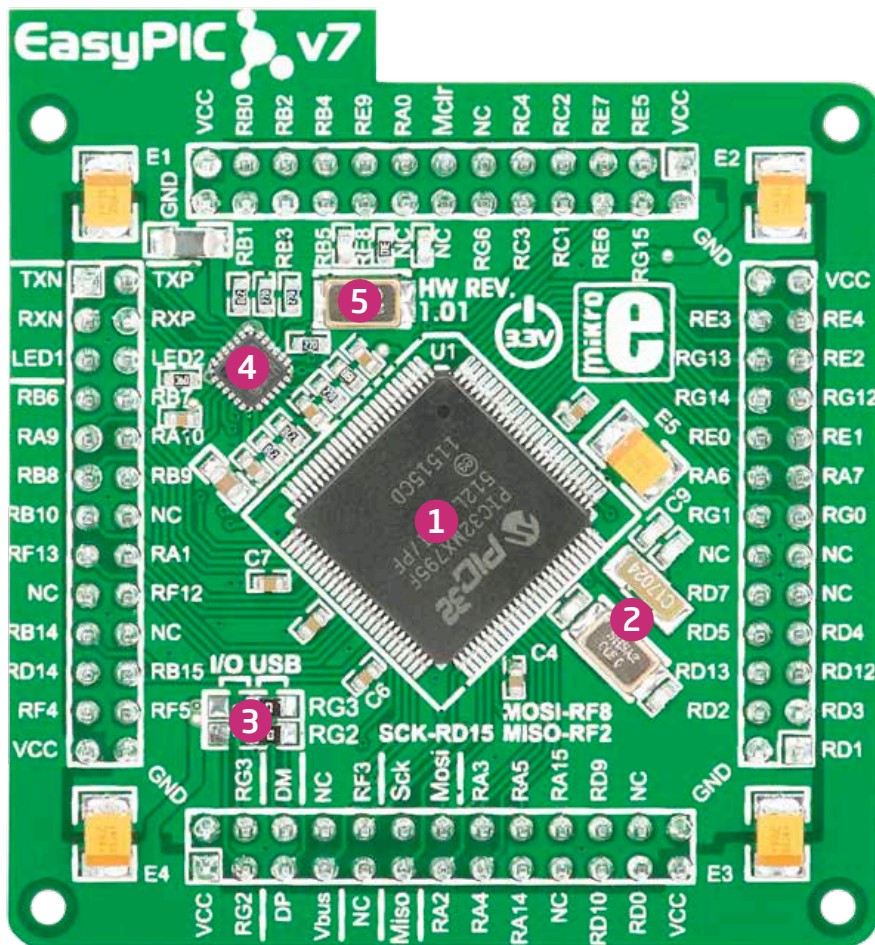

Figure 4-1: MCU card with PIC32MX795F512L

- 1 **PIC32MX795F512L** has **80MHz** maximum frequency, **512K bytes** of program memory (flash), **128K bytes** of data memory. It has integrated **Ethernet controller**, **USB** (OTG, Host, Device), **85 General purpose I/O pins**, **5 16-bit timers**, **16 Analog Input pins (ADC)**, **6 UARTs**, internal **8 MHz** and **32kHz** oscillators, internal **Real time clock (RTC)**, **5 I2C**, **4 SPI** and **2 CAN** controllers. It also contains **3 analog comparators** and two programming and debugging interfaces.
- 2 **8MHz crystal oscillator**. We carefully chose the most convenient crystal value that provides clock frequency which can be used directly, or with the PLL multipliers to create higher MCU clock value. MCU card also contains **32.768 kHz** crystal oscillator which provides external clock waveform for RTCC module.
- 3 **USB communications lines**. These two jumpers, when in USB position, connect D+ and D- lines of the on-board USB connector with RG2 and RG3 microcontroller pins. Since **PIC32MX795F512L** supports USB, jumpers are in USB position.
- 4 **Ethernet transceiver**. This MCU card contains single-chip Ethernet physical (PHY) layer transceiver which provides additional Ethernet functionality to **PIC32MX795F512L** controller
- 5 **25MHz crystal oscillator**. This crystal oscillator is connected to external Ethernet module.





## How to properly place your MCU card into the socket?

Before you plug the microcontroller card into the socket, make sure that the **power supply is turned off**. Images below show how to correctly plug the MCU card. First make sure that MCU card orientation matches the silkscreen outline on the

EasyPIC Fusion™ v7 board MCU socket. Place the MCU card over the socket so each male header is properly aligned with the female socket as shown in **Figure 4-4**. Then put the MCU card slowly down until all the pins match the socket. Check again if

everything is placed correctly and press the MCU card until it is completely plugged into the socket as shown in **Figure 4-5**. If done correctly all pins should be fully inserted. Only now you can turn on the power supply.

1

**Figure 4-3: On-board MCU socket has silkscreen markings which will help you to correctly orient the MCU card before inserting.**

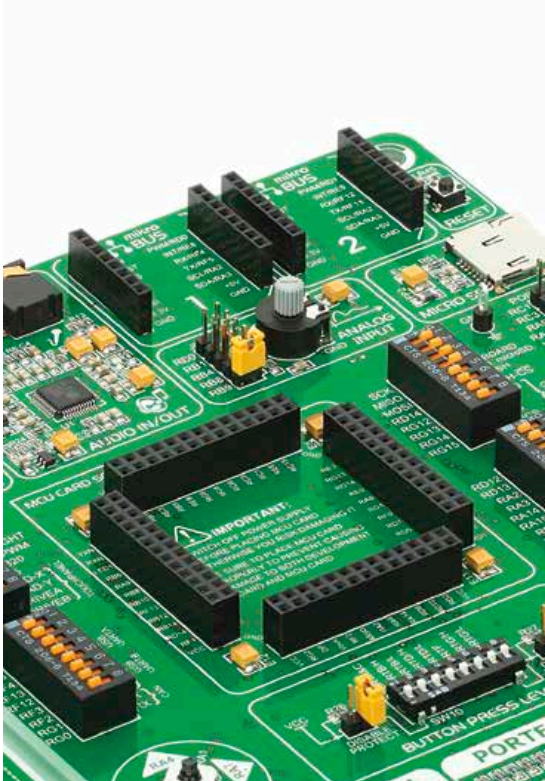

2

**Figure 4-4: Place the MCU card on the socket so that pins are aligned correctly.**

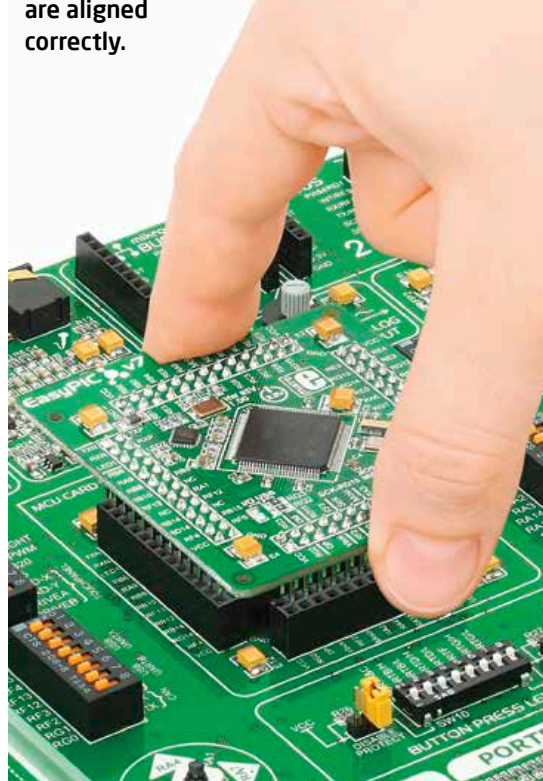

3

**Figure 4-5 Properly placed MCU card.**

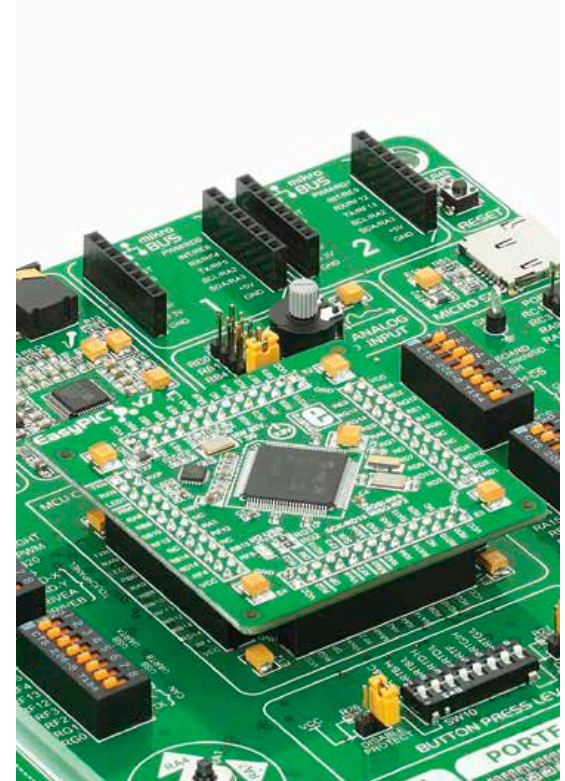



# Other supported MCU cards

MikroElektronika currently offers total of five populated MCU cards with different microcontrollers. You can also purchase empty PCB cards that you can populate on your own and solder any supported microcontroller you need in your development. There are total of five empty PCB cards available. This way your EasyPIC Fusion™ v7 board becomes truly flexible and reliable tool for almost any of your PIC24®, dsPIC33® and PIC32® projects. MCU cards can also be used in your final devices. For complete list of currently available MCU cards, please visit the board webpage:

[www.mikroe.com/easypic-fusion/](http://www.mikroe.com/easypic-fusion/)

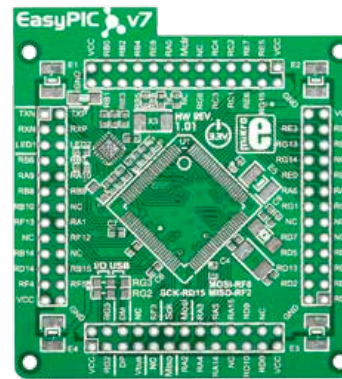

Empty 100-pin TQFP PT  
ETHERNET MCU CARD

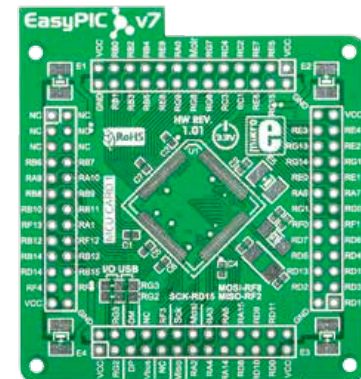

Empty 100-pin TQFP PT MCU  
CARD 1

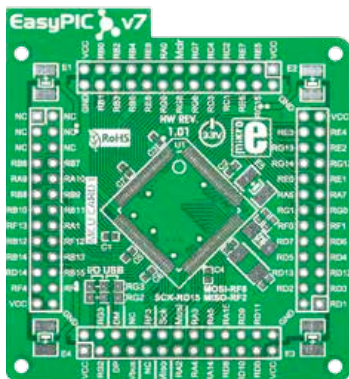

Empty 100-pin TQFP PF MCU  
CARD 1

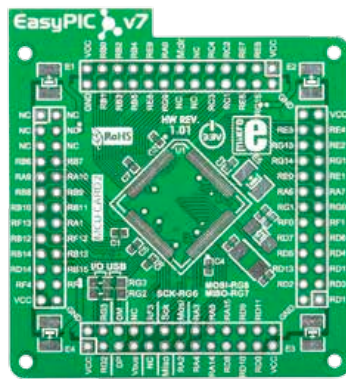

Empty 100-pin TQFP PT MCU  
CARD 2

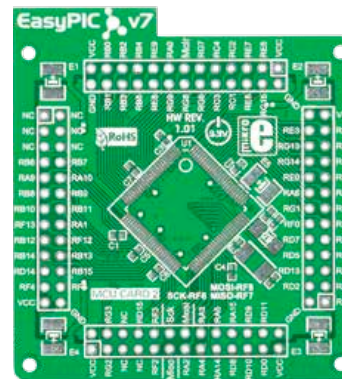

Empty 100-pin TQFP PF MCU  
CARD 2

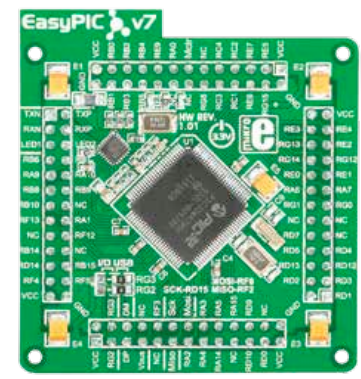

100-pin TQFP PT ETHERNET  
CARD with PIC32MX795F512L

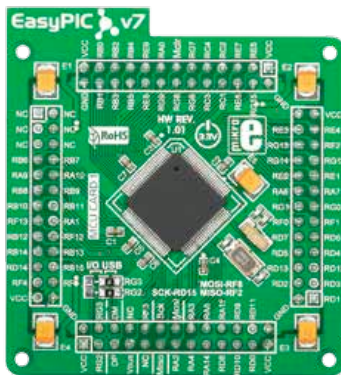

100-pin TQFP PT MCU CARD 1  
with PIC24EP512GU810

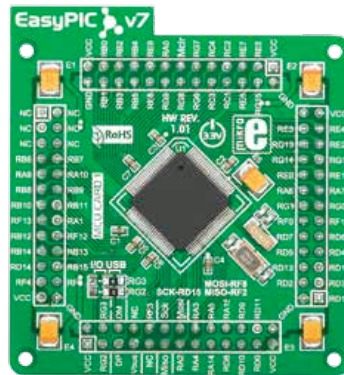

100-pin TQFP PT MCU CARD 1  
with dsPIC33EP512MU810

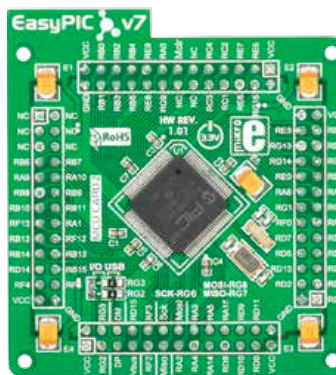

100-pin TQFP PT MCU CARD 2  
with PIC32MX460F512L

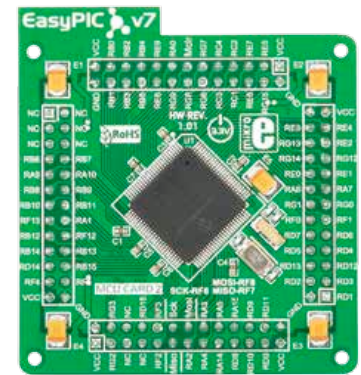

100-pin TQFP PF MCU CARD 2  
with dsPIC33FJ256GP710A



# On-board programmer

## What is mikroProg™?

mikroProg™ is a fast USB 2.0 programmer with mikroICD™ hardware In-Circuit Debugger. Smart engineering allows mikroProg™ to support all PIC10, PIC12, PIC16, PIC18, PIC24, dsPIC30/33, PIC32 MCU families in a single programmer! It supports over 570 microcontrollers from Microchip®. Outstanding performance and easy operation are among its top features.

## How do I start?

In order to start using mikroProg™ and program your microcontroller, you just have to follow two simple steps:

### 1. Install the necessary software

- Install USB drivers (**Page 14**)
- Install mikroProg Suite™ for PIC® software (**Page 15**)

### 2. Power up the board, and you are ready to go.

- Plug in the programmer USB cable
- Turn on Power switch
- LINK and POWER LED should light up.



Figure 5-1: mikroProg™ is well protected under metal casing

## Why so many LEDs?

Three LEDs indicate specific programmer operation, **Figure 5-1**. **Link** LED lights up when USB link is established with your PC, **Active** LED lights up when programmer is active. **Data** LED lights up when data is being transferred between the programmer and PC software (compiler or mikroProg Suite™ for PIC®).

## Programming with ICD2/ICD3

EasyPIC Fusion™ v7 is equipped with RJ-12 connector compatible with Microchip® ICD2® and ICD3® external programmers. You can either use the on-board mikroProg™ programmer or external programming tools as long as you use only one of them at the same time. Insert your ICD programmer cable into connector **CN33**, as shown in images **1** and **2**.

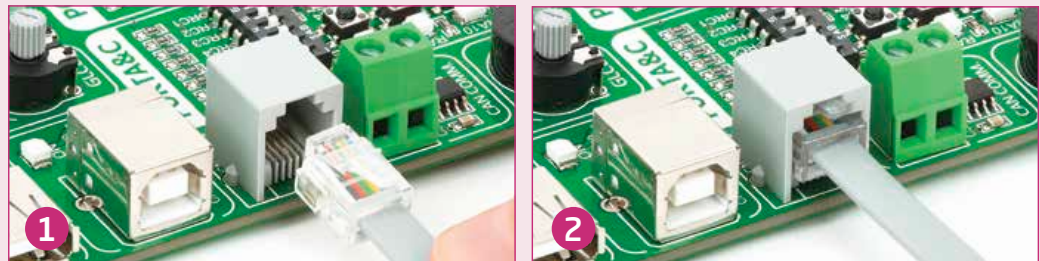

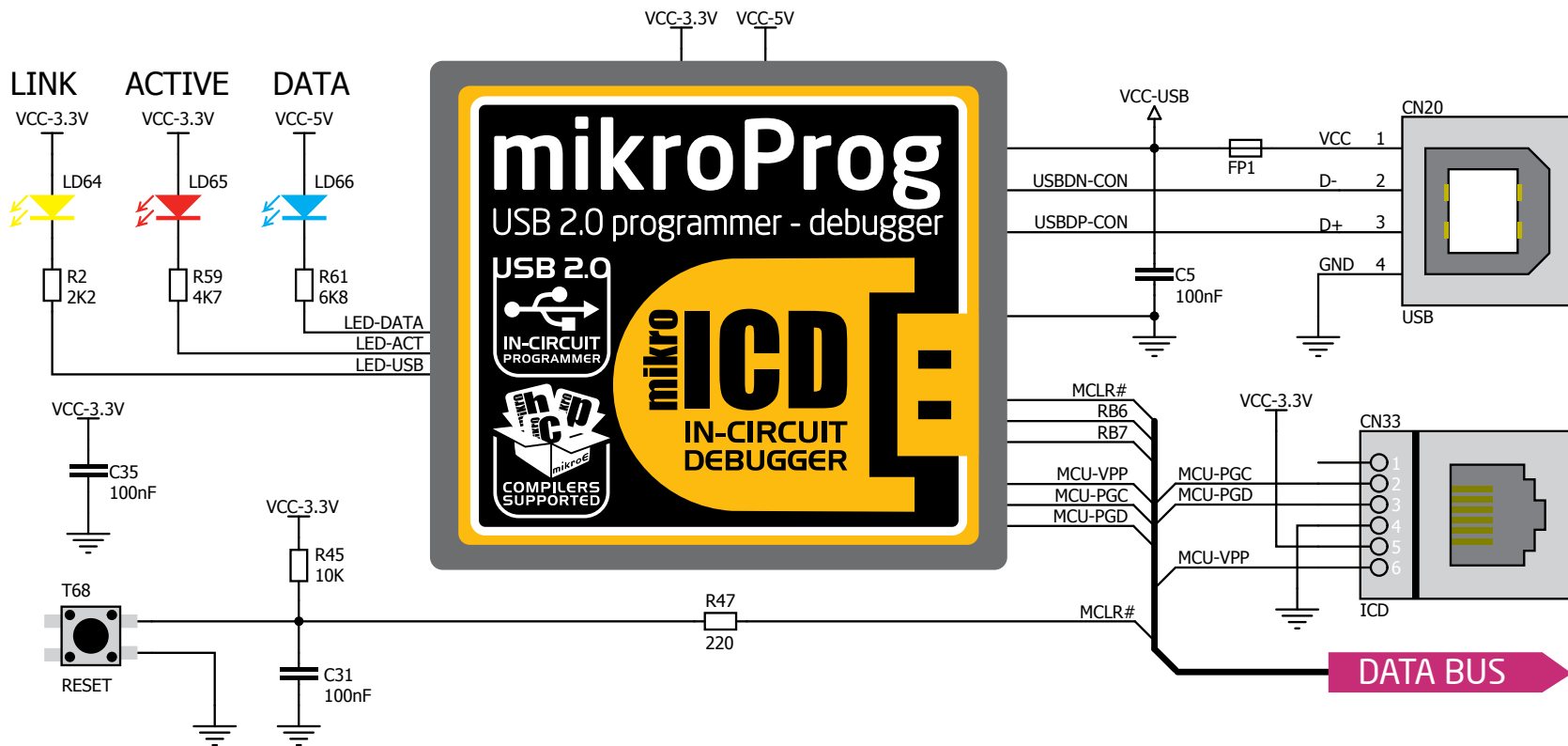

Figure 5-2: mikroProg™ block schematic

# Installing programmer drivers

On-board mikroProg™ requires drivers in order to work. Drivers can be found on the link below:



[www.mikroe.com/eng/downloads/get/1202/mikroprog\\_for\\_pic\\_drivers\\_v200.zip](http://www.mikroe.com/eng/downloads/get/1202/mikroprog_for_pic_drivers_v200.zip)

When you locate the drivers, please extract files from the ZIP archive. Folder with extracted files contains sub folders with drivers for different operating systems. Depending on which operating system you use, choose adequate folder and open it.

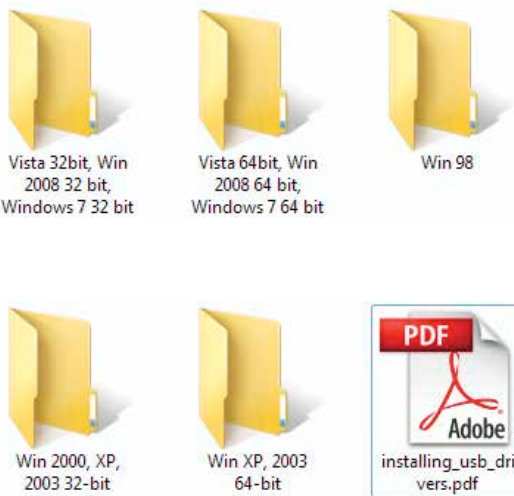

In the opened folder you should be able to locate the driver setup file. Double click on setup file to begin installation of the programmer drivers.

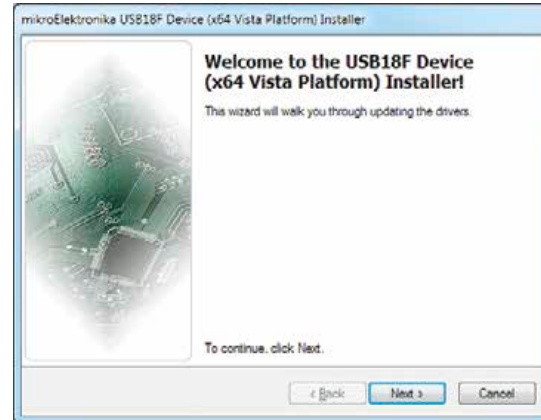

## Step 1 - Start Installation

Welcome screen of the installation. Just click on **Next** button to proceed.

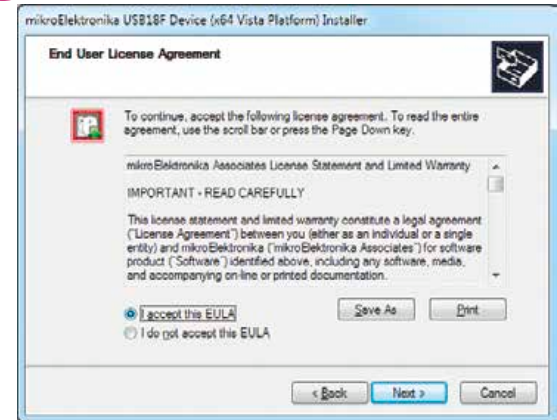

## Step 2 - Accept EULA

Carefully read **End User License Agreement**. If you agree with it, click **Next** to proceed.

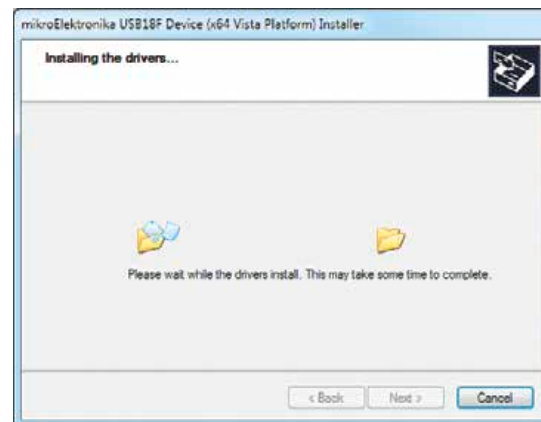

## Step 3 - Installing drivers

Drivers are installed automatically in a matter of seconds.

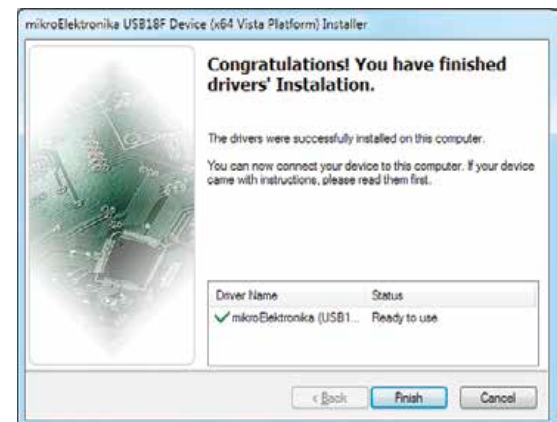

## Step 4 - Finish installation

You will be informed if the drivers are installed correctly. Click on **Finish** button to end installation process.



# Programming software

## mikroProg Suite™ for PIC®

On-board **mikroProg™** programmer requires special programming software called **mikroProg Suite™ for PIC®**. This software is used for programming all of Microchip® microcontroller families, including PIC10, PIC12, PIC16, PIC18, dsPIC30/33, PIC24 and PIC32. Software has intuitive interface and **SingleClick™** programming technology. To begin, first locate the installation archive on our website:



[http://www.mikroe.com/downloads/get/1201/mikroprog\\_suite\\_for\\_pic.zip](http://www.mikroe.com/downloads/get/1201/mikroprog_suite_for_pic.zip)

After downloading, extract the package and double click the executable setup file, to start installation.

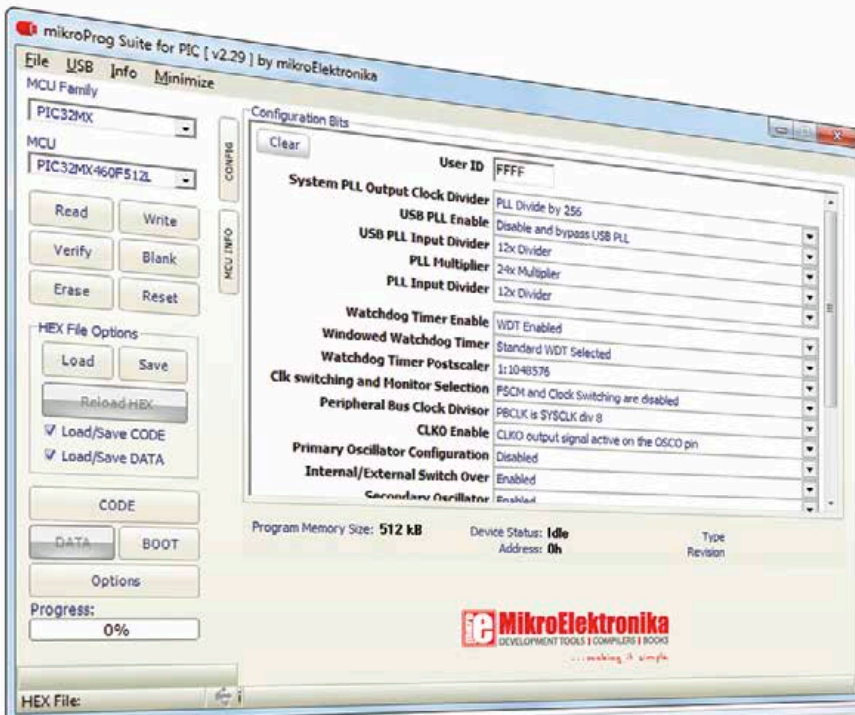

## Installation wizard - 6 simple steps



Step 1 - Start Installation



Step 2 - Accept EULA and continue



Step 3 - Install for All users or current user

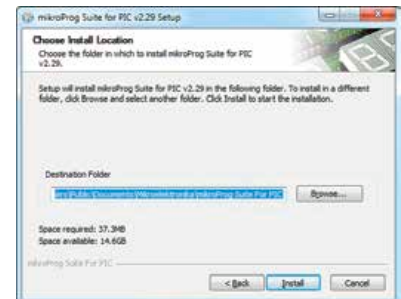

Step 4 - Choose destination folder

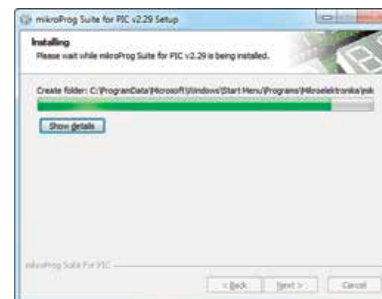

Step 5 - Installation in progress



Step 6 - Finish Installation

# mikroICD™ - In Circuit Debugger

## What is Debugging?

Every developer comes to a point where he has to monitor the code execution in order to find errors in the code, or simply to see if everything is going as planned. This hunt for bugs or errors in the code is called **debugging**. There are two ways to do this: one is **the software simulation**, which enables you to simulate what is supposed to be happening on the microcontroller as your code lines are executed and the other, most reliable one, is monitoring the code execution on the MCU itself. And this latter one is called **In-Circuit debugging**. "In-Circuit" means that it is the real deal - code executes right on the target device.

## What is mikroICD™?

The on-board **mikroProg™** programmer supports **mikroICD™** - a highly effective tool for a **Real-Time debugging** on hardware level. The mikroICD™ debugger enables you to execute your program on the host PIC microcontroller and view variable values, Special Function Registers (SFR), RAM, CODE and EEPROM memory along with the mikroICD™ code execution on hardware. Whether you are a beginner, or a professional, this powerful tool, with intuitive interface and convenient set of commands will enable you to track down bugs quickly. mikroICD™ is one of the fastest, and most reliable debugging tools on the market.

## Supported Compilers

All MikroElektronika compilers, **mikroC**, **mikroBasic** and **mikroPascal** for PIC®, dsPIC® and PIC32® natively support mikroICD™. Specialized mikroICD DLL module allows compilers to exploit the full potential of fast hardware debugging. Along with compilers, make sure to install the appropriate **programmer drivers** and **mikroProg Suite for PIC®** programming software, as described on **pages 14 and 15**.

## How do I use the debugger?

When you build your project for debugging, and program the microcontroller with this HEX file, you can start the debugger using **[F9]** command. Compiler will change layout to debugging view, and a blue line will mark where code execution is currently paused. Use **debugging toolbar** in the **Watch Window** to guide the program execution, and stop anytime. Add the desired variables to Watch and monitor their values. Complete guide to using mikroICD™ with your compiler is provided within the EasyPIC Fusion™ v7 package.



Figure 5-3: mikroICD™ manual explains debugging thoroughly

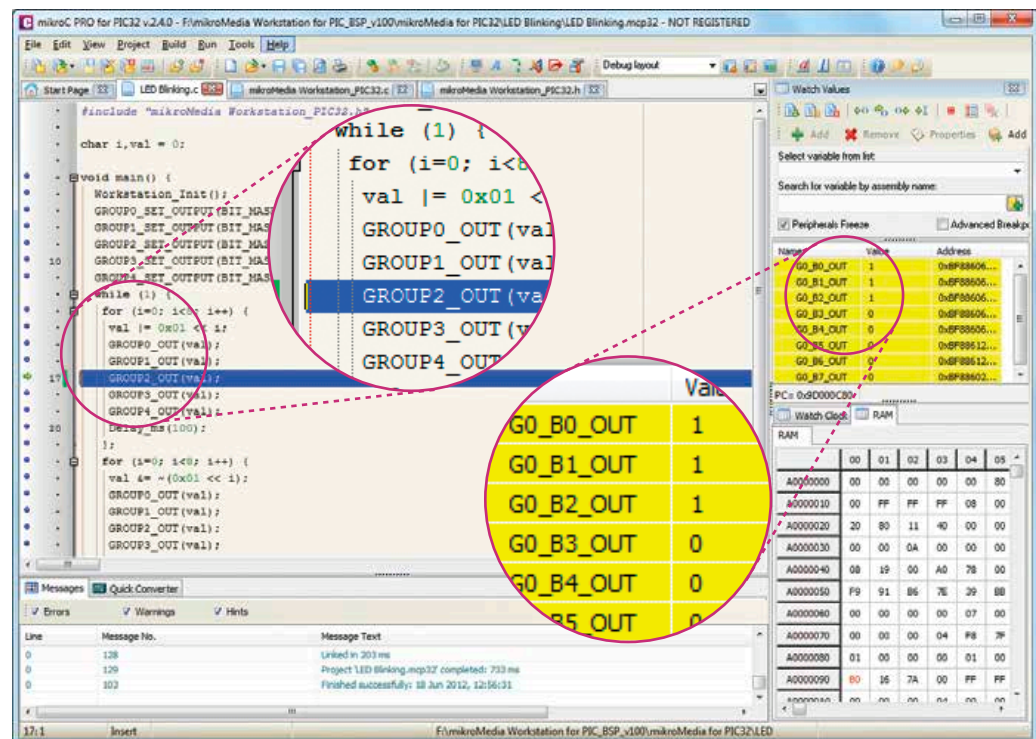













Figure 5-4: mikroC PRO for PIC32® compiler in debugging view, with SFR registers in Watch Window



# mikroCD™ commands



Here is a short overview of which debugging commands are supported in MikroElektronika compilers. You can see what each command does, and what are their shortcuts when you are in debugging mode. It will give you some general picture of what your debugger can do.

Toolbar Icon	Command Name	Shortcut	Description
	Start Debugger	<b>[F9]</b>	Starts Debugger.
	Run/Pause Debugger	<b>[F6]</b>	Run/Pause Debugger.
	Stop Debugger	<b>[Ctrl + F2]</b>	Stops Debugger.
	Step Into	<b>[F7]</b>	Executes the current program line, then halts. If the executed program line calls another routine, the debugger steps into the routine and halts after executing the first instruction within it.
	Step Over	<b>[F8]</b>	Executes the current program line, then halts. If the executed program line calls another routine, the debugger will not step into it. The whole routine will be executed and the debugger halts at the first instruction following the call.
	Step Out	<b>[Ctrl + F8]</b>	Executes all remaining program lines within the subroutine. The debugger halts immediately upon exiting the subroutine.
	Run To Cursor	<b>[F4]</b>	Executes the program until reaching the cursor position.
	Toggle Breakpoint	<b>[F5]</b>	Toggle breakpoints option sets new breakpoints or removes those already set at the current cursor position.
	Show/Hide breakpoints	<b>[Shift+F4]</b>	Shows/Hides window with all breakpoints
	Clears breakpoints	<b>[Shift+Ctrl+F5]</b>	Delete selected breakpoints
	Jump to interrupt	<b>[F2]</b>	Opens window with available interrupts (doesn't work in mikroCD™ mode)



# Input/Output Group

One of the most distinctive features of EasyPIC Fusion™ v7 are it's Input/Output PORT groups. They add so much to the connectivity potential of the board.

## Everything is grouped together

PORT headers, PORT buttons and PORT LEDs next to each other and grouped together. It makes development easier, and the entire EasyPIC Fusion™ v7 cleaner and well organized. We have also provided an **additional PORT headers** on the right side of the board, so you can access any pin you want from that side of the board too.

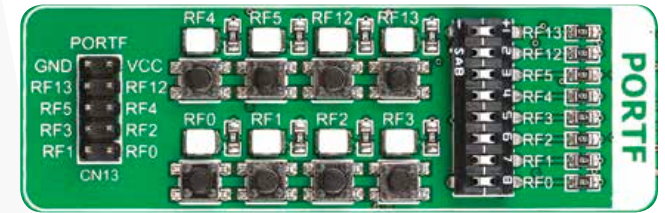

Figure 6-1: I/O group contains PORT header, tri-state pull up/down DIP switch, buttons and LEDs all in one place

## Tri-state pull-up/down DIP switches

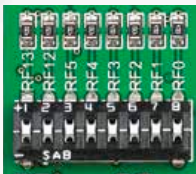
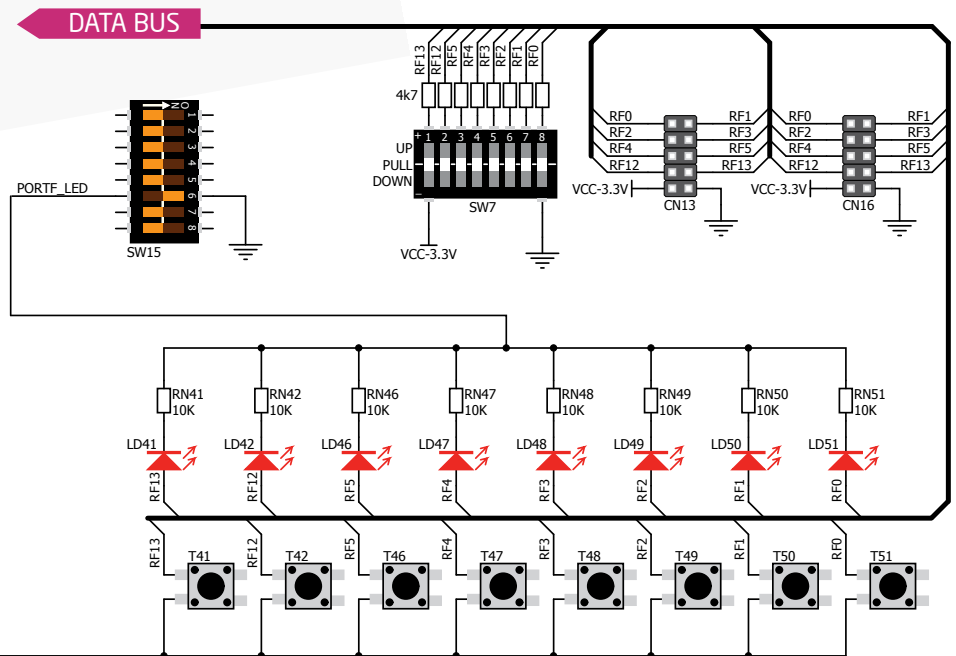

Figure 6-2: Tri-state DIP switch on PORTF

Tri-state DIP switches, like **SW7** on **Figure 6-3**, are used to enable 4K7 pull-up or pull-down resistor on any desired port pin. Each of these switches has three states:

1. **middle position** disables both pull-up and pull-down feature from the PORT pin
2. **up position** connects the resistor in pull-up state to the selected pin
3. **down position** connects the resistor in pull-down state to the selected PORT pin.



Button press level tri-state DIP switch is used to determine which logic level will be applied to port pins when buttons are pressed

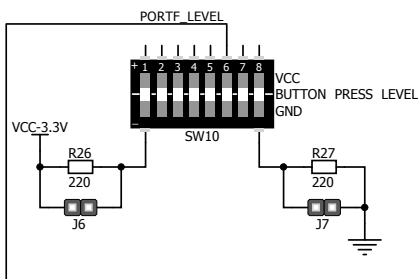
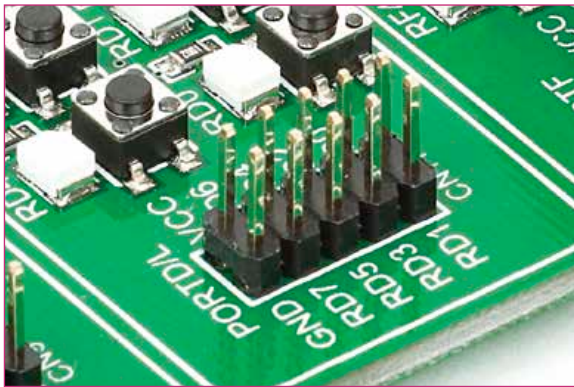
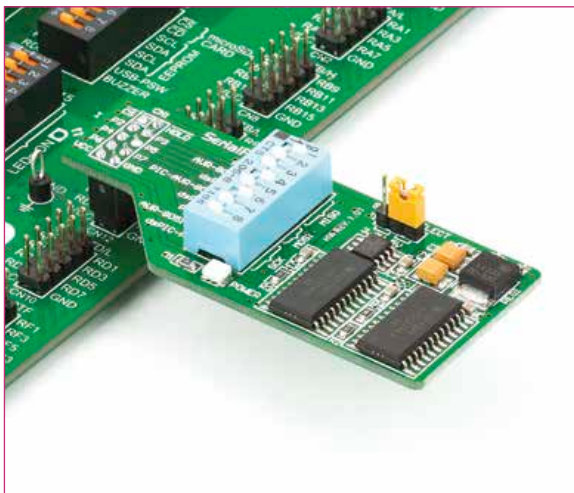

Figure 6-3: Schematic of the single I/O group connected to microcontroller PORTF



# Headers

With enhanced connectivity as one of the key features of EasyPIC Fusion™ v7, we have provided **two connection headers for each PORT**. I/O PORT group contains one male IDC10 header (like **CN13** **Figure 6-3**). There is **one more IDC10 header** available on the right side of the board, next to DIP switches (like **CN16** on **Figure 6-3**). These headers can be used to connect accessory boards with IDC10 female sockets.



**Figure 6-4:** IDC10 male headers enable easy connection with MikroElektronika accessory boards

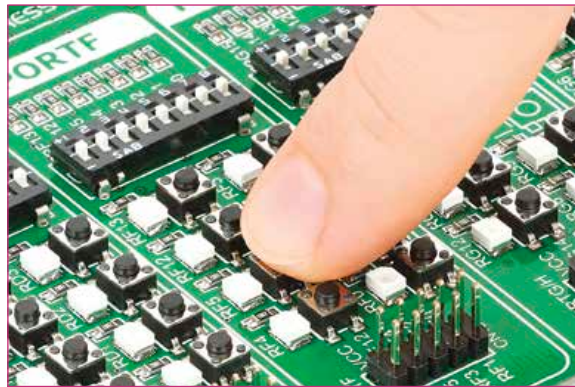

# Buttons

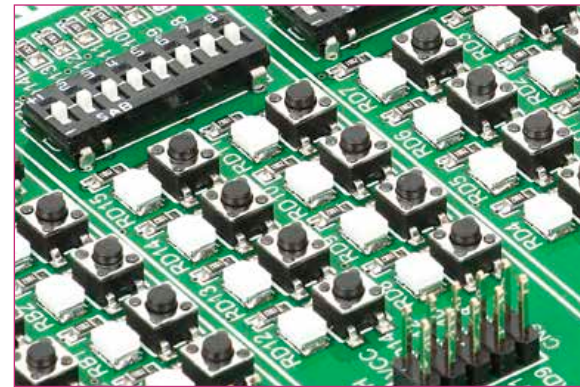

**Figure 6-5:** Button press level DIP switch (tri-state)

The logic state of all microcontroller digital inputs may be changed using **push buttons**. Tri-state DIP switch **SW10** is available for selecting which logic state will be applied to corresponding MCU pin when button is pressed, for each I/O port separately. If you, for example, place **SW10.6** in **VCC** position, then pressing of any push button in PORTF I/O group will apply logic one to the appropriate microcontroller pin. The same goes for **GND**. If DIP switch is in the middle position neither of two logic states will be applied to the appropriate microcontroller pin. You can disable pin protection 220ohm resistors by placing jumpers **J6** and **J7**, which will connect your push buttons directly to VCC or GND. Be aware that doing so you may accidentally damage MCU in case of wrong usage.

## Reset Button

In the far upper right section of the board, there is a **RESET button**, which can be used to manually reset the microcontroller.



# LEDs

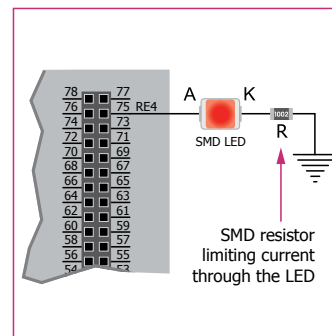

**LED (Light-Emitting Diode)** is a highly efficient electronic light source. When connecting LEDs, it is necessary to place a current limiting resistor in series so that LEDs are provided with the current value

specified by the manufacturer. The current varies from 0.2mA to 20mA, depending on the type of the LED and the manufacturer. The EasyPIC Fusion™ v7 board uses low-current LEDs with typical current consumption of 0.2mA or 0.3mA. Board contains 68 LEDs which can be used for visual indication of the logic state on PORT pins. An active LED indicates that a logic high (1) is present on the pin. In order to enable PORT LEDs, it is necessary to enable the corresponding DIP switch on **SW15** (**Figure 6-6**).

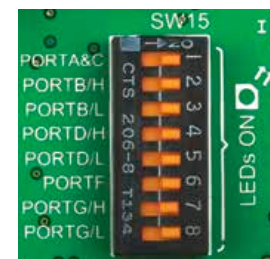

**Figure 6-6:** SW15.1 through SW15.8 switches are used to enable PORT LEDs



# mikroBUS™ sockets

Easier connectivity and simple configuration are imperative in modern electronic devices. Success of the USB standard comes from its simplicity of usage and high and reliable data transfer rates. As we in MikroElektronika see it, Plug-and-Play devices with minimum settings are the future in embedded world too. This is why our engineers have come up with a simple, but brilliant pinout with lines that most of today's accessory boards require, which almost completely eliminates the need of additional hardware settings. We called this new standard the **mikroBUS™**. EasyPIC Fusion™ v7 supports mikroBUS™ with two on-board sockets. As you can see, there are no additional DIP switches, or jumper selections. Everything is already

routed to the most appropriate pins of the microcontroller sockets.

## mikroBUS™ host connector

Each mikroBUS™ host connector consists of two 1x8 female headers containing pins that are most likely to be used in the target accessory board. There are three groups of communication pins: **SPI**, **UART** and **I<sup>2</sup>C** communication. There are also single pins for **PWM**, **Interrupt**, **Analog input**, **Reset** and **Chip Select**. Pinout contains two power groups: **+5V** and **GND** on one header and **+3.3V** and **GND** on the other 1x8 header.

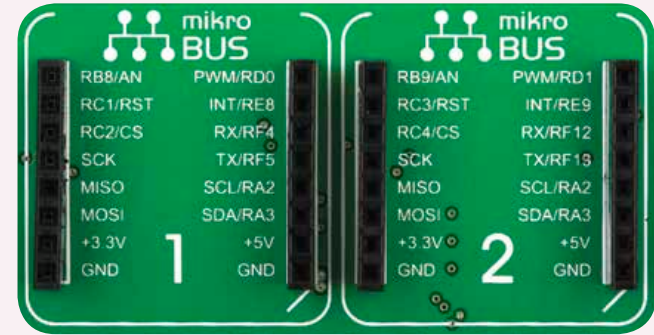

## mikroBUS™ pinout explained

<b>AN</b> - Analog pin	<b>PWM</b> - PWM output line
<b>RST</b> - Reset pin	<b>INT</b> - Hardware Interrupt line
<b>CS</b> - SPI Chip Select line	<b>RX</b> - UART Receive line
<b>SCK</b> - SPI Clock line	<b>TX</b> - UART Transmit line
<b>MISO</b> - SPI Slave Output line	<b>SCL</b> - I2C Clock line
<b>MOSI</b> - SPI Slave Input line	<b>SDA</b> - I2C Data line
<b>+3.3V</b> - VCC-3.3V power line	<b>+5V</b> - VCC-5V power line
<b>GND</b> - Reference Ground	<b>GND</b> - Reference Ground

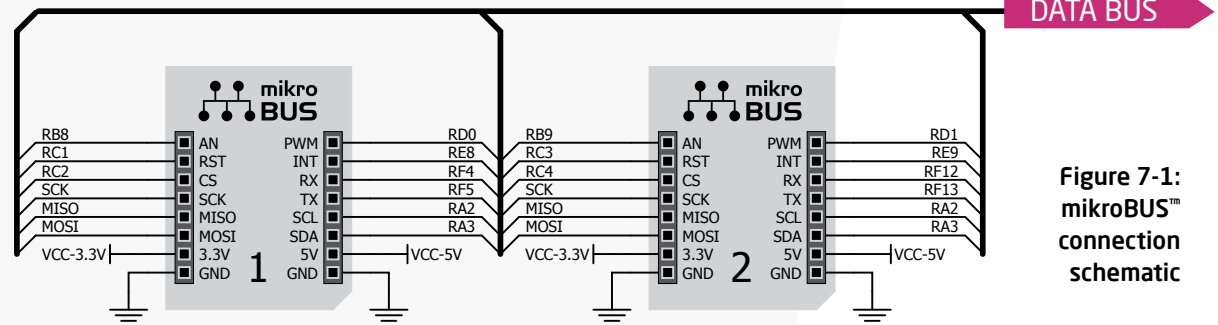
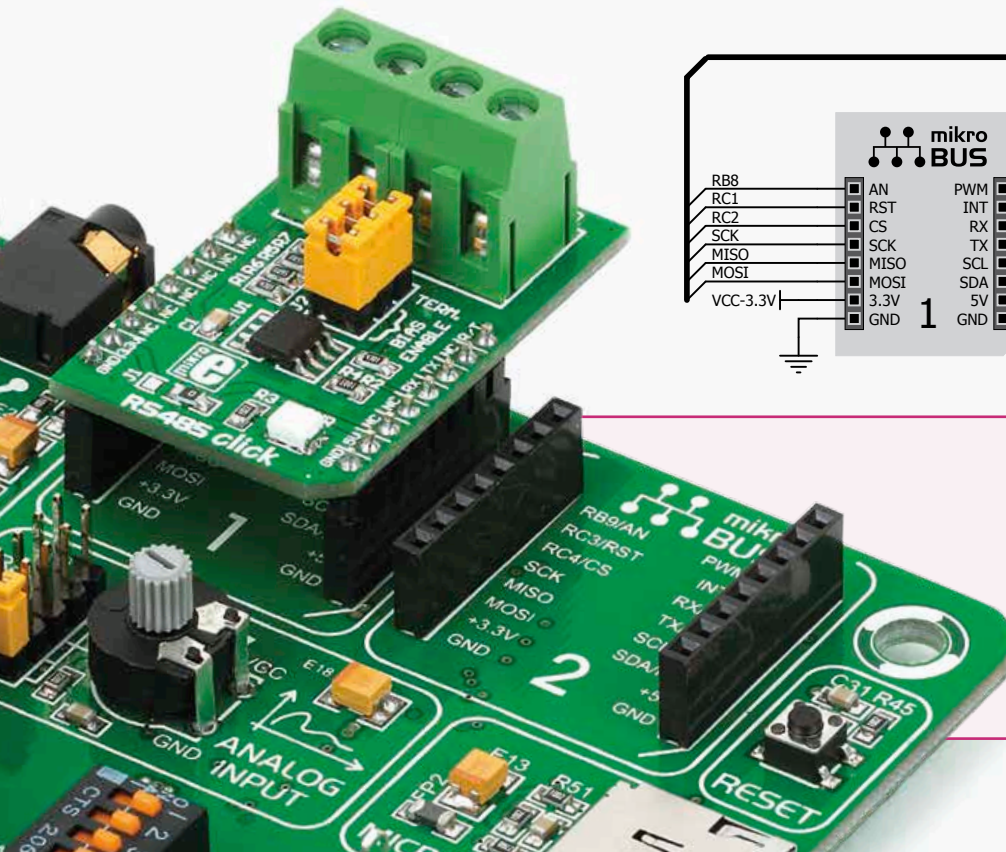

Figure 7-1:  
mikroBUS™  
connection  
schematic

## Integrate mikroBUS™ in your design

mikroBUS™ is not made to be only a part of our development boards. You can freely place mikroBUS™ host connectors in your final PCB designs, as long as you clearly mark them with mikroBUS™ logo and footprint specifications. For more information, logo artwork and PCB files visit our web site:



<http://www.mikroe.com/mikrobus/>



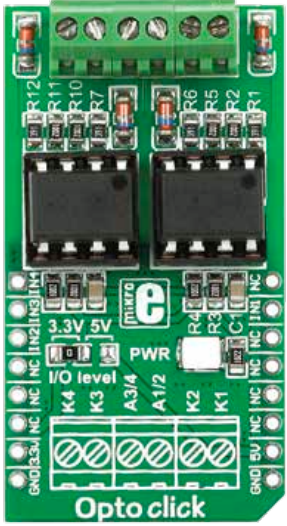

Opto click™

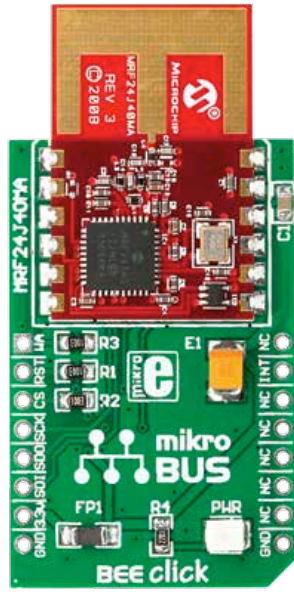

BEE click™



BlueTooth click™



WiFi PLUS click™



GPS click™

# Click Boards™ are plug-n-play!

MikroElektronika portfolio of over 200 accessory boards is now enriched by an additional set of mikroBUS™ compatible **Click Boards™**. Almost each month several new Click boards™ are released. It is our intention to provide the community with as much of these boards as possible, so you will be able to expand your EasyPIC Fusion™ v7 with additional functionality with literally

zero hardware configuration. Just plug and play. Visit the Click boards™ web page for the complete list of available boards:



<http://www.mikroe.com/click/>

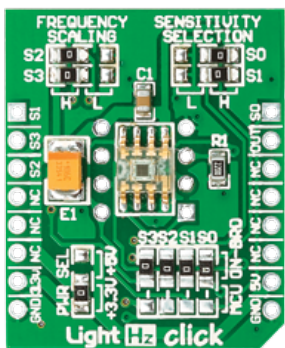

Light Hz click™

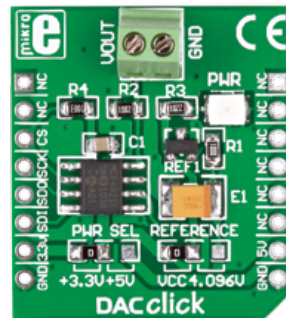

DAC click™

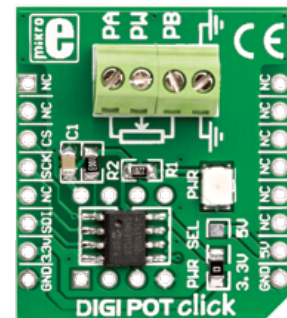

DIGIPOT click™

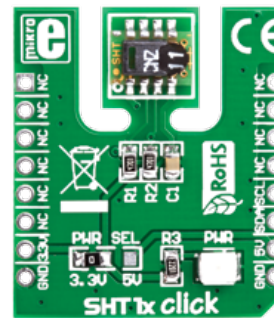

SHT1x click™



THERMO click™





# USB-UART B



## Enabling USB-UART B

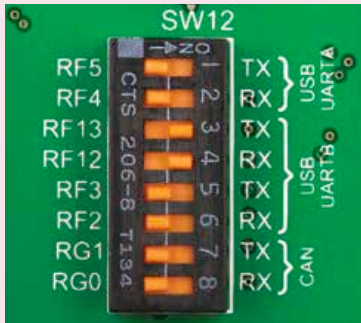

In order to enable USB-UART B communication, you must push **SW12.3** and **SW12.4** or **SW12.5** and **SW12.6** to **ON** position. This connects the **RX** and **TX** lines to appropriate microcontroller pins.

If you need to use more than one USB-UART in your application, you have another **USB-UART B** connector available on the board too. Both available USB-UART modules can operate at the same time, because they are routed to separate microcontroller pins.

USB-UART B communication is being done through a FT232RL controller, USB connector (**CN23**) and microcontroller UART module. To establish this connection, you must connect **RX** and **TX** lines of the FT232RL to the appropriate pins of the microcontroller. This selection is done using DIP switches **SW12.3** and **SW12.4** or **SW12.5** and **SW12.6**.

When using either USB-UART A or USB-UART B, make sure to disconnect all devices and additional boards that could interfere with the signals and possibly corrupt the data being sent or received.

In order to use USB-UART B module on EasyPIC Fusion™ v7, you must first install FTDI drivers on your computer. Drivers can be found on link below:



<http://www.ftdichip.com/Drivers/VCP.htm>

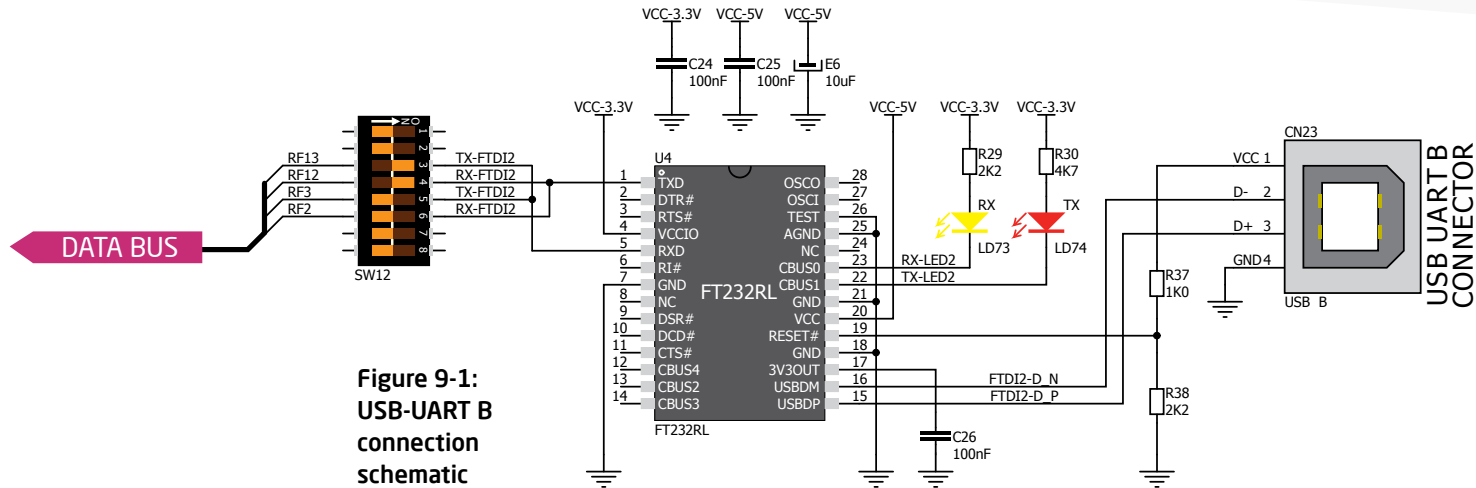

**Figure 9-1:**  
USB-UART B  
connection  
schematic



# USB HOST

USB is the acronym for **Universal Serial Bus**. This is a very popular industry standard that defines cables, connectors and protocols used for communication and power supply between computers and other devices. EasyPIC Fusion™ v7 contains USB HOST connector (**CN24**) for USB Standard Type A plug, which enables microcontrollers that support USB communication to establish a connection with the target device (eg. USB Keyboard, USB Mouse, etc). USB host also provides the necessary 5V power supply to the target via **TPS2041B** IC. Detection whether USB device is connected to HOST connector can be done through **VBUS** line. You can enable or disable USB device power supply connected to HOST via **SW14.7** switch.

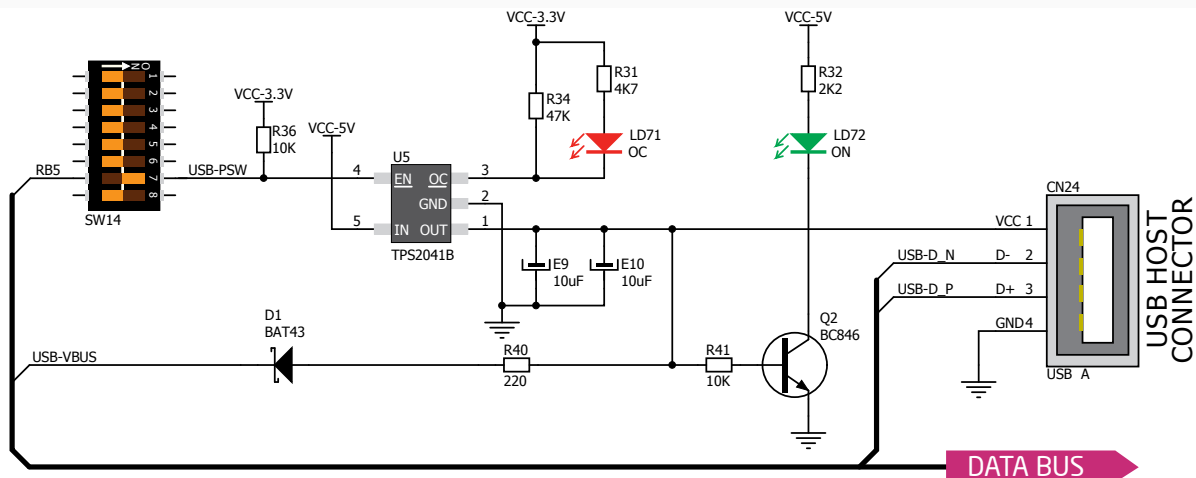
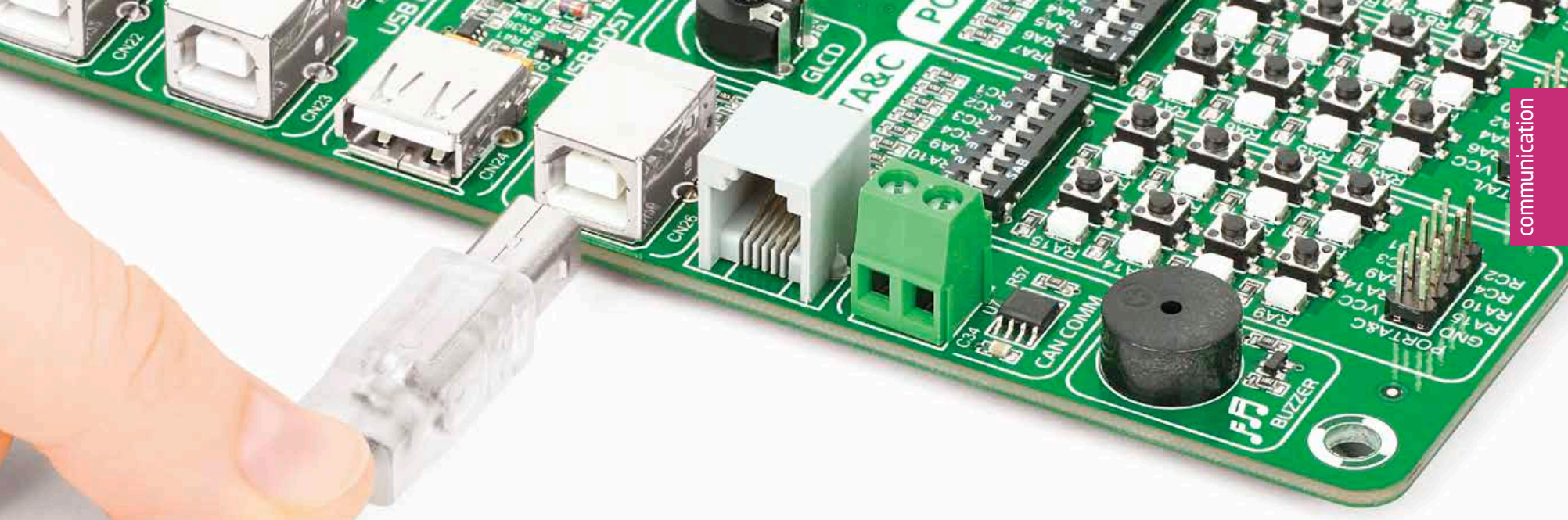

Figure 10-1: USB host connection schematic



# USB device

EasyPIC Fusion™ v7 also contains USB DEVICE connector (**CN26**) which enables microcontrollers that support USB communication to establish a connection with the target host (eg. PC, Laptop, etc.). It lets you build a slave USB device (HID, Composite, Generic, etc.). Connector supports USB Standard Type B plug. Detection whether USB device is connected to HOST can be done through **VBUS** line. This line is connected directly to microcontroller pin. When connected to HOST, dedicated amber-colored power LED will light up as well. This VCC line cannot be used for powering the board. It's only used for detecting connection.

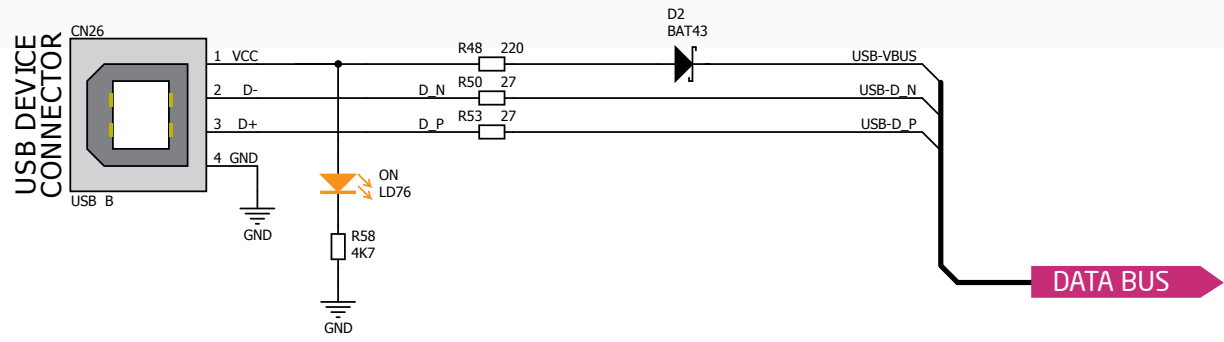

Figure 11-1: USB device connection schematic





# Ethernet communication

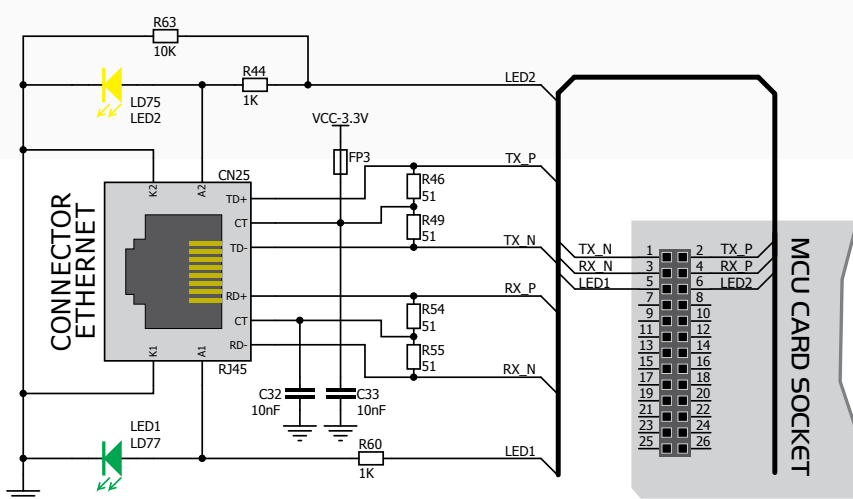
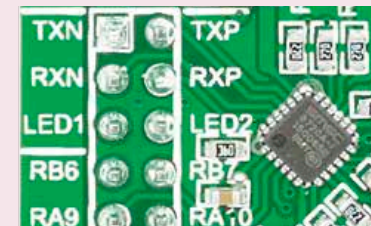

Figure 12-1: Ethernet connection schematic

Ethernet is a popular computer networking technology for local area networks (LAN). Systems communicating over Ethernet divide a stream of data into individual packets called frames. Each frame contains source and destination addresses and error-checking data so that damaged data can be detected and re-transmitted. EasyPIC Fusion™ v7 features standard **RJ-45** connector which enables microcontrollers that support Ethernet communication to establish a connection with a computer, router or other devices. All four Ethernet lines (TPOUT+, TPOUT-, TPIN+ and TPIN-) are routed directly to the MCU card socket and cannot be accessed via PORT headers. Additional signalization LEDs (green and yellow) are provided on the board next to **RJ-45** connector.



## Ethernet MCU cards



Ethernet communication (TX\_P, TX\_N, RX\_P and RX\_N) and signalization lines (LED1, LED2) are routed directly to the MCU card socket and can be used only with a Ethernet MCU card (100-pin TQFP PT ETHERNET , Page 11).





# CAN communication



## Enabling CAN

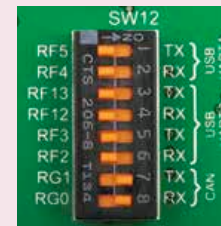

**Figure 13-2:** enabling CAN communication

In order to enable CAN communication, you must push **SW12.7** (RG1) and **SW12.8** (RG0) to **ON** position. This connects the **TX** and **RX** lines to appropriate microcontroller pins.

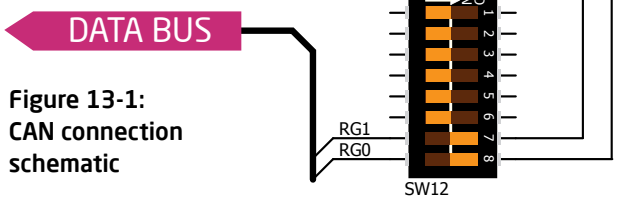
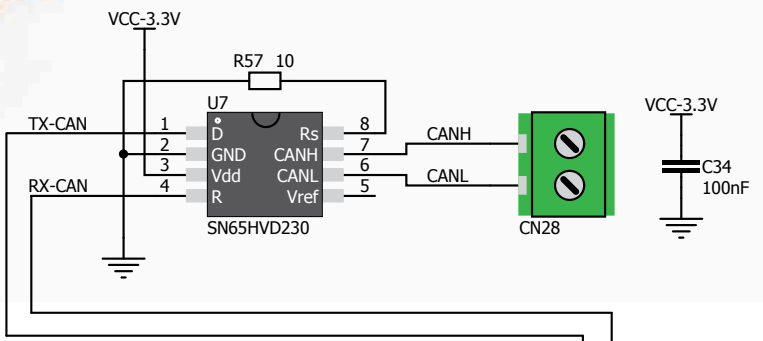

**Figure 13-1:** CAN connection schematic

Controller Area Network (CAN or CAN bus) is a vehicle bus standard designed to allow microcontrollers and devices to communicate with each other within a vehicle without a host computer. CAN is a message-based protocol, designed specifically for automotive applications but now also used in other areas such as industrial automation and medical equipment. EasyPIC Fusion™ v7 is equipped with **SN65HVD230** - a 3.3V CAN Transceiver and a pair of screw terminals which provide microcontrollers with integrated CAN controller with the necessary physical interface for CAN communication.

# Audio I/O



It's hard to imagine modern multimedia devices without high quality audio reproduction modules. Sounds and music are almost as important as graphical user interfaces. Along with other multimedia modules, EasyPIC Fusion™ v7 contains high-end stereo **VS1053** audio codec. It features Ogg Vorbis/MP3/AAC/WMA/FLAC/WAV/MIDI **audio decoder**, as well as an PCM/IMA ADPCM/Ogg Vorbis **encoder** on a single chip. Board also contains **two stereo audio connectors** for interfacing with standard 3.5mm stereo audio jacks. VS1053 receives the input bit stream through a serial input bus, which it listens to as a system slave. The input stream is decoded and passed through a digital volume control to an 18-bit oversampling, multi-bit, sigma-delta Digital to Analog Converter (DAC). The decoding is controlled via a serial control bus. In addition to the basic decoding, it is possible to add application specific features like DSP effects to the user RAM memory. You can build music players, audio recording devices, internet radio player applications, and much more.

Figure 14-1: Audio IN/OUT connection schematic

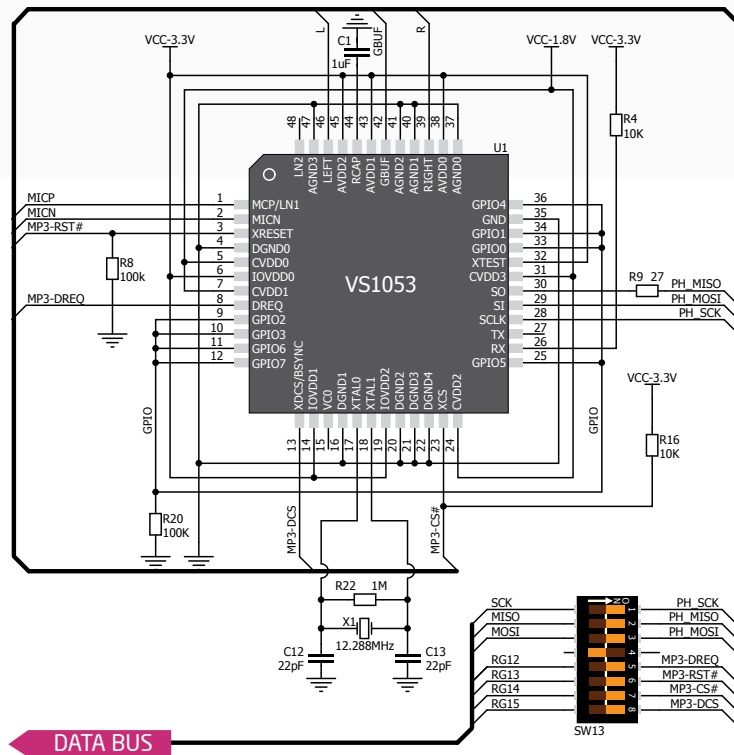

DATA BUS

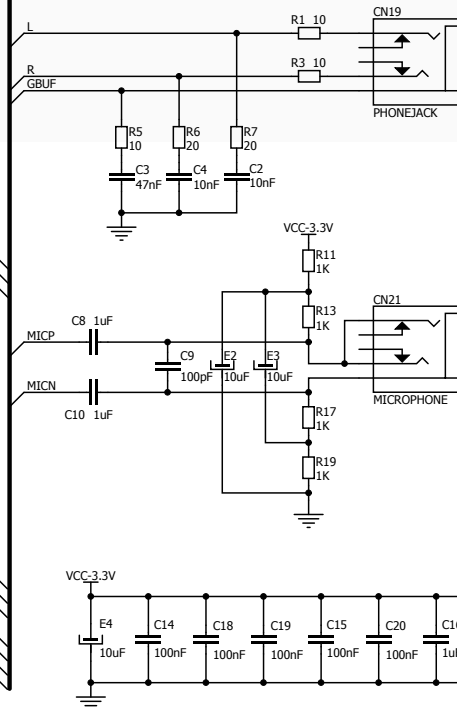

## Enabling Audio I/O



Figure 14-2: Enabling audio codec communication lines

In order to use Audio I/O module, you must connect data and Audio control lines of the microcontroller with the VS1053 audio codec. To do this, push **SW13.1-SW13.3** and **SW13.5-SW13.8** switches to **ON** position. This will connect SPI data lines with SCK, MISO and MOSI microcontroller pins, and audio control lines and chip select with RG12, RG13, RG14 and RG15 pins.



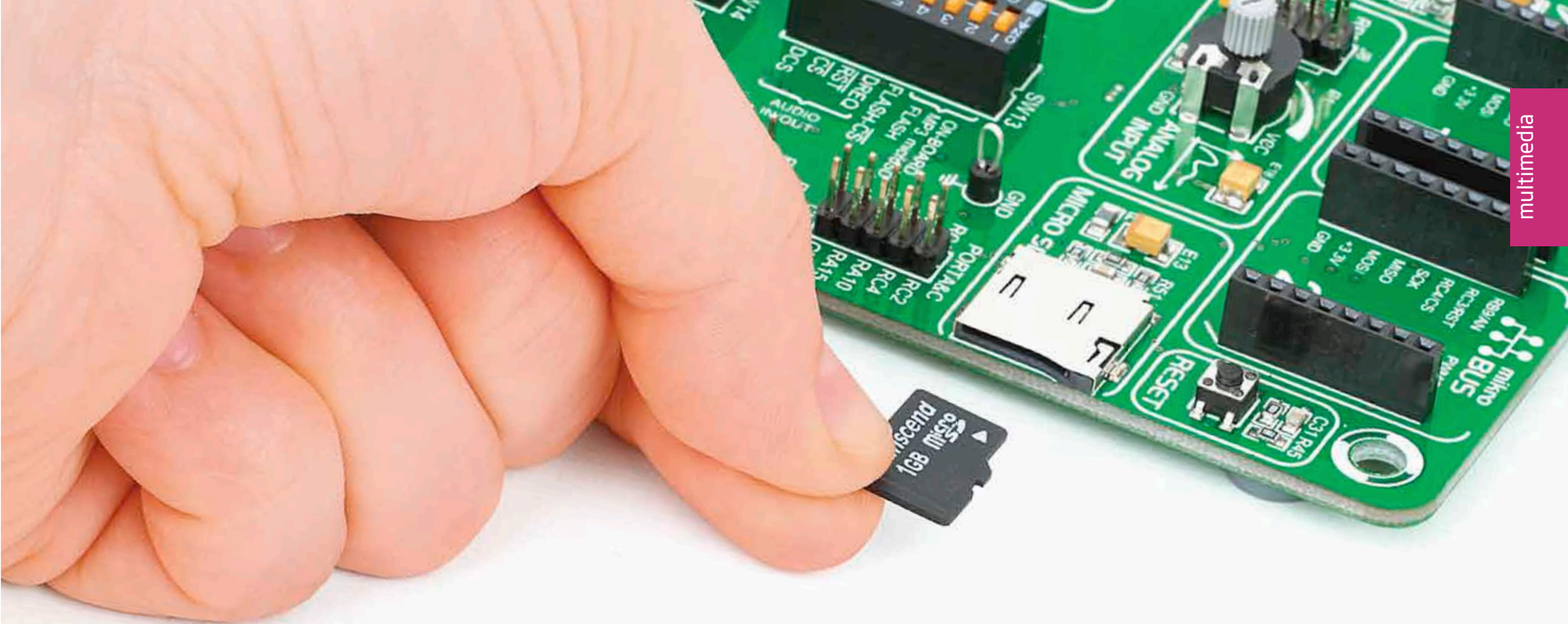

# microSD card slot

**Secure Digital (SD)** is a non-volatile memory card format developed for use in portable devices. It comes in different packages and memory capacities. It is mostly used for storing large amounts of data. EasyPIC Fusion™ v7 features the **microSD card slot**. The microSD form factor is the smallest card format currently available. It uses standard SPI user interface with minimum additional electronics, mainly used for stabilizing communication lines which can be significantly distorted at high transfer rates. Special ferrite is also provided to compensate the voltage and current glitch that can occur when pushing-in and pushing-out microSD card into the socket.



## Enabling microSD

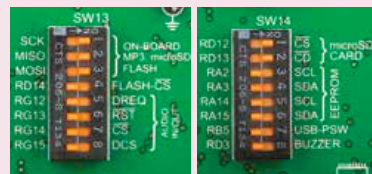

In order to access microSD card, you must enable SPI communication lines using **SW13.1 - SW13.3** DIP switches as well as Chip Select ( $\overline{CS}$ ) and Card Detect ( $\overline{CD}$ ) lines using **SW14.1** and **SW14.2** switches.

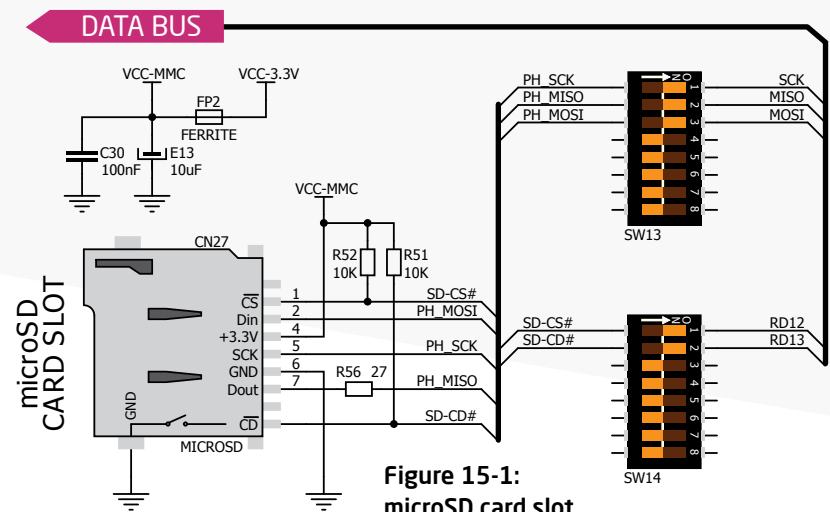

**Figure 15-1:** microSD card slot connection schematic



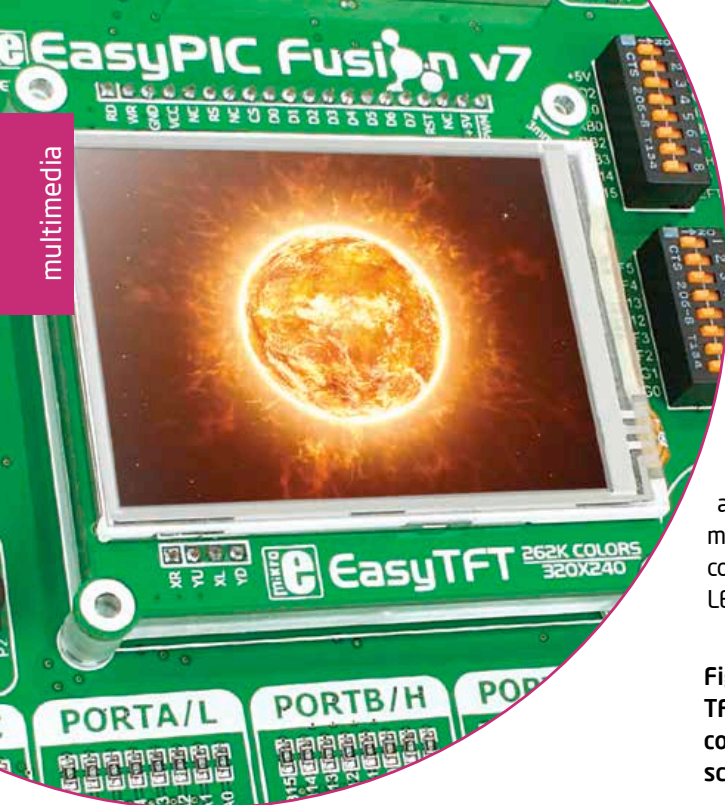

multimedia

# TFT display 320x240 pixels

One of the most powerful ways of presenting data and interacting with users is through color displays and touch panel inputs. This is a crucial element of any multimedia device. EasyPIC Fusion™ v7 features TFT color 320x240 pixel display. It is a 2.83" display with LED back-light, featuring **HX8347D** controller.

Each pixel is capable of showing 262,144 different colors. It is connected to microcontroller using standard 8080 parallel 8-bit interface, with additional control lines. Board features back-light driver which besides standard mode can also be driven with PWM signal in order to regulate brightness in range from 0 to 100%.

**Figure 16-1:**  
TFT display  
connection  
schematic

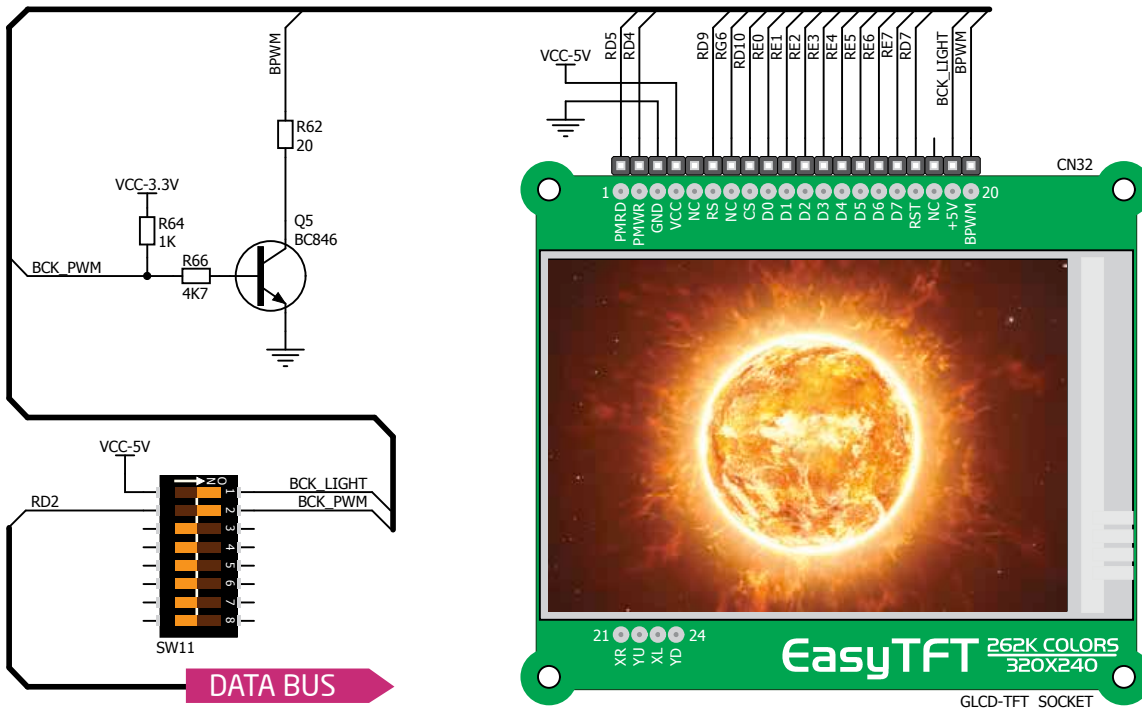

## Enabling TFT display



**Figure 16-2:**  
Turn on  
switches  
**SW11.1** and  
**SW11.2** to  
enable back-  
light and PWM  
signal from  
microcontroller.

TFT display is enabled using **SW11.1-SW11.2** DIP switches. Back-light can be enabled in two different ways:

1. It can be **turned on with full brightness** using **SW11.1** switch.
2. Brightness level can be determined **with PWM signal** from the microcontroller, allowing you to write custom back-light controlling software. This back-light mode is enabled when both **SW11.1** and **SW11.2** switches are in ON position.





# Navigation switch

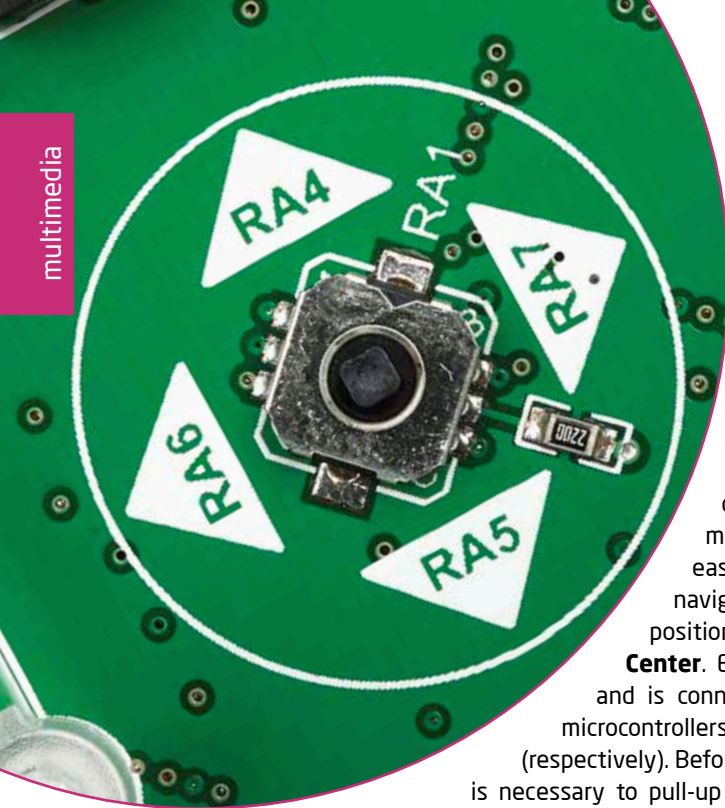

When working with multimedia applications it is far more intuitive to use a single joystick than several different push buttons that are more far apart. This is more natural for users and they can browse through on-screen menus, or even play games much easier. EasyPIC Fusion™ v7 features navigation switch with five different positions: **Up**, **Down**, **Left**, **Right** and **Center**. Each of those acts as a button, and is connected to one of the following microcontrollers pins: **RA4**, **RA5**, **RA6**, **RA7**, **RA1** (respectively). Before using the navigation switch, it is necessary to pull-up mentioned microcontroller pins using tri-state DIP switches located in I/O groups. After pressing the navigation switch in desired direction, associated microcontroller pins are connected to GND, which can be detected in user software.

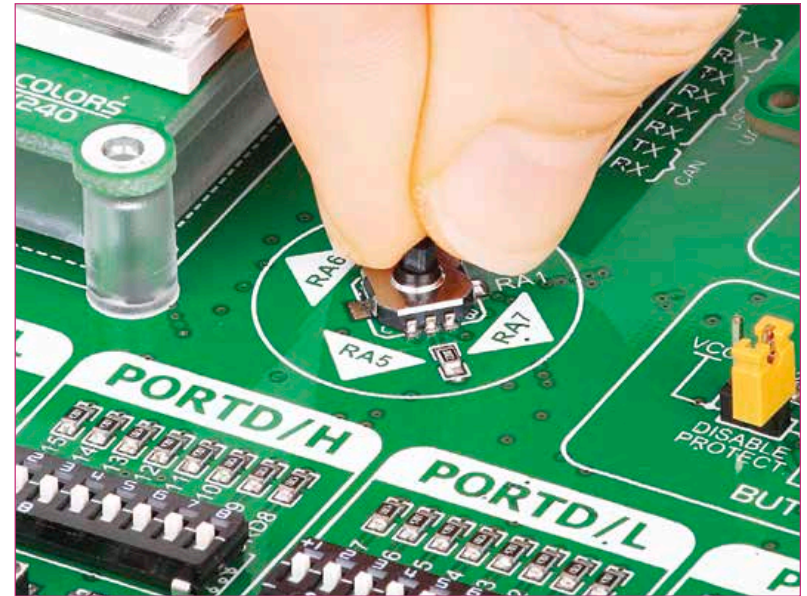

Figure 18-2: Navigation switch is an intuitive solution for browsing through on-screen menus.

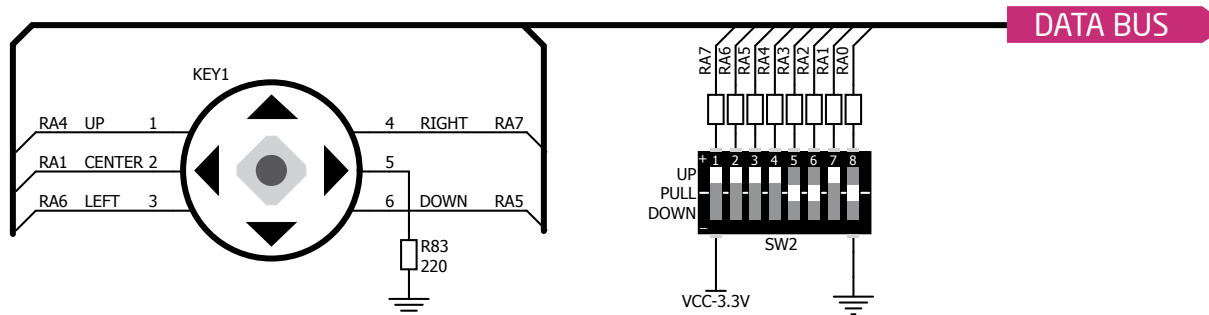

Figure 18-1: Navigation switch connection schematic. Pull-up resistors should be enabled during operation



# Piezo Buzzer

**Piezoelectricity** is the charge which accumulates in certain solid materials in response to mechanical pressure, but also providing the charge to the piezo electric material causes it to physically deform. One of the most widely used applications of piezoelectricity is the production of sound generators, called piezo buzzers. **Piezo buzzer** is an electric component that comes in different shapes and sizes, which can be used to create sound waves when provided with analog electrical signal. EasyPIC Fusion™ v7 comes with piezo buzzer which can be connected to **RD3** microcontroller pin. Connection is established using **SW14.8** DIP switch. Buzzer is driven by transistor **Q1 (Figure 19-1)**. Microcontrollers can create sound by generating a PWM (Pulse Width Modulated) signal - a **square wave** signal, which is nothing more than a sequence of logic zeros and

ones. Frequency of the square signal determines the pitch of the generated sound, and duty cycle of the signal can be used to increase or decrease the volume in the range from 0% to 100% of the duty cycle. You can generate PWM signal using hardware capture-compare module, which is usually available in most microcontrollers, or by writing a custom software which emulates the desired signal waveform.

## Supported sound frequencies

Piezo buzzer's resonant frequency (where you can expect it's best performance) is **3.8kHz**, but you can also use it to create sound in the range between **2kHz** and **4kHz**.

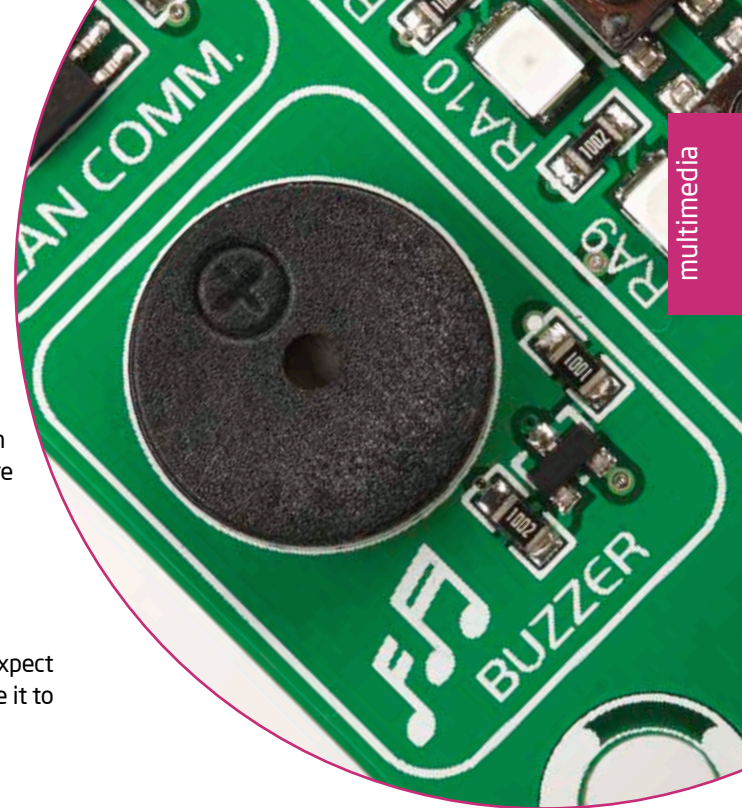

multimedia

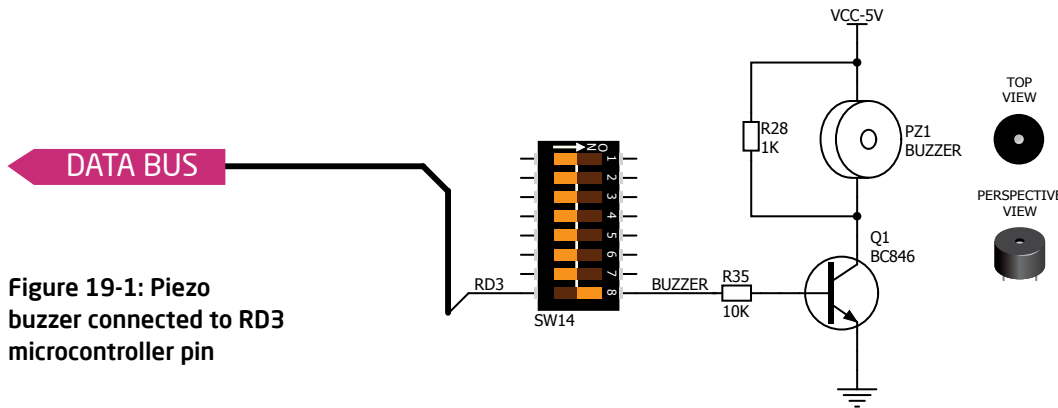

Figure 19-1: Piezo buzzer connected to RD3 microcontroller pin

## Enabling Piezo Buzzer

In order to use the on-board Piezo Buzzer in your application, you first have to connect the transistor driver of piezo buzzer to the appropriate microcontroller pin. This is done using **SW14.8** DIP switch which connects it to **RD3** pin.

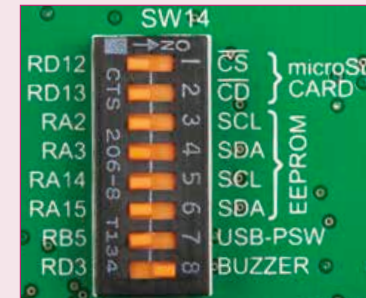

Figure 19-2: push **SW14.8** to **ON** position to connect Piezo buzzer to **RD3**

Freq = 3kHz, Duty Cycle = 50%



Freq = 3kHz, Volume = 50%

Freq = 3kHz, Duty Cycle = 80%



Freq = 3kHz, Volume = 80%

Freq = 3kHz, Duty Cycle = 20%



Freq = 3kHz, Volume = 20%

## How to make it sing?

Buzzer starts "singing" when you provide PWM signal from the microcontroller to the buzzer driver. The pitch of the sound is determined by the frequency, and amplitude is determined by the duty cycle of the PWM signal.

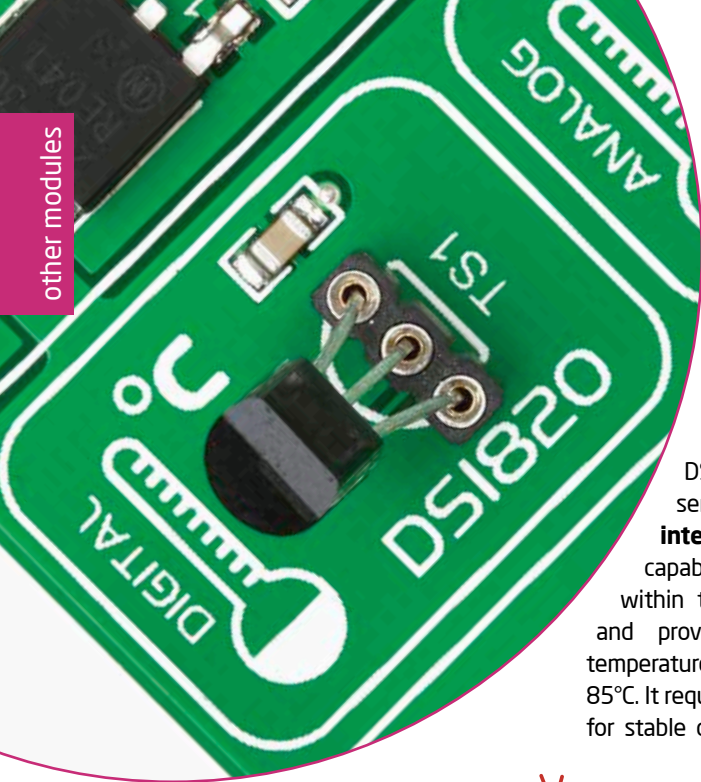

# DS1820 - Digital Temperature Sensor

DS1820 is a digital temperature sensor that uses **1-wire® interface** for its operation. It is capable of measuring temperatures within the range of -55 to 128°C, and provides  $\pm 0.5^\circ\text{C}$  accuracy for temperatures within the range of -10 to 85°C. It requires 3V to 5.5V power supply for stable operation. It takes maximum

of 750ms for the DS1820 to calculate temperature with 9-bit resolution. **1-wire® serial communication** enables data to be transferred over a single communication line, while the process itself is under the control of the master microcontroller. The advantage of such communication is that only one microcontroller pin is used. Multiple

sensors can be connected on the same line. All slave devices by default have a unique ID code, which enables the master device to easily identify all devices sharing the same interface. Board provides a separate socket (**TS1**) for the DS1820. Communication line with the microcontroller is selected using **SW11.3** DIP switch (ON position).



## Enabling DS1820 Sensor



Figure 20-1:  
DS1820 socket



Figure 20-2:  
DS1820 correctly placed in socket



Figure 20-3:  
Enabled SW11.3 DIP switch

EasyPIC Fusion™ v7 enables you to establish 1-wire® communication between **DS1820** and the microcontroller over **RA0** pin. The connection is done placing **SW11.3** DIP switch to ON position (**Figure 20-4**). When placing the sensor in the socket make sure that half-circle on the board silkscreen markings matches the rounded part of the DS1820 sensor. If you accidentally connect the sensor the other way, it may be permanently damaged. Make sure to disconnect other peripherals, LEDs and additional pull-up or pull-down resistors from the interface lines in order not to interfere with signal/data integrity.

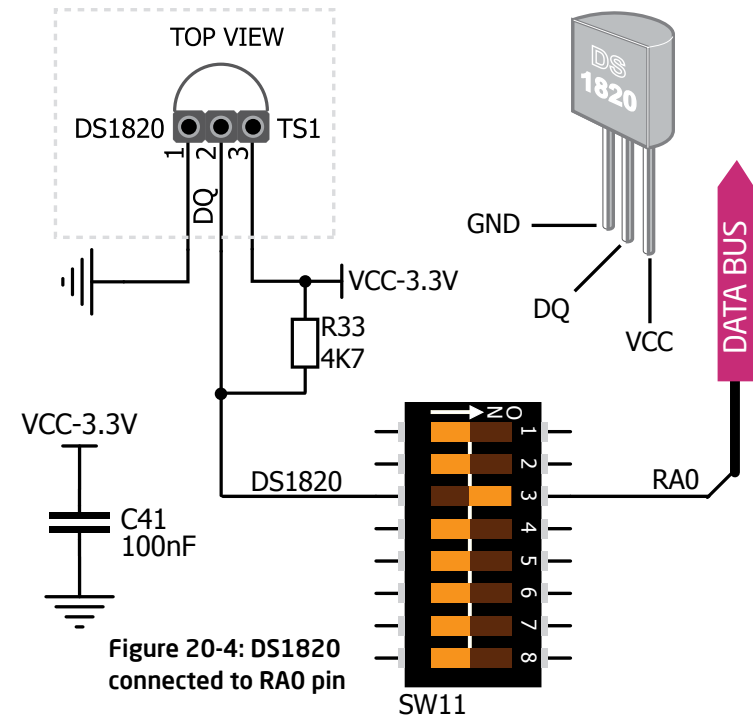

Figure 20-4: DS1820 connected to RA0 pin

# LM35 - Analog Temperature Sensor

The **LM35** is a low-cost precision integrated-circuit temperature sensor, whose output voltage is linearly proportional to the Celsius (Centigrade) temperature. The LM35 thus has an advantage over linear temperature sensors calibrated in ° Kelvin, as the user is not required to subtract a large constant voltage from its output to

obtain convenient Centigrade scaling. It has a linear  $+10.0 \text{ mV}/^\circ\text{C}$  scale factor and less than  $60 \mu\text{A}$  current drain. As it draws only  $60 \mu\text{A}$  from its supply, it has very low self-heating, less than  $0.1^\circ\text{C}$  in still air. EasyPIC Fusion™ v7 enables you to get analog readings from the LM35 sensor in restricted temperature range from  $+2^\circ\text{C}$  to

$+150^\circ\text{C}$ . Board provides a separate socket (**TS2**) for the LM35 sensor in T0-92 plastic packaging. Readings are done with microcontroller using single analog input line, which is selected with DIP switch **SW11.4**. Switch connects the sensor with **RBO** microcontroller pin.

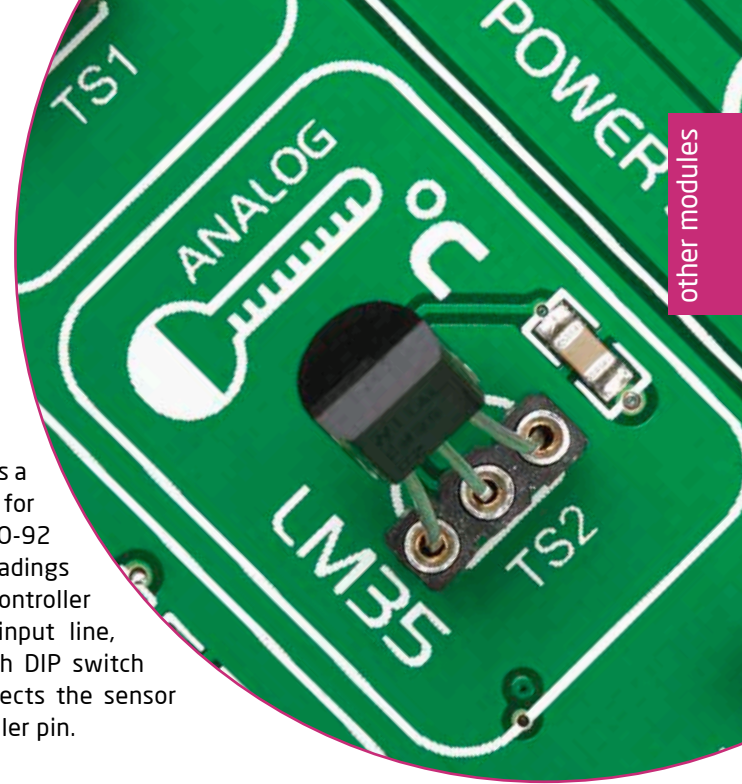

## Enabling LM35 Sensor

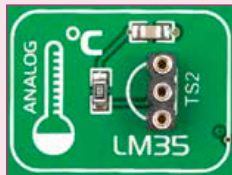

Figure 21-1:  
LM35 socket



Figure 21-2:  
LM35 correctly  
placed in socket



Figure 21-3:  
Enabled SW11.4  
DIP switch

EasyPIC Fusion™ v7 enables you to get analog readings from the LM35 sensor using **RBO** microcontroller pin. The selection of this line is done placing **SW11.4** DIP switch to ON position (**Figure 21-4**). When placing the sensor in the socket make sure that half-circle on the board silkscreen markings matches the rounded part of the LM35 sensor. If you accidentally connect the sensor the other way, it can be permanently damaged and you might need to replace it with another one. During the readings of the sensor, make sure that no other device uses the selected analog line, because it may interfere with the readings.

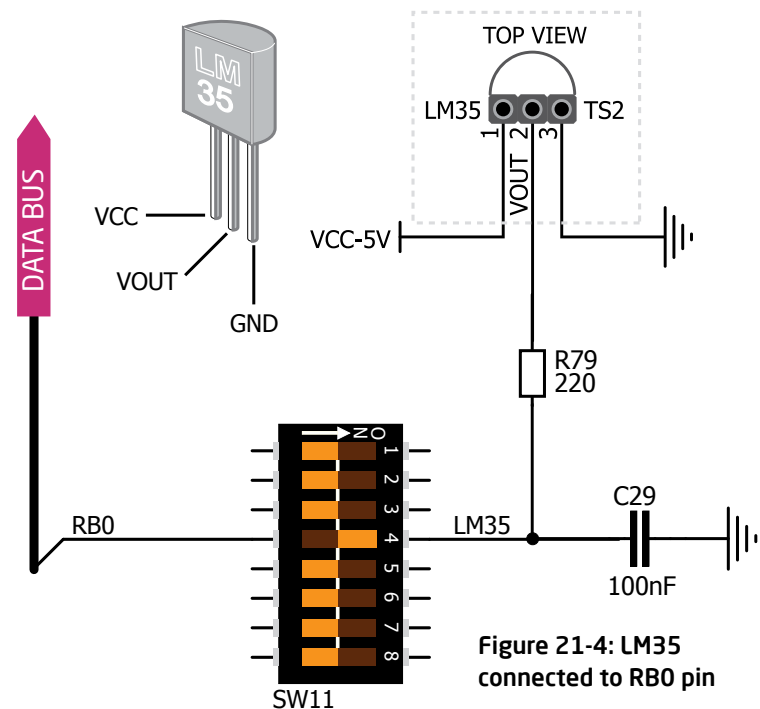
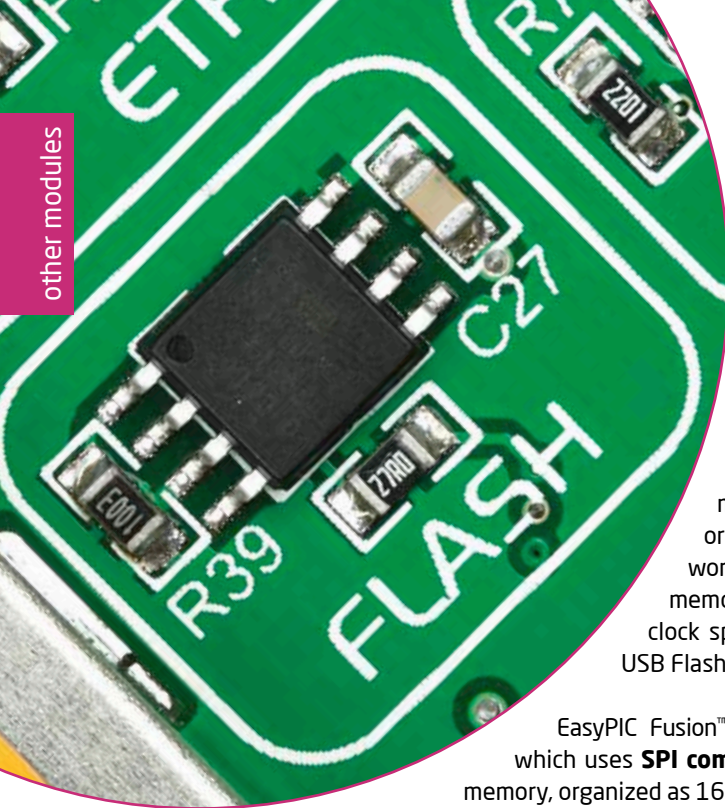

Figure 21-4: LM35  
connected to RBO pin





# Serial Flash Memory

**Flash memory** is a non-volatile storage chip that can be electrically erased and reprogrammed. It was developed from EEPROM (electrically erasable programmable read-only memory) and must be erased in fairly large blocks before these can be rewritten with new data. The high density NAND type must also be programmed and read in (smaller) blocks, or pages, while the NOR type allows a single machine word (byte) to be written or read independently. Flash memories come in different sizes and supporting different clock speeds. They are mostly used for mass storage, as in USB Flash Drives, which are very popular today.

EasyPIC Fusion™ v7 features **M25P80** serial Serial Flash Memory which uses **SPI communication interface** and has **8 Mbits** of available memory, organized as 16 sectors, each containing 256 pages. Each page is 256 bytes wide. Thus, the whole memory can be viewed as consisting of 4096 pages, or 1,048,576 bytes. Maximum clock frequency for READ instructions is 40MHz.

## What is SPI?

The **Serial Peripheral Interface Bus** or SPI bus is a synchronous serial data link standard that operates in full duplex mode. It consists of four lines **MISO** (Master Input Slave Output), **MOSI** (Master Output Slave Input), **SCK** (Clock) and **CS** (Chip Select). Devices communicate in master/slave mode where the master device initiates the data frame. Multiple slave devices are allowed with individual slave select (chip select) lines.



## Enabling Serial Flash

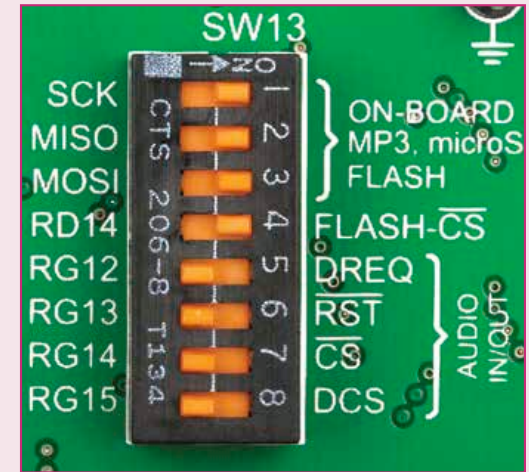

In order to connect Serial Flash Memory to the microcontroller you must enable **SW13.1**, **SW13.2**, **SW13.3** and **SW13.4** switches. This connects SPI lines to **SCK**, **MISO**, **MOSI** and **RD14** (CS) microcontroller pins.

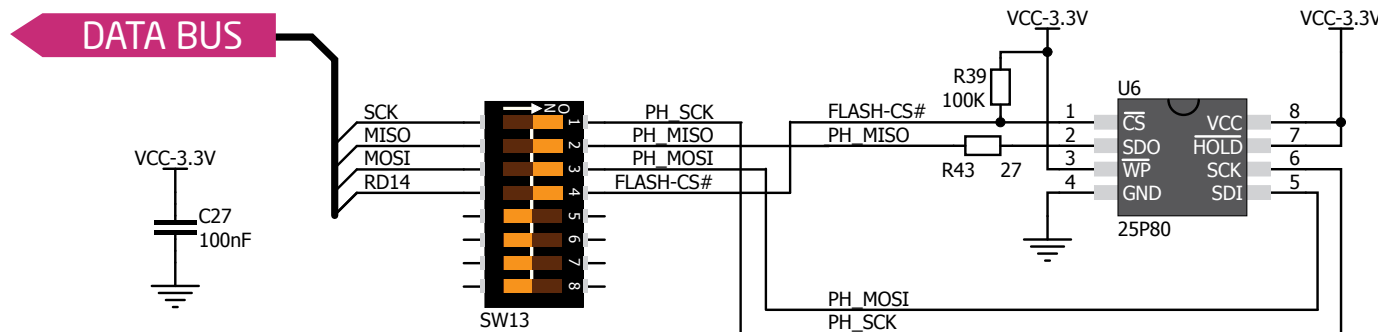
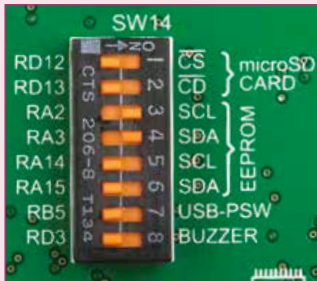

Figure 22-1: Schematic of Serial Flash Memory module

# I<sup>2</sup>C EEPROM



## Enabling I<sup>2</sup>C EEPROM



**Figure 23-2:** Activate **SW14.3** and **SW14.4** or **SW14.5** and **SW14.6** switches

In order to connect I<sup>2</sup>C EEPROM to the microcontroller you must enable **SW14.3** and **SW14.4** or **SW14.5** and **SW14.6** switches. 2K2 pull-up resistors necessary for I<sup>2</sup>C communication are already provided on **SDA** and **SCL** lines once switches are turned on. Prior to using EEPROM in your application, make sure to disconnect other peripherals, LEDs and additional pull-up or pull-down resistors from the **interface** lines in order not to interfere with signal/data integrity.

**EEPROM** is short for **Electrically Erasable Programmable Read Only Memory**. It is usually a secondary storage memory in devices containing data that is retained even if the device loses power supply. EEPROMs come with parallel or serial interface to the master device. Because of the ability to alter single bytes of data, EEPROM devices are used to store personal preference and configuration data in a wide spectrum of consumer, automotive, telecommunication, medical, industrial, and PC applications.

EasyPIC Fusion™ v7 supports serial EEPROM which uses **I<sup>2</sup>C communication interface** and has **1024 bytes** of available memory. EEPROM itself supports single byte or 16-byte (page) write and read operations. Data rates are dependent of power supply voltage, and go up to **400 kHz** for 3.3V power supply.

## What is I<sup>2</sup>C?

I<sup>2</sup>C is a multi-master serial single-ended bus that is used to attach low-speed peripherals to computer or embedded systems. I<sup>2</sup>C uses only two open-drain lines, **Serial Data Line (SDA)** and **Serial Clock (SCL)**, pulled up with resistors. **SCL** line is driven by a master, while **SDA** is used as bidirectional line either by master or slave device. Up to 112 slave devices can be connected to the same bus. Each slave must have a unique address.

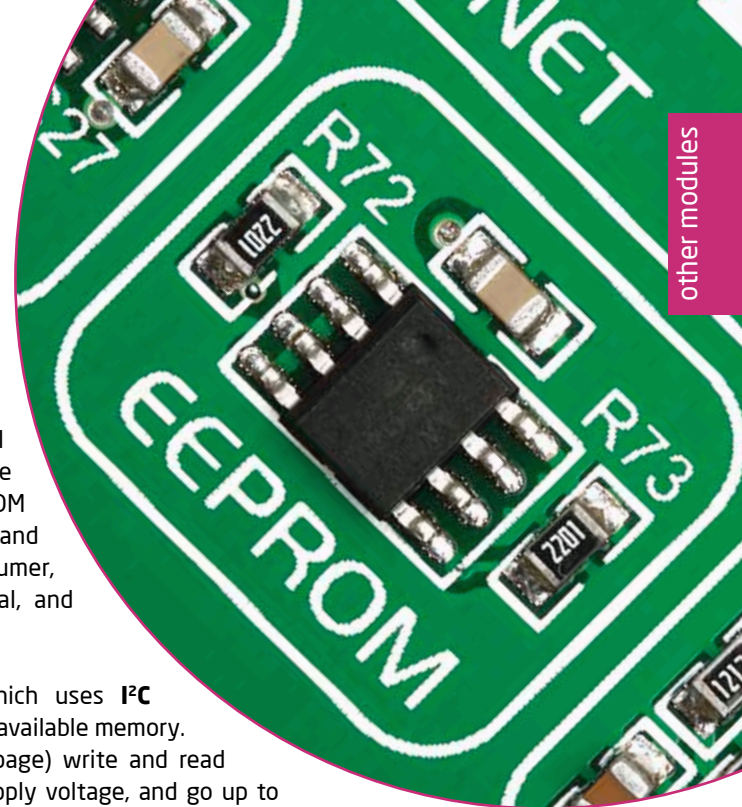

other modules

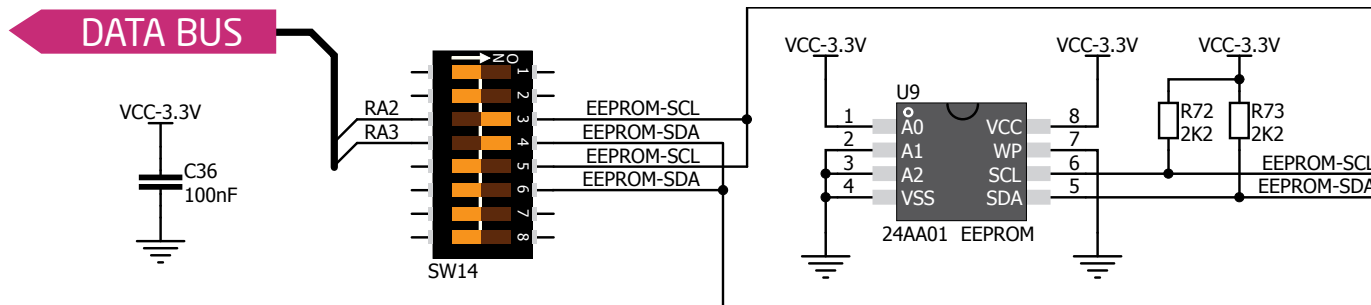

**Figure 23-1:** Schematic of I<sup>2</sup>C EEPROM module



# ADC inputs

**Digital signals** have **two discrete states**, which are decoded as **high** and **low**, and interpreted as **logic 1** and **logic 0**. **Analog signals**, on the other hand, are **continuous**, and can have any value within defined range. **A/D converters** are specialized circuits which can convert analog signals (voltages) into a digital representation, usually in form of an **integer number**. The value of this number is **linearly dependent** on the input voltage value. Most microcontrollers nowadays internally have A/D converters connected to one or more input pins. Some of the most important parameters of A/D converters are **conversion time** and **resolution**. Conversion time determines how fast can an analog voltage be represented in form of a digital number. This is an important parameter if you need fast data acquisition. The other parameter is resolution. Resolution represents the number of discrete steps that supported voltage range can be divided into. It determines

the sensitivity of the A/D converter. Resolution is represented in maximum number of bits that resulting number occupies. Most microcontrollers have 10-bit resolution, meaning that maximum value of conversion can be represented with 10 bits, which converted to integer is  $2^{10}=1024$ . This means that supported voltage range, for example from 0-3.3V, can be divided into 1024 discrete steps of about 3.222mV. EasyPIC Fusion™ v7 provides an interface in form of potentiometer for simulating analog input voltages that can be routed to any of the 5 supported analog input pins.



## Enabling ADC inputs



In order to connect the output of the potentiometer **P1** to **RB0**, **RB1**, **RB4**, **RB8** or **RB9** analog microcontroller inputs, you have to place the jumper **J8** in the desired position. By moving the potentiometer knob, you can create voltages in range from **GND** to **VCC**.

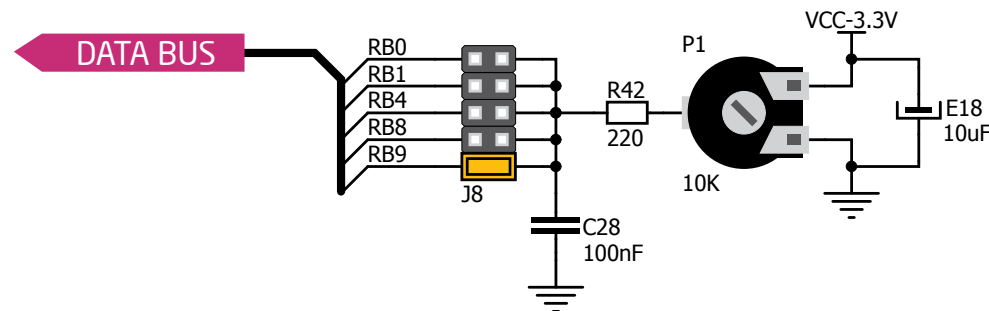

Figure 24-1:  
Schematic of ADC input



# Additional GNDs

EasyPIC Fusion™ v7 contains **GND pins** located in different sections of the board, which allow you to easily connect oscilloscope GND reference when you monitor signals on microcontroller pins, or signals of on-board modules.

- 1 GND is located just below power supply section.
- 2 GND is located below the micro SD section.
- 3 GND is located just above PORTG/L Input/Output Group.

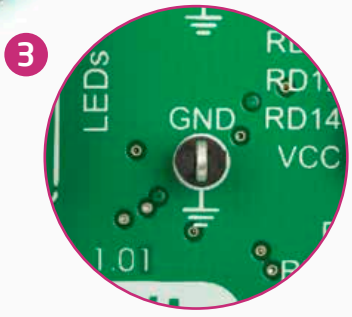
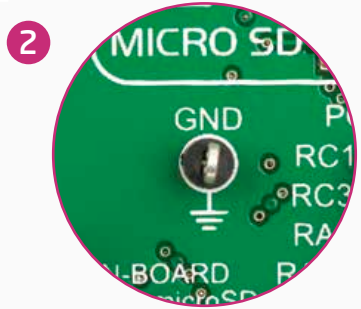
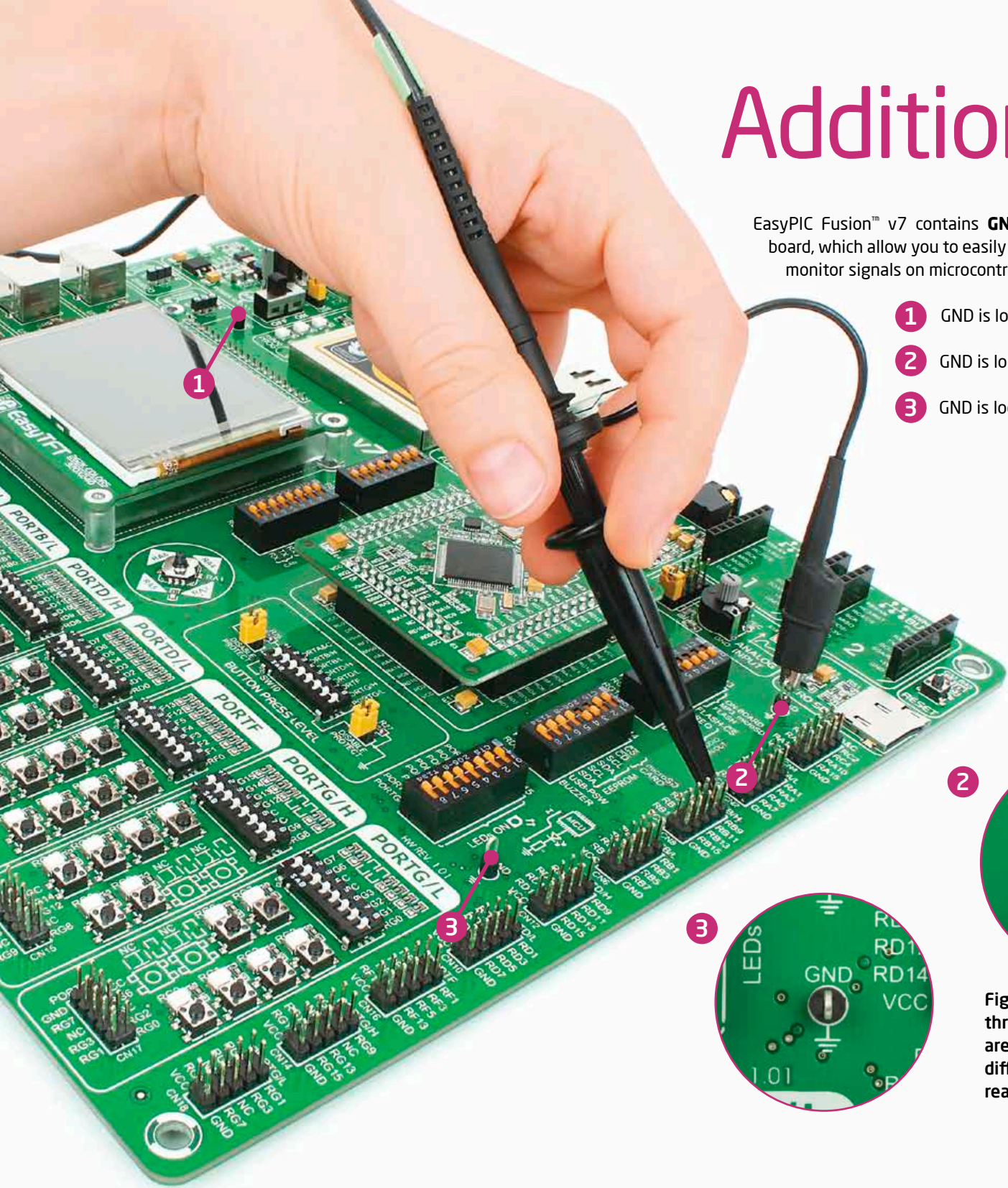

Figure 25-1:  
three oscilloscope GND pins  
are conveniently positioned so  
different parts of the board can be  
reached with an oscilloscope probe

# What's Next?

You have now completed the journey through each and every feature of **EasyPIC Fusion™ v7 board**. You got to know its modules, organization, supported microcontrollers, programmer and debugger. Now you are ready to start using your new board. We are suggesting several steps which are probably the best way to begin. We invite you to join thousands of users of EasyPIC™ brand. You will find very useful projects and tutorials and can get help from a large ecosystem of users. Welcome!

# 1

## Compiler

You still don't have an appropriate compiler? Locate **dsPIC®/PIC24®** or **PIC32® compiler** that suits you best on our website:



[www.mikroe.com/compilers/](http://www.mikroe.com/compilers/)

Choose between **mikroC™**, **mikroBasic™** and **mikroPascal™**, and download fully functional demo version, so you can begin building your dsPIC®/PIC24® and PIC32® applications.



# 2

## Projects

Once you have chosen your compiler, and since you already got the board, you are ready to start writing your first projects. We have equipped our compilers with dozens of examples that demonstrate the use of each and every feature of the EasyPIC Fusion™ v7 board, and all of our accessory boards as well. This makes an excellent starting point for your future projects. Just load the example, read well commented code, and see how it works on hardware. Browse through the compiler **Examples** on this link:



[www.mikroe.com/easypic-fusion/](http://www.mikroe.com/easypic-fusion/)

# 3

## Community

If you want to find answers to your questions on many interesting topics we invite you to visit our forum at <http://www.mikroe.com/forum> and browse through more than 150 thousand posts. You are likely to find just the right information for you. On the other hand, if you want to download free projects and libraries, or share your own code, please visit the **Libstock™ website**. With user profiles, you can get to know other programmers, and subscribe to receive notifications on their code.



[www.libstock.com/](http://www.libstock.com/)

# 4

## Support

We all know how important it is that we can rely on someone in moments when we are stuck with our projects, facing a deadline, or when we just want to ask a simple, basic question, that's pulling us back for a while. We do understand how important this is to people and therefore our Support Department is one of the pillars upon which our company is based. MikroElektronika offers **Free Tech Support** to the end of product lifetime, so if something goes wrong, we are ready and willing to help!



[www.mikroe.com/support/](http://www.mikroe.com/support/)



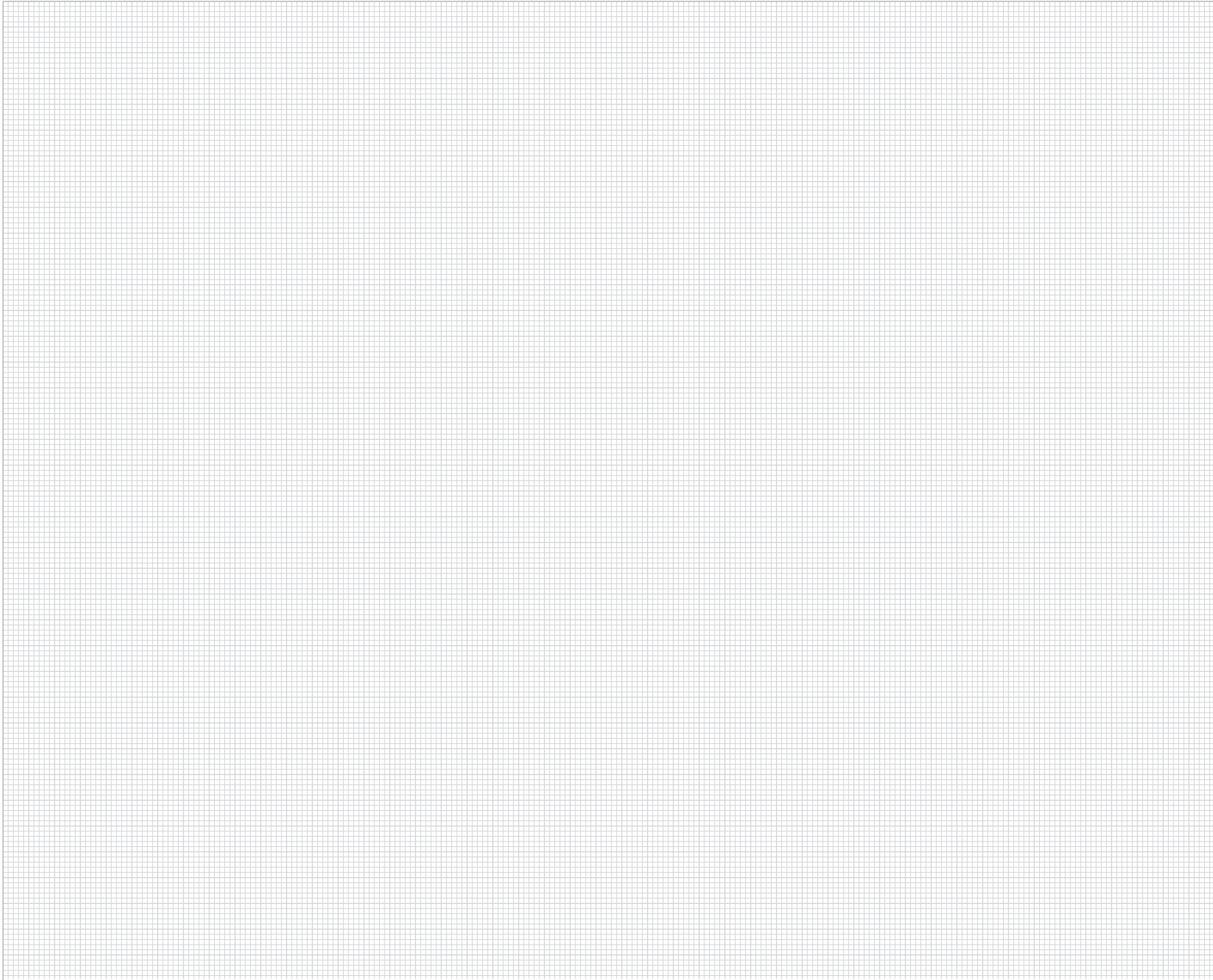

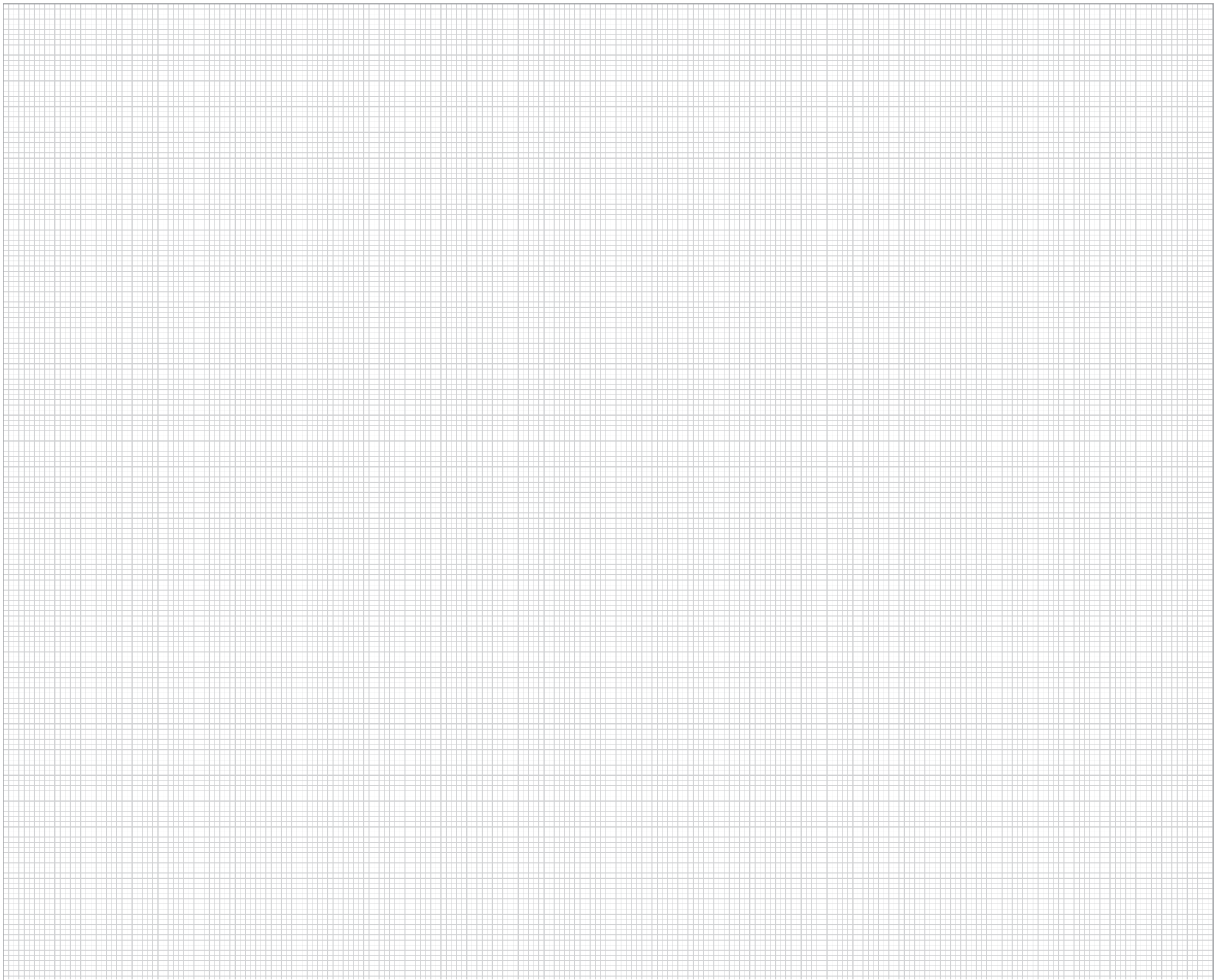



# DISCLAIMER

All the products owned by MikroElektronika are protected by copyright law and international copyright treaty. Therefore, this manual is to be treated as any other copyright material. No part of this manual, including product and software described herein, must be reproduced, stored in a retrieval system, translated or transmitted in any form or by any means, without the prior written permission of MikroElektronika. The manual PDF edition can be printed for private or local use, but not for distribution. Any modification of this manual is prohibited.

MikroElektronika provides this manual 'as is' without warranty of any kind, either expressed or implied, including, but not limited to, the implied warranties or conditions of merchantability or fitness for a particular purpose.

MikroElektronika shall assume no responsibility or liability for any errors, omissions and inaccuracies that may appear in this manual. In no event shall MikroElektronika, its directors, officers, employees or distributors be liable for any indirect, specific, incidental or consequential damages (including damages for loss of business profits and business information, business interruption or any other pecuniary loss) arising out of the use of this manual or product, even if MikroElektronika has been advised of the possibility of such damages. MikroElektronika reserves the right to change information contained in this manual at any time without prior notice, if necessary.

## HIGH RISK ACTIVITIES

The products of MikroElektronika are not fault-tolerant nor designed, manufactured or intended for use or resale as on-line control equipment in hazardous environments requiring fail-safe performance, such as in the operation of nuclear facilities, aircraft navigation or communication systems, air traffic control, direct life support machines or weapons systems in which the failure of Software could lead directly to death, personal injury or severe physical or environmental damage ('High Risk Activities'). MikroElektronika and its suppliers specifically disclaim any expressed or implied warranty of fitness for High Risk Activities.

## TRADEMARKS

The MikroElektronika name and logo, the MikroElektronika logo, mikroC™, mikroBasic™, mikroPascal™, mikroProg™, mikromedia™, EasyPIC™, workStation™, Click boards™ and mikroBUS™ are trademarks of MikroElektronika. All other trademarks mentioned herein are property of their respective companies.

All other product and corporate names appearing in this manual may or may not be registered trademarks or copyrights of their respective companies, and are only used for identification or explanation and to the owners' benefit, with no intent to infringe.

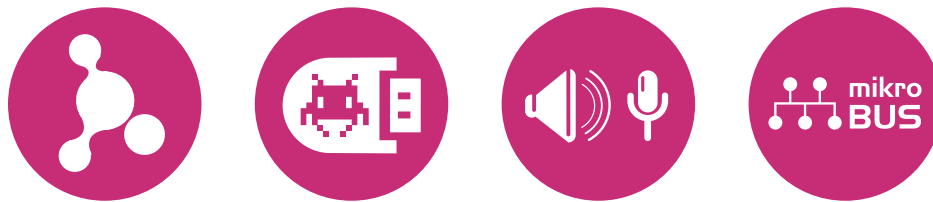

If you want to learn more about our products, please visit our website at [www.mikroe.com](http://www.mikroe.com)

If you are experiencing some problems with any of our products or just need additional information, please place your ticket at [www.mikroe.com/support/](http://www.mikroe.com/support/)

If you have any questions, comments or business proposals,  
do not hesitate to contact us at [office@mikroe.com](mailto:office@mikroe.com)

EasyPIC FUSION v7 Manual  
ver. 1.01b



0 100000 024997