

# Compact Line Filter for Industrial Machinery/Equipment



- Compact, space-saving design, optimized for industrial machinery
- Combines high attenuation performance with low leakage current
- Performance according to the machine tool standard EN 50370-1
- Increases also the immunity if operated directly on the mains input



### Performance indicators

Attenuation performance

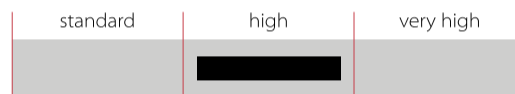

Rated current [A]

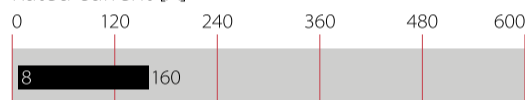

### Approvals & Compliances



### Features and Benefits

- An extremely compact and light weight filter design with a „cubic“ shape, requiring minimum mounting space and thus taking the constructional conditions on the mains input of machinery into account
- Simple and time-saving installation with good accessibility for automatic and hand tools
- Solid, touch-safe terminal blocks offering sufficient contacting cross section according to the EN 60204-1 installation standard, which is very common in industrial applications
- As a mains input filter for three phases and neutral line, FN 3256 ensures the compliance with the new product family standard for machine tools in mainly industrial environments EN 50370-1. Further, its use will also increase the conducted immunity of the entire installation significantly
- FN 3256 provides the attenuation performance to meet the requirements of various machine tools with up to 8 driving axes with ~10 m of motor cable each
- For easy selection and application, the filter current ratings are aligned with common fuse values

## Technical Specifications

<b>Maximum continuous operating voltage</b>	3x 520/300 VAC (480 VAC +10% possible)
<b>Operating frequency</b>	DC to 60 Hz
<b>Rated currents</b>	8 to 160 A @ 50°C
<b>High potential test voltage</b>	P/N → E 2750 VDC for 2 sec P → P 2250 VDC for 2 sec P → N 1300 VDC for 2 sec
<b>Protection category</b>	IP 20
<b>Overload capability</b>	4x rated current at switch on, 1.5x rated current for 1 minute, once per hour
<b>Temperature range (operation and storage)</b>	-25°C to +100°C (25/100/21)
<b>Flammability corresponding to</b>	UL 94 V-2 or better
<b>Design corresponding to</b>	UL 1283, CSA 22.2 No. 8 1986, IEC/EN 60939
<b>MTBF @ 50°C/400 V (Mil-HB-217F)</b>	>410,000 hours







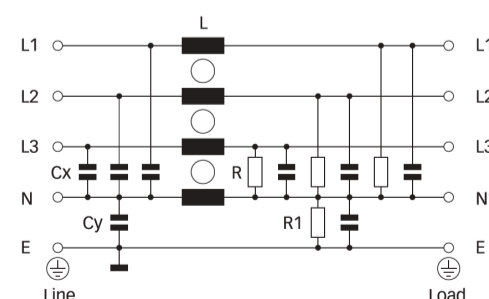









## Typical Applications

Mainly industrial equipment, machinery, machine tools and diverse process automation systems with three-phase and neutral electricity supply. Further, these filters are suitable for power supplies, high-power office equipment and further applications, where efficient interference suppression on three phases and the neutral line is required and where space is critical. Because of the very low leakage current, FN 3256 can even be used for some medical devices.

### Typical electrical schematic



### Filter Selection Table

Filter	Buy	Rated current @ 50°C (40°C)	Leakage current* @ 520 VAC/50 Hz	Power loss @ 25°C/50 Hz	Resistance** R	Resistance** R1	Input/Output connections	Weight
		[A]	[mA]	[W]	[kOhm]	[kOhm]		[kg]
FN3256H-8-29		8 (8.8)	0.6	2.7	1500	680	-29	0.6
FN3256H-16-29		16 (17.5)	0.6	5.0	1500	680	-29	0.7
FN3256H-25-33		25 (27)	0.6	9.8	1500	680	-33	1.1
FN3256H-36-33		36 (39)	0.6	11.3	1500	680	-33	1.2
FN3256H-64-34		64 (70)	0.6	17.2	1500	680	-34	2.3
FN3256H-80-35		80 (88)	0.6	14.5	1500	680	-35	3.5
FN3256H-120-35		120 (131)	0.9	25.0	1500	680	-35	4.7
FN3256H-160-40		160 (175)	1.3	26.9	1500	680	-40	5.7
FN3256H-8-29-R69		8 (8.8)	0.6	2.7	1500	10000	-29	0.6
FN3256H-16-29-R69		16 (17.5)	0.6	5.0	1500	10000	-29	0.7
FN3256H-25-33-R69		25 (27)	0.6	9.8	1500	10000	-33	1.1
FN3256H-36-33-R69		36 (39)	0.6	11.3	1500	10000	-33	1.2
FN3256H-64-34-R69		64 (70)	0.6	17.2	1500	10000	-34	2.3
FN3256H-80-35-R69		80 (88)	0.6	14.5	1500	10000	-35	3.5
FN3256H-120-35-R69		120 (131)	0.9	25.0	1500	10000	-35	4.7
FN3256H-160-40-R69		160 (175)	1.3	26.9	1500	10000	-40	5.7

\* Standardized calculated leakage current acc. IEC60939 under normal operating conditions.

\*\* Tolerances apply: Inductance: -30/+50%, Capacitance: ±20%, Resistance: ±10%

### Typical Filter Attenuation

Per CISPR 17; A=50 Ω/50 Ω sym; B=50 Ω/50 Ω asym; C=0.1 Ω/100 Ω sym; D=100 Ω/0.1 Ω sym

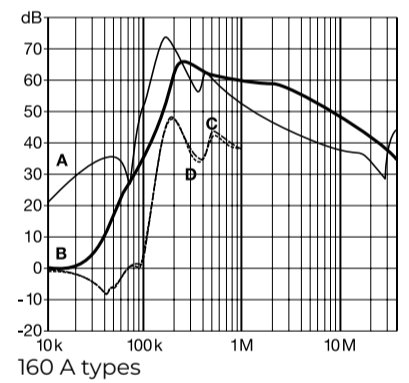
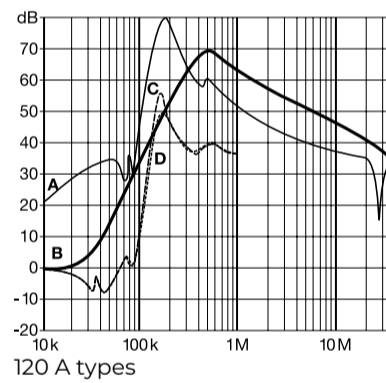
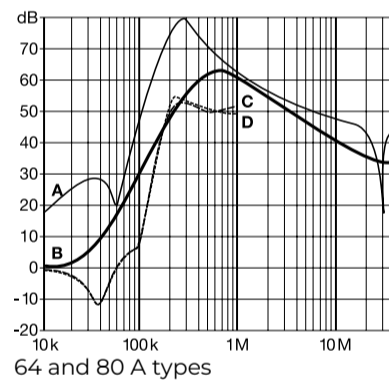
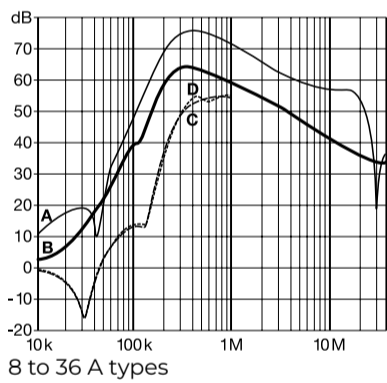

## Mechanical Data

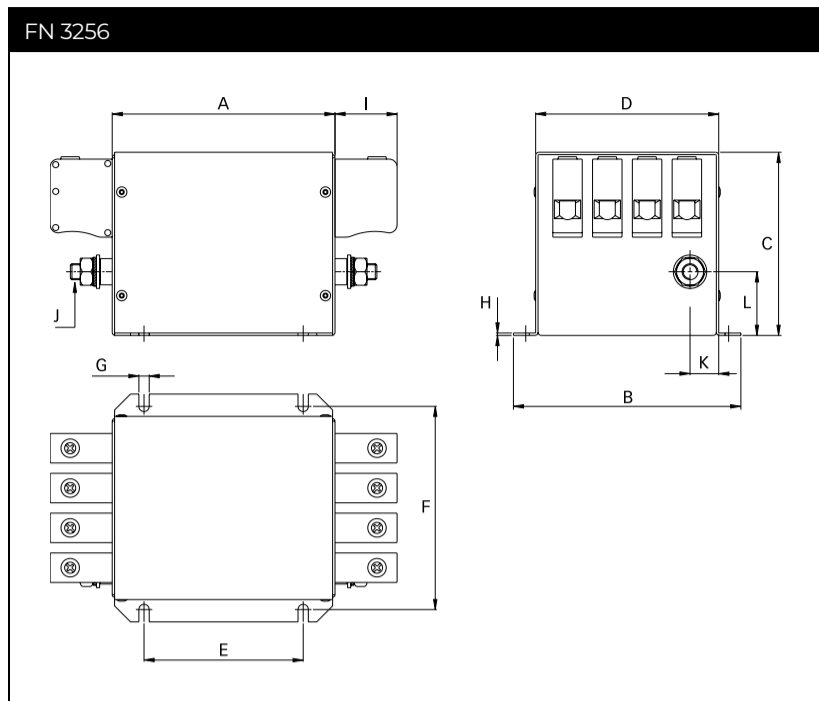

## Dimensions

	8 A	16 A	25 A	36 A	64 A	80 A	120 A	160 A
<b>A</b>	110	110	130	130	140	170	210	200
<b>B</b>	110	110	118	118	143	163	170	190
<b>C</b>	70	70	85	85	115	125	125	130
<b>D</b>	82	82	90	90	115	135	140	160
<b>E</b>	70	70	90	90	100	120	160	150
<b>F</b>	94.5	94.5	102.5	102.5	127.5	147.5	153.5	173.5
<b>G</b>	6.5	6.5	6.5	6.5	6.5	6.5	6.5	6.5
<b>H</b>	1	1	1	1	1.5	1.5	1.5	1.5
<b>I</b>	10.9	10.9	25	25	39	45	45	51
<b>J</b>	M6	M6	M6	M6	M10	M10	M10	M10
<b>K</b>	12	12	12	12	18	18	17.5	16.5
<b>L</b>	33	33	40	40	40	35	44	55

All dimensions in mm; 1 inch = 25.4 mm

Tolerances according to: ISO 2768-m/EN 22768-m

## Filter Input/Output Connector Cross Sections

	-29	-33	-34	-35	-40
<b>Solid wire</b>	6 mm <sup>2</sup>	16 mm <sup>2</sup>	35 mm <sup>2</sup>	50 mm <sup>2</sup>	95 mm <sup>2</sup>
<b>Flex wire</b>	4 mm <sup>2</sup>	10 mm <sup>2</sup>	25 mm <sup>2</sup>	50 mm <sup>2</sup>	95 mm <sup>2</sup>
<b>AWG type wire</b>	AWG 10	AWG 6	AWG 2	AWG 1/0	AWG 4/0
<b>Recommended torque</b>	0.6-0.8 Nm	1.5-1.8 Nm	4.0-4.5 Nm	7-8 Nm	17-20 Nm

Please visit [www.schaffner.com](http://www.schaffner.com) to find more details on filter connectors.

## Headquarters, Global Innovation and Development

### Switzerland

#### Schaffner Holding AG

Industrie Nord  
Nordstrasse 11e  
4542  
Luterbach  
+41 32 681 66 26  
[info@schaffner.com](mailto:info@schaffner.com)

## Sales and Application Centers

### China

#### Schaffner EMC Ltd. Shanghai

T20-3 C, No 565 Chuangye Road, Pudong district  
201201  
Shanghai  
+86 2138139500  
[cschina@schaffner.com](mailto:cschina@schaffner.com)

### Finland

#### Schaffner Oy

Sauvonrinne 19 H  
8500  
Lohja  
+358 50 468 7284  
[finlandsales@schaffner.com](mailto:finlandsales@schaffner.com)

### France

#### Schaffner EMC S.A.S.

16-20 Rue Louis Rameau  
95875  
Bezons  
+33 1 34 34 30 60  
[francesales@schaffner.com](mailto:francesales@schaffner.com)

### Germany

#### Schaffner Deutschland GmbH

Schoemperlenstrasse 12B  
76185  
Karlsruhe  
+49 721 56910  
[germanysales@schaffner.com](mailto:germanysales@schaffner.com)

### India

#### Schaffner India Pvt. Ltd

Regus World Trade Centre  
WTC, 22nd Floor Unit No 2238, Brigade Gateway Campus, 26/1, Dr. Rajkumar Road Malleshwaram (W)  
560055  
Bangalore  
+91 8067935355  
[indiasales@schaffner.com](mailto:indiasales@schaffner.com)

### Italy

#### Schaffner EMC S.r.l.

Via Ticino, 30  
20900  
Monza (MB)  
+39 039 21 41 070  
[italysales@schaffner.com](mailto:italysales@schaffner.com)

### Japan

#### Schaffner EMC K.K.

ISM Sangenjaya 7F  
1-32-12 Kamiuma, Setagaya-ku  
154-0011  
Tokyo  
+81 3 5712 3650  
[japansales@schaffner.com](mailto:japansales@schaffner.com)

### Singapore

#### Schaffner EMC Pte Ltd.

Blk 3015A Ubi Road 1, #05-09, Kampong Ubi Industrial Estate  
408705  
Singapore  
+65 63773283  
[singaporesales@schaffner.com](mailto:singaporesales@schaffner.com)

### Spain

#### Schaffner EMC España

Calle Caléndula 93, Miniparc III, Edificio E El Soto de Moraleja, Alcobendas  
28109  
Madrid  
+34 917 912 900  
[spainsales@schaffner.com](mailto:spainsales@schaffner.com)

### Sweden

#### Schaffner EMC AB

Östermalmstrorg 1  
114 42  
Stockholm  
+46 8 5050 2425  
[swedensales@schaffner.com](mailto:swedensales@schaffner.com)

### Switzerland

#### Schaffner EMV AG

Industrie Nord  
Nordstrasse 11e  
4542  
Luterbach  
+41 32 681 66 26  
[switzerlandsales@schaffner.com](mailto:switzerlandsales@schaffner.com)

### Taiwan

#### Schaffner EMV Ltd.

U-Town  
20 Floor-2, No 97, Section 1, XinTai 5th Road, XiZhi District  
22175  
New Taipei City  
+886 226975500  
[taiwansales@schaffner.com](mailto:taiwansales@schaffner.com)

### Thailand

#### Schaffner EMC Co. Ltd.

Sathorn Square Tower  
Room 3780, 37FL, 98 North-Sathorn Rd, Silom, Bangrak  
10500  
Bangkok  
+66 621056397  
[thailandsales@schaffner.com](mailto:thailandsales@schaffner.com)

### United Kingdom

#### Schaffner Ltd.

1, Oakmede Place  
Terrace Road  
RG42 4JF  
Binfield  
+44 118 9770070  
[uksales@schaffner.com](mailto:uksales@schaffner.com)

### United States

#### Schaffner EMC Inc.

52 Mayfield Avenue  
Edison, New Jersey  
+1 732 225 9533  
[usasales@schaffner.com](mailto:usasales@schaffner.com)

To find your local partner within Schaffner's global network [schaffner.com](http://schaffner.com)

© 2022 Schaffner Group

The content of this document has been carefully checked and understood. However, neither Schaffner nor its subsidiaries assume any liability whatsoever for any errors or inaccuracies of this document and the consequences thereof. Published specifications are subject to change without notice. Product suitability for any area of application must ultimately be determined by the customer. In all cases, products must never be operated outside their published specifications. Schaffner does not guarantee the availability of all published products. This disclaimer shall be governed by substantive Swiss law and resulting disputes shall be settled by the courts at the place of business of Schaffner Holding AG. Latest publications and a complete disclaimer can be downloaded from the Schaffner website. All trademarks recognized.

# Mouser Electronics

Authorized Distributor

Click to View Pricing, Inventory, Delivery & Lifecycle Information:

## Schaffner:

[FN3256H-64-34](#) [FN3256H-25-33](#) [FN3256H-120-35](#) [FN3256H-160-40](#) [FN3256H-16-29](#) [FN3256H-36-33](#) [FN3256H-80-35](#) [FN3256H-8-29](#) [FN3256H-120-35-R69](#) [FN3256H-160-40-R69](#) [FN3256H-16-29-R69](#) [FN3256H-25-33-R69](#) [FN3256H-36-33-R69](#) [FN3256H-64-34-R69](#) [FN3256H-80-35-R69](#) [FN3256H-8-29-R69](#)