

Gas Discharge Tube (GDT) Data Sheet

Features

- Provide ultra-fast response to surge voltage from slow-rising surge of 100V/s to rapid-rising surge of 1KV/μs
- Low capacitance ($\leq 1.5\text{pF}$)
- High holdover voltage
- High insulation resistance
- Stable breakdown voltage
- Large absorbing transient current capability
- Micro-Gap Design
- Operating and Storage Temperature : $-40^{\circ}\text{C} \sim +125^{\circ}\text{C}$
- Meets MSL Level 1, per J-STD-020

Applications

- Telephone Interface, Line cards
- Data communication equipment
- Line test equipment
- Repeaters, Modems

Part Number Code

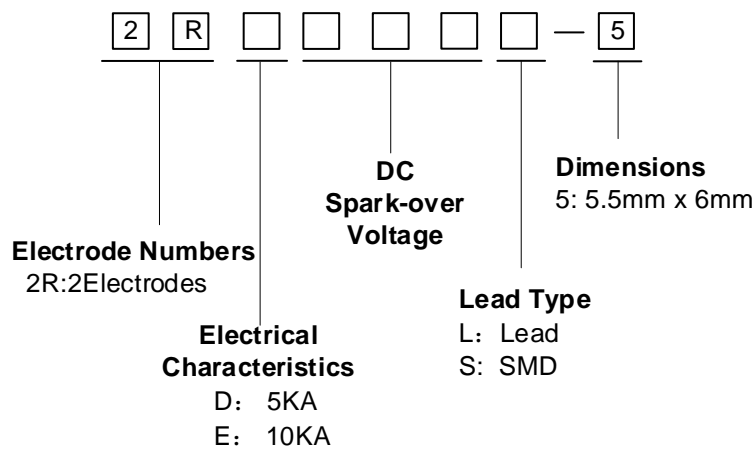

Electrical Characteristics

Part Number		DC Spark-over Voltage	Maximum Impulse Spark-over Voltage	Impulse Life Test	Minimum Insulation Resistance		Maximum Capacitance	Nominal Impulse Discharge Current	Alternating Discharge Current	Device Marking Code
		100V/S	1KV/us	10/1000us 100A	Test Voltage	(GΩ)	(1MHz 1V)	8/20us	50Hz,1S	
		(v)	(v)	(times)	DC(V)		(pF)	(KA)	(A)	
2RD070L-5	2RD070S-5	70±20%	800	300	25	1	1.5	5	5	2RD070-5
2RD075L-5	2RD075S-5	75±20%	800	300	25	1	1.5	5	5	2RD075-5
2RD090L-5	2RD090S-5	90±20%	700	300	50	1	1.5	5	5	2RD090-5
2RD120L-5	2RD120S-5	120±20%	700	300	50	1	1.5	5	5	2RD120-5
2RD150L-5	2RD150S-5	150±20%	700	300	100	1	1.5	5	5	2RD150-5
2RD230L-5	2RD230S-5	230±20%	700	300	100	1	1.5	5	5	2RD230-5
2RD250L-5	2RD250S-5	250±20%	700	300	100	1	1.5	5	5	2RD250-5
2RD300L-5	2RD300S-5	300±20%	900	300	100	1	1.5	5	5	2RD300-5
2RD350L-5	2RD350S-5	350±20%	900	300	100	1	1.5	5	5	2RD350-5
2RD400L-5	2RD400S-5	400±20%	1000	300	100	1	1.5	5	5	2RD400-5
2RD470L-5	2RD470S-5	470±20%	1100	300	250	1	1.5	5	5	2RD470-5
2RD600L-5	2RD600S-5	600±20%	1500	300	250	1	1.5	5	5	2RD600-5
2RD800L-5	2RD800S-5	800±20%	1700	300	250	1	1.5	5	5	2RD800-5

Electrical Characteristics

Part Number		DC Spark-over Voltage	Maximum Impulse Spark-over Voltage	Impulse Life Test	Minimum Insulation Resistance		Maximum Capacitance	Nominal Impulse Discharge Current	Alternating Discharge Current	Device Marking Code
		100V/S	1KV/us	10/1000us 100A	Test Voltage	(GΩ)	(1MHz 1V)	8/20us	50Hz,1S	
		(v)	(v)	(times)	DC(V)		(pF)	(KA)	(A)	
2RE070L-5	2RE070S-5	70±20%	600	500	25	1	1.5	10	10	2RE070-5
2RE075L-5	2RE075S-5	75±20%	600	500	25	1	1.5	10	10	2RE075-5
2RE090L-5	2RE090S-5	90±20%	600	500	50	1	1.5	10	10	2RE090-5
2RE120L-5	2RE120S-5	120±20%	600	500	50	1	1.5	10	10	2RE120-5
2RE150L-5	2RE150S-5	150±20%	700	500	100	1	1.5	10	10	2RE150-5
2RE230L-5	2RE230S-5	230±20%	700	500	100	1	1.5	10	10	2RE230-5
2RE250L-5	2RE250S-5	250±20%	800	500	100	1	1.5	10	10	2RE250-5
2RE300L-5	2RE300S-5	300±20%	900	500	100	1	1.5	10	10	2RE300-5
2RE350L-5	2RE350S-5	350±20%	900	500	100	1	1.5	10	10	2RE350-5
2RE400L-5	2RE400S-5	400±20%	1000	500	100	1	1.5	10	10	2RE400-5
2RE470L-5	2RE470S-5	470±20%	1100	500	250	1	1.5	10	10	2RE470-5
2RE600L-5	2RE600S-5	600±20%	1500	500	250	1	1.5	10	10	2RE600-5
2RE800L-5	2RE800S-5	800±20%	1700	500	250	1	1.5	10	10	2RE800-5

Dimensions

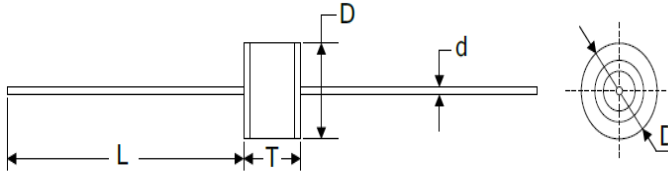
L Type	Symbol	Dimension (mm)
		D
	T	6.00±0.50
	d	0.80±0.10
	L	30 max.
S Type	D	5.50±0.50
	T	6.00±0.50
	B	0.50±0.10

Recommended Pad Size

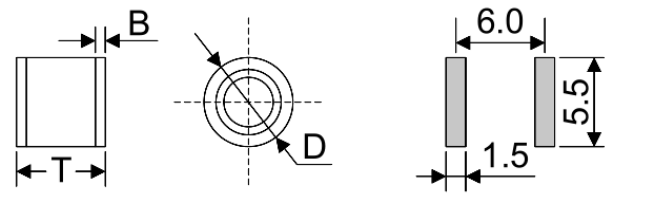

Electrical Ratings

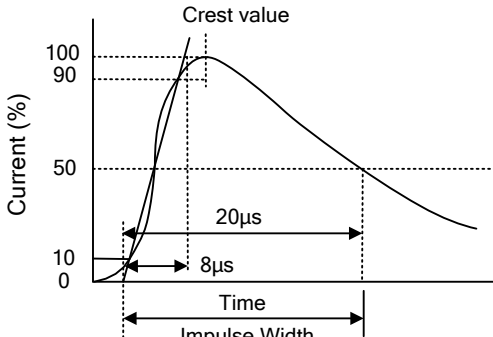
Items	Test Condition/Description	Requirement
DC spark-over voltage	The voltage is measured with voltage ramp $dv/dt=100V/s$.	To meet the Specified value
Maximum Impulse Spark-over Voltage	The maximum impulse spark-over voltage is measured with voltage ramp $dv/dt=1000V/\mu s$.	
Insulation Resistance	The resistance of gas tube shall be measured between two electrodes.	
Capacitance	The capacitance of gas tube shall be measured between two electrodes. Test frequency: 1MHz	
Impulse Discharge Current	Maximum 8/20 μs surge current that can be applied between two electrodes, 5 positive and 5 negative surges, with 3 minutes interval time, without causing the DC spark-over voltage to change more than 25% from its initial value. 	
Alternating Discharge Current	Rated RMS value of AC current at 50Hz, 1 sec. for 10 times with interval time 3 min. DC spark-over voltage shall not change more than $\pm 25\%$ from its initial value. $IR > 10^8$ ohms (-20%, +30% for 70~90V).	

Soldering Recommendation

Reflow Soldering

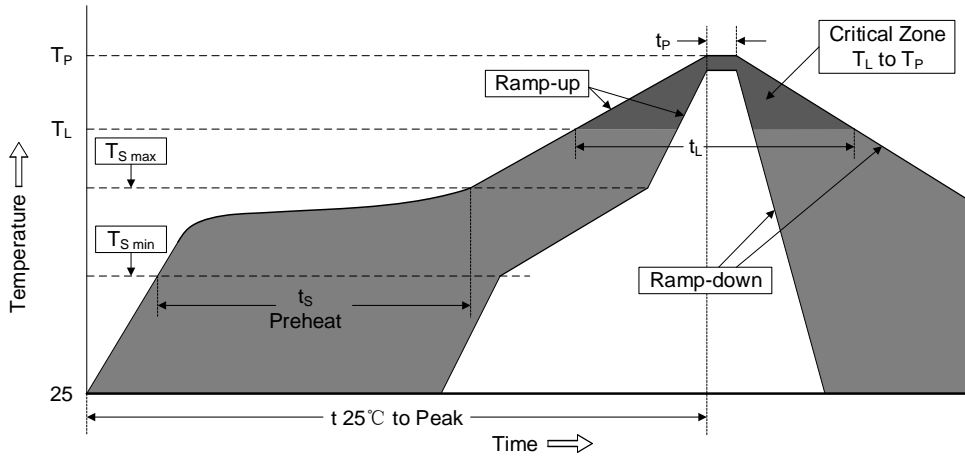

Profile Feature	Pb-Free Assembly
Average ramp-up rate (T_L to T_P)	3°C/second max.
Preheat	
-Temperature Min ($T_{S\ min}$)	150°C
-Temperature Max ($T_{S\ max}$)	200°C
-Time (min to max) (t_s)	60-180 seconds
$T_{S\ max}$ to T_L	
-Ramp-up Rate	3°C/second max.
Time maintained above:	
-Temperature (T_L)	217°C
-Time (t_L)	60-150 seconds
Peak Temperature (T_P)	260°C
Time within 5°C of actual Peak Temperature (t_p)	20-40 seconds
Ramp-down Rate	6°C/second max.
Time 25°C to Peak Temperature	8 minutes max.

Wave Soldering

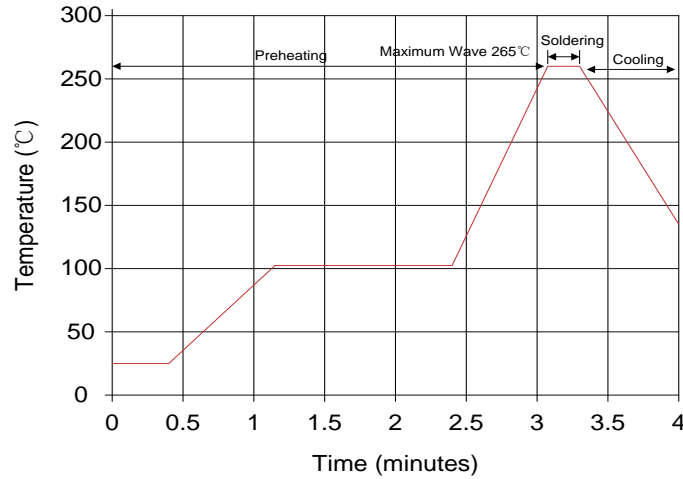

Item	Conditions
Peak Temperature	265°C
Dipping Time	10 seconds(max.)
Soldering	1 time

Packaging

Axial Packing

Skiving packing

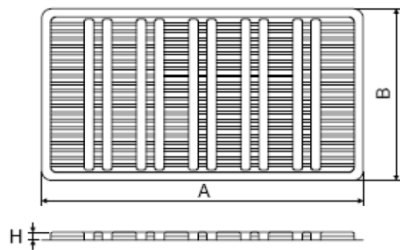

Symbol	Dimension (mm)
A	265 ± 5.0
B	146 ± 5.0
H	6.8 ± 0.5

Quantity: 100pcs

Inner box

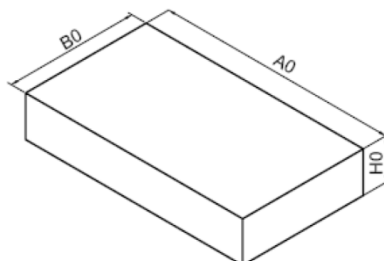

A0	270 ± 2.0
B0	150 ± 2.0
H0	50 ± 2.0

Quantity: 500pcs

Tape

P	10.0 ± 0.5
W	65.0 ± 1.0
E	6.0 ± 0.5

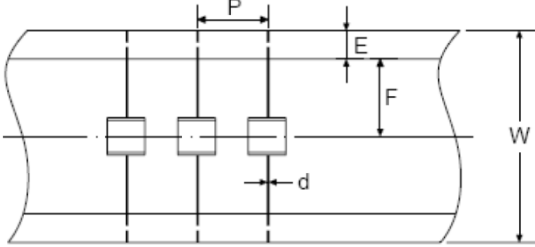
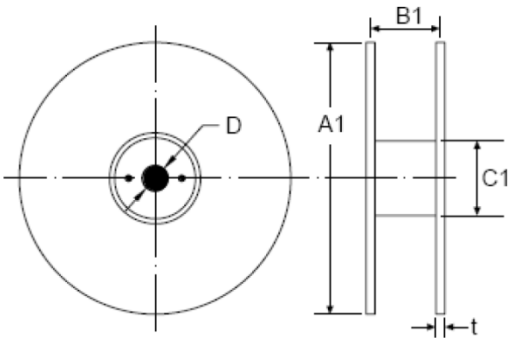
	F	26.5 ± 0.5
	d	0.8 ± 0.1
<p>Reel</p> 	A1	330.0 ± 2.0
	B1	70.0 ± 2.0
	C1	82.0 ± 2.0
	D	25.0 ± 0.5
	t	2.0 ± 0.2
	Quantity: 1000pcs	

SMD packing

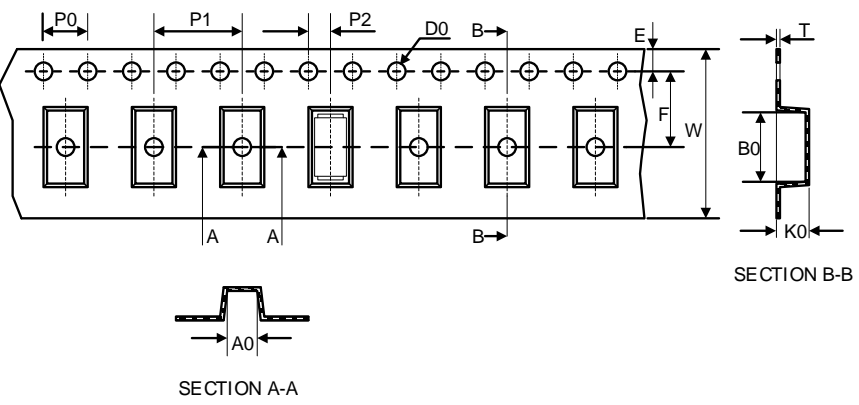
<p>Tape</p> 	Symbol	Dimension (mm)	
	W	16.00 ± 0.20	
	P0	4.00 ± 0.10	
	P1	12.00 ± 0.20	
	P2	2.00 ± 0.10	
	D0	$\Phi 1.55 \pm 0.05$	
	E	1.75 ± 0.10	
	F	7.50 ± 0.10	
	A0	5.85 ± 0.1	
	B0	7.00 ± 0.1	
	K0	6.20 ± 0.1	
	T	0.50 ± 0.1	
	<p>Reel</p>	D	330.0 ± 2.0
		d	13.0 ± 0.5

	L	20.0±2.0
	t	2.0±0.2
	Quantity: 800PCS	