

# MODULAR CONNECTORS

CL 222 TM

## Right Angle Dip Type

### ●TM5RC-\*\*(50)

CL No.	Part No.	RoHS
222-0270-9-50	TM5RC-44 (50)	YES
222-0338-0-50	TM5RC-64 (50)	
222-0337-8-50	TM5RC-66 (50)	

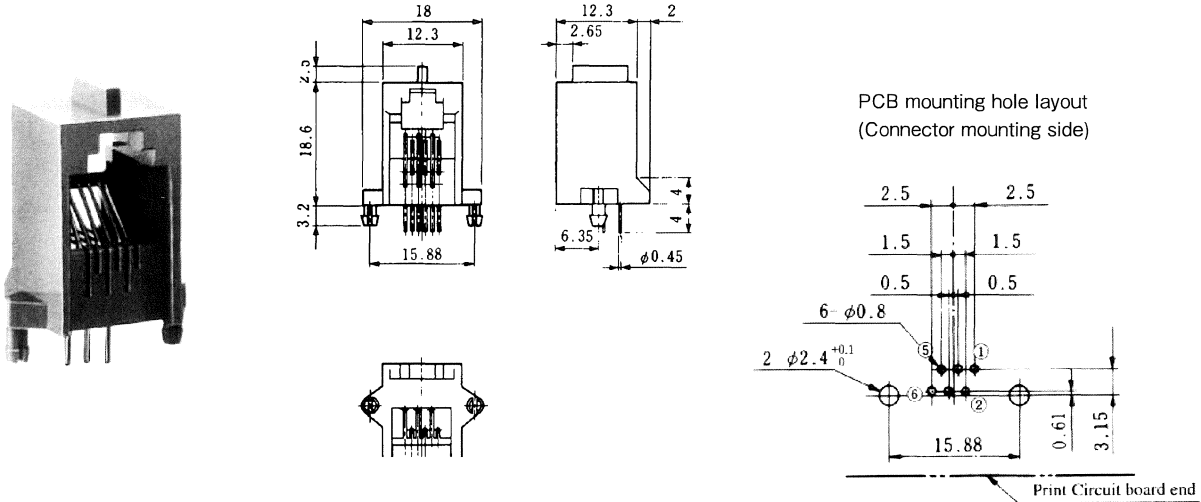

Note 1: Standard finish color is gray.

Note 2: The drawing is shown sample of TM5RC-66(50).

### ●TM5RC-88(50)

CL No.	Part No.	RoHS
222-0339-3-50	TM5RC-88 (50)	YES

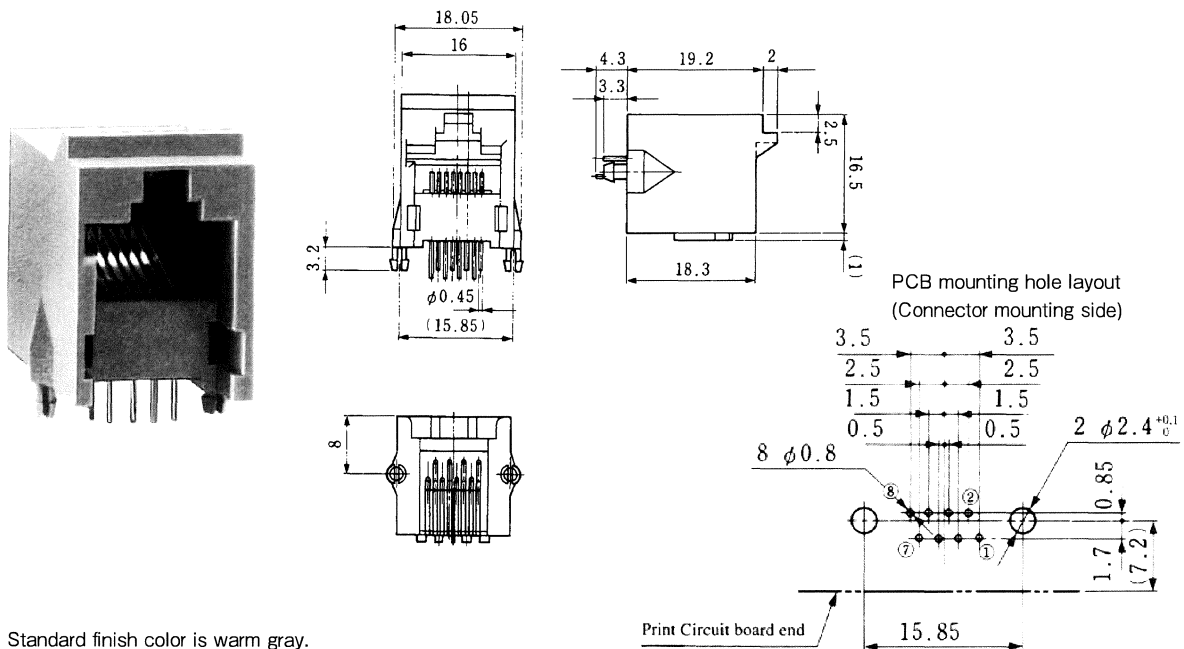

Note : Standard finish color is warm gray.

The product information in this catalog is for reference only. Please request the Engineering Drawing for the most current and accurate design information.  
 All non-RoHS products have been discontinued, or will be discontinued soon. Please check the products status on the Hirose website RoHS search at [www.hirose-connectors.com](http://www.hirose-connectors.com), or contact your Hirose sales representative.

# MODULAR CONNECTORS

## CL 222 TM

### ●TM5RE1- \*\* (20)

CL No.	Part No.	A	B	C	RoHS
222-0538-0-20	TM5RE1-44 (20)	13	10.4	8	YES
222-0539-2-20	TM5RE1-62 (20)	15	12.4	10	
222-0540-1-20	TM5RE1-64 (20)	15	12.4	10	
222-0541-4-20	TM5RE1-66 (20)	15	12.4	10	

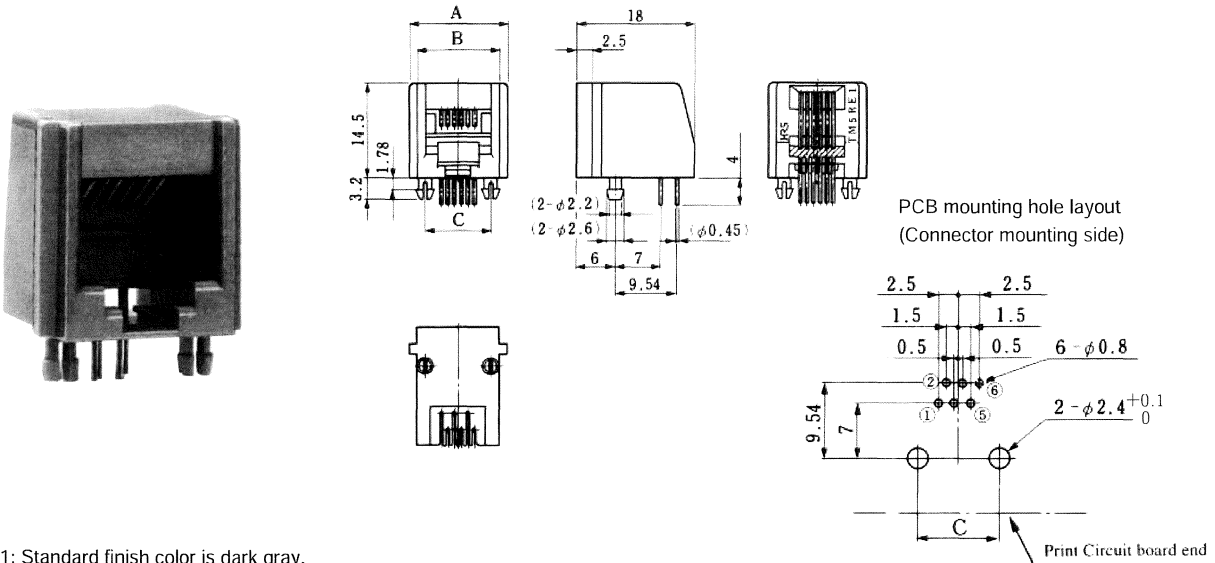

Note 1: Standard finish color is dark gray.  
 Note 2: The drawing is shown sample of TM5RE1-66 (20).

### ●TM5RE2- \*\* (20)

CL No.	Part No.	A	B	C	RoHS
222-1222-1-20	TM5RE2-44 (20)	13	10.4	10.8	YES
222-1224-7-20	TM5RE2-62 (20)	15	12.4	12.8	
222-1223-4-20	TM5RE2-64 (20)	15	12.4	12.8	
222-1225-0-20	TM5RE2-66 (20)	15	12.4	12.8	

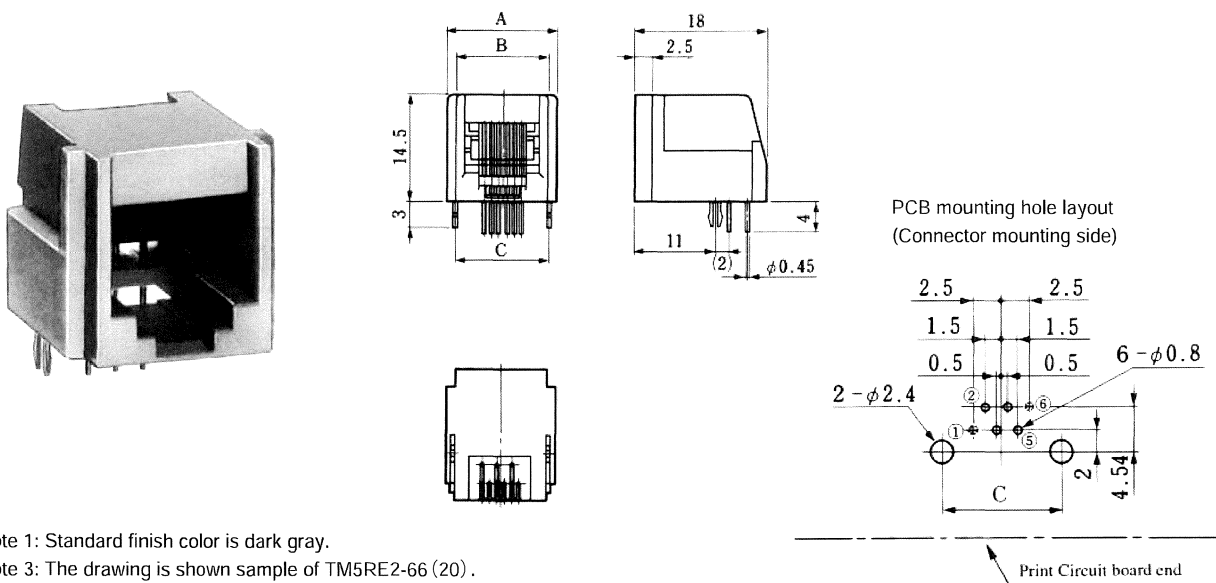

Note 1: Standard finish color is dark gray.  
 Note 3: The drawing is shown sample of TM5RE2-66 (20).

The product information in this catalog is for reference only. Please request the Engineering Drawing for the most current and accurate design information.  
 All non-RoHS products have been discontinued, or will be discontinued soon. Please check the products status on the Hirose website RoHS search at [www.hirose-connectors.com](http://www.hirose-connectors.com), or contact your Hirose sales representative.

# MODULAR CONNECTORS

CL 222 TM

● TM5RE3-\*(20)

CL No.	Part No.	A	B	C	RoHS
222-1406-4-20	TM5RE3-44 (20)	13	10.4	10.8	YES
222-1407-7-20	TM5RE3-62 (20)	15	12.4	12.8	
222-1427-4-20	TM5RE3-64 (20)	15	12.4	12.8	
222-1428-7-20	TM5RE3-66 (20)	15	12.4	12.8	
222-1702-7-20	TM5RE3-88 (20)	18.6	16	16.4	

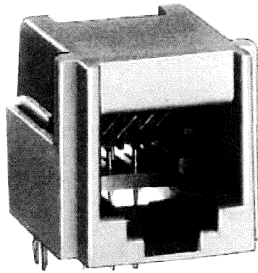

TM5RE3-66 (20)

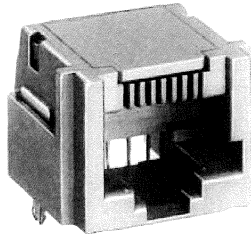

TM5RE3-88 (20)

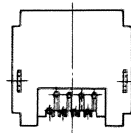
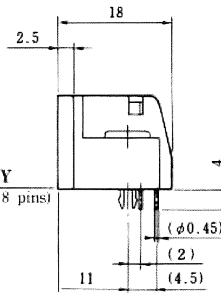
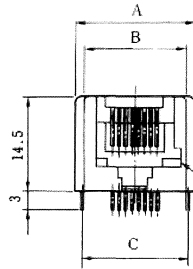

PCB mounting hole layout  
(Connector mounting side)

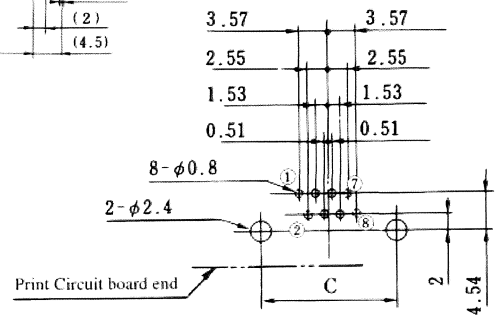

Note 1: Standard finish color is dark gray.

Note 2: The drawing is shown sample of TM5RE3-88 (20).

● TM5RF-44 (50)

CL No.	Part No.	RoHS
222-0391-3-50	TM5RF-44 (50)	YES

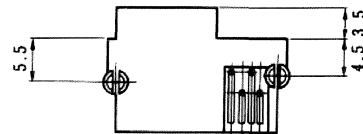
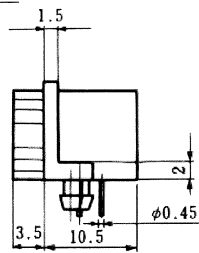
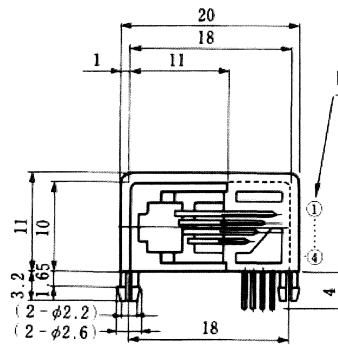
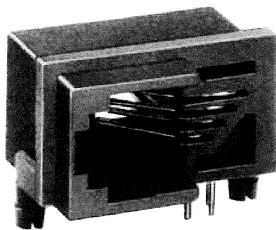

PCB mounting hole layout  
(Connector mounting side)

C.L. : Center Line

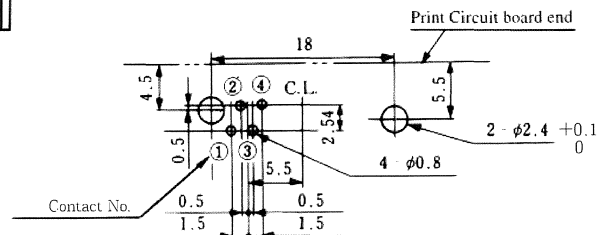

Note 1: Standard finish color is gray.

Note 2: Backboard size is shown the connector mounting side of PCB.

# MODULAR CONNECTORS

CL 222 TM

●TM5RF-6 \*(50)

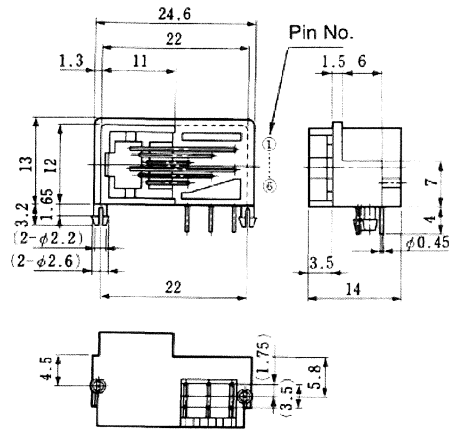
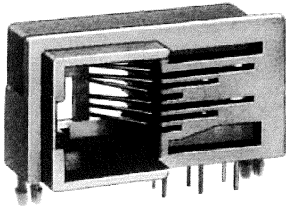

CL No.	Part No.	RoHS
222-1452-1-50	TM5RF-64 (50)	
222-1411-4-50	TM5RF-66 (50)	YES

PCB mounting hole layout  
(Connector mounting side)

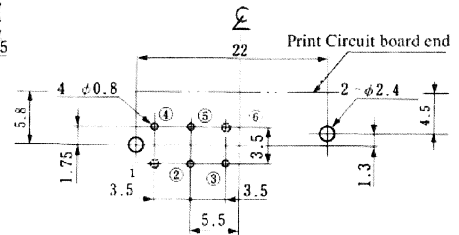

Note 1: Standard finish color is dark gray.  
Note 2: The drawing is shown sample of TM5RF-66(50).

●TM5RF-1-44 (50)

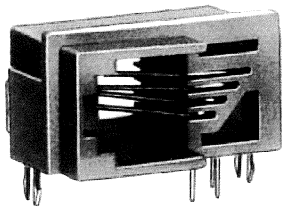

CL No.	Part No.	RoHS
222-1242-9-50	TM5RF1-44 (50)	YES

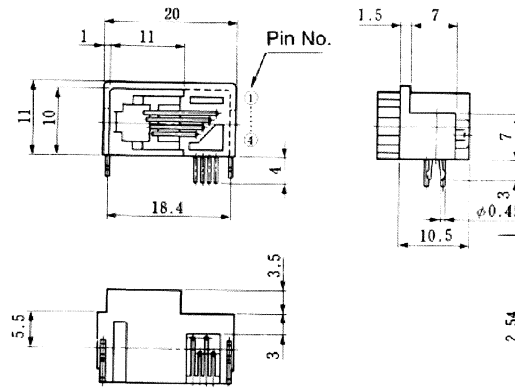

PCB mounting hole layout  
(Connector mounting side)

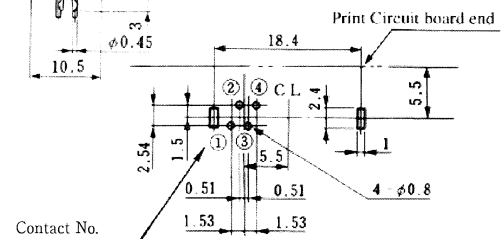

Note 1: Standard finish color is dark gray.

●TM5RF-1-6 \*(50)

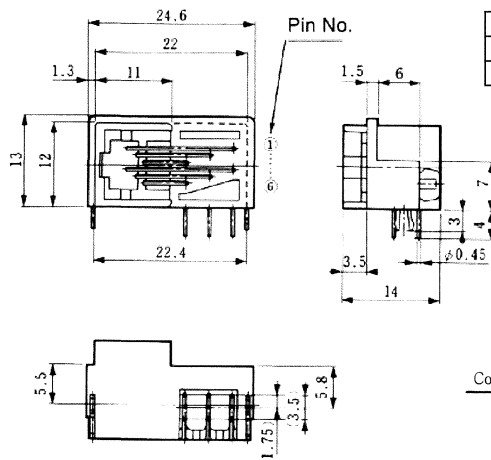
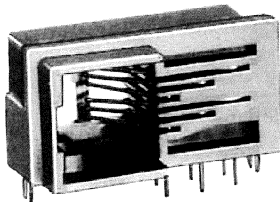

CL No.	Part No.	RoHS
222-1533-1-50	TM5RF1-64 (50)	
222-1534-4-50	TM5RF1-66 (50)	YES

PCB mounting hole layout  
(Connector mounting side)

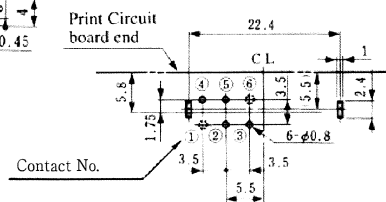

Note 1: Standard finish color is dark gray.  
Note 2: The drawing is shown sample of TM5RF1-66(50).

# MODULAR CONNECTORS

CL 222 TM

## ● TM5RJ2- \*\* (50)

CL No.	Part No.	A	B	C	RoHS
222-1459-0-50	TM5RJ2-44 (50)	12.8	10.2	10	YES
222-1486-3-50	TM5RJ2-62 (50)	14.8	12.2	12	
222-1460-0-50	TM5RJ2-64 (50)	14.8	12.2	12	
222-1461-2-50	TM5RJ2-66 (50)	14.8	12.2	12	
222-1462-5-50	TM5RJ2-88 (50)	18.6	16	15	

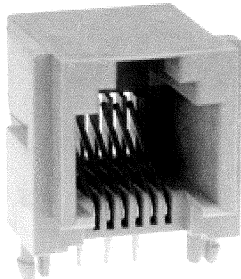

TM5RJ2-66 (50)

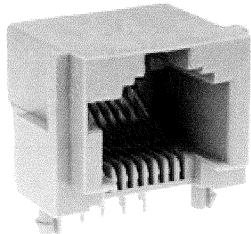

TM5RJ2-88 (50)

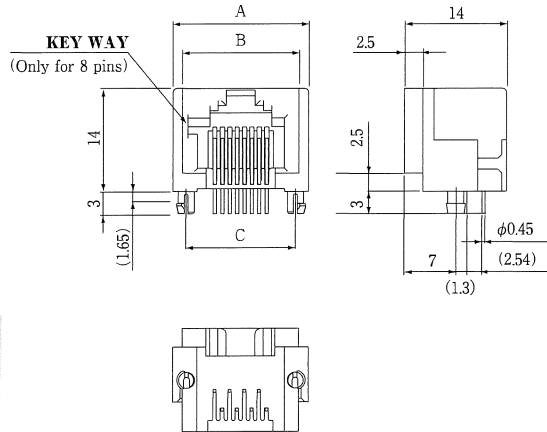

PCB mounting hole layout  
(Connector mounting side)

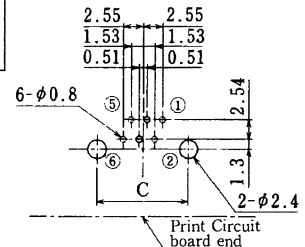

TM5RJ2-44.6\*

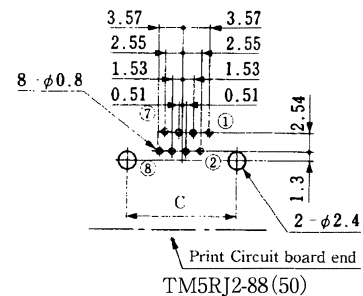

TM5RJ2-88 (50)

Note 1: Standard finish color is gray.

Note 2: The drawing is shown sample of TM5RJ2-88 (50).

## ● TM5RJ3- \*\* (50)

CL No.	Part No.	A	B	C	RoHS
222-1363-3-50	TM5RJ3-44 (50)	12.8	10.2	10.76	YES
222-1487-6-50	TM5RJ3-62 (50)	14.8	12.2	12.8	
222-1463-8-50	TM5RJ3-64 (50)	14.8	12.2	12.8	
222-1464-0-50	TM5RJ3-66 (50)	14.8	12.2	12.8	
222-1465-3-50	TM5RJ3-88 (50)	18.6	16	16.6	

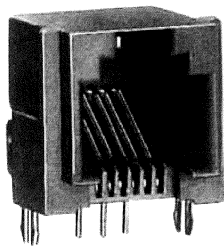

TM5RJ3-66 (50)

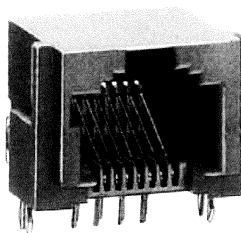

TM5RJ3-88 (50)

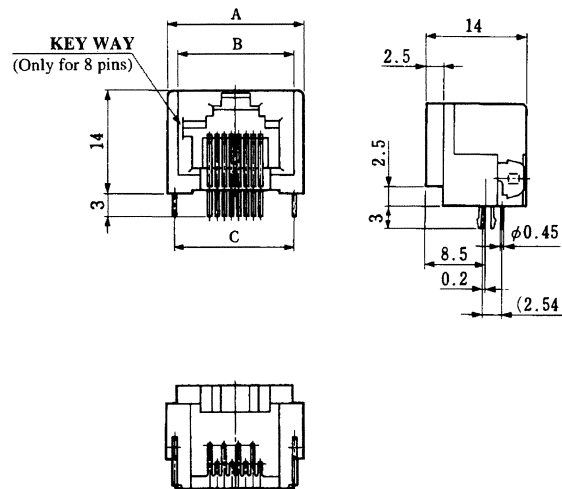

PCB mounting hole layout  
(Connector mounting side)

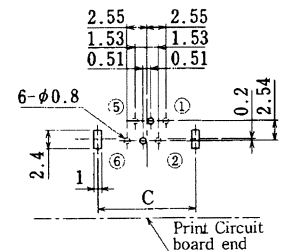

TM5RJ3-44, 6\*

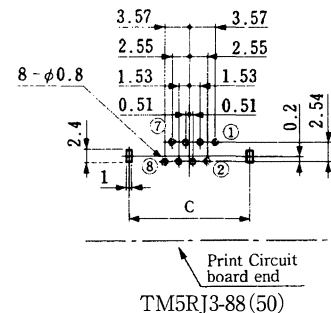

TM5RJ3-88 (50)

Note 1: Standard finish color is gray.

Note 2: The drawing is shown sample of TM5RJ3-88 (50).

# MODULAR CONNECTORS

CL 222 TM

●TM5RU-6 \*(50)

CL No.	Part No.	RoHS
222-2639-8-50	TM5RU-62 (50)	YES
222-2638-5-50	TM5RU-64 (50)	
222-2630-3-50	TM5RU-66 (50)	

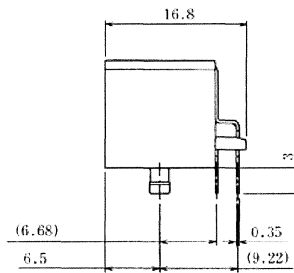
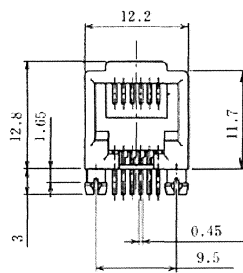
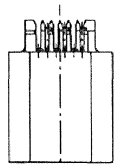
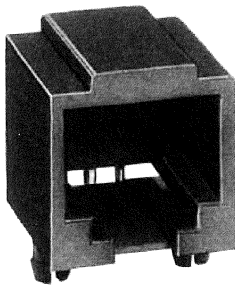

PCB mounting hole layout  
(Connector mounting side)

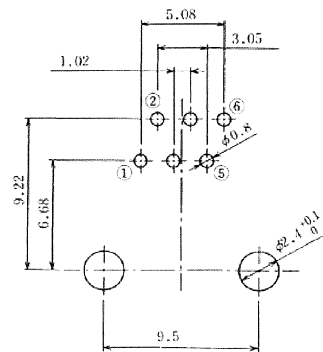

Note 1: Standard finish color is black.

Note 2: The drawing is shown sample of TM5RU-66(50).

# MODULAR CONNECTORS

CL 222 TM

## Gang-Jacks Right Angle Dip Type

### ●TM2REA-06 \*\* (50)

CL No.	Part No.	RoHS
222-1277-3-50	TM2REA-0602 (50)	YES
222-1466-6-50	TM2REA-0604 (50)	
222-1467-9-50	TM2REA-0606 (50)	

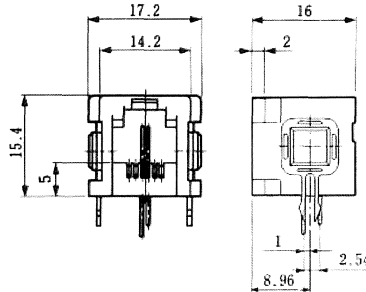
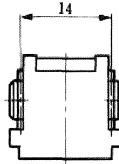
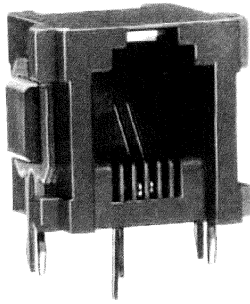

PCB mounting hole layout  
(Connector mounting side)

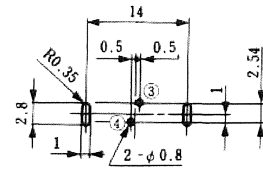

TM2REA-0602 (50)

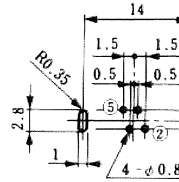

TM2REA-0604 (50)

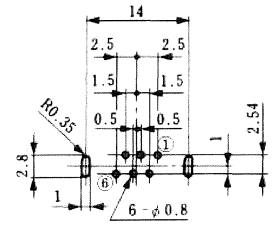

TM2REA-0606 (50)

Note 1: Standard finish color is gray.

Note 2: The drawing is shown sample of TM2REA-0602 (50).

### ●TM2REA-12 \*\* (50)

CL No.	Part No.	RoHS
222-0802-6-50	TM2REA-1204 (50)	YES
222-0799-3-50	TM2REA-1208 (50)	
222-0681-3-50	TM2REA-1212 (50)	

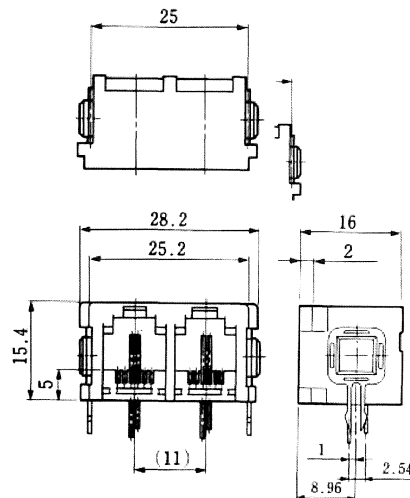
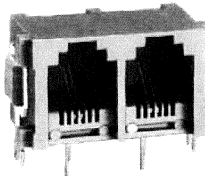

PCB mounting hole layout  
(Connector mounting side)

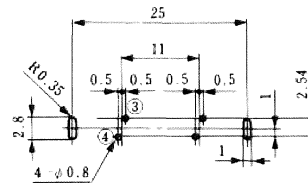

TM2REA-1204 (50)

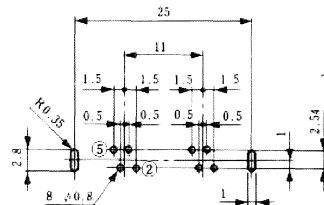

TM2REA-1208 (50)

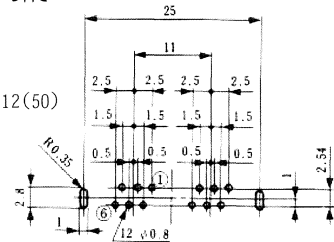

TM2REA-1212 (50)

Note 1: Standard finish color is gray.

Note 2: The drawing is shown sample of TM2REA-1204 (50).

The product information in this catalog is for reference only. Please request the Engineering Drawing for the most current and accurate design information.  
 All non-RoHS products have been discontinued, or will be discontinued soon. Please check the products status on the Hirose website RoHS search at [www.hirose-connectors.com](http://www.hirose-connectors.com), or contact your Hirose sales representative.

# MODULAR CONNECTORS

## CL 222 TM

### ● TM2REA-18 \*\* (50)

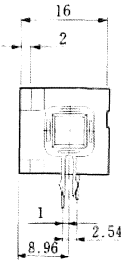
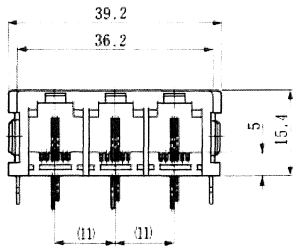
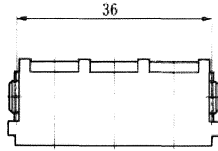
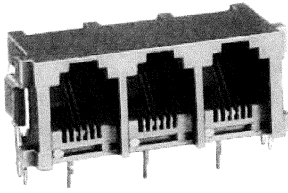

CL No.	Part No.	RoHS
222-0801-3-50	TM2REA-1806 (50)	YES
222-0798-0-50	TM2REA-1812 (50)	
222-0737-6-50	TM2REA-1818 (50)	

PCB mounting hole layout  
(Connector mounting side)

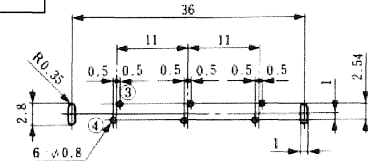

TM2REA-1806 (50)

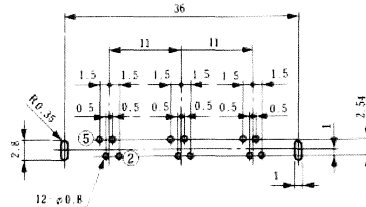

TM2REA-1812 (50)

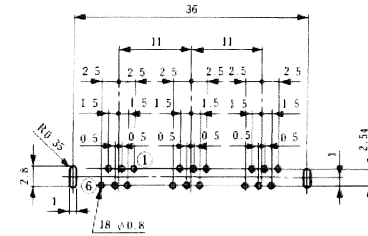

TM2REA-1818 (50)

Note 1: Standard finish color is gray.  
 Note 2: The drawing is shown sample of TM2REA-1806 (50).

### ● TM2REA-24 \*\* (50)

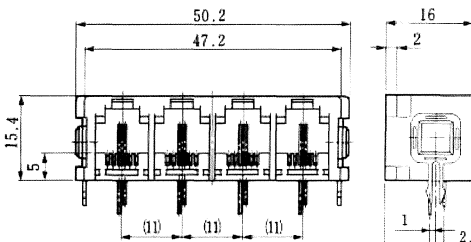
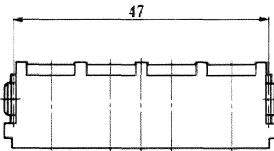
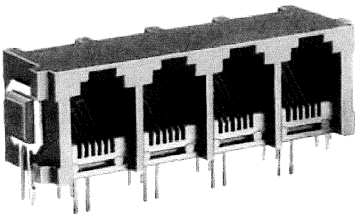

CL No.	Part No.	RoHS
222-0800-0-50	TM2REA-2408 (50)	YES
222-0749-5-50	TM2REA-2416 (50)	
222-0750-4-50	TM2REA-2424 (50)	

PCB mounting hole layout  
(Connector mounting side)

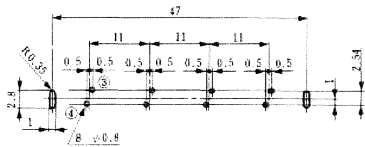

TM2REA-2408 (50)

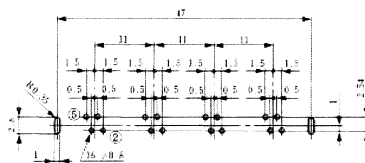

TM2REA-2416 (50)

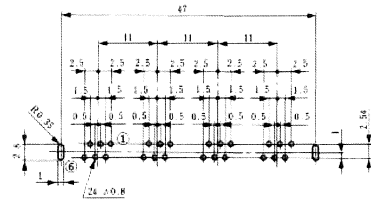

TM2REA-2424 (50)

Note 1: Standard finish color is gray.  
 Note 2: The drawing is shown sample of TM2REA-2416 (50).



The product information in this catalog is for reference only. Please request the Engineering Drawing for the most current and accurate design information.  
 All non-RoHS products have been discontinued, or will be discontinued soon. Please check the products status on the Hirose website RoHS search at [www.hirose-connectors.com](http://www.hirose-connectors.com), or contact your Hirose sales representative.

# MODULAR CONNECTORS

## CL 222 TM

### ●TM5RQ-1414 (50)

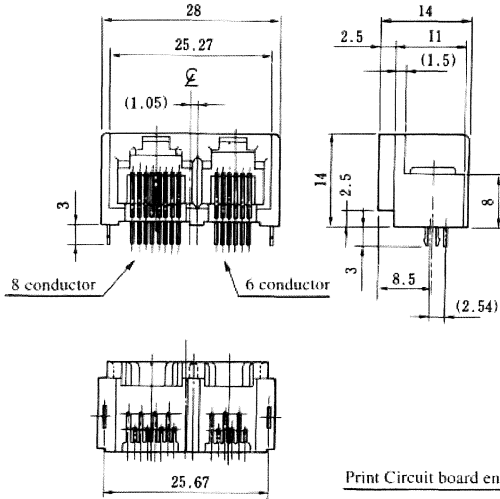
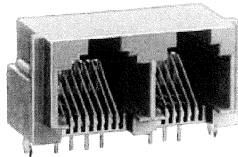

CL No.	Part No.	RoHS
222-1504-3-50	TM5RQ-1414 (50)	YES

PCB mounting hole layout  
(Connector mounting side)

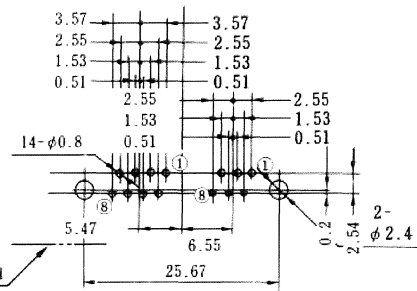

Note : Standard finish color is gray.

### ●TM5RQ-2020 (50)

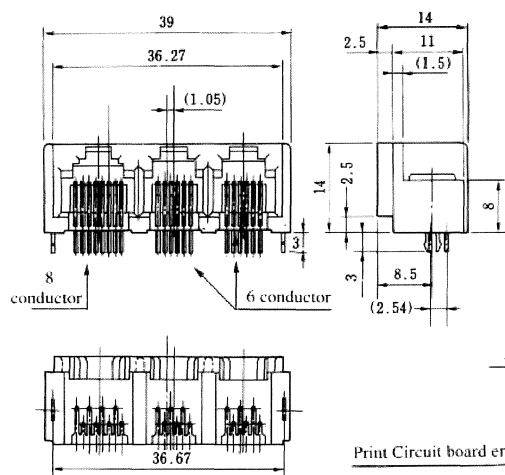
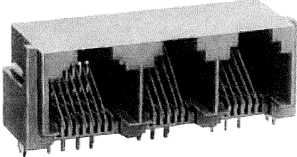

CL No.	Part No.	RoHS
222-1645-5-50	TM5RQ-2020 (50)	YES

PCB mounting hole layout  
(Connector mounting side)

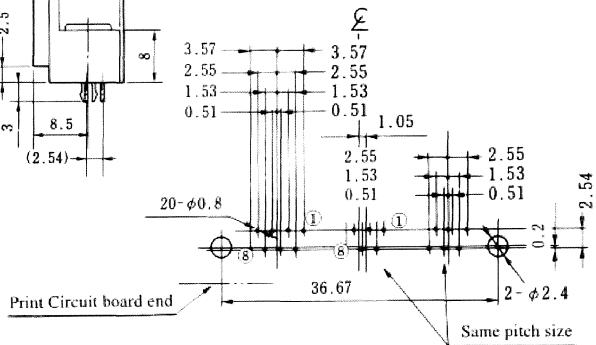

Note : Standard finish color is gray.

### ●TM5RSA-2424 (50)

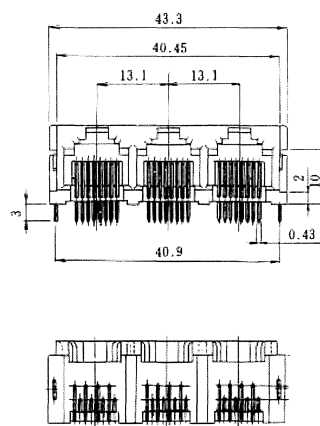
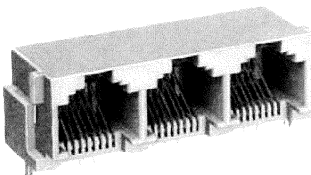

CL No.	Part No.	RoHS
222-3264-2-50	TM5RSA-2424 (50)	YES

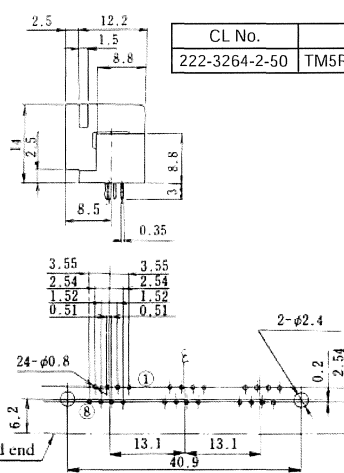

Note : Standard finish color is gray.

PCB mounting hole layout (Connector mounting side)

The product information in this catalog is for reference only. Please request the Engineering Drawing for the most current and accurate design information.  
 All non-RoHS products have been discontinued, or will be discontinued soon. Please check the products status on the Hirose website RoHS search at [www.hirose-connectors.com](http://www.hirose-connectors.com), or contact your Hirose sales representative.

# MODULAR CONNECTORS

CL 222 TM

## ●TM5RSB-1616 (50)

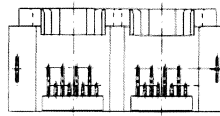
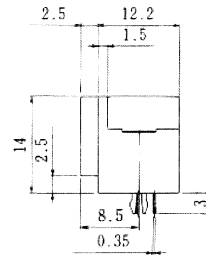
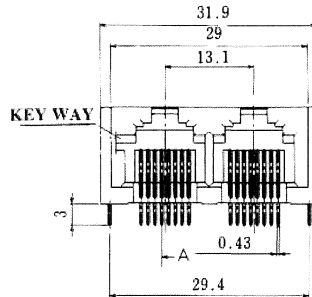
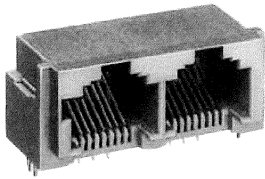

PCB mounting hole layout  
(Connector mounting side)

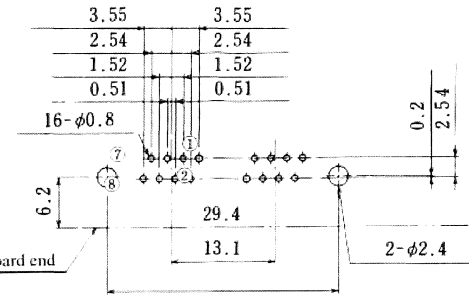

CL No.	Part No.	RoHS
222-3712-1-50	TM5RSB-1616 (50)	YES

Note : Standard finish color is gray.

## ●TM5RSB-2424 (50)

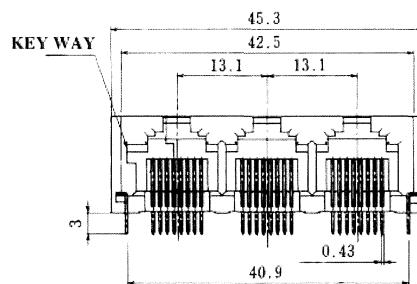
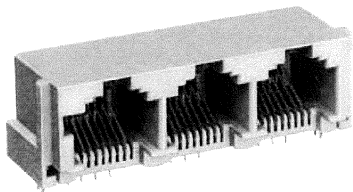

PCB mounting hole layout  
(Connector mounting side)

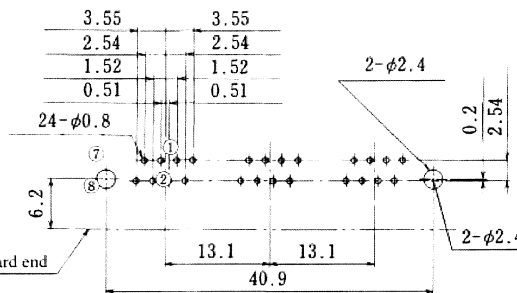

CL No.	Part No.	RoHS
222-3423-4-50	TM5RSB-2424 (50)	YES

Note : Standard finish color is gray.

# MODULAR CONNECTORS

CL 222 TM

## EIGHT-CONDUCTOR LOW PROFILE JACKS

### ●GENERAL

The TM5RL Series are small 8-contact modular connectors designed to be 11.7 mm in height and 23% smaller in volume than our former models to meet the demand for smaller and thinner electronic equipment.

### ●FEATURES

- (1) 11.7 mm in height above PCB surface (shielded jacks: 11.9 mm)
- (2) 23% smaller in volume than our former models
- (3) Space-saving: 14 mm (14.6 mm) in width and 17 mm (7.6 mm) in depth. ( ): shielded jacks
- (4) EMI-protected ferrite and shielded jacks available.
- (5) Ferrite and shielded jacks use the same connector body as standard jacks, requiring no change in the PCB for redesigning.  
(When you plan to redesign a standard PCB to a shielded PCB, select the shielding pattern in advance).
- (6) A quadruple jack is equal to or smaller in size than four TM5RL-88 jacks combined.
- (7) Plugs and jack connectors comply with the ISO 8877 Standard (ISDN interface connector).

### ●APPLICATIONS

LAN boards, HUB, ISDN terminals, and personal computers.

### ●RIGHT-ANGLE DIP TYPE

#### ●TM5RL \*-88(50)

CL No.	Part No.	Type	RoHS
222-2665-8-50	TM5RL-88 (50)	Standard	YES
222-2666-0-50	TM5RLF-88 (50)	With ferrite core	YES

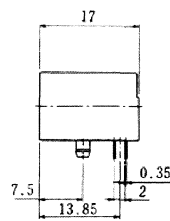
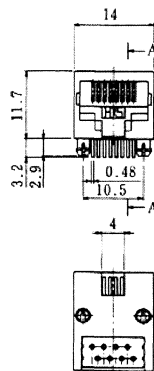
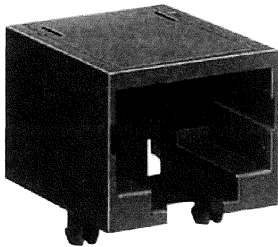

View of mating plug  
A-A

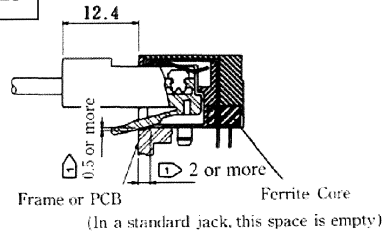

Reference mounting dimensions  
(PCB component side)

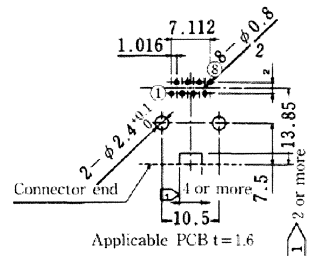

Note : When preparing frames or PCBs, follow the above  $\square$  dimensions.

# MODULAR CONNECTORS

CL 222 TM

## Quadruplet right-angle dip

●TM5RL \*-3232(50)

CL No.	Part No.	Type	RoHS
222-2671-0-50	TM5RL-3232 (50)	Standard	YES
222-2711-3-50	TM5RLF-3232 (50)	With ferrite core	YES

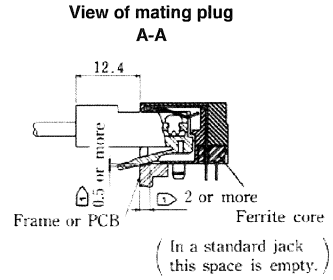
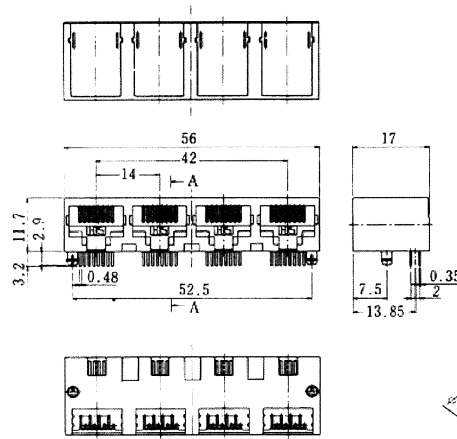
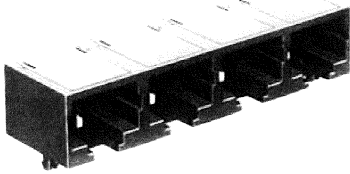

Mounting dimensions for reference (PCB mounting side)

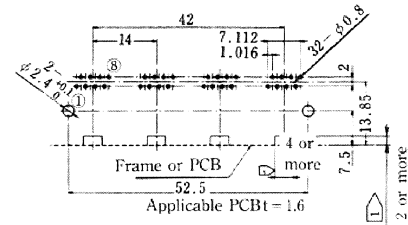

Note : When preparing frames or PCBs, provide the above  $\triangleright$  for the connector.

## Eight-conductor extension adapter

●TM5RL \*-88-JJ(50)

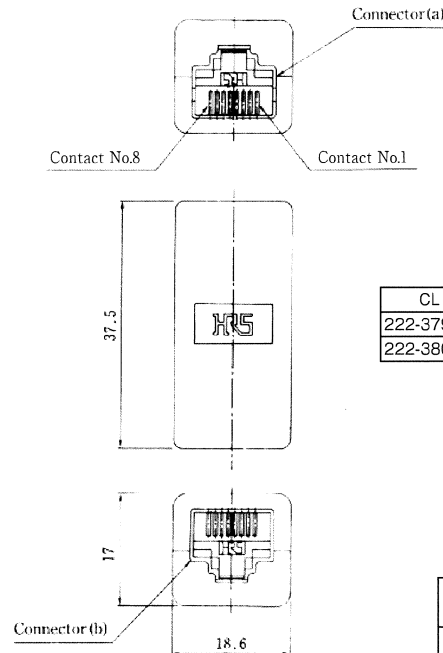
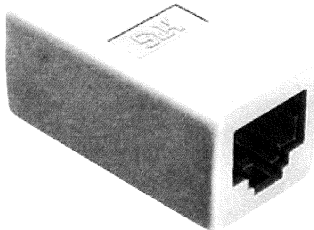

CL No.	Part No.	Type	RoHS
222-3798-7-50	TM5RL-88-JJ (50)	Standard	YES
222-3805-0-50	TM5RLF-88-JJ (50)	With ferrite core	YES

Terminal numbers

Connector(a) terminal No. TM5RL-88	1	2	3	4	5	6	7	8
Connector(b) terminal No. TM5RL-88	1	2	3	4	5	6	7	8