

# 27 V ESD Protection Diode

## Dual Line CAN Bus Protector

### NUP2105L, SZNUP2105L

The SZ/NUP2105L has been designed to protect the CAN transceiver in high-speed and fault tolerant networks from ESD and other harmful transient voltage events. This device provides bidirectional protection for each data line with a single compact SOT-23 package, giving the system designer a low cost option for improving system reliability and meeting stringent EMI requirements.

#### Features

- 350 W Peak Power Dissipation per Line (8/20  $\mu$ sec Waveform)
- Low Reverse Leakage Current (< 100 nA)
- Low Capacitance High-Speed CAN Data Rates
- IEC Compatibility:
  - IEC 61000-4-2 (ESD): Level 4, 30 kV
  - IEC 61000-4-4 (EFT): 40 A – 5/50 ns
  - IEC 61000-4-5 (Lighting) 8.0 A (8/20  $\mu$ s)
- ISO 7637-2 Pulse 2a: Repetitive Load Switch Disconnect, 9.5 A
- ISO 7637-3 Pulse 3a,b: Repetitive Load Switching Fast Transients, 50 A
- Flammability Rating UL 94 V-0
- SZ Prefix for Automotive and Other Applications Requiring Unique Site and Control Change Requirements; AEC-Q101 Qualified and PPAP Capable
- These Devices are Pb-Free, Halogen Free/BFR Free and are RoHS Compliant

#### Applications

- Industrial Control Networks
  - ◆ Smart Distribution Systems (SDS<sup>®</sup>)
  - ◆ DeviceNet<sup>™</sup>
- Automotive Networks
  - ◆ Low and High-Speed CAN
  - ◆ Fault Tolerant CAN



**ON Semiconductor<sup>®</sup>**

[www.onsemi.com](http://www.onsemi.com)

**SOT-23  
DUAL BIDIRECTIONAL  
VOLTAGE SUPPRESSOR  
350 W PEAK POWER**

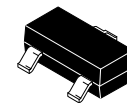

**SOT-23  
CASE 318  
STYLE 28**

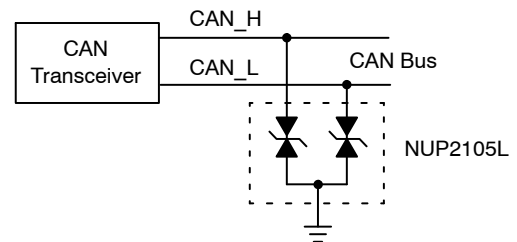
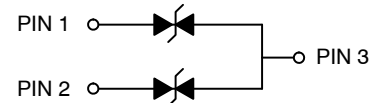

#### MARKING DIAGRAM

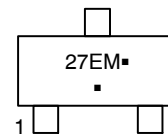

27E = Device Code  
M = Date Code  
▪ = Pb-Free Package

(Note: Microdot may be in either location)

#### ORDERING INFORMATION

See detailed ordering and shipping information in the package dimensions section on page 2 of this data sheet.

# NUP2105L, SZNUP2105L

## MAXIMUM RATINGS (T<sub>J</sub> = 25°C, unless otherwise specified)

Symbol	Rating	Value	Unit
PPK	Peak Power Dissipation 8/20 μs Double Exponential Waveform (Note 1)	350	W
T <sub>J</sub>	Operating Junction Temperature Range	-55 to 150	°C
T <sub>J</sub>	Storage Temperature Range	-55 to 150	°C
T <sub>L</sub>	Lead Solder Temperature (10 s)	260	°C
ESD	Human Body model (HBM) Machine Model (MM) IEC 61000-4-2 Specification (Contact)	16 400 30	kV V kV

Stresses exceeding those listed in the Maximum Ratings table may damage the device. If any of these limits are exceeded, device functionality should not be assumed, damage may occur and reliability may be affected.

1. Non-repetitive current pulse per Figure 1.

## ELECTRICAL CHARACTERISTICS (T<sub>J</sub> = 25°C, unless otherwise specified)

Symbol	Parameter	Test Conditions	Min	Typ	Max	Unit
V <sub>RWM</sub>	Reverse Working Voltage	(Note 2)	24	-	-	V
V <sub>BR</sub>	Breakdown Voltage	I <sub>T</sub> = 1 mA (Note 3)	26.2	-	32	V
I <sub>R</sub>	Reverse Leakage Current	V <sub>RWM</sub> = 24 V	-	1.5	100	nA
V <sub>C</sub>	Clamping Voltage	I <sub>PP</sub> = 5 A (8/20 μs Waveform) (Note 4)	-	-	40	V
V <sub>C</sub>	Clamping Voltage	I <sub>PP</sub> = 8 A (8/20 μs Waveform) (Note 4)	-	-	44	V
I <sub>PP</sub>	Maximum Peak Pulse Current	8/20 μs Waveform (Note 4)	-	-	8.0	A
C <sub>J</sub>	Capacitance	V <sub>R</sub> = 0 V, f = 1 MHz (Line to GND)	-	-	30	pF

Product parametric performance is indicated in the Electrical Characteristics for the listed test conditions, unless otherwise noted. Product performance may not be indicated by the Electrical Characteristics if operated under different conditions.

2. Surge protection devices are normally selected according to the working peak reverse voltage (V<sub>RWM</sub>), which should be equal or greater than the DC or continuous peak operating voltage level.
3. V<sub>BR</sub> is measured at pulse test current I<sub>T</sub>.
4. Pulse waveform per Figure 1.

## ORDERING INFORMATION

Device	Package	Shipping†
NUP2105LT1G	SOT-23 (Pb-Free)	3,000 / Tape & Reel
SZNUP2105LT1G*	SOT-23 (Pb-Free)	3,000 / Tape & Reel
NUP2105LT3G	SOT-23 (Pb-Free)	10,000 / Tape & Reel
SZNUP2105LT3G*	SOT-23 (Pb-Free)	10,000 / Tape & Reel

†For information on tape and reel specifications, including part orientation and tape sizes, please refer to our Tape and Reel Packaging Specifications Brochure, BRD8011/D.

\*SZ Prefix for Automotive and Other Applications Requiring Unique Site and Control Change Requirements; AEC-Q101 Qualified and PPAP Capable

# NUP2105L, SZNUP2105L

## TYPICAL PERFORMANCE CURVES

( $T_J = 25^\circ\text{C}$  unless otherwise noted)

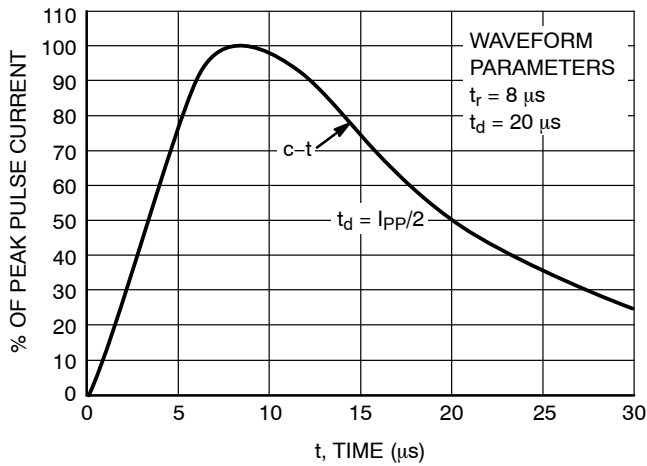

Figure 1. Pulse Waveform, IEC 61000-4-5 8/20  $\mu\text{s}$

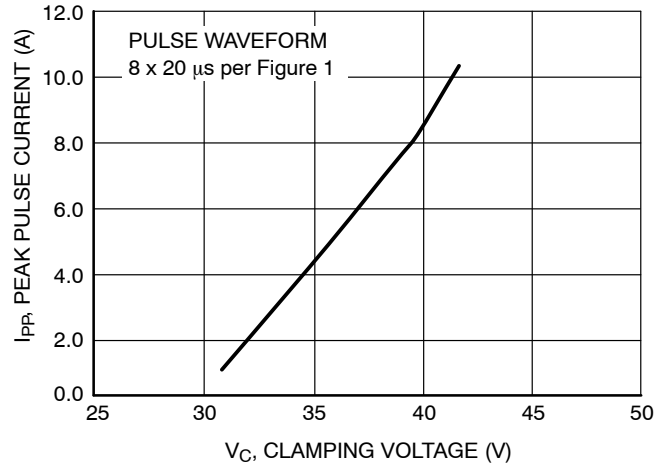

Figure 2. Clamping Voltage vs Peak Pulse Current

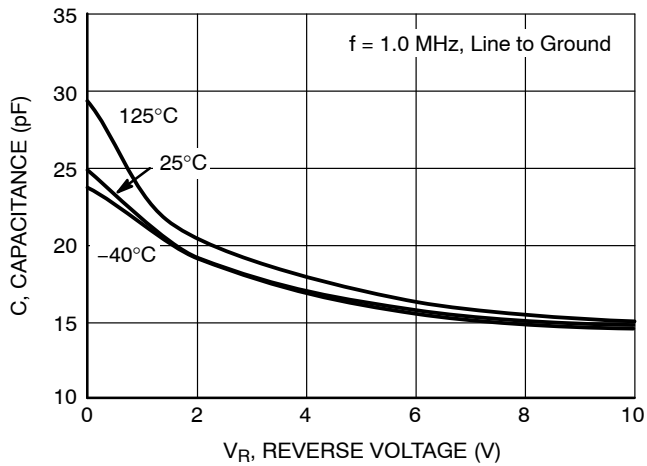

Figure 3. Typical Junction Capacitance vs Reverse Voltage

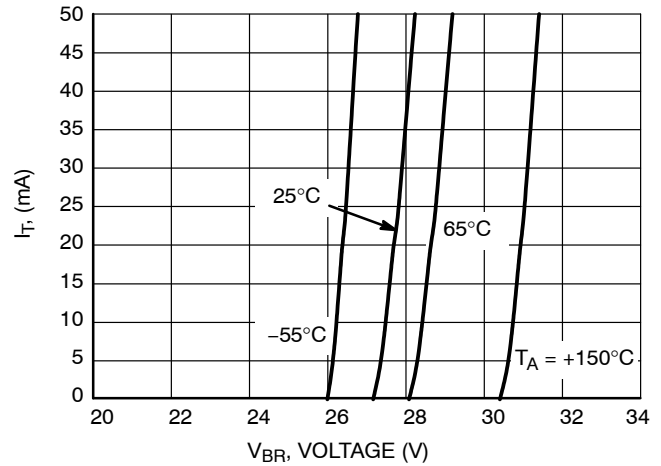

Figure 4.  $V_{BR}$  versus  $I_T$  Characteristics

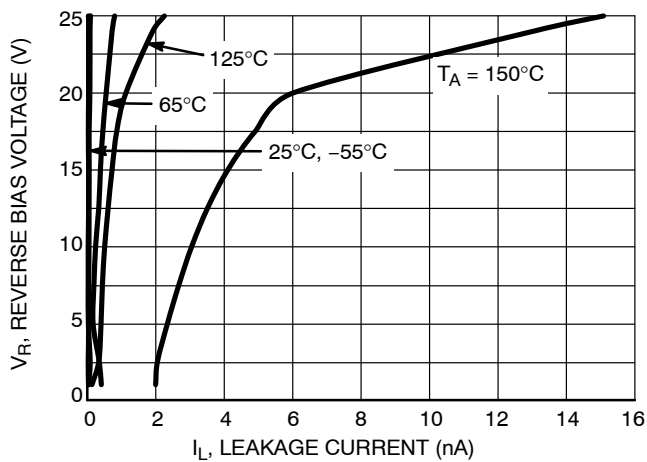

Figure 5.  $I_R$  versus Temperature Characteristics

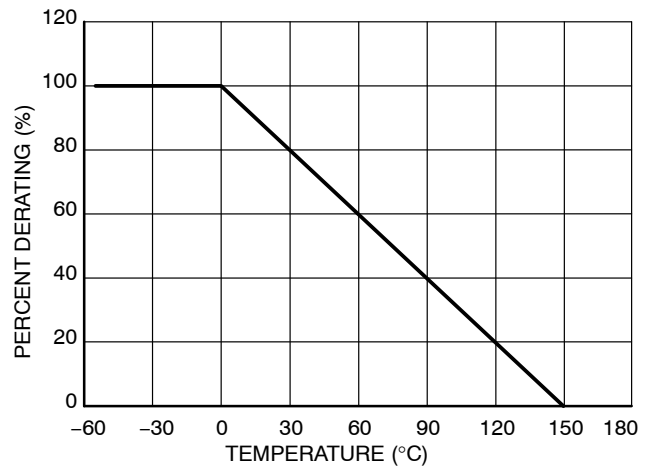

Figure 6. Temperature Power Dissipation Derating

# NUP2105L, SZNUP2105L

## APPLICATIONS

### Background

The Controller Area Network (CAN) is a serial communication protocol designed for providing reliable high speed data transmission in harsh environments. surge protection diodes provide a low cost solution to conducted and radiated Electromagnetic Interference (EMI) and Electrostatic Discharge (ESD) noise problems. The noise immunity level and reliability of CAN transceivers can be easily increased by adding external surge protection diodes to prevent transient voltage failures.

The NUP2105L provides a surge protection solution for CAN data communication lines. The NUP2105L is a dual bidirectional surge protection device in a compact SOT-23 package. This device is based on Zener technology that optimizes the active area of a PN junction to provide robust protection against transient EMI surge voltage and

ESD. The NUP2105L has been tested to EMI and ESD levels that exceed the specifications of popular high speed CAN networks.

### CAN Physical Layer Requirements

Table 1 provides a summary of the system requirements for a CAN transceiver. The ISO 11898-2 physical layer specification forms the baseline for most CAN systems. The transceiver requirements for the Honeywell® Smart Distribution Systems (SDS®) and Rockwell (Allen-Bradley) DeviceNet™ high speed CAN networks are similar to ISO 11898-2. The SDS and DeviceNet transceiver requirements are similar to ISO 11898-2; however, they include minor modifications required in an industrial environment.

**Table 1. Transceiver Requirements for High-Speed CAN Networks**

Parameter	ISO 11898-2	SDS Physical Layer Specification 2.0	DeviceNet
<b>Min / Max Bus Voltage (12 V System)</b>	-3.0 V / 16 V	11 V / 25 V	Same as ISO 11898-2
<b>Common Mode Bus Voltage</b>	CAN_L: -2.0 V (min) 2.5 V (nom) CAN_H: 2.5 V (nom) 7.0 V (max)	Same as ISO 11898-2	Same as ISO 11898-2
<b>Transmission Speed</b>	1.0 Mb/s @ 40 m 125 kb/s @ 500 m	Same as ISO 11898-2	500 kb/s @ 100 m 125 kb/s @ 500 m
<b>ESD</b>	Not specified, recommended $\geq \pm 8.0$ kV (contact)	Not specified, recommended $\geq \pm 8.0$ kV (contact)	Not specified, recommended $\geq \pm 8.0$ kV (contact)
<b>EMI Immunity</b>	ISO 7637-3, pulses 'a' and 'b'	IEC 61000-4-4 EFT	Same as ISO 11898-2
<b>Popular Applications</b>	Automotive, Truck, Medical and Marine Systems	Industrial Control Systems	Industrial Control Systems

# NUP2105L, SZNUP2105L

## EMI Specifications

The EMI protection level provided by the surge protection device can be measured using the International Organization for Standardization (ISO) 7637-2 and -3 specifications that are representative of various noise sources. The ISO 7637-2 specification is used to define the susceptibility to coupled transient noise on a 12 V power supply, while ISO 7637-3 defines the noise immunity tests for data lines. The ISO 7637 tests also verify the robustness and reliability of a design by applying the surge voltage for extended durations.

The IEC 61000-4-X specifications can also be used to quantify the EMI immunity level of a CAN system. The IEC

61000-4 and ISO 7637 tests are similar; however, the IEC standard was created as a generic test for any electronic system, while the ISO 7637 standard was designed for vehicular applications. The IEC61000-4-4 Electrical Fast Transient (EFT) specification is similar to the ISO 7637-3 pulse 3a and b tests and is a requirement of SDS CAN systems. The IEC 61000-4-5 test is used to define the power absorption capacity of a surge protection device and long duration voltage transients such as lightning. Table 2 provides a summary of the ISO 7637 and IEC 61000-4-X test specifications. Table 3 provides the NUP2105L's ESD test results.

**Table 2. ISO 7637 and IEC 61000-4-X Test Specifications**

Test	Waveform	Test Specifications	NUP2105L Results	Simulated Noise Source
ISO 7637-2 12 V Power Supply Lines (Note 2)	Pulse 1	$V_s = 0$ to $-100$ V $I_{max} = 10$ A $t_{duration} = 5000$ pulses	$I_{max} = 1.75$ A $V_{clamp\_max} = 31$ V $t_{duration} = 5000$ pulses  $R_i = 10 \Omega$ , $t_r = 1.0 \mu s$ , $t_{d\_10\%} = 2000 \mu s$ , $t_1 = 2.5$ s, $t_2 = 200$ ms, $t_3 = 100 \mu s$	DUT (Note 1) in parallel with inductive load that is disconnected from power supply.
	Pulse 2a	$V_s = 0$ to $+50$ V coupled onto 14 V battery $I_{max} = 10$ A $t_{duration} = 5000$ pulses	$I_{max} = 9.5$ A $V_{clamp\_max} = 42$ V $t_{duration} = 5000$ pulses  $R_i = 2 \Omega$ , $t_r = 1.0 \mu s$ , $t_{d\_10\%} = 50 \mu s$ , $t_1 = 2.5$ s, $t_2 = 200$ ms	DUT in series with inductor (wire harness) that is disconnected from load.
ISO 7637-3 Repetitive data line fast transients (Note 3)	Pulse 'a'	$V_s = -60$ V $I_{max} = 1.2$ A $t_{duration} = 10$ minutes	$I_{max} = 50$ A (Note 4) $V_{clamp\_max} = 40$ V $t_{duration} = 60$ minutes  $R_i = 50 \Omega$ , $t_r = 5.0$ ns, $t_{d\_10\%} = 100$ ns, $t_1 = 100 \mu s$ , $t_2 = 10$ ms, $t_3 = 90$ ms	Switching noise of inductive loads.
	Pulse 'b'	$V_s = +40$ V $I_{max} = 0.8$ A $t_{duration} = 10$ minutes		
IEC 61000-4-4 Data Line EFT		$V_{open\ circuit} = 2.0$ kV $I_{short\ circuit} = 40$ A (Level 4 = Severe Industrial Environment)  $R_i = 50 \Omega$ , $t_r < 5.0$ ns, $t_{d\_50\%} = 50$ ns, $t_{burst} = 15$ ms, $f_{burst} = 2.0$ to $5.0$ kHz, $t_{repeat} = 300$ ms $t_{duration} = 1$ minute	(Note 5)	Switching noise of inductive loads.
IEC 61000-4-5		$V_{open\ circuit} = 1.2/50 \mu s$ , $I_{short\ circuit} = 8/20 \mu s$  $R_i = 50 \Omega$	$I_{max} = 8.0$ A	Lightning, nonrepetitive power line and load switching

1. DUT = device under test.
2. Test specifications were taken from ISO7637-2: 2004 version.
3. Test specifications were taken from ISO7637-3: 1995 version.
4. DUT was tested to ISO7637-2: 2004 pulse 3a,b specification for more rigorous test.
5. The EFT immunity level was measured with test limits beyond the IEC 61000-4-4 test, but with the more severe test conditions of ISO 7637-3.

# NUP2105L, SZNUP2105L

**Table 3. NUP2105L ESD Test Results**

ESD Specification	Test	Test Level	Pass / Fail
Human Body Model	Contact	16 kV	Pass
IEC 61000-4-2	Contact	30 kV (Note 6)	Pass
	Non-contact (Air Discharge)	30 kV (Note 6)	Pass

6. Test equipment maximum test voltage is 30 kV.

### Surge protection Diode Protection Circuit

surge protection diodes provide protection to a transceiver by clamping a surge voltage to a safe level. surge protection diodes have high impedance below and low impedance above their breakdown voltage. A surge protection Zener diode has its junction optimized to absorb the high peak energy of a transient event, while a standard Zener diode is designed and specified to clamp a steady state voltage.

Figure 7 provides an example of a dual bidirectional surge protection diode array that can be used for protection with the high-speed CAN network. The bidirectional array is created from four identical Zener surge protection diodes. The clamping voltage of the composite device is equal to the

breakdown voltage of the diode that is reversed biased, plus the diode drop of the second diode that is forward biased.

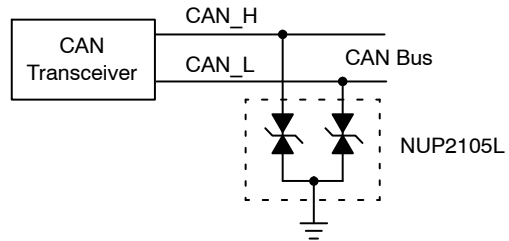
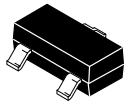

**Figure 7. High-Speed and Fault Tolerant CAN Surge Protection Circuit**

# MECHANICAL CASE OUTLINE

## PACKAGE DIMENSIONS

ON Semiconductor®



**SOT-23 (TO-236)**  
**CASE 318-08**  
**ISSUE AS**

DATE 30 JAN 2018

SCALE 4:1

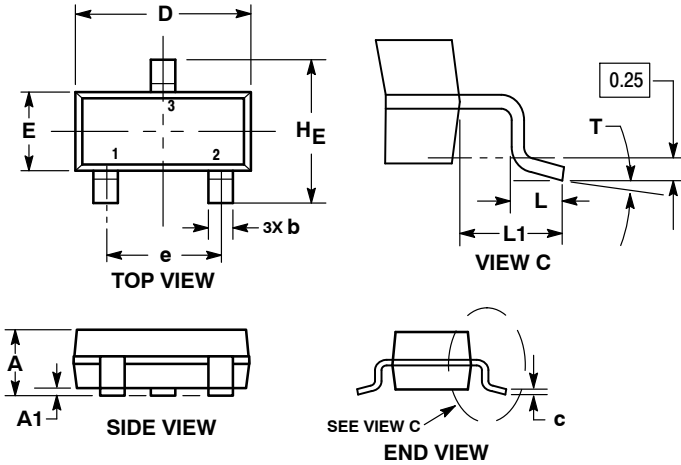

**NOTES:**

1. DIMENSIONING AND TOLERANCING PER ASME Y14.5M, 1994.
2. CONTROLLING DIMENSION: MILLIMETERS.
3. MAXIMUM LEAD THICKNESS INCLUDES LEAD FINISH. MINIMUM LEAD THICKNESS IS THE MINIMUM THICKNESS OF THE BASE MATERIAL.
4. DIMENSIONS D AND E DO NOT INCLUDE MOLD FLASH, PROTRUSIONS, OR GATE BURRS.

DIM	MILLIMETERS			INCHES		
	MIN	NOM	MAX	MIN	NOM	MAX
A	0.89	1.00	1.11	0.035	0.039	0.044
A1	0.01	0.06	0.10	0.000	0.002	0.004
b	0.37	0.44	0.50	0.015	0.017	0.020
c	0.08	0.14	0.20	0.003	0.006	0.008
D	2.80	2.90	3.04	0.110	0.114	0.120
E	1.20	1.30	1.40	0.047	0.051	0.055
e	1.78	1.90	2.04	0.070	0.075	0.080
L	0.30	0.43	0.55	0.012	0.017	0.022
L1	0.35	0.54	0.69	0.014	0.021	0.027
HE	2.10	2.40	2.64	0.083	0.094	0.104
T	0°	---	10°	0°	---	10°

**RECOMMENDED SOLDERING FOOTPRINT**

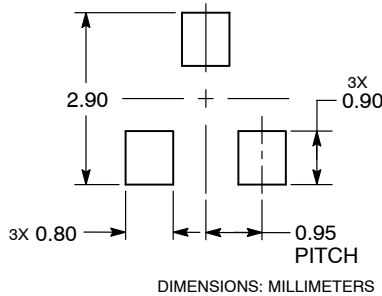

**GENERIC MARKING DIAGRAM\***

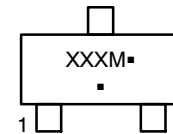

XXX = Specific Device Code  
M = Date Code  
▪ = Pb-Free Package

\*This information is generic. Please refer to device data sheet for actual part marking. Pb-Free indicator, "G" or microdot "▪", may or may not be present.

STYLE 1 THRU 5:  
CANCELLED

STYLE 6:  
PIN 1. BASE  
2. EMITTER  
3. COLLECTOR

STYLE 7:  
PIN 1. EMITTER  
2. BASE  
3. COLLECTOR

STYLE 8:  
PIN 1. ANODE  
2. NO CONNECTION  
3. CATHODE

STYLE 9:  
PIN 1. ANODE  
2. ANODE  
3. CATHODE

STYLE 10:  
PIN 1. DRAIN  
2. SOURCE  
3. GATE

STYLE 11:  
PIN 1. ANODE  
2. CATHODE  
3. CATHODE-ANODE

STYLE 12:  
PIN 1. CATHODE  
2. CATHODE  
3. ANODE

STYLE 13:  
PIN 1. SOURCE  
2. DRAIN  
3. GATE

STYLE 14:  
PIN 1. CATHODE  
2. GATE  
3. ANODE

STYLE 15:  
PIN 1. GATE  
2. CATHODE  
3. ANODE

STYLE 16:  
PIN 1. ANODE  
2. CATHODE  
3. CATHODE

STYLE 17:  
PIN 1. NO CONNECTION  
2. ANODE  
3. CATHODE

STYLE 18:  
PIN 1. NO CONNECTION  
2. CATHODE  
3. ANODE

STYLE 19:  
PIN 1. CATHODE  
2. ANODE  
3. CATHODE-ANODE

STYLE 20:  
PIN 1. CATHODE  
2. ANODE  
3. GATE

STYLE 21:  
PIN 1. GATE  
2. SOURCE  
3. DRAIN

STYLE 22:  
PIN 1. RETURN  
2. OUTPUT  
3. INPUT

STYLE 23:  
PIN 1. ANODE  
2. ANODE  
3. CATHODE

STYLE 24:  
PIN 1. GATE  
2. DRAIN  
3. SOURCE

STYLE 25:  
PIN 1. ANODE  
2. CATHODE  
3. GATE

STYLE 26:  
PIN 1. CATHODE  
2. ANODE  
3. NO CONNECTION

STYLE 27:  
PIN 1. CATHODE  
2. CATHODE  
3. CATHODE

STYLE 28:  
PIN 1. ANODE  
2. ANODE  
3. ANODE

<b>DOCUMENT NUMBER:</b>	<b>98ASB42226B</b>	Electronic versions are uncontrolled except when accessed directly from the Document Repository. Printed versions are uncontrolled except when stamped "CONTROLLED COPY" in red.
<b>DESCRIPTION:</b>	<b>SOT-23 (TO-236)</b>	<b>PAGE 1 OF 1</b>

ON Semiconductor and ON are trademarks of Semiconductor Components Industries, LLC dba ON Semiconductor or its subsidiaries in the United States and/or other countries. ON Semiconductor reserves the right to make changes without further notice to any products herein. ON Semiconductor makes no warranty, representation or guarantee regarding the suitability of its products for any particular purpose, nor does ON Semiconductor assume any liability arising out of the application or use of any product or circuit, and specifically disclaims any and all liability, including without limitation special, consequential or incidental damages. ON Semiconductor does not convey any license under its patent rights nor the rights of others.

**onsemi**, **Onsemi**, and other names, marks, and brands are registered and/or common law trademarks of Semiconductor Components Industries, LLC dba "**onsemi**" or its affiliates and/or subsidiaries in the United States and/or other countries. **onsemi** owns the rights to a number of patents, trademarks, copyrights, trade secrets, and other intellectual property. A listing of **onsemi**'s product/patent coverage may be accessed at [www.onsemi.com/site/pdf/Patent-Marking.pdf](http://www.onsemi.com/site/pdf/Patent-Marking.pdf). **onsemi** reserves the right to make changes at any time to any products or information herein, without notice. The information herein is provided "as-is" and **onsemi** makes no warranty, representation or guarantee regarding the accuracy of the information, product features, availability, functionality, or suitability of its products for any particular purpose, nor does **onsemi** assume any liability arising out of the application or use of any product or circuit, and specifically disclaims any and all liability, including without limitation special, consequential or incidental damages. Buyer is responsible for its products and applications using **onsemi** products, including compliance with all laws, regulations and safety requirements or standards, regardless of any support or applications information provided by **onsemi**. "Typical" parameters which may be provided in **onsemi** data sheets and/or specifications can and do vary in different applications and actual performance may vary over time. All operating parameters, including "Typicals" must be validated for each customer application by customer's technical experts. **onsemi** does not convey any license under any of its intellectual property rights nor the rights of others. **onsemi** products are not designed, intended, or authorized for use as a critical component in life support systems or any FDA Class 3 medical devices or medical devices with a same or similar classification in a foreign jurisdiction or any devices intended for implantation in the human body. Should Buyer purchase or use **onsemi** products for any such unintended or unauthorized application, Buyer shall indemnify and hold **onsemi** and its officers, employees, subsidiaries, affiliates, and distributors harmless against all claims, costs, damages, and expenses, and reasonable attorney fees arising out of, directly or indirectly, any claim of personal injury or death associated with such unintended or unauthorized use, even if such claim alleges that **onsemi** was negligent regarding the design or manufacture of the part. **onsemi** is an Equal Opportunity/Affirmative Action Employer. This literature is subject to all applicable copyright laws and is not for resale in any manner.

## PUBLICATION ORDERING INFORMATION

### LITERATURE FULFILLMENT:

Email Requests to: [orderlit@onsemi.com](mailto:orderlit@onsemi.com)

**onsemi Website:** [www.onsemi.com](http://www.onsemi.com)

### TECHNICAL SUPPORT

**North American Technical Support:**

Voice Mail: 1 800-282-9855 Toll Free USA/Canada

Phone: 011 421 33 790 2910

**Europe, Middle East and Africa Technical Support:**

Phone: 00421 33 790 2910

For additional information, please contact your local Sales Representative



# Mouser Electronics

Authorized Distributor

Click to View Pricing, Inventory, Delivery & Lifecycle Information:

[onsemi:](#)

[SZNUP2105LT1G](#) [SZNUP2105LT3G](#) [NUP2105LT1](#) [NUP2105LT1G](#)