

FOC-FDX20-PP-LCQ6-OM2-PT9 - Splice box



1019709

<https://www.phoenixcontact.com/us/products/1019709>

Please be informed that the data shown in this PDF document is generated from our online catalog. Please find the complete data in the user documentation. Our general terms of use for downloads are valid.



Splice box, design: Rail-mountable module, degree of protection: IP20, material: Metal, connection method: Splicing, cable outlet: above and below, housing size: 1, color: gray, Ethernet

Product description

FDX 20 series DIN rail splice box, assembled with 6x LC quad coupling, fully assembled and ready for splicing with pre-assembled 900 µm pigtails (OM2) and splice holder for separately available shrink and crimp splicing protection, on a patented splice comb made from powder-coated sheet steel. Cable insertion possible via cable gland from above or below. Housing, 2-part, prepared for DIN rail mounting through the rear-side adapter. The adapter can also be mounted on the side.

Scope of supply:

DIN rail housing with integrated splice comb (mounted), assembled with 6x LC quad coupling, 24x pigtail (OM2), 2x splice holder, 1x cable gland (M20x1.5)

Your advantages

- Intuitive front-panel operation and clear control cabinet layout thanks to uniform design
- Flexible DIN rail mounting possible in six positioning directions
- Suitable for industrial applications
- Reduced installation time with plug-and-play
- Pin assignment straight in line in a link
- Continuously reliable data connection, thanks to extensively tested components
- Snap-on mounting on standard DIN rails NS 35/7.5 or NS 35/15
- Transmission rate up to 1000 Mbps

Commercial data

| | |
|--------------------------------------|---------------------|
| Item number | 1019709 |
| Packing unit | 1 pc |
| Minimum order quantity | 1 pc |
| Sales key | AB15 |
| Product key | ABNGAA |
| Catalog page | Page 381 (C-2-2019) |
| GTIN | 4055626701059 |
| Weight per piece (including packing) | 765.1 g |
| Weight per piece (excluding packing) | 577 g |
| Customs tariff number | 85367000 |
| Country of origin | DE |

FOC-FDX20-PP-LCQ6-OM2-PT9 - Splice box



1019709

<https://www.phoenixcontact.com/us/products/1019709>

Technical data

Notes

| | |
|--------------------|--|
| Order information: | In addition, shrink splice protection (Item No.: 1019676) or crimp splice protection (Item No.: 1019678) must be ordered separately. |
|--------------------|--|

Product properties

| | |
|------------------------------|-------------------------|
| Product type | Network distributor box |
| Housing type | DIN rail adapter |
| Series | FDX 20 series |
| Type | Rail-mountable module |
| Sensor type | Ethernet |
| Connection profile | LC-Duplex |
| No. of cable outlets | 2 |
| No. of conductors | 24 |
| Number of module slots | 12 |
| Number of slots | 24 |
| Type of the screw connection | M20 x 1.5 |
| Protective cover | yes |
| Cable outlet | above and below |

Electrical properties

| | |
|---------------------|----------|
| Attenuation | ≤ 0.3 dB |
| Transmission medium | FO |

Connection data

| | |
|-----------------------|----------|
| Connection technology | |
| Connection method | Splicing |

Dimensions

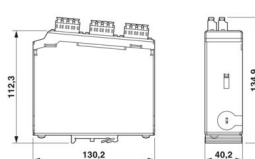
| | |
|---------------------|--|
| Dimensional drawing |  |
| Width | 40 mm |
| Height | 130 mm |
| Depth | 115 mm |

Housing

| | |
|---------------|-------|
| Housing width | 40 mm |
|---------------|-------|

Mechanical characteristics

FOC-FDX20-PP-LCQ6-OM2-PT9 - Splice box



1019709

<https://www.phoenixcontact.com/us/products/1019709>

| | |
|------------------|---------|
| Ferrule diameter | 1.25 mm |
|------------------|---------|

Material specifications

| | |
|--|---------------------|
| Color | gray |
| Flammability rating according to UL 94 | V0 |
| Ferrule material | Zirconia ceramics |
| Housing material | Metal |
| Housing surface material | Powder-coated, gray |

Cable/line

| | |
|--------------------------------|---|
| Cable type | Multimode fiberglass |
| Cable type | 900 µm |
| Cable structure | semi-loose compact wires (STB) |
| External cable diameter | 6 mm ... 12 mm |
| External cable diameter | 6 mm ... 12 mm |
| Wire diameter incl. insulation | 900 µm |
| Individual wire diameter | 900 µm (250/900 µm) |
| Single wire, color | Assignment color-coded in accordance with IEC 60794-2 |
| Halogen-free | yes |
| Flame resistance | yes |

FO cable

| | |
|---------------------|---------------------------------|
| Number of fibers | 24 |
| Fiber | GOF |
| Fiber type | Multi-mode 50/125 µm fiberglass |
| Attenuation | ≤ 0.3 dB (at 850 nm / 1300 nm) |
| Return Loss | ≥ 35 dB (at 850 nm / 1300 nm) |
| Transmission medium | FO |

Mechanical properties

Mechanical data

| | |
|------------------------------|-----------|
| Type of the screw connection | M20 x 1.5 |
| Insertion/withdrawal cycles | ≥ 500 |

Characteristics

| | |
|-------------|----------|
| Attenuation | ≤ 0.3 dB |
|-------------|----------|

Environmental and real-life conditions

Ambient conditions

| | |
|---|---------------------------------------|
| Degree of protection | IP20 (according to IEC 60529) IP20 |
| Ambient temperature (operation) | -25 °C ... 70 °C |
| Ambient temperature (storage/transport) | -40 °C ... 85 °C |
| Ambient temperature (assembly) | 0 °C ... 50 °C |

FOC-FDX20-PP-LCQ6-OM2-PT9 - Splice box



1019709

<https://www.phoenixcontact.com/us/products/1019709>

| | |
|----------------------------|-----|
| Resistance to UV radiation | yes |
|----------------------------|-----|

Standards and regulations

| | |
|------------------|-----|
| Flame resistance | yes |
|------------------|-----|

Mounting

| | |
|-----------------------|--|
| Mounting type | DIN rail mounting |
| Assembly instructions | Option for flexible replugging of DIN rail adapter |

FOC-FDX20-PP-LCQ6-OM2-PT9 - Splice box



1019709

<https://www.phoenixcontact.com/us/products/1019709>

Drawings

Dimensional drawing

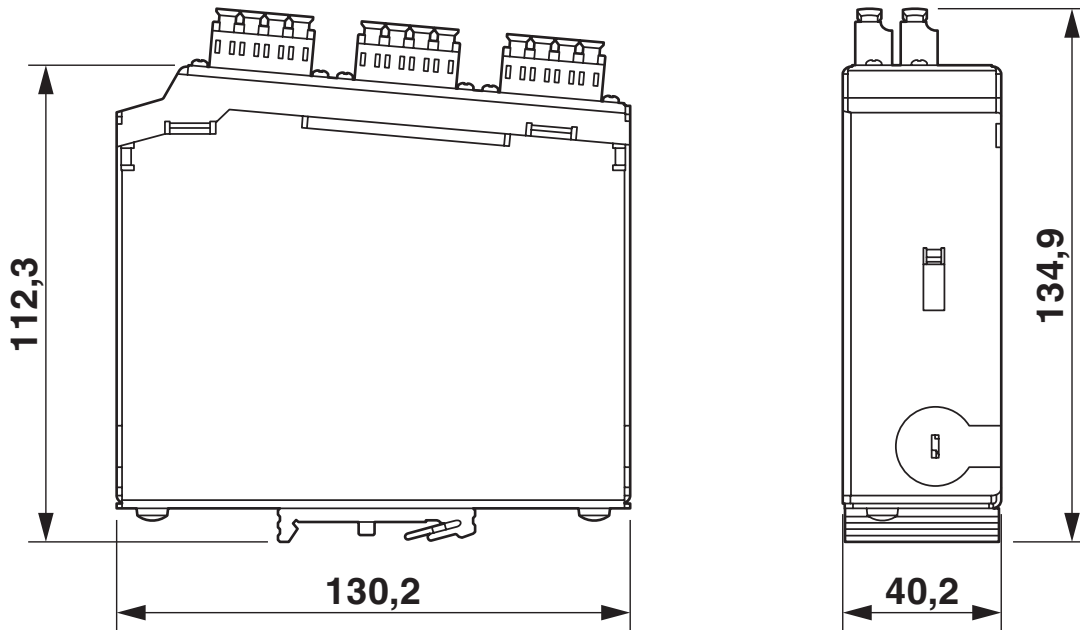

DIN rail splice box 6x LC quad OM2, fully mounted ready to splice

1019709

<https://www.phoenixcontact.com/us/products/1019709>

Classifications

ECLASS

| | |
|-------------|----------|
| ECLASS-11.0 | 19170113 |
| ECLASS-12.0 | 19170113 |
| ECLASS-13.0 | 19170113 |

ETIM

| | |
|----------|----------|
| ETIM 9.0 | EC002699 |
|----------|----------|

UNSPSC

| | |
|-------------|----------|
| UNSPSC 21.0 | 43223300 |
|-------------|----------|

1019709

<https://www.phoenixcontact.com/us/products/1019709>

Environmental product compliance

EU RoHS

| | |
|---|--------------------|
| Fulfills EU RoHS substance requirements | Yes, No exemptions |
|---|--------------------|

China RoHS

| | |
|--|--|
| Environment friendly use period (EFUP) | EFUP-E |
| | No hazardous substances above the limits |

EU REACH SVHC

| | |
|-------------------------------------|----------------------------|
| REACH candidate substance (CAS No.) | No substance above 0.1 wt% |
|-------------------------------------|----------------------------|

FOC-FDX20-PP-LCQ6-OM2-PT9 - Splice box



1019709

<https://www.phoenixcontact.com/us/products/1019709>

Mandatory accessories

FOC-SHRINKSPLICE-PROTECT - Shrink splice protection

1019676

<https://www.phoenixcontact.com/us/products/1019676>



Shrink splice protection, design: Straight, degree of protection: IP20, cable outlet: above and below, color: transparent

FOC-CRIMPSPLICE-PROTECT - Crimp splice protection

1019678

<https://www.phoenixcontact.com/us/products/1019678>



Crimp splice protection, design: Straight, degree of protection: IP20, connection method: Crimp connection, cable outlet: above and below, color: Bare metallic

Accessories

FOC-FDX20-PP-LCQ6-OM2-PT9 - Splice box



1019709

<https://www.phoenixcontact.com/us/products/1019709>

FOC-LC:PA-LC:PA-OM2:D01/1 - FO patch cable

1115633

<https://www.phoenixcontact.com/us/products/1115633>

Multi-mode OM2 duplex jumper, LC-LC, UPC polishing, length 1 m

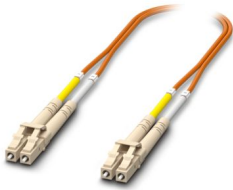

FOC-LC:PA-ST:PA-OM2:D01/1 - Fiber optic cable

1115588

<https://www.phoenixcontact.com/us/products/1115588>

Multi-mode OM2 duplex jumper, LC-ST, UPC polishing, length 1 m

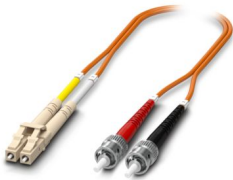

FOC-FDX20-PP-LCQ6-OM2-PT9 - Splice box



1019709

<https://www.phoenixcontact.com/us/products/1019709>

FOC-LC:PA-SC:PA-OM2:D01/1 - FO patch cable

1115607

<https://www.phoenixcontact.com/us/products/1115607>

Multi-mode OM2 duplex jumper, LC-SC, UPC polishing, length 1 m

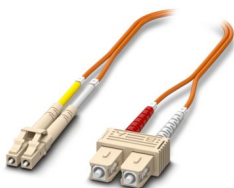

FOC-LC:PA-LC:PA-OM2:D01/2 - FO patch cable

1115634

<https://www.phoenixcontact.com/us/products/1115634>

Multi-mode OM2 duplex jumper, LC-LC, UPC polishing, length 2 m

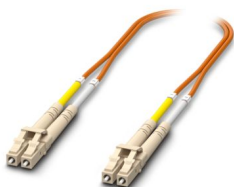

FOC-FDX20-PP-LCQ6-OM2-PT9 - Splice box



1019709

<https://www.phoenixcontact.com/us/products/1019709>

FOC-LC:PA-ST:PA-OM2:D01/2 - Fiber optic cable

1115587

<https://www.phoenixcontact.com/us/products/1115587>

Multi-mode OM2 duplex jumper, LC-ST, UPC polishing, length 2 m

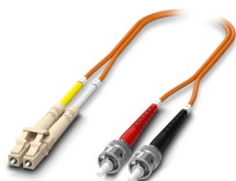

FOC-LC:PA-SC:PA-OM2:D01/2 - FO patch cable

1115605

<https://www.phoenixcontact.com/us/products/1115605>

Multi-mode OM2 duplex jumper, LC-SC, UPC polishing, length 2 m

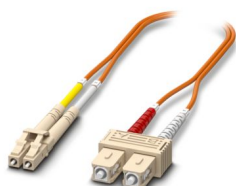

FOC-FDX20-PP-LCQ6-OM2-PT9 - Splice box



1019709

<https://www.phoenixcontact.com/us/products/1019709>

FOC-LC:PA-LC:PA-OM2:D01/5 - FO patch cable

1115637

<https://www.phoenixcontact.com/us/products/1115637>

Multi-mode OM2 duplex jumper, LC-LC, UPC polishing, length 5 m

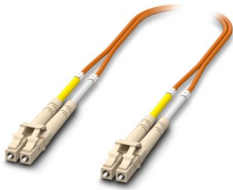

FOC-LC:PA-ST:PA-OM2:D01/5 - FO patch cable

1115584

<https://www.phoenixcontact.com/us/products/1115584>

Multi-mode OM2 duplex jumper, LC-ST, UPC polishing, length 5 m

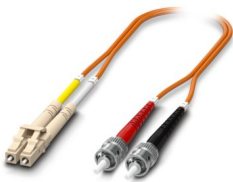

FOC-FDX20-PP-LCQ6-OM2-PT9 - Splice box



1019709

<https://www.phoenixcontact.com/us/products/1019709>

FOC-LC:PA-SC:PA-OM2:D01/5 - FO patch cable

1115603

<https://www.phoenixcontact.com/us/products/1115603>

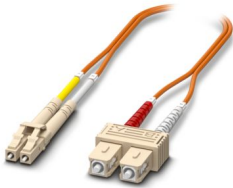

FO patch cable, degree of protection: IP20, cable length: 5 m, number of positions: 2, 1 Gbps, OM2

FOC-OE-OE-GL-U-OM2-24/... - FO cable

1286215

<https://www.phoenixcontact.com/us/products/1286215>



GOF universal cable, 24-wire, loose tube cable for fixed installation, non-metallic rodent protection, can be easily stripped, UV-resistant, high mechanical and thermal stability, low smoke, halogen-free and self-extinguishing, improved tread resistance, longitudinally and transversely watertight

FOC-FDX20-PP-LCQ6-OM2-PT9 - Splice box



1019709

<https://www.phoenixcontact.com/us/products/1019709>

FOC-LC:A-LC:A-GZ01/... - FO patch cable

1405688

<https://www.phoenixcontact.com/us/products/1405688>

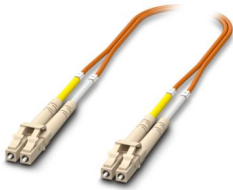

Assembled FO cable, zip cord cable, multi-mode fiberglass 50/125 μm , OM2, plug: LC/LC, degree of protection: IP20, for installation in cable ducts or control cabinets

FOC-ST:A-LC:A-GZ01/... - FO patch cable

1405706

<https://www.phoenixcontact.com/us/products/1405706>

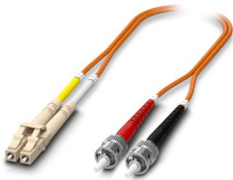

Assembled FO cable, zip cord cable, multi-mode fiberglass 50/125 μm , OM2, plug: B-FOC (ST)/LC, degree of protection: IP20, for installation in cable ducts or control cabinets

FOC-FDX20-PP-LCQ6-OM2-PT9 - Splice box



1019709

<https://www.phoenixcontact.com/us/products/1019709>

FOC-SC:A-LC:A-GZ01/... - FO patch cable

1405691

<https://www.phoenixcontact.com/us/products/1405691>

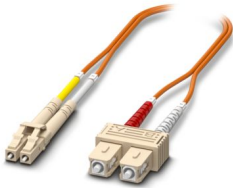

Assembled FO cable, zip cord cable, multi-mode fiberglass 50/125 μm , OM2, plug: SC duplex/LC, degree of protection: IP20, for installation in cable ducts or control cabinets

FOC-LC:A-SJ:A-GZ01/... - FO patch cable

1405694

<https://www.phoenixcontact.com/us/products/1405694>



Assembled FO cable, zip cord cable, multi-mode fiberglass 50/125 μm , OM2, plug: LC/SC-RJ, degree of protection: IP20, for installation in cable ducts or control cabinets

FOC-FDX20-PP-LCQ6-OM2-PT9 - Splice box



1019709

<https://www.phoenixcontact.com/us/products/1019709>

FOC-TOOL-FERRULECLEANER-1.25 - FO accessories

1407032

<https://www.phoenixcontact.com/us/products/1407032>

Ferrule cleaner, 1.25 mm, for LC, approx. 500 cleaning cycles



FOC-TOOL-STICKCLEANER-1.25 - FO accessories

1407000

<https://www.phoenixcontact.com/us/products/1407000>

Stick cleaner for couplings and plug end faces, 1.25 mm (LC), Pcs. / Pkt.: 10



FOC-FDX20-PP-LCQ6-OM2-PT9 - Splice box



1019709

<https://www.phoenixcontact.com/us/products/1019709>

A-INSP-M20-68N-P-LG - Screw plug

1424519

<https://www.phoenixcontact.com/us/products/1424519>

Screw plug, material for screw connection: PA, connecting thread: M20 x 1.5, color: lightgrey RAL 7035, with O-ring



WP-CN PA M20 - Counter nut

3241134

<https://www.phoenixcontact.com/us/products/3241134>

Counter nut, for threads M20, color: gray



FOC-FDX20-PP-LCQ6-OM2-PT9 - Splice box



1019709

<https://www.phoenixcontact.com/us/products/1019709>

SF-PH 1-80 - Screwdriver

1212559

<https://www.phoenixcontact.com/us/products/1212559>



Screwdriver, PH crosshead (lasered), uninsulated, size: PH 1 x 80, 2-component grip, with non-slip grip

SF-SL 1,0X5,5-150 - Screwdriver

1212552

<https://www.phoenixcontact.com/us/products/1212552>



Screwdriver, bladed (lasered), size: 1.0 x 5.5 x 150 mm, 2-component grip, with non-slip grip

FOC-FDX20-PP-LCQ6-OM2-PT9 - Splice box



1019709

<https://www.phoenixcontact.com/us/products/1019709>

E/NS 35 N - End bracket

0800886

<https://www.phoenixcontact.com/us/products/0800886>

End clamp, width: 9.5 mm, color: gray

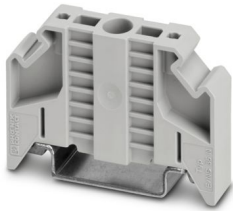

NBC-PP-G1PGY - DIN rail adapter

1041740

<https://www.phoenixcontact.com/us/products/1041740>

DIN rail adapter, design: Headers with shielding, degree of protection: IP20, material: PC-GF10, connection method: Quick connection, without assembled modules



FOC-FDX20-PP-LCQ6-OM2-PT9 - Splice box



1019709

<https://www.phoenixcontact.com/us/products/1019709>

FL DIN RA - DIN rail adapter

2891053

<https://www.phoenixcontact.com/us/products/2891053>

The FL DIN RA is installed in a standard, 19-inch rack (EIA-310-D, IEC 60297-3-100) to allow DIN rail mounted equipment to be rack mounted.



G-INS-M20-S68N-PNES-GY - Cable gland

1411125

<https://www.phoenixcontact.com/us/products/1411125>

Cable gland, material for screw connection: PA, application: Standard, external cable diameter 6 mm ... 12 mm, shielding: no, connecting thread: M20 x 1.5, color: silver-grey RAL 7001



1019709

<https://www.phoenixcontact.com/us/products/1019709>

TML (104X10)R - Marker strip

0801835

<https://www.phoenixcontact.com/us/products/0801835>



Marker strip, Roll, white, unlabeled, can be labeled with: THERMOMARK E.300 (D)/600 (D), THERMOMARK ROLL 2.0, THERMOMARK ROLL, THERMOMARK ROLL X1, THERMOMARK ROLLMASTER 300/600, THERMOMARK X1.2, mounting type: adhesive, for terminal block width: 104 mm, lettering field size: 104 x 10 mm, Number of individual labels: 1500

TML (EX9,5)R TR - Marker strip

0816634

<https://www.phoenixcontact.com/us/products/0816634>



Marker strip, Roll, transparent, unlabeled, can be labeled with: THERMOMARK E.300 (D)/600 (D), THERMOMARK ROLL 2.0, THERMOMARK ROLL, THERMOMARK ROLL X1, THERMOMARK ROLLMASTER 300/600, THERMOMARK X1.2, mounting type: adhesive, for terminal block width: 30000 mm, lettering field size: 40000 x 9.5 mm, Number of individual labels: 1

FOC-FDX20-PP-LCQ6-OM2-PT9 - Splice box



1019709

<https://www.phoenixcontact.com/us/products/1019709>

EMLS (70X32)R SR - Safety label with special adhesive

0800346

<https://www.phoenixcontact.com/us/products/0800346>



Safety label with special adhesive, Roll, silver, unlabeled, can be labeled with: THERMOMARK E.300 (D)/600 (D), THERMOMARK ROLL 2.0, THERMOMARK ROLL, THERMOMARK ROLL X1, THERMOMARK ROLLMASTER 300/600, THERMOMARK X1.2, mounting type: adhesive, lettering field size: 70 x 32 mm, Number of individual labels: 500

EML-HA (76X51)R - Label for rough surfaces

0830609

<https://www.phoenixcontact.com/us/products/0830609>



Label for rough surfaces, Roll, white, unlabeled, can be labeled with: THERMOMARK E.300 (D)/600 (D), THERMOMARK ROLL 2.0, THERMOMARK ROLL, THERMOMARK ROLL X1, THERMOMARK ROLLMASTER 300/600, THERMOMARK X1.2, mounting type: adhesive, lettering field size: 76 x 51 mm, Number of individual labels: 1000

FOC-FDX20-PP-LCQ6-OM2-PT9 - Splice box



1019709

<https://www.phoenixcontact.com/us/products/1019709>

PML-W100 (25X25)R - Warning label

0830429

<https://www.phoenixcontact.com/us/products/0830429>

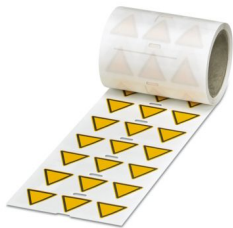

Warning label, Roll, yellow/black, unlabeled, can be labeled with: THERMOMARK E.300 (D)/600 (D), THERMOMARK ROLL 2.0, THERMOMARK ROLL, THERMOMARK ROLL X1, THERMOMARK ROLLMASTER 300/600, THERMOMARK X1.2, mounting type: adhesive, diameter: 0 mm, lettering field size: 25 x 25 mm, Number of individual labels: 500

LS-EMLP (60X15) WH - Device marker

0831696

<https://www.phoenixcontact.com/us/products/0831696>



Device marker, Sheet, white, unlabeled, can be labeled with: TOPMARK NEO, TOPMARK LASER, mounting type: adhesive, lettering field size: 60 x 15 mm, Number of individual labels: 20

FOC-FDX20-PP-LCQ6-OM2-PT9 - Splice box



1019709

<https://www.phoenixcontact.com/us/products/1019709>

WML-RFID/HF 14 (25X19)R - Cable marker

0803386

<https://www.phoenixcontact.com/us/products/0803386>



Cable marker label with RFID-HF transponder, roll, white, unmarked, can be printed with: THERMOMARK ROLL, THERMOMARK ROLL X1, THERMOMARK X1.2, mounting type: adhesive, min. cable diameter: 9 mm, max. cable diameter: 14 mm, lettering field size: 25 x 19 mm

Phoenix Contact 2024 © - all rights reserved

<https://www.phoenixcontact.com>

Phoenix Contact USA
586 Fulling Mill Road
Middletown, PA 17057, United States
(+717) 944-1300
info@phoenixcon.com