

# IPA/CPA SERIES

## MAGNETIC CIRCUIT PROTECTORS

### Introduction

The Airpax™ IPA/CPA hydraulic-magnetic circuit protectors provide low-cost power switching, reliable circuit protection and accurate circuit control for equipment in the international marketplace.

IPA models meet IEC spacing requirements that are mandatory for equipment which must comply with IEC specifications 601 and 950 and VDE specifications 0804 and 0805. In addition, they are UL Recognized as supplementary protectors per UL STD.

1077, CSA Certified as supplementary protectors per CSA C 22.2- No. 235, TUV Approved to VDE 0642 (EN60934), CCC Approved (pending) and CE Compliant.



Designed using the latest in sensitive hydraulic magnetic technology, the IPA line adapts itself to many applications and environments. They're ideal for data processing and business machines, medical instrumentation, broadcast equipment, vending and amusement machines, military applications and wherever precision operation is required. Temperature differences which affect fuses and other thermal devices are not a concern. One important feature of this protector line is a "trip free" action, which means the circuit will trip in the presence of an overload even though the handle is held in the ON position. The delay mechanism senses the fault and the contacts open.

The IPA is available in configurations including series and series with auxiliary switch, with a choice of delays and ratings in either DC, 50/60Hz or 400Hz versions. Single or multi-pole versions are available, with a variety of pole arrangements to meet your specifications.

### SPECIFICATIONS

#### Trip Free

Will trip open on overload, even when the handle is forcibly held on or restrained. This prevents operator from damaging the circuit by holding the handle in the ON position.

#### Trip Indication

The operating handle moves positively to the OFF position.

#### Ambient Operation

IPA protectors operate in temperatures between -40°C and +85°C.

#### Insulation Resistance

Not less than 100 megohms at 500 volts DC.

#### Dielectric Strength

IPA protectors withstand 3000Vac, 60Hz for 60 seconds between all electrically isolated terminals except auxiliary switch terminals shall withstand 500Vac, 60Hz for REG and REC types.

#### Endurance

Operating as a switch, the operating life exceeds 10,000 operations, at rated current, at a rate of 6 per minute.

#### Electrical Characteristics

IPA protectors are rated .050 to 30 amperes 65Vdc; .050 to 30 amperes 240 Vac 50/60Hz; 0.050 to 15 amperes 250Vac, 400Hz.

#### Poles

One through three poles available.

## Construction

Series and series with auxiliary switch available in various delays and combinations.

## Auxiliary and Alarm Switch

When supplied shall be S.P.D.T. configuration with a maximum rating of 3.0 amperes, 250Vac resistive load. Gold contacts are rated at .100 amperes, 125Vac resistive load.

## Moisture Resistance

Meet all the requirements of MIL-PRF-55629 when tested in accordance with Method 106 of MIL-STD-202.

## Salt Spray (Corrosion)

Meet the requirements of MIL-PRF-55629 when tested in accordance with Method 101 of MIL-STD-202.

## Shock

Circuit protectors shall not trip when tested per MIL-STD-202, Method 213, Test Condition B with 100% rated current applied to delayed units and 80% rated current to instantaneous units. Units with auxiliary switches will withstand 30G max.

## Vibration

Circuit protectors shall not trip when vibrated per MIL-STD-202, Method 201, Test Condition A with 100% rated current applied to delayed units and 80% rated current to instantaneous units.

Recommended Torque Specifications	
Component	Torque (in-lbs)
6-32 Mounting Inserts	6 to 8
M3 Mounting Screws	4 to 5
M4 Terminal Screws	10 to 12

Where applicable, mechanical support must be provide to the terminals when applying torque

Approximate Weight Per Pole	
Ounces	Grams
1.7	48

Inrush Pulse Tolerance	
Delay	Pulse Tolerance
61, 62, 600	8 times rated current
61F, 62F, 600F	12 times rated current

Comparison of inrush pulse tolerance is with and without the inertia delay feature for each of the 50/60 Hz delays. Pulse tolerance is defined as a single pulse of half sine wave peak current amplitude of 8 milliseconds duration that will not trip the circuit protector

## SINGLE POLE (ONE HANDLE)

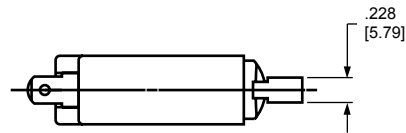
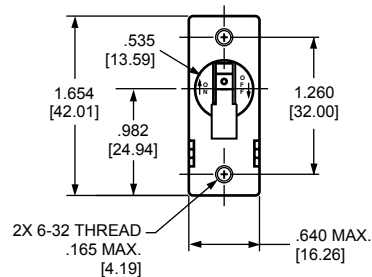
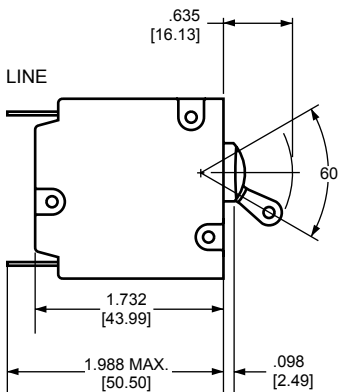

### Mounting Detail

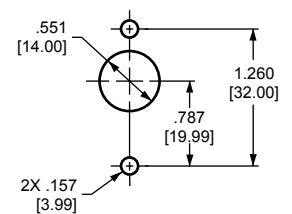

### Notes:

1. Tolerance  $\pm .015$  [.38] unless noted. Dimensions in brackets [ ] are millimeters.
2. Main circuit breaker terminals are stationary male push-on type: .248 [6.30] wide x .031 [.787] thick x .474 [12.00] long, or screw type: M4 x .354 [8.99] wide x .031 [.787] thick x .474 [12.00] long.



# MULTI-POLE CIRCUIT PROTECTORS

## Two Pole Protectors

An assembly consisting of two single pole units, having their trip mechanisms internally coupled and with a single toggle handle, forms the IPA-11 with quick-connect D.I.N.-style terminals.

Individual poles may differ in ratings, delays and internal connections. An auxiliary switch may be included in either or both poles, allowing you to mix SELV and hazardous voltages. Rugged screw-type terminals can be provided, in which case the designation would be IPA-66. The IPAH offers a toggle handle for each pole.

## Three Pole Protectors

The three pole construction consists of three single pole units assembled with an internal mechanical interlock which actuates all units simultaneously. A single toggle handle operates all three poles for quick and convenient control, or if preferred, a handle per pole is available. The individual poles need not have identical characteristics and any series trip pole may have an auxiliary switch. If screw-type terminals are required, the breaker designation will be IPA-666 for a three pole version.

Breaker poles are numbered consecutively when viewed from the terminal side, with the ON position up, starting with Pole #1 on the left side and proceeding to the right.

## Handles

The IPAH two and three pole models are available with a handle per pole.

Note: Tolerance  $\pm .015$  [.38]

unless noted. Dimensions in Brackets [ ] are millimeters.

### IPA/CPA

#### Two Pole Protectors (one handle)

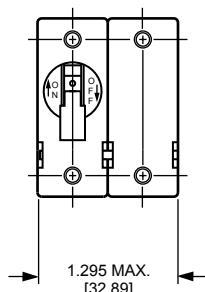

(Optional: Handle may be located in Pole 1 instead of Pole 2)

#### Three Pole Protectors (one handle)

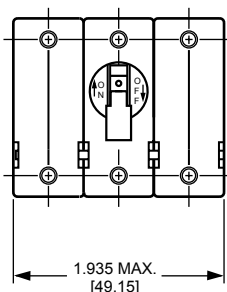

### Mounting Details

#### Two PoleT

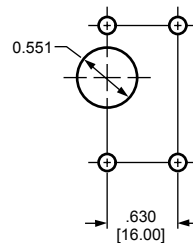

#### Three Pole

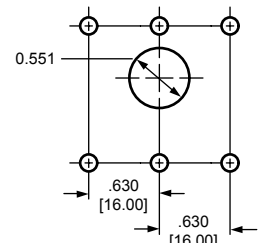

### IPA/CPA

#### Two Pole Protectors (one handle)

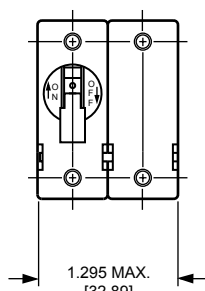

(Optional: Handle may be located in Pole 1 instead of Pole 2)

#### Three Pole Protectors (one handle)

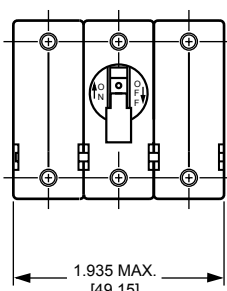

### Mounting Details

#### Two PoleT

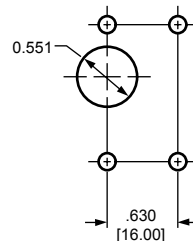

#### Three Pole

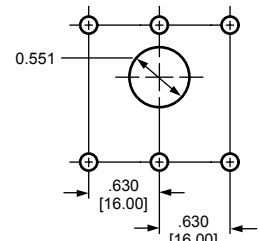



# PC (PRINTED CIRCUIT) BOARD MOUNTED CIRCUIT PROTECTORS

Note: Tolerance  $\pm .015$  [ .38]  
 unless noted. Dimensions in Brackets [ ] are millimeters.

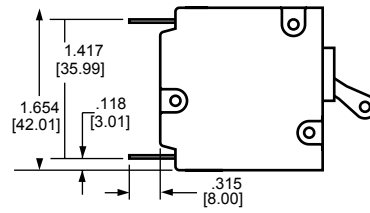

## Printed Circuit Board Mounting Terminal Type "S"

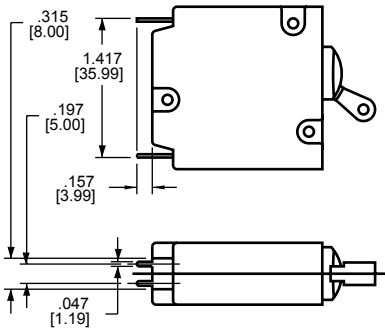

### Mounting Detail

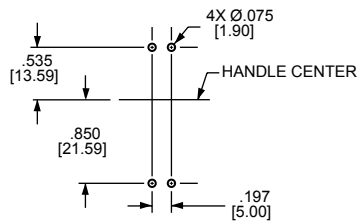

(Auxiliary switch is not recommended with this type mounting.)

## Printed Circuit Board Mounting Terminal Type "R"

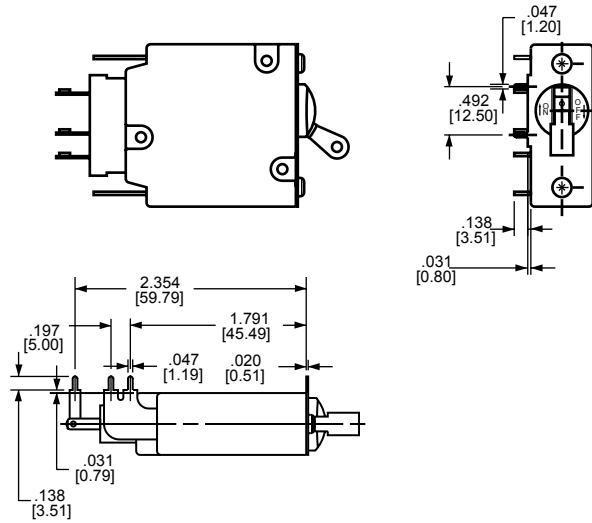

### Mounting Detail

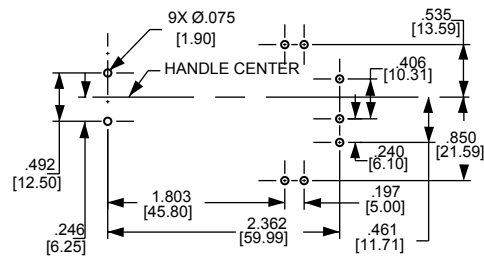

## Printed Circuit Board Mounting Terminal Type "L"

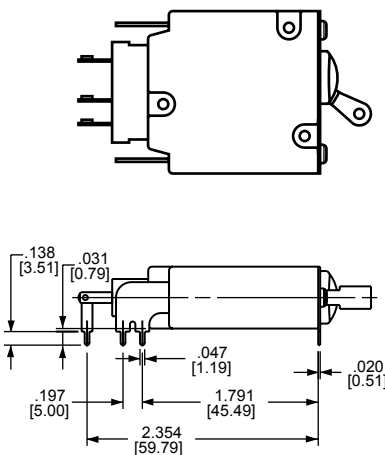

### Mounting Detail

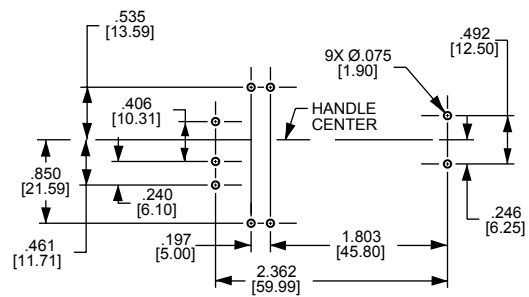



### Series Trip

The most popular configuration for magnetic protectors is the series trip where the sensing coil and contacts are in series with the load being protected. In addition to providing conventional overcurrent protection, the handle position conveniently indicates circuit status.

### Auxiliary Switch (Applies to Series Trip Only)

This is furnished as an integral part of a series pole in single or multi-pole assemblies. Isolated electrically from the protector's circuit, the switch works in unison with the power contacts and provides indication at a remote location of the protector's on-off status.

Auxiliary switch contacts actuate simultaneously with the main breaker contacts, and will open regardless of whether the breaker contacts are opened manually or electrically. For auxiliary switch ratings below 6Vac or 5Vdc, an auxiliary switch with gold contacts, designated as REG, is available. Gold contacts are not recommended for load current above 100 milliamps. An optional auxiliary switch, RS, configuration allows an alarm or signal to be forwarded only upon electrical overload, allowing for easier detection of fault circuit.

DCR and Impedance values are based on measurements by the voltmeter ammeter method. Rated current is applied for one hour and at a voltage not less than 20 volts. Ambient temperature: 25 C; Tolerance: Below 10 amps ± 25%; Above 10 amps ± 50%; \*Consult factory for special values and for coil impedance of delays not shown.

Current Ratings (Amps)	Typical Resistance/ Impedance		
	Series Type (Except delays 40, 50, 60)		
	DC (ohms)	AC, 50/60Hz (ohms)	AC, 400Hz (ohms)
0.050	427	478	-
0.100	100	103	204
0.250	19	20	34
0.500	4.6	6.3	8.2
0.750	2.04	2.06	3.52
1.00	0.91	0.92	1.86
2.50	0.17	0.19	0.28
5.00	0.045	0.046	0.073
7.50	0.018	0.019	0.037
10.0	0.013	0.014	0.020
15.0	0.0072	0.0073	0.019
20.0	0.005	0.0051	-
25.0	0.003	0.0035	-

#### Series Trip

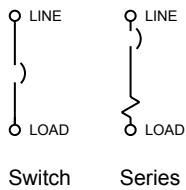
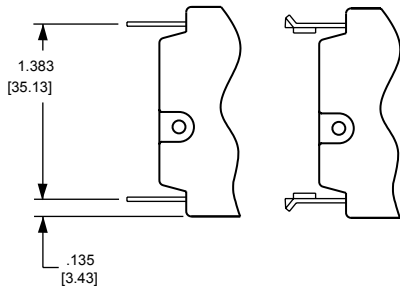

#### Series with Auxiliary Switch

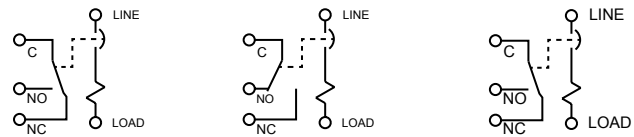
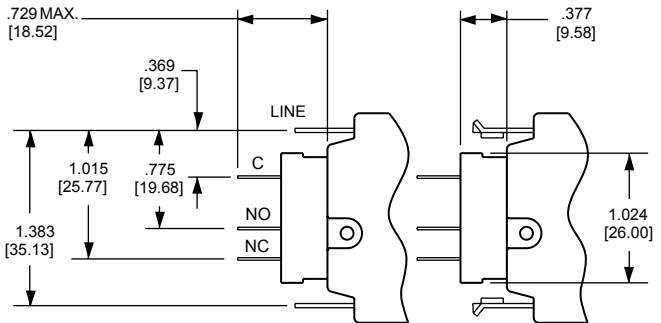

C-NC = Breaker in "OFF" position.

Breaker in "ON" or manually turned "OFF" position.

Breaker in electrically tripped "OFF" position.

Series with Auxiliary Switch

Auxiliary Alarm Switch (IRS4, IRSG4)

#### Notes:

1. Main circuit protector terminals are stationary male push-on type: .248 [6.30] wide x .031 [.787] thick x .474 [12.00] long, or screw type: M4 x .354 [8.99] wide x .031 [.787] thick x .474 [12.00] long.
2. Auxiliary switch terminals are: .110 [2.79] wide x .020 [0.51] thick x .343 [8.71] long.
3. Tolerance ± .015 [.38] unless noted. Dimensions in brackets [ ] are millimeters.

Percentage of Rated Current vs Trip Time in Seconds at +25°C (Vertical Mount)									
Frequency	Delay	100%	125%	150%	200%	400%	600%	800%	1000%
400 Hz	40	No Trip	May Trip	May Trip	090 Max	.060 Max	.050 Max	.040 Max	.035 Max
	41	No Trip	May Trip	.2 to 9	.09 to 3	02 to .6	.006 to .3	.003 to .2	.003 to .15
	42	No Trip	May Trip	3 to 80	1 to 25	.06 to 4	.01 to 1.5	.004 to .6	.003 to .3
	400	No Trip	May Trip	20 to 900	6 to 250	.2 to 45	.01 to 6	.003 to .9	.003 to .5
DC	51*	No Trip	.500 to 16	.3 to 5	.13 to 1.5	.03 to .2	.005 to .1	.003 to .05	.003 to .025
	52*	No Trip	7 to 100	3 to 40	.620 to 15	.12 to 2.5	.003 to .5	.003 to .05	.003 to .025
	59*	No Trip	.120 Max	.073 Max	.038 Max	.021 Max	.017 Max	.017 Max	.017 Max
	500	No Trip	70 to 800	25 to 300	10 to 100	1.2 to 20	.007 to 5	.004 to .65	.003 to .1
50/60 Hz	61	No Trip	.700 to 15	.3 to 4	.1 to 1.3	.02 to .25	.006 to .13	.003 to .07	.003 to .04
	62	No Trip	12 to 180	6 to 70	2 to 25	.15 to 3.5	.005 to .3	.004 to .13	.004 to .04
	69	No Trip	.120 Max	.073 Max	.038 Max	.021 Max	.017 Max	.017 Max	.017 Max
	600	No Trip	50 to 800	20 to 300	5.5 to 110	.3 to 17	.004 to .5	.004 to .5	.004 to .1

Notes: All trip times and trip currents are specified with the protector mounted in the normal vertical position at ambient temperature of 25 C. Breakers do not carry current prior to application of overload.  
 \*CPA type units are available only with 51, 52 and 59 delays.

## DELAY CURVES & SPECIFICATIONS

A choice of delays is offered for DC, 50/60Hz and 400Hz applications. Delays 40, 59 and 69 provide fast acting, instantaneous trip and are often used to protect sensitive electronic equipment (not recommended where a known inrush exists). Delays 41, 51 and 61 have a short delay for general purpose applications. Delays 42, 52 and 62 are long enough to start certain types of motors and most transformer and capacitor loads. Delays 400, 500 and 600 are long delays for special motor applications.

### DC Delay Curves (typ)

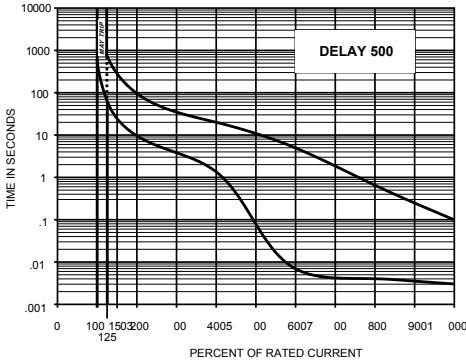
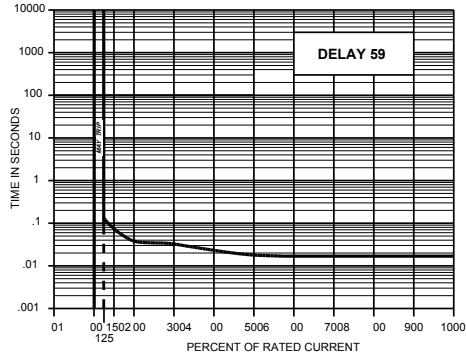
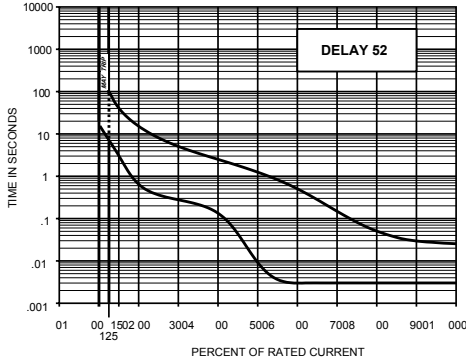
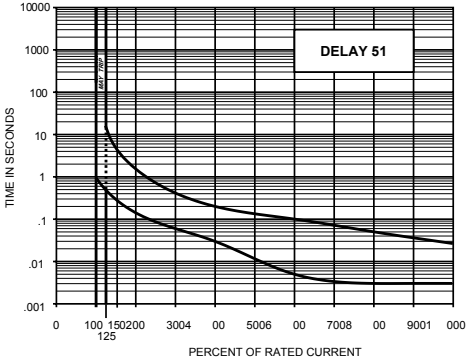

### 50/60Hz Delay Curves (typ)

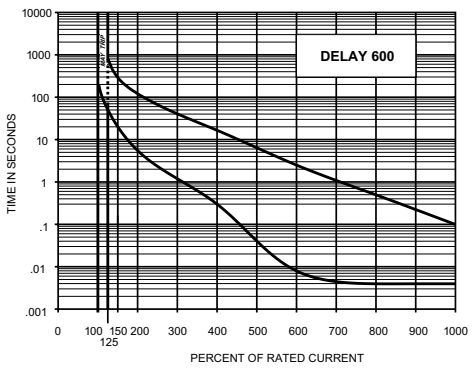
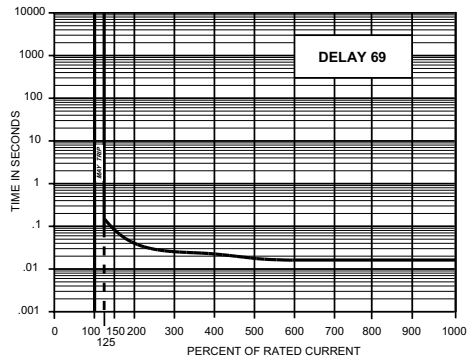
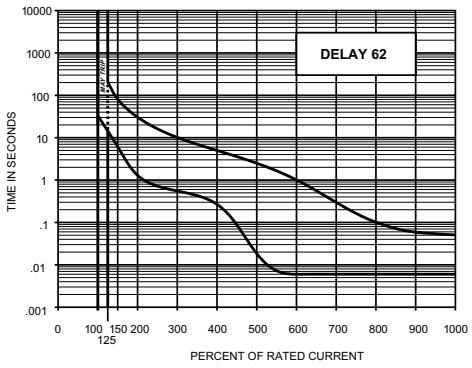
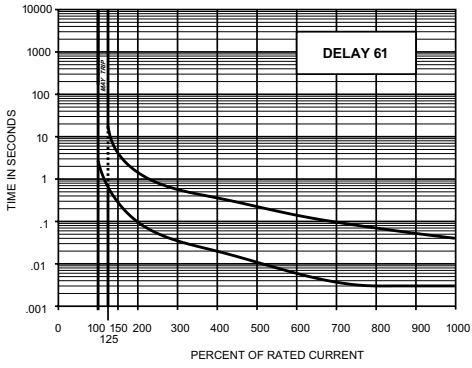

### 400Hz Delay Curves (typ)

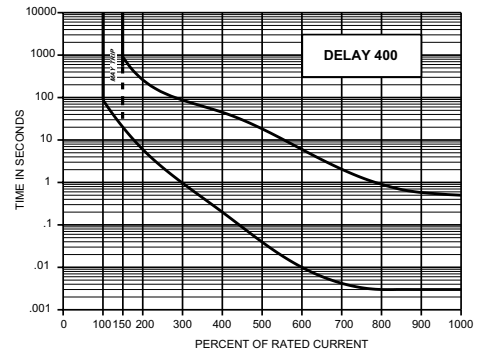
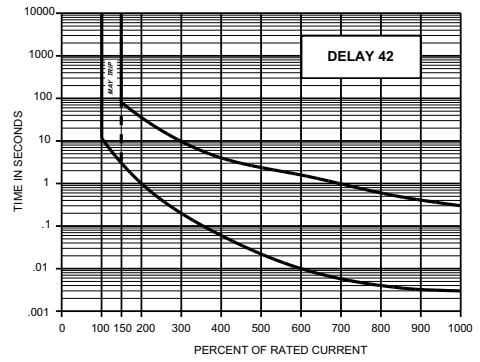
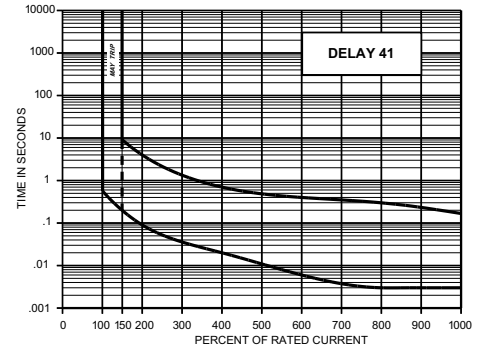
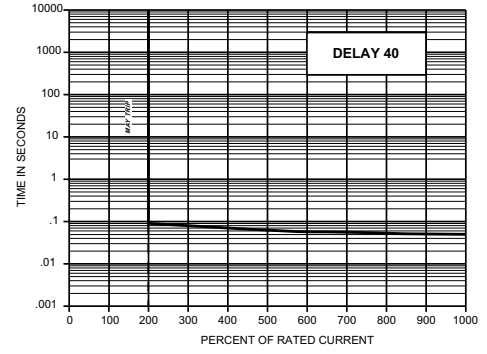



**IPAP - 1 - 1REC4 - 61 - 10.0 - L - 01 - T**

**Type**

**IPA:** One toggle handle per unit UL Recognized  
**IPAP:** One toggle handle per unit UL Recognized  
 PC board mount  
**IPAH:** One toggle handle per pole UL Recognized  
**IPAHP:** One toggle handle per pole UL Recognized  
 PC board mount  
**CPA:** One toggle handle per unit UL Listed per UL489A  
**CPAH:** One toggle handle per pole UL Listed per UL489A

**Poles**

**-1:** Single pole w/ quick connect terminals or PC board if P is used  
**-11:** Two pole w/ quick connect terminals or PC board if P is used.  
**-111:** Three pole w/ quick connect terminals or PC board if P is used.  
**-6:** Single pole w/ screw terminals  
**-66:** Two pole w/ screw terminals  
**-666:** Three pole w/ screw terminals

**Configuration**

**-0:** Switch only  
**-1:** Series  
**-1REC4:** Series with silver contact Auxiliary switch  
**-1REG4:** Series with gold contact Auxiliary switch  
**-1RS4:** Series with silver contact Alarm switch  
**-1RS4G:** Series with gold contact Alarm switch  
 Notes: 1. For switch type, eliminate 4th & 5th decision.  
 2. Switch will be marked with Max. current & voltage.  
 3. The alarm switch is located in the handle pole for single handle types and in pole 2 for units with a handle per pole. The auxiliary switch may be located in any pole. However the standard location is in pole 2.  
 4. Switch type with alarm switch must be multi-pole connected to a pole equipped with either an overcurrent or overvoltage mechanism.  
 (Consult factory for further information.)

**Frequency & Delay**

**SW:** Switch only  
**-40:** 400Hz instant trip  
**-41:** 400Hz short delay  
**-42:** 400Hz long delay  
**-400:** 400Hz motor start  
**-50:** DC instant trip\*  
**-51:** DC short delay\*  
**-52:** DC long delay\*  
**-500:** DC motor start  
**-60:** 50/60Hz instant trip  
**-61:** 50/60Hz short delay  
**-62:** 50/60Hz long delay  
**-600:** 50/60Hz motor start

**Rated Current**

Use three numbers to specify required value within ranges described below.  
**Rating**  
**0.50 to 30.0\***  
 Notes: 1. On multi-pole units, the poles are numbered left to right when viewed from terminal end.  
 2. \*15 amps maximum at 400Hz

**Mounting & Terminal Type**

**A-:** Metric M3 mounting inserts and if screw terminals M4.  
**L-:** PC board mounting plate & terminals, 90 facing left  
**R-:** PC board mounting plate & terminals, 90 facing right  
**S-:** PC board terminals, rear facing with front panel insert mount.  
 Note: Right and Left determined with breaker viewed from the rear, in normal vertical mounted position. (see pages 70 & 71)

**Handle Color & Markings**

**01:** Black with I/O markings

**Agency Approval**

**T:** TÜV\*  
**C:** CCC  
 Notes: 1. \*25 amperes max rated current for TÜV approval.  
 2. CCC Approval is pending.

Notes: A- The coding given permits a self-assigning part number. Other configurations may require a factory assigned part number. Typical examples are units with mixed ratings, combinations of styles or construction. With these, it is suggested that order entry be by description and/or drawings and a part number will be assigned. Additionally, it is a standard policy to establish a factory assigned part number wherever a descriptive drawing exists to provide cross reference, traceability and manufacturing control.





## AGENCY APPROVALS & CERTIFICATIONS

IPA Series				Rated Current (Amps)		Interrupting Capacity (Amps)	
Max Voltage Rating	Frequency (Hz)	Phase	Minimum Poles	UL/CSA	TÜV	UL1077 & CSA	TÜV
65	DC	-	1	.05 to 30	.05 to 25	3000	1000 (Note 1)
80	DC	-	1	.05 to 20	-	300	-
240	50/60	1 & 3	1	25.1 to 30	-	1000 (Note 1)	-
250	50/60	1 & 3	1	.05 to 25	.05 to 25	1000 (Note 2)	1000 (Note 1)
250	50/60	1	2	.05 to 30	.05 to 30	1500	1500 (Note 1)
250	400	1 & 3	1	.10 to 15	.05 to 15	1000	1000 (Note 1)
CPA Series				Rated Current (Amps)		Interrupting Capacity (Amps)	
Max Voltage Rating	Frequency (Hz)	Phase	Minimum Poles	UL/CSA	TÜV	UL1077 & CSA	TÜV
65	DC	-	1	1 to 30	-	1000	-

Notes: (1) with 4 times rated series backup fuse.  
 (2) with 80A max. series fuse.



## WARNINGS



### RISK OF MATERIAL DAMAGE AND HOT ENCLOSURE

- The product's side panels may be hot, allow the product to cool before touching
- Follow proper mounting instructions including torque values
- Do not allow liquids or foreign objects to enter this product

**Failure to follow these instructions can result in serious injury, or equipment damage.**



### HAZARD OF ELECTRIC SHOCK, EXPLOSION OR ARC FLASH

- Disconnect all power before installing or working with this equipment
- Verify all connections and replace all covers before turning on power

**Failure to follow these instructions can result in death or serious injury.**

Sensata Technologies, Inc. ("Sensata") data sheets are solely intended to assist designers ("Buyers") who are developing systems that incorporate Sensata products (also referred to herein as "components"). Buyer understands and agrees that Buyer remains responsible for using its independent analysis, evaluation and judgment in designing Buyer's systems and products. Sensata data sheets have been created using standard laboratory conditions and engineering practices. Sensata has not conducted any testing other than that specifically described in the published documentation for a particular data sheet. Sensata may make corrections, enhancements, improvements and other changes to its data sheets or components without notice.

Buyers are authorized to use Sensata data sheets with the Sensata component(s) identified in each particular data sheet. HOWEVER, NO OTHER LICENSE, EXPRESS OR IMPLIED, BY ESTOPPEL OR OTHERWISE TO ANY OTHER SENSATA INTELLECTUAL PROPERTY RIGHT, AND NO LICENSE TO ANY THIRD PARTY TECHNOLOGY OR INTELLECTUAL PROPERTY RIGHT, IS GRANTED HEREIN. SENSATA DATA SHEETS ARE PROVIDED "AS IS". SENSATA MAKES NO WARRANTIES OR REPRESENTATIONS WITH REGARD TO THE DATA SHEETS OR USE OF THE DATA SHEETS, EXPRESS, IMPLIED OR STATUTORY, INCLUDING ACCURACY OR COMPLETENESS. SENSATA DISCLAIMS ANY WARRANTY OF TITLE AND ANY IMPLIED WARRANTIES OF MERCHANTABILITY, FITNESS FOR A PARTICULAR PURPOSE, QUIET ENJOYMENT, QUIET POSSESSION, AND NON-INFRINGEMENT OF ANY THIRD PARTY INTELLECTUAL PROPERTY RIGHTS WITH REGARD TO SENSATA DATA SHEETS OR USE THEREOF.

All products are sold subject to Sensata's terms and conditions of sale supplied at [www.sensata.com](http://www.sensata.com) SENSATA ASSUMES NO LIABILITY FOR APPLICATIONS ASSISTANCE OR THE DESIGN OF BUYERS' PRODUCTS. BUYER ACKNOWLEDGES AND AGREES THAT IT IS SOLELY RESPONSIBLE FOR COMPLIANCE WITH ALL LEGAL, REGULATORY AND SAFETY-RELATED REQUIREMENTS CONCERNING ITS PRODUCTS, AND ANY USE OF SENSATA COMPONENTS IN ITS APPLICATIONS, NOTWITHSTANDING ANY APPLICATIONS-RELATED INFORMATION OR SUPPORT THAT MAY BE PROVIDED BY SENSATA.

Mailing Address: Sensata Technologies, Inc., 529 Pleasant Street, Attleboro, MA 02703, USA.

## CONTACT US

### Americas

508-236-2551  
 electrical-protection-sales@  
 sensata.com

### Europe, Middle East & Africa

+31743578156  
 info-sse@list.sensata.com

### Asia Pacific

sales.isasia@list.sensata.com  
 China +86 (21) 2306 1500  
 Japan +81 (45) 277 7117  
 Korea +82 (31) 601 2004  
 India +91 (80) 67920890  
 Rest of Asia +886 (2) 27602006  
 ext 2808

# Mouser Electronics

Authorized Distributor

Click to View Pricing, Inventory, Delivery & Lifecycle Information:

## Sensata:

[CPA-1-1-52-30.0-A-01](#) [CPA-6-1-52-30.0-A-01](#) [IPA-666-1-62-25.0-01-T](#) [IPA-6-1RS4-52-20.0-A-01](#) [IPA-6-1-52-25.0-A-01-T](#) [IPA-111-1-61-15.0-01](#) [IPA-11-1-60-1.00-01](#) [IPAH-666-1-61-25.0-A-01-T](#) [IPA-6-1REC4-500-15.0-01](#) [IPA-1-1-52-10.0-01-T](#) [IPA-6-1-51-5.00-A-01-T](#) [IPA-66-1REC4-52-25.0-01-T](#) [IPA-11-1-61-15.0-A-01-T](#) [IPA-6-1REC4-52-20.0-A-01](#) [IPA-1-1REC4-61-1.00-A-01-T](#) [IPAH-666-1-61-20.0-A-01-T](#) [IPAH-666-1-62-5.00-A-01-T](#) [IPA-1-1-52-5.00-A-01-T](#) [IPA-1-1-52-20.0-01-T](#) [IPA-1-1-62-10.0-A-01-T](#) [IPAH-66-1REC4-62-5.00-01](#) [IPA-11-1REC4-61-15.0-01](#) [IPA-6-1REG4-500-15.0-01](#) [IPA-1-1REC4-52-15.0-01](#) [IPA-1-1REC4-52-20.0-01](#) [IPA-6-1-52-20.0-A-01](#) [IPA-6-0-SW-10.0-A-01-T](#) [IPA-6-1-62-20.0-A-01-T](#) [IPA-6-1-52-15.0-A-01](#) [IPAH-66-1REC4-62-5.00-A-01](#) [IPA-11-1-51-2.50-01-T](#) [IPA-11-1-600-15.0-A-01-T](#) [IPA-11-1REC4-61-20.0-01](#) [IPA-6-1RS4-52-10.0-A-01](#) [IPAP-1-1-52-25.0-R-01](#) [IPAP-1-1-61-2.50-R-01-T](#) [IPA-1-1REC4-52-10.0-01](#) [IPA-666-1-600-20.0-A-01](#) [IPA-1-1-61-10.0-01](#) [IPA-1-1-52-1.00-A-01-T](#) [IPA-6-1REC4-62-25.0-01-T](#) [IPA-11-1REC4-51-15.0-01](#) [IPAH-66-1-61-5.00-A-01](#) [IPAH-666-1-42-10.0-01](#) [IPA-6-1REC4-52-25.0-01-T](#) [IPA-6-1-51-7.50-01-T](#) [IPA-66-1-600-10.0-A-01](#) [IPA-66-1-62-25.0-01-T](#) [IPA-6-1RS4-52-15.0-A-01](#) [IPAH-66-1REC4-61-5.00-A-01](#) [IPAH-11-1REC4-52-1.00-A-01](#) [IPA-111-1-62-25.0-A-01-T](#) [IPA-6-1-600-25.0-A-01-T](#) [IPAH-66-1REC4-62-20.0-01](#) [IPAP-1-1-51-10.0-R-01](#) [IPAP-1-1-52-10.0-AR-01-T](#) [IPA-666-1-600-25.0-A-01](#) [IPA-666-1REG4-62-10.0-01](#) [IPA-1-1-51-10.0-A-01-T](#) [IPA-6-1-52-15.0-01-T](#) [IPA-1-1-51-15.0-A-01-T](#) [IPA-1-1-51-15.0-01-T](#) [IPA-1-1-51-5.00-A-01-T](#) [IPA-1-1-52-15.0-A-01](#) [IPAH-11-1-52-20.0-A-01](#) [IPA-1-1-61-20.0-A-01](#) [IPA-6-1-52-5.00-01-T](#) [IPAP-1-1-51-5.00-R-01](#) [IPAH-666-1-62-10.0-A-01-T](#) [IPA-11-1-41-10.0-01-T](#) [IPA-1-1-62-25.0-A-01](#) [IPAP-1-1-61-10.0-R-01-T](#) [IPAH-66-1-62-20.0-A-01](#) [IPA-6-1REC4-51-15.0-A-01-T](#) [IPA-6-1-62-15.0-01-T](#) [IPAP-1-1-51-10.0-L-01-T](#) [IPAHP-11-1-61-20.0-S-01](#) [IPA-11-1-61-15.0-01](#) [IPA-6-1REG4-62-10.0-01](#) [IPAH-66-1-62-10.0-A-01](#) [IPA-66-1-51-10.0-01-T](#) [IPA-11-1-62-15.0-A-01-T](#) [IPAH-66-1-61-10.0-A-01](#) [IPA-66-1-52-20.0-01-T](#) [IPA-6-1REC4-52-.050-01-T](#) [IPA-1-1-62-20.0-A-01](#) [IPA-66-1-52-5.00-01-T](#) [IPA-1-1-51-15.0-01](#) [IPA-6-1REC4-62-.050-01-T](#) [IPA-1-1-61-1.00-A-01-T](#) [IPA-1-1REC4-52-20.0-A-01-T](#) [IPA-66-1-62-15.0-A-01](#) [IPA-1-1-52-20.0-A-01](#) [IPA-11-1-51-5.00-01](#) [IPA-1-1REC4-52-15.0-01-T](#) [IPA-1-1-61-15.0-A-01-T](#) [IPA-1-1-52-25.0-A-01](#) [IPA-11-1-61-7.50-01](#) [IPA-6-1-51F-1.50-A-01](#) [IPA-6-1-51-20.0-A-01-T](#)