

Features

1. Built-in bias resistors enable the configuration of an inverter circuit without connecting external input resistors(see equivalent circuit).
2. The bias resistors consist of thin-film resistors with complete isolation to allow negative biasing of the input. They also have the advantage of almost completely eliminating parasitic effects.
3. Only the on/off conditions need to be set for operation, making device design easy.

●Equivalent circuit

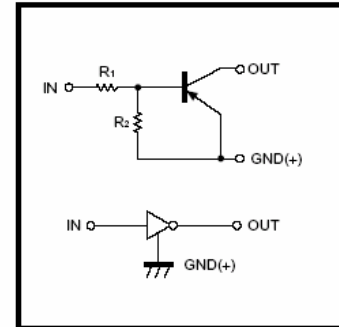

PIN CONNENCTIONS AND MARKING

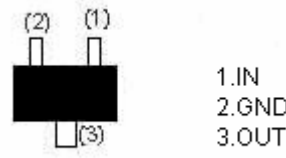
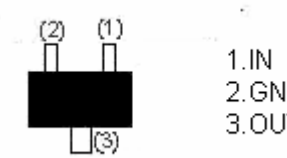
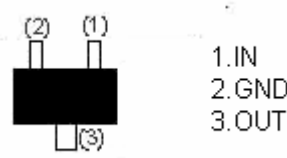
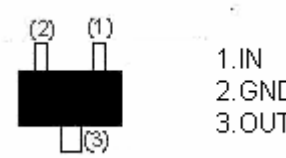
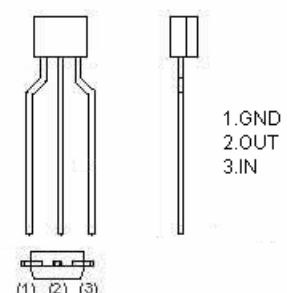
<p>DTA114EE</p>  <p>1.IN 2.GND 3.OUT</p> <p>SOT-523 Abbreviated symbol: 14</p>	<p>DTA114EUA</p>  <p>1.IN 2.GND 3.OUT</p> <p>SOT-323 Abbreviated symbol: 14</p>
<p>DTA114EKA</p>  <p>1.IN 2.GND 3.OUT</p> <p>SOT-23-3L Abbreviated symbol: 14</p>	<p>DTA114ECA</p>  <p>1.IN 2.GND 3.OUT</p> <p>SOT-23 Abbreviated symbol: 14</p>
<p>DTA114ESA</p>  <p>1.GND 2.OUT 3.IN</p> <p>TO-92S</p>	

Absolute maximum ratings(Ta=25°C)

Parameter	Symbol	Limits (DTA114E□)					Unit
		E	UA	CA	KA	SA	
Supply voltage	V _{CC}			-50			V
Input voltage	V _{IN}			-40~10			V
Output current	I _O			-50			mA
	I _{C(MAX)}			-100			
Power dissipation	Pd	150		200		300	mW
Junction temperature	T _j			150			°C
Storage temperature	T _{stg}			-55~150			°C

Electrical characteristics (Ta=25°C)

Parameter	Symbol	Min.	Typ	Max.	Unit	Conditions
Input voltage	V _{I(off)}			-0.5	V	V _{CC} =-5V, I _O =-100μA
	V _{I(on)}	-3				V _O =-0.3V, I _O =-10 mA
Output voltage	V _{O(on)}			-0.3	V	I _O /I _F =-10mA/-0.5mA
Input current	I _I			-0.88	mA	V _I =-5V
Output current	I _{O(off)}			-0.5	μA	V _{CC} =-50V, V _I =0
DC current gain	G _I	30				V _O =-5V, I _O =-5mA
Input resistance	R ₁	7	10	13	KΩ	
Resistance ratio	R ₂ /R ₁	0.8	1	1.2		
Transition frequency	f _T		250		MHz	V _{CE} =-10V, I _E =5mA, f=100MHz

Typical Characteristics

●Electrical characteristic curves

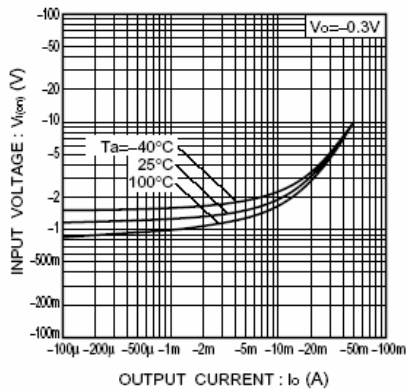

Fig.1 Input voltage vs. output current (ON characteristics)

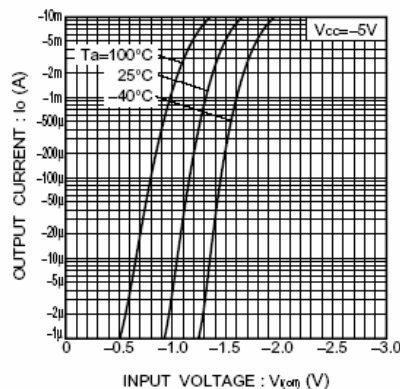

Fig.2 Output current vs. input voltage (OFF characteristics)

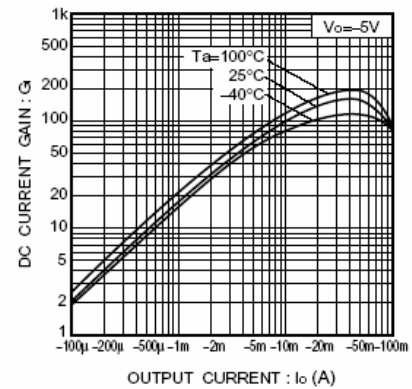

Fig.3 DC current gain vs. output current

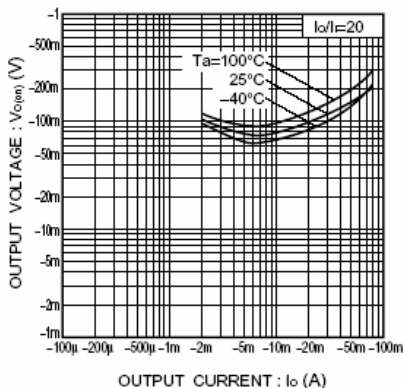

Fig.4 Output voltage vs. output current