

■ Features

- High Luminous LEDs
- Low Power Consumption
- UV Resistant Epoxy
- Specified at IF = 1 mA
- Water Clear Type

■ Applications

- Background illumination
- Communications equipment
- Low power DC circuits
- General lighting purposes

■ Outline Dimension

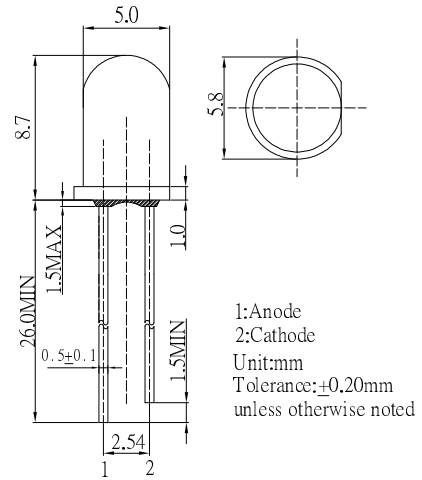

■ Absolute Maximum Rating (Ta=25°C)

Item	Symbol	Value		Unit
		W/M/B/PG	YG/Y/O/R	
DC Forward Current	IF	30	30	mA
Pulse Forward Current#	IFP	100	100	mA
Reverse Voltage	VR	5	5	V
Power Dissipation	PD	102	66	mW
Operating Temperature	Topr	-30 ~ +85		°C
Storage Temperature	Tstg	-40~ +100		°C
Lead Soldering Temperature	Tsol	260°C/5sec		-

■ Directivity

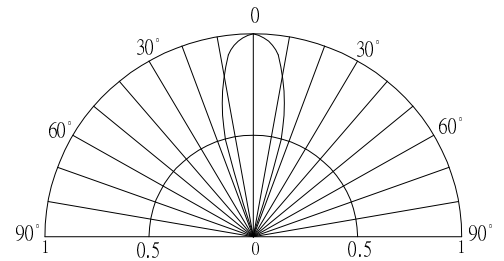

#Pulse width Max.10ms Duty ratio max 1/10

■ Electrical -Optical Characteristics (Ta=25°C)

Part Number	Color			VF (V)			IR(μA)	IV(mcd)			λD(nm)			θ1/2(deg)
				Min.	Typ.	Max.	Max.	Min.	Typ.	Max.	Min.	Typ.	Max.	Typ.
				IF=1mA			VR=5V	IF=1mA						
OSW54K5A31A-1MA	White	W		-	2.8	3.4	10	1560	2180	-	5500-8500K(X:0.27,Y:0.28)			30
OSM54K5A31A-1MA	Warm White	M	■	-	2.8	3.4	10	1120	1560	-	2700-3200K(X:0.45,Y:0.41)			30
OSB5DA5A31A-1MA	Blue	B	■	-	2.8	3.4	10	750	1120	-	465	470	475	30
OSG58A5A31A-1MA	Pure Green	PG	■	-	2.8	3.4	10	1560	2180	-	520	525	530	30
OSY5PA5A31A-1MA	Yellow	Y	■	-	1.8	2.2	10	750	1120	-	585	590	595	30
OSO5PA5A31A-1MA	Orange	O	■	-	1.8	2.2	10	750	1120	-	600	605	610	30
OSR5PA5A31A-1MA	Red	R	■	-	1.8	2.2	10	750	1120	-	620	625	630	30

*1 Tolerance of measurements of chromaticity coordinate is ±10% *2 Tolerance of measurements of dominant wavelength is ±1nm

*3 Tolerance of measurements of luminous intensity is ±15% *4 Tolerance of measurements of forward voltage is +0.1V

LED & Application Technologies

