

HLMP-1600

T-1³/₄ (5 mm), T-1 (3 mm), 5 Volt, 12 Volt,
Integrated Resistor LED Lamps



Data Sheet

HLMP-1600, HLMP-1601, HLMP-1620, HLMP-1621
HLMP-1640, HLMP-1641, HLMP-3600, HLMP-3601
HLMP-3650, HLMP-3651, HLMP-3680, HLMP-3681

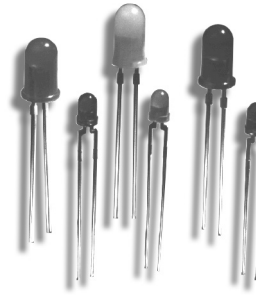

Description

The 5 volt and 12 volt series lamps contain an integral current limiting resistor in series with the LED. This allows the lamp to be driven from a 5 volt/12 volt source without an external current limiter. The red LEDs are made from GaAsP on a GaAs substrate. The High Efficiency Red and Yellow devices use GaAsP on a GaP substrate.

The green devices use GaP on a GaP substrate. The diffused lamps provide a wide off-axis viewing angle.

The T-1³/₄ lamps are provided with sturdy leads suitable for wire wrap applications. The T-1³/₄ lamps may be front panel mounted by using the HLMP-0103 clip and ring.

Features

- Integral current limiting resistor
- TTL compatible
Requires no external current Limiter with 5 volt/12 volt supply
- Cost effective
Saves space and resistor cost
- Wide viewing angle
- Available in all colors
Red, High Efficiency Red, Yellow, and High Performance Green in T-1 and T-13/4 packages

Package Dimensions

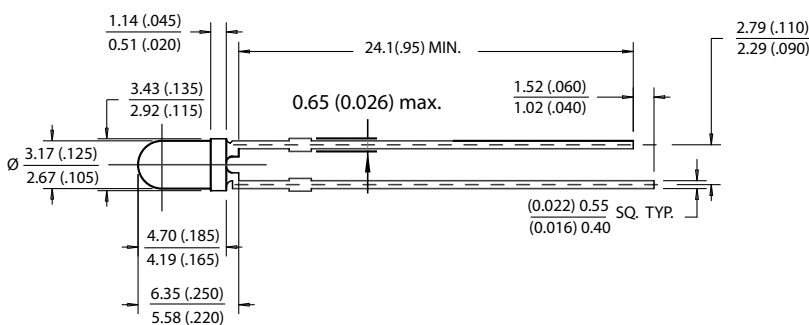

Figure A. T-1 package.

Notes:

1. All dimensions are in mm (inches).
2. An epoxy meniscus may extend about 1 mm (0.040") down the leads.
3. For PCB hole recommendations, see the Precautions section.

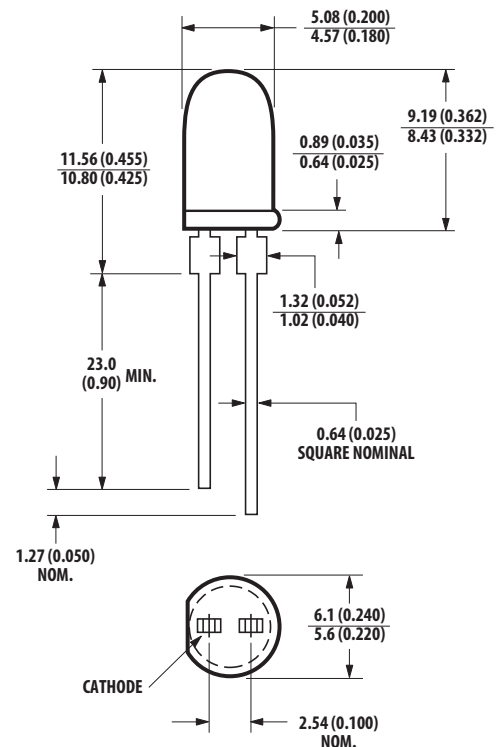

Figure B. T-1³/₄ package.

Selection Guide

Color	Package Description	Package Outline	$2\theta_{1/2}^{[1]}$	Operating Voltage (V)	Part Number HLMP-	Luminous Intensity lv (mcd)	
						Min.	Max.
Red	T-1 Tinted Diffused	A	60	5	1600	2.1	-
					1600-D00xx	2.1	-
			60	12	1601	2.1	-
					1601-D00xx	2.1	-
	T-1 3/4 Tinted Diffused	B	60	5	1601-GH0xx	8.6	27.6
					3600	2.1	-
			60	12	3600-D00xx	2.1	-
					3601	2.1	-
Yellow	T-1 Tinted Diffused	A	60	5	1620	2.2	-
					1620-C00xx	2.2	-
			60	12	1620-C0Bxx	2.2	-
					1620-EFBxx	3.4	10.8
	T-1 3/4 Tinted Diffused	B	60	5	1621	2.2	-
					1621-C00xx	2.2	-
			60	12	3650	2.2	-
					3650-C00xx	2.2	-
Green	T-1 Tinted Diffused	A	60	5	3651	2.2	-
					3651-C00xx	2.2	-
			60	12	1640	1.6	-
					1640-B00xx	1.6	-
	T-1 3/4 Tinted Diffused	B	60	5	1640-B0Dxx	1.6	-
					1640-DE0xx	4.2	13.4
			60	12	1641	1.6	-
					1641-B00xx	1.6	-
T-1 3/4 Tinted Diffused	B	60	5	3680	1.6	-	
				3680-B00xx	1.6	-	
		60	12	3681	1.6	-	
				3681-B00xx	1.6	-	

Note:

1. $\theta_{1/2}$ is the off-axis angle at which the luminous intensity is 1/2 the axial luminous intensity.

Part Numbering System

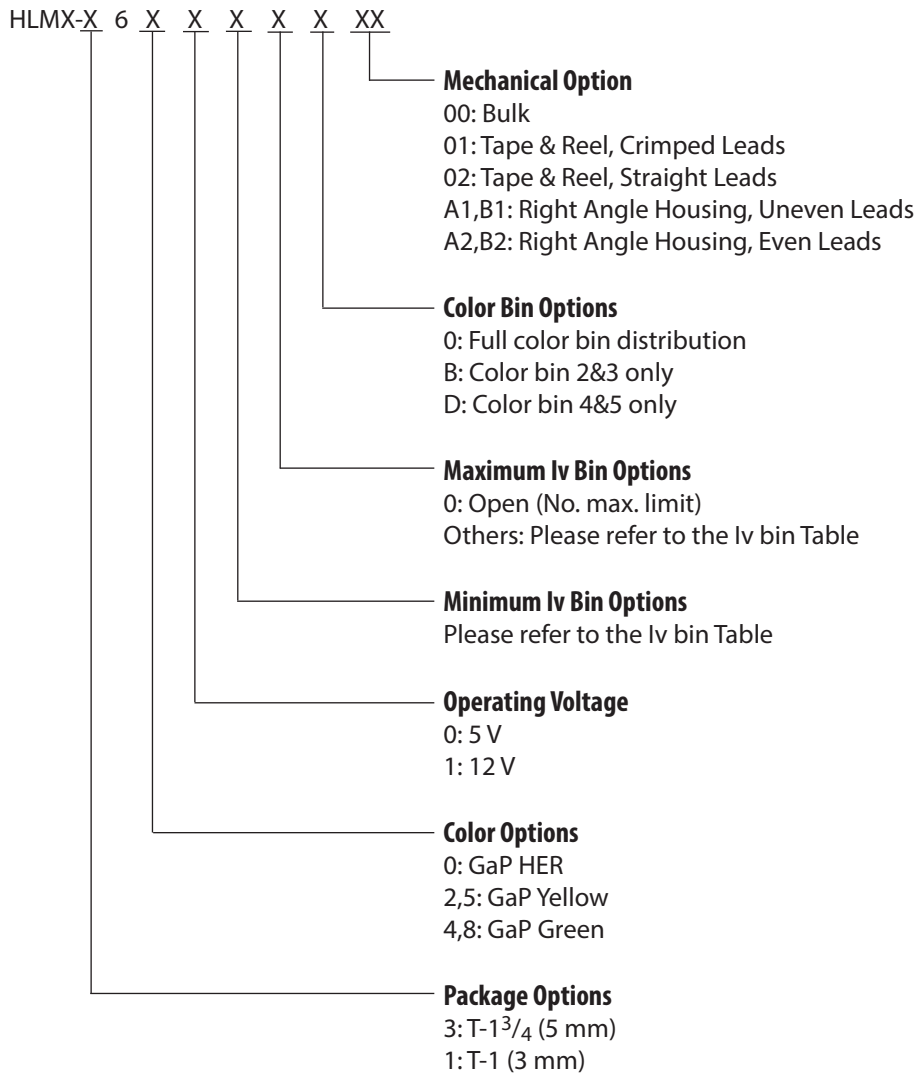

Absolute Maximum Ratings at $T_A = 25^\circ\text{C}$

	Red/HER/Yellow 5 Volt Lamps	Red/HER/Yellow 12 Volt Lamps	Green 5 Volt Lamps	Green 12 Volt Lamps
DC Forward Voltage ($T_A = 25^\circ\text{C}$)	7.5 Volts ^[2]	15 Volts ^[3]	7.5 Volts ^[2]	15 Volts ^[3]
Reverse Voltage ($I_R = 100 \mu\text{A}$)	5 Volts	5 Volts	5 Volts	5 Volts
Operating Temperature Range	-40°C to 85°C	-40°C to 85°C	-20°C to 85°C	-20°C to 85°C
Storage Temperature Range	-40°C to 100°C	-40°C to 100°C	-40°C to 100°C	-40°C to 100°C

Notes:

- Derate from $T_A = 50^\circ\text{C}$ at 0.071 V/°C, see Figure 3.
- Derate from $T_A = 50^\circ\text{C}$ at 0.086 V/°C, see Figure 4.

Electrical/Optical Characteristics at $T_A = 25^\circ\text{C}$

Symbol	Description	High Efficiency Red			Yellow			Green			Unit	Test Condition
		Min.	Typ.	Max.	Min.	Typ.	Max.	Min.	Typ.	Max.		
λ_p	Peak Wavelength		635			583			565		nm	
λ_d	Dominant Wavelength		626			585			569		nm	Note 4
$\Delta\lambda_{1/2}$	Spectral Line Halfwidth		40			36			28		nm	
$R\theta_{J-PIN}$	Thermal Resistance		290			290			290		$^\circ\text{C}/\text{W}$	Junction to Cathode Lead (Note 6)
$R\theta_{J-PIN}$	Thermal Resistance		210			210			210		$^\circ\text{C}/\text{W}$	Junction to Cathode Lead (Note 7)
I_F	Forward Current 12 V Devices		13	20		13	20		13	20	mA	$V_F = 12\text{ V}$
I_F	Forward Current 5 V Devices		10	15		10	15		10	15	mA	$V_F = 5\text{ V}$
η_V	Luminous Efficacy		145			500			595		lumen/Watt	Note 2
V_R	Reverse Breakdown Voltage	5.0			5.0			5.0			V	$I_R = 100\ \mu\text{A}$

Notes:

4. The dominant wavelength, λ_d , is derived from the CIE chromaticity diagram and represents the single wavelength which defines the color of the device.
5. Radiant intensity, I_e , in watts/steradian, may be found from the equation $I_e = I_v/\eta_V$, where I_v is the luminous intensity in candelas and η_V is the luminous efficacy in lumens/Watt.
6. For Figure A package type.
7. For Figure B package type.

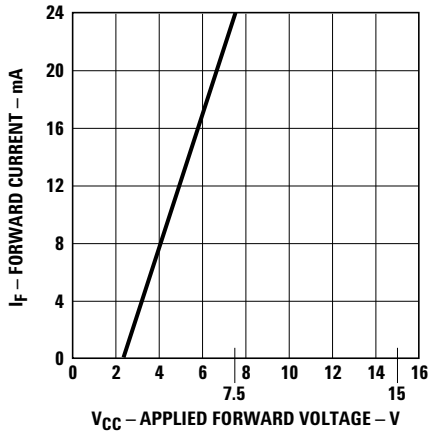

Figure 1. Forward current vs. applied forward voltage. 5 volt devices.

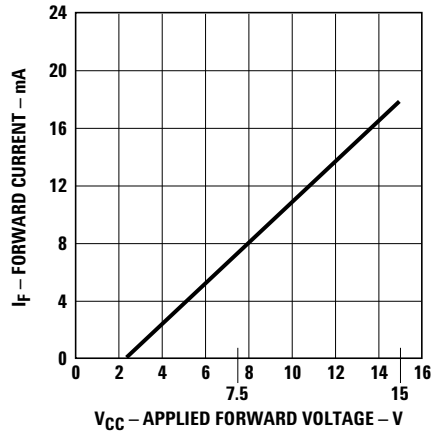

Figure 2. Forward current vs. applied forward voltage. 12 volt devices.

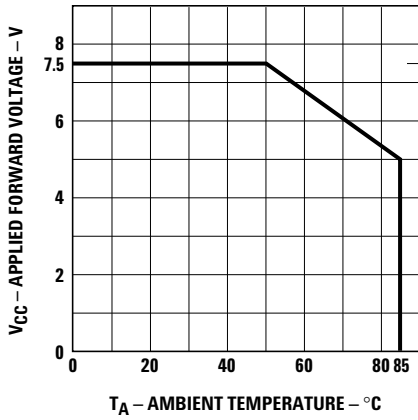

Figure 3. Maximum allowed applied forward voltage vs. ambient temperature $R\theta_{JA} = 175^{\circ}\text{C/W}$. 5 volt devices.

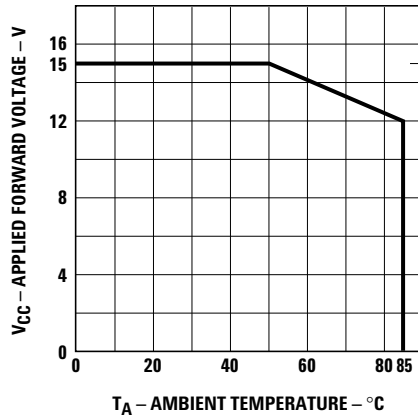

Figure 4. Maximum allowed applied forward voltage vs. ambient temperature $R\theta_{JA} = 175^{\circ}\text{C/W}$. 12 volt devices.

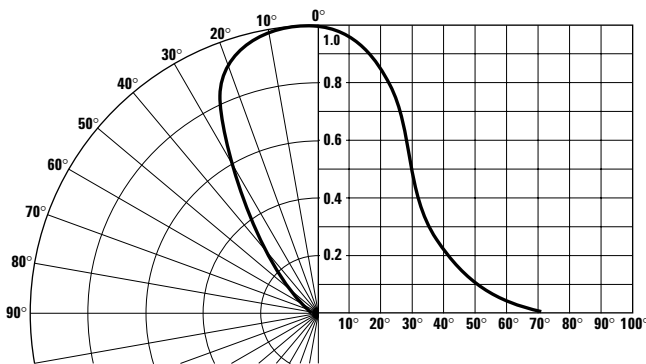

Figure 5. Relative luminous intensity vs. angular displacement for T-1 package.

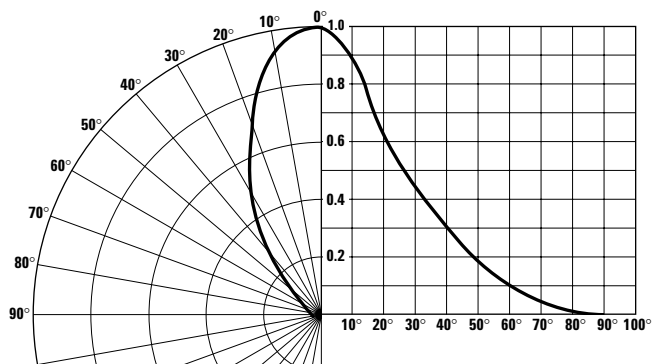

Figure 6. Relative luminous intensity vs. angular displacement for T-1^{3/4} package.

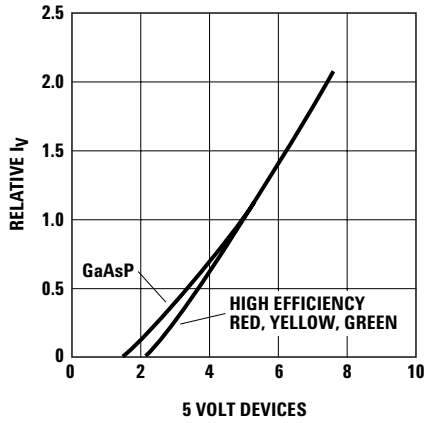

Figure 7. Relative luminous intensity vs. applied forward voltage. 5 volt devices.

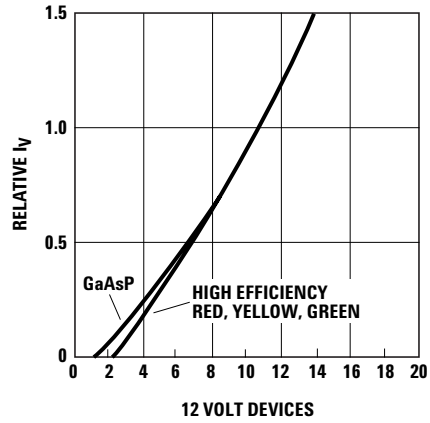

Figure 8. Relative luminous intensity vs. applied forward voltage. 12 volt devices.

Intensity Bin Limit

Color	Bin	Intensity Range (mcd)	
		Min.	Max.
Red	D	2.4	3.8
	E	3.8	6.1
	F	6.1	9.7
	G	9.7	15.5
	H	15.5	24.8
	I	24.8	39.6
	J	39.6	63.4
	K	63.4	101.5
	L	101.5	162.4
	M	162.4	234.6
	N	234.6	340.0
	O	340.0	540.0
	P	540.0	850.0
	Q	850.0	1200.0
	R	1200.0	1700.0
	S	1700.0	2400.0
	T	2400.0	3400.0
	U	3400.0	4900.0
	V	4900.0	7100.0
	W	7100.0	10200.0
X	10200.0	14800.0	
Y	14800.0	21400.0	
Z	21400.0	30900.0	

Maximum tolerance for each bin limit is ±18%.

Intensity Bin Limit (Con't)

Color	Bin	Intensity Range (mcd)	
		Min.	Max.
Yellow	C	2.5	4.0
	D	4.0	6.5
	E	6.5	10.3
	F	10.3	16.6
	G	16.6	26.5
	H	26.5	42.3
	I	42.3	67.7
	J	67.7	108.2
	K	108.2	173.2
	L	173.2	250.0
	M	250.0	360.0
	N	360.0	510.0
	O	510.0	800.0
	P	800.0	1250.0
	Q	1250.0	1800.0
	R	1800.0	2900.0
	S	2900.0	4700.0
	T	4700.0	7200.0
	U	7200.0	11700.0
	V	11700.0	18000.0
W	18000.0	27000.0	
Y	14800.0	21400.0	
Z	21400.0	30900.0	

Intensity Bin Limit (Con't)

Color	Bin	Intensity Range (mcd)	
		Min.	Max.
Green	B	1.8	2.9
	C	2.9	4.7
	D	4.7	7.6
	E	7.6	12.0
	F	12.0	19.1
	G	19.1	30.7
	H	30.7	49.1
	I	49.1	78.5
	J	78.5	125.7
	K	125.7	201.1
	L	201.1	289.0
	M	289.0	417.0
	N	417.0	680.0
	O	680.0	1100.0
	P	1100.0	1800.0
	Q	1800.0	2700.0
	R	2700.0	4300.0
	S	4300.0	6800.0
	T	6800.0	10800.0
U	10800.0	16000.0	
V	16000.0	25000.0	
W	25000.0	40000.0	
Z	21400.0	30900.0	

Color Categories

Color	Cat #	Lambda (nm)	
		Min.	Max.
Green	6	561.5	564.5
	5	564.5	567.5
	4	567.5	570.5
	3	570.5	573.5
	2	573.5	576.5
	1	582.0	584.5
Yellow	3	584.5	587.0
	2	587.0	589.5
	4	589.5	592.0
	5	592.0	593.0

Tolerance for each bin limit is ± 0.5 nm.

Mechanical Option Matrix

Mechanical Option Code	Definition
00	Bulk Packaging, minimum increment 500 pcs/bag
01	Tape & Reel, crimped leads, minimum increment 1300 pcs/bag
02	Tape & Reel, straight leads, minimum increment 1300 pcs/bag
A1	T-1, Right Angle Housing, uneven leads, minimum increment 500 pcs/bag
A2	T-1, Right Angle Housing, even leads, minimum increment 500 pcs/bag
B1	T-1 ³ / ₄ Angle Housing, uneven lead, minimum increment 500 pcs/bag
B2	T-1 ³ / ₄ Angle Housing, even leads, minimum increment 500 pcs/bag

Note: All categories are established for classification of products. Products may not be available in all categories. Please contact your local Avago representative for further clarification/information.

Precautions

Lead Forming

- The leads of an LED lamp may be preformed or cut to length prior to insertion and soldering into PC board.
- If lead forming is required before soldering, care must be taken to avoid any excessive mechanical stress induced to LED package. Otherwise, cut the leads of LED to length after soldering process at room temperature. The solder joint formed will absorb the mechanical stress of the lead cutting from traveling to the LED chip die attach and wirebond.
- It is recommended that tooling made to precisely form and cut the leads to length rather than rely upon hand operation.

Soldering Conditions

- Care must be taken during PCB assembly and soldering process to prevent damage to LED component.
- The closest LED is allowed to solder on board is 1.59 mm below the body (encapsulant epoxy) for those parts without standoff.
- Recommended soldering conditions:

	Wave Soldering	Manual Solder Dipping
Pre-heat Temperature	105°C Max.	–
Pre-heat Time	30 sec Max.	–
Peak Temperature	250°C Max.	260°C Max.
Dwell Time	3 sec Max.	5 sec Max.

- Wave soldering parameter must be set and maintained according to recommended temperature and dwell time in the solder wave. Customer is advised to periodically check on the soldering profile to ensure the soldering profile used is always conforming to recommended soldering condition.
- If necessary, use fixture to hold the LED component in proper orientation with respect to the PCB during soldering process.
- Proper handling is imperative to avoid excessive thermal stresses to LED components when heated. Therefore, the soldered PCB must be allowed to cool to room temperature, 25°C, before handling.
- Special attention must be given to board fabrication, solder masking, surface plating and lead holes size and component orientation to assure solderability.
- Recommended PC board plated through hole sizes for LED component leads:

	LED Component Lead Size	Diagonal	Plated Through-Hole Diameter
Lead size (typ.)	0.45 × 0.45 mm (0.018 × 0.018 in.)	0.636 mm (0.025 in)	0.98 to 1.08 mm (0.039 to 0.043 in)
Dambar shear-off area (max.)	0.65 mm (0.026 in)	0.919 mm (0.036 in)	
Lead size (typ.)	0.50 × 0.50 mm (0.020 × 0.020 in.)	0.707 mm (0.028 in)	1.05 to 1.15 mm (0.041 to 0.045 in)
Dambar shear-off area (max.)	0.70 mm (0.028 in)	0.99 mm (0.039 in)	

Note: Refer to application note AN1027 for more information on soldering LED components.

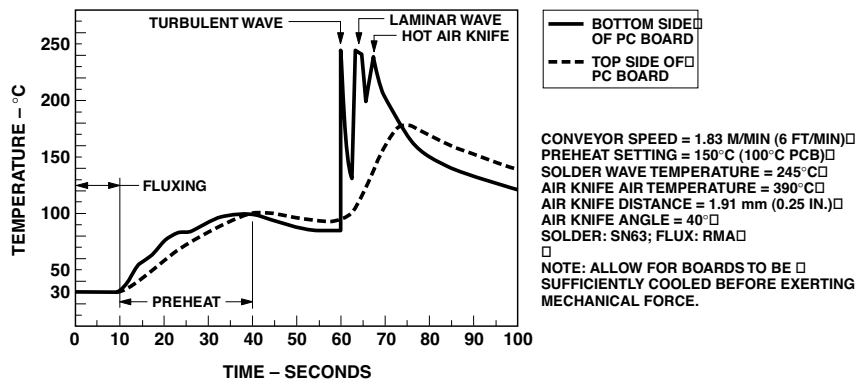

Figure 9. Recommended wave soldering profile.

For product information and a complete list of distributors, please go to our web site: www.avagotech.com

Mouser Electronics

Authorized Distributor

Click to View Pricing, Inventory, Delivery & Lifecycle Information:

[Broadcom Limited:](#)

[HLMP-1621](#) [HLMP-1640](#) [HLMP-1641](#) [HLMP-3600](#) [HLMP-3601](#) [HLMP-3650](#) [HLMP-3651](#) [HLMP-3680](#)