

Data Sheet



Description

The 3W mini power LED light source is a high-performance, energy-efficient device that can handle high-thermal and high-driving current. The metal slug is electrically isolated.

The white mini power LED is available in the range of color temperature from 2700K to 10000K.

The low profile package design and ultra small footprint is suitable for a wide variety of applications especially where space and height is a constraint.

The package is compatible with reflow soldering process. To facilitate easy pick and place assembly, the LEDs are packed in EIA-compliant tape and reel.

Features

- Available in cool white, neutral white, and warm white
- Small footprint and low profile
- Symmetrical outline
- Energy efficient
- Direct heat transfer from metal slug to mother board
- Compatible with reflow soldering process
- High current operation
- Long operation life
- Wide viewing angle
- Silicone encapsulation
- Non-ESD sensitive (threshold > 16 kV)
- MSL 1 products

Applications

- Sign backlight
- Safety, exit, and emergency sign lightings
- Specialty lighting, such as task lighting and reading lights
- Retail display
- Commercial lighting
- Accent or marker lightings, strip or step lightings
- Portable lightings, bicycle head lamp, torch lights
- Decorative lighting
- Architectural lighting
- Pathway lighting
- Street lighting
- Pedestrian street lighting
- Tunnel lighting

CAUTION: The customer is advised to keep the LEDs in the moisture barrier bag (MBB) when not in use as prolonged exposure to environment might cause the silver plated leads to tarnish, which might cause difficulties in soldering.

Figure 1 ASMT-Jx32 Package Outline Drawing

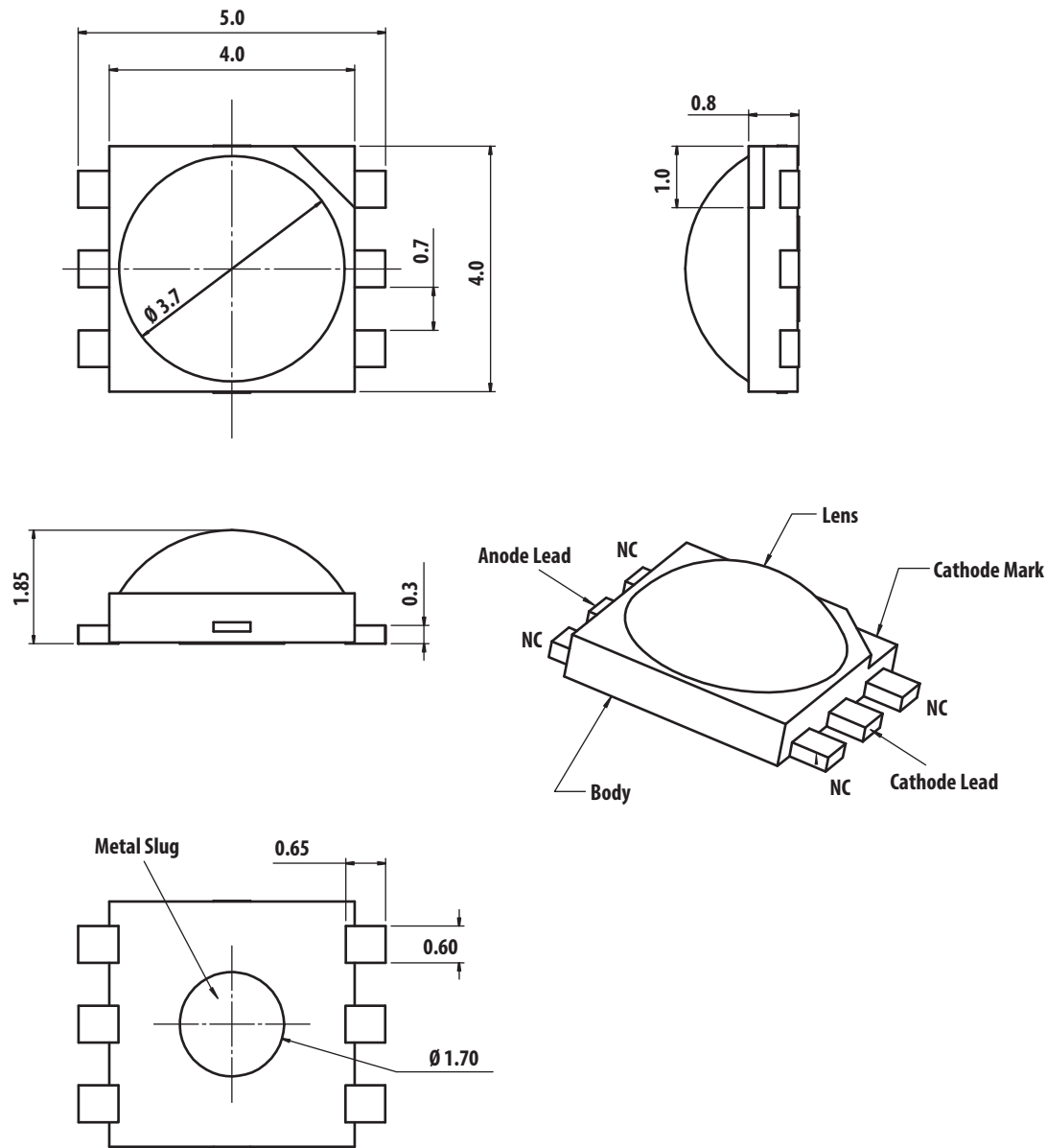
**NOTE**

1. All dimensions in millimeters.
2. Tolerance is ± 0.1 mm unless otherwise specified.
3. Terminal finish: Ag plating.
4. Corresponding NC (No Connection) leads adjacent to anode and cathode leads can be electrically short.

Device Selection Guide ($T_J = 25^\circ\text{C}$)

Part Number	Color	Luminous Flux (lm), $\Phi_V^{a, b}$			Test Current (mA)	Dice Technology	Electrically Isolated Metal Slug
		Min.	Typ.	Max.			
ASMT-JW32-NWY01	Cool White	113.6	140.0	168.4	350	InGaN	Yes
ASMT-JW32-NWYJ1		113.6	140.0	168.4	350	InGaN	Yes
ASMT-JN32-NWY01	Neutral White	113.6	140.0	168.4	350	InGaN	Yes
ASMT-JN32-NWYH1		113.6	140.0	168.4	350	InGaN	Yes
ASMT-JY32-NWY01	Warm White	113.6	130.0	168.4	350	InGaN	Yes
ASMT-JY32-NWYK1		113.6	130.0	168.4	350	InGaN	Yes

- a. Luminous flux, Φ_V is the total flux output measured with an integrating sphere at a single current pulse condition.
b. Flux tolerance is $\pm 10\%$.

Absolute Maximum Ratings

Parameter	InGaN	Units
DC Forward Current ^a	700	mA
Peak Pulsing Current	2400	mA
Power Dissipation	2730	mW
LED Junction Temperature	135	$^\circ\text{C}$
Operating Metal Slug Temperature Range at 350 mA	-40 to +120	$^\circ\text{C}$
Operating Metal Slug Temperature Range at 700 mA	-40 to +105	$^\circ\text{C}$
Storage Temperature Range	-40 to +120	$^\circ\text{C}$
Soldering Temperature	See Figure 17	
Reverse Voltage ^b	Not recommended	

- a. Derate linearly based on [Figure 13](#) and [Figure 14](#).
b. Not designed for reverse bias operation.

Optical Characteristics at 350 mA ($T_J = 25^\circ\text{C}$)

Part Number	Color	Correlated Color Temperature, CCT (Kelvin)		Viewing Angle, $2\theta_{1/2}^a$ ($^\circ$)	Luminous Efficiency (lm/W)
		Min.	Max.	Typ.	Typ.
ASMT-JW32-NWY01	Cool White	4500	10000	140	125
ASMT-JW32-NWYJ1		5000	6300	140	125
ASMT-JN32-NWY01	Neutral White	3500	4500	140	125
ASMT-JN32-NWYH1		3800	4500	140	125
ASMT-JY32-NWY01	Warm White	2700	3500	140	116
ASMT-JY32-NWYK1		3050	3500	140	116

- a. $\theta_{1/2}$ is the off-axis angle where the luminous intensity is half of the peak intensity.

Electrical Characteristic at 350 mA ($T_J = 25^\circ\text{C}$)

Dice Type	Forward Voltage, V_F (Volts)			Thermal Resistance, $R_{\theta j-ms}$ ($^\circ\text{C}/\text{W}$) ^a
	Min.	Typ.	Max.	Typ.
InGaN	2.8	3.2	3.5	9

a. $R_{\theta j-ms}$ is thermal resistance from LED junction to metal slug.

Optical and Electrical Characteristic at 700 mA ($T_J = 25^\circ\text{C}$)

Part Number	Color	Luminous Flux (lm), Φ_V	Forward Voltage, V_F (Volts)
		Typ.	Typ.
ASMT-JW32-NWY01	Cool White	239.0	3.6
ASMT-JW32-NWYJ1		239.0	3.6
ASMT-JN32-NWY01	Neutral White	239.0	3.6
ASMT-JN32-NWYH1		239.0	3.6
ASMT-JY32-NWY01	Warm White	222.0	3.6
ASMT-JY32-NWYK1		222.0	3.6

Part Numbering System

A S M T - J x₁ 3 2 - x₂ x₃ x₄ x₅ x₆

Code	Description	Option	
x ₁	Color	W	Cool White
		N	Neutral White
		Y	Warm White
x ₂	Dice Type	N	InGaN
x ₃	Minimum Flux Bin	Refer to Device Selection Guide	
x ₄	Maximum Flux Bin		
x ₅	Color Bin Selection	Refer to Color Bin Selection Table	
x ₆	Packaging Option	0	Tube
		1	Tape and Reel

Bin Information

Flux Bin Limit (x_3, x_4)

Bin ID	Luminous Flux (lm) at 350 mA	
	Min.	Max.
U	87.4	99.6
V	99.6	113.6
W	113.6	129.5
X	129.5	147.7
Y	147.7	168.4

Color Bin Selection (x_5)

Individual reel will contain parts from one color bin selection only.

Cool White

Selection	Bin ID
0	Full Distribution
E	VM, UM, VN, and UN
F	WM, VM, WN, and VN
G	XM, WM, XN, and WN
H	UN, VN, U0, and V0
J	WN, VN, W0, and V0
K	XN, WN, X0, and W0
L	V0, U0, VP, and UP
M	W0, V0, WP, VP, and WQ
N	X0, W0, XP, WP, and WQ
P	Y0
Q	YA

Warm White

Selection	Bin ID
0	Full Distribution
E	NM, MM, N1, and M1
F	PM, NM, P1, and N1
G	QM, PM, Q1, and P1
H	M1, N1, M0, and N0
J	P1, N1, P0, and N0
K	Q1, P1, Q0, and P0
L	N0, M0, NA, and MA
M	P0, N0, PA, and NA
N	Q0, P0, QA, and PA

Neutral White

Selection	Bin ID
0	Full Distribution
E	SM, RM, S1, and R1
F	TM, SM, TN, and S1
G	S1, R1, S0, and R0
H	TN, S1, T0, and S0
J	S0, R0, SA, and RA
K	T0, S0, TP, and SA

Color Bin Limits

Cool White	Color Limits (Chromaticity Coordinates)				
Bin UM	x	0.365	0.367	0.348	0.347
	y	0.386	0.400	0.385	0.372
Bin UN	x	0.365	0.362	0.346	0.347
	y	0.386	0.372	0.359	0.372
Bin UO	x	0.362	0.360	0.344	0.346
	y	0.372	0.357	0.344	0.359
Bin UP	x	0.360	0.357	0.343	0.344
	y	0.357	0.342	0.331	0.344
Bin VM	x	0.329	0.329	0.348	0.347
	y	0.357	0.369	0.385	0.372
Bin VN	x	0.329	0.329	0.347	0.346
	y	0.345	0.357	0.372	0.359
Bin VO	x	0.329	0.329	0.346	0.344
	y	0.331	0.345	0.359	0.344
Bin VP	x	0.329	0.344	0.343	0.329
	y	0.331	0.344	0.331	0.320
Bin WM	x	0.329	0.329	0.315	0.314
	y	0.369	0.357	0.344	0.355
Bin WN	x	0.329	0.316	0.315	0.329
	y	0.345	0.333	0.344	0.357
Bin WO	x	0.329	0.329	0.317	0.316
	y	0.345	0.331	0.320	0.333
Bin WP	x	0.329	0.329	0.318	0.317
	y	0.331	0.320	0.310	0.320
Bin WQ	x	0.329	0.329	0.319	0.318
	y	0.320	0.310	0.300	0.310
Bin XM	x	0.301	0.314	0.315	0.303
	y	0.342	0.355	0.344	0.333
Bin XN	x	0.305	0.303	0.315	0.316
	y	0.322	0.333	0.344	0.333
Bin XO	x	0.308	0.305	0.316	0.317
	y	0.311	0.322	0.333	0.320
Bin XP	x	0.308	0.317	0.319	0.303
	y	0.311	0.320	0.300	0.293
Bin YO	x	0.308	0.283	0.274	0.303
	y	0.311	0.284	0.301	0.333
Bin YA	x	0.308	0.311	0.290	0.283
	y	0.311	0.293	0.270	0.284

Tolerance: ± 0.01

Warm White	Color Limits (Chromaticity Coordinates)				
Bin MM	x	0.471	0.460	0.473	0.486
	y	0.451	0.430	0.432	0.455
Bin M1	x	0.460	0.453	0.467	0.473
	y	0.430	0.416	0.419	0.432
Bin M0	x	0.453	0.444	0.459	0.467
	y	0.416	0.399	0.403	0.419
Bin M	x	0.459	0.444	0.436	0.451
	y	0.403	0.399	0.384	0.389
Bin NM	x	0.454	0.444	0.460	0.471
	y	0.446	0.426	0.430	0.451
Bin N1	x	0.444	0.438	0.453	0.460
	y	0.426	0.412	0.416	0.430
Bin N0	x	0.438	0.429	0.444	0.453
	y	0.412	0.394	0.399	0.416
Bin NA	x	0.444	0.429	0.422	0.436
	y	0.399	0.394	0.379	0.384
Bin PM	x	0.438	0.430	0.444	0.454
	y	0.440	0.421	0.426	0.446
Bin P1	x	0.430	0.424	0.438	0.444
	y	0.421	0.407	0.412	0.426
Bin P0	x	0.424	0.416	0.429	0.438
	y	0.407	0.389	0.394	0.412
Bin PA	x	0.429	0.416	0.410	0.422
	y	0.394	0.389	0.374	0.379
Bin QM	x	0.421	0.414	0.430	0.438
	y	0.433	0.414	0.421	0.4440
Bin Q1	x	0.414	0.409	0.424	0.430
	y	0.414	0.400	0.407	0.421
Bin Q0	x	0.409	0.402	0.416	0.424
	y	0.400	0.382	0.389	0.407
Bin QA	x	0.416	0.402	0.396	0.410
	y	0.389	0.382	0.367	0.374

Tolerance: ± 0.01

Neutral White	Color Limits (Chromaticity Coordinates)				
		x	y	z	u
Bin RM	x	0.421	0.414	0.397	0.402
	y	0.433	0.414	0.406	0.423
Bin R1	x	0.414	0.409	0.392	0.397
	y	0.414	0.400	0.391	0.406
Bin R0	x	0.392	0.387	0.402	0.409
	y	0.391	0.374	0.382	0.400
Bin RA	x	0.387	0.383	0.396	0.402
	y	0.374	0.360	0.367	0.382
Bin SM	x	0.402	0.397	0.382	0.386
	y	0.423	0.406	0.397	0.413
Bin S1	x	0.397	0.392	0.378	0.382
	y	0.406	0.391	0.382	0.397
Bin S0	x	0.392	0.387	0.374	0.378
	y	0.391	0.374	0.366	0.382
Bin SA	x	0.387	0.383	0.370	0.374
	y	0.374	0.360	0.351	0.366
Bin TM	x	0.386	0.382	0.365	0.367
	y	0.413	0.397	0.386	0.400
Bin S0	x	0.392	0.387	0.374	0.378
	y	0.391	0.374	0.366	0.382
Bin TN	x	0.382	0.378	0.362	0.365
	y	0.397	0.382	0.372	0.386
Bin T0	x	0.378	0.374	0.360	0.362
	y	0.382	0.366	0.357	0.372
Bin TP	x	0.374	0.370	0.357	0.360
	y	0.366	0.351	0.342	0.357

Tolerance: ± 0.01

Packaging Option (x_6)

Selection	Option
1	Tape and Reel

Example

ASMT-JW32-NWY01

ASMT-JW32-Nxxxx – Cool White, InGaN, Electrically isolated Heat Sink

- $x_3 = W$ – Minimum Flux Bin W
- $x_4 = Y$ – Maximum Flux Bin Y
- $x_5 = 0$ – Full Distribution
- $x_6 = 1$ – Tape and Reel Option

Figure 5 Relative Intensity vs. Wavelength for Cool White, Neutral White, and Warm White

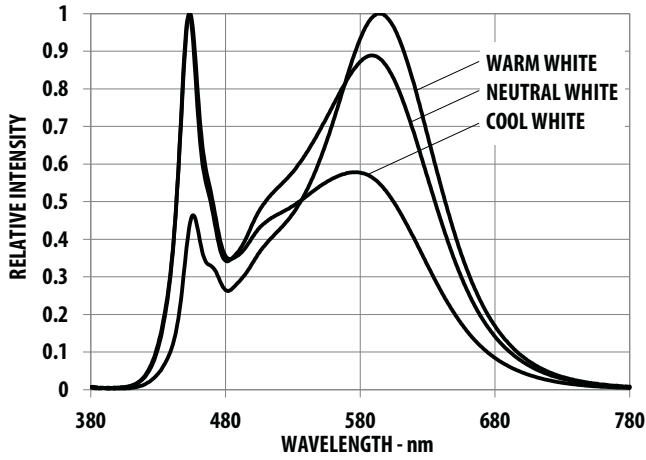

Figure 6 Relative Luminous Flux vs. Mono Pulse Current

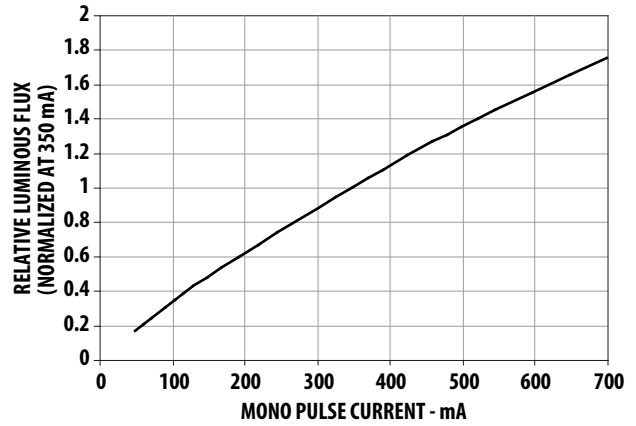

Figure 7 Forward Current vs. Forward Voltage

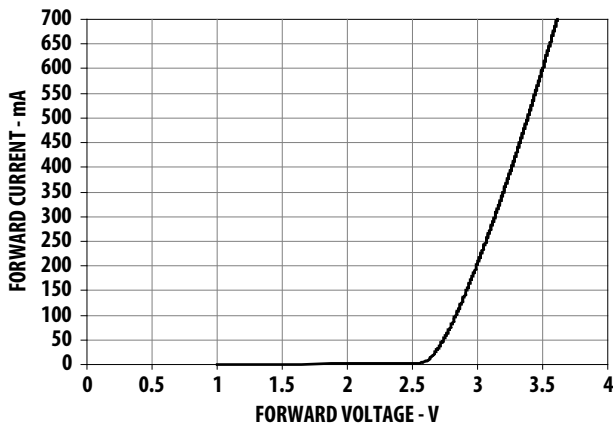

Figure 8 Maximum Pulse Current vs. Pulse Duration. Derated based on $T_A = 25^\circ\text{C}$, $R_{\theta J-A} = 30^\circ\text{C/W}$.

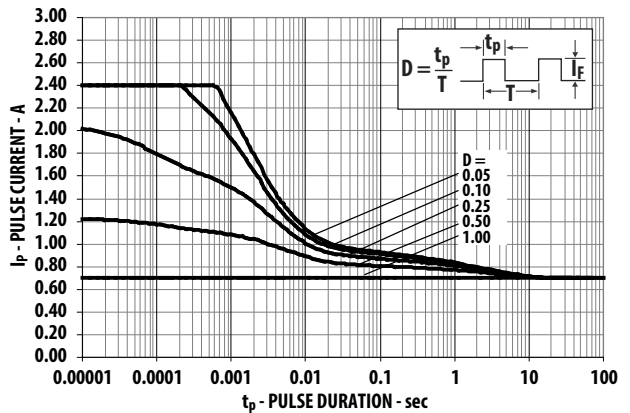

Figure 9 Maximum Pulse Current vs. Pulse Duration. Derated based on $T_A = 85^\circ\text{C}$, $R_{\theta J-A} = 30^\circ\text{C/W}$.

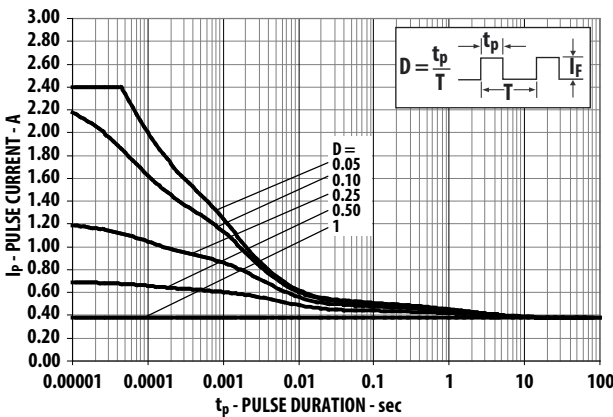

Figure 10 Radiation Pattern for Cool White, Warm White, and Neutral White

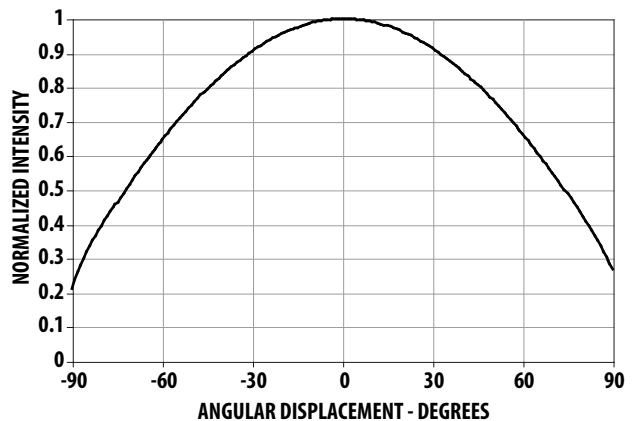

Figure 11 Relative Light Output vs. Junction Temperature

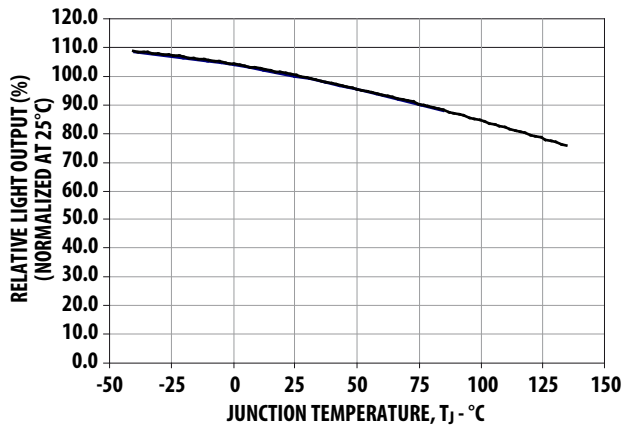

Figure 12 Forward Voltage Shift vs. Junction Temperature

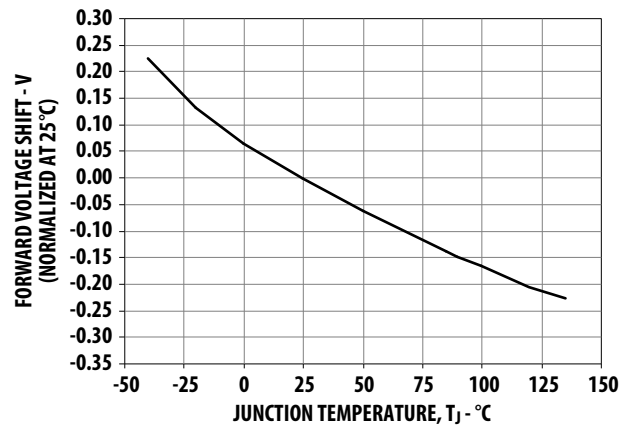

Figure 13 Maximum Forward Current vs. Ambient Temperature. Derated based on $T_{JMAX} = 125^\circ\text{C}$, $R_{\theta J-A} = 20^\circ\text{C/W}$, 25°C/W , and 30°C/W .

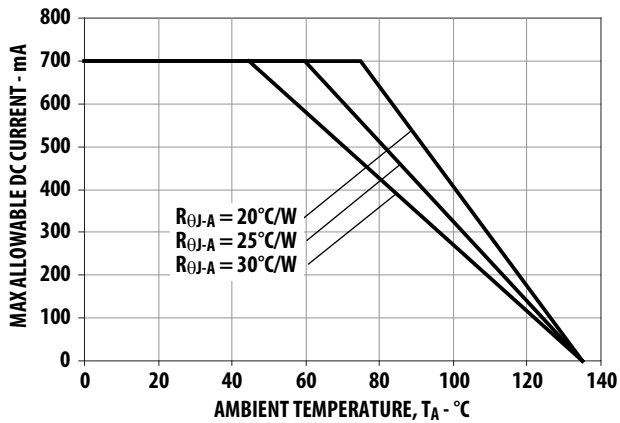

Figure 14 Maximum Forward Current vs. Metal Slug Temperature. Derated based on $T_{JMAX} = 125^\circ\text{C}$, $R_{\theta J-MS} = 9^\circ\text{C/W}$.

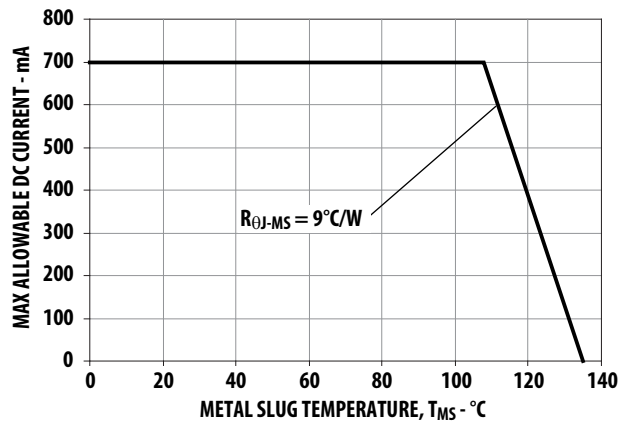

Figure 15 Recommended Soldering Land Pattern

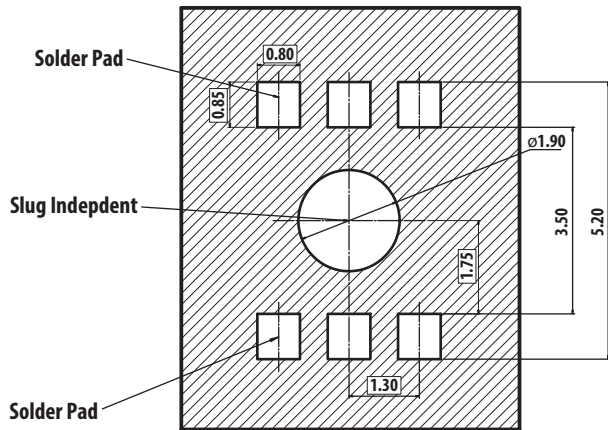

Figure 16 Recommended Pick and Place Nozzle Tip. Inner diameter = 3.2 mm.

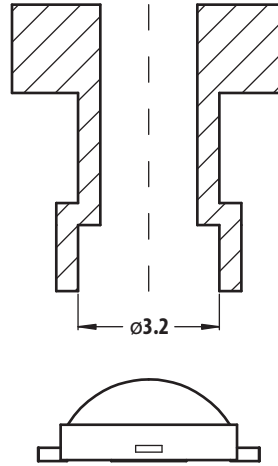
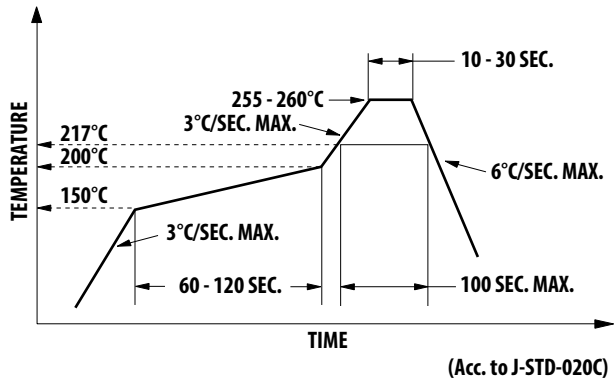

Figure 17 Recommended Soldering Profile



NOTE For detailed information on reflow soldering of Broadcom surface-mount LEDs, refer to Broadcom Application Note AN1060, *Surface Mounting SMT LED Indicator Components*.

Tape and Reel – Option 1

Figure 18 Carrier Tape Dimensions

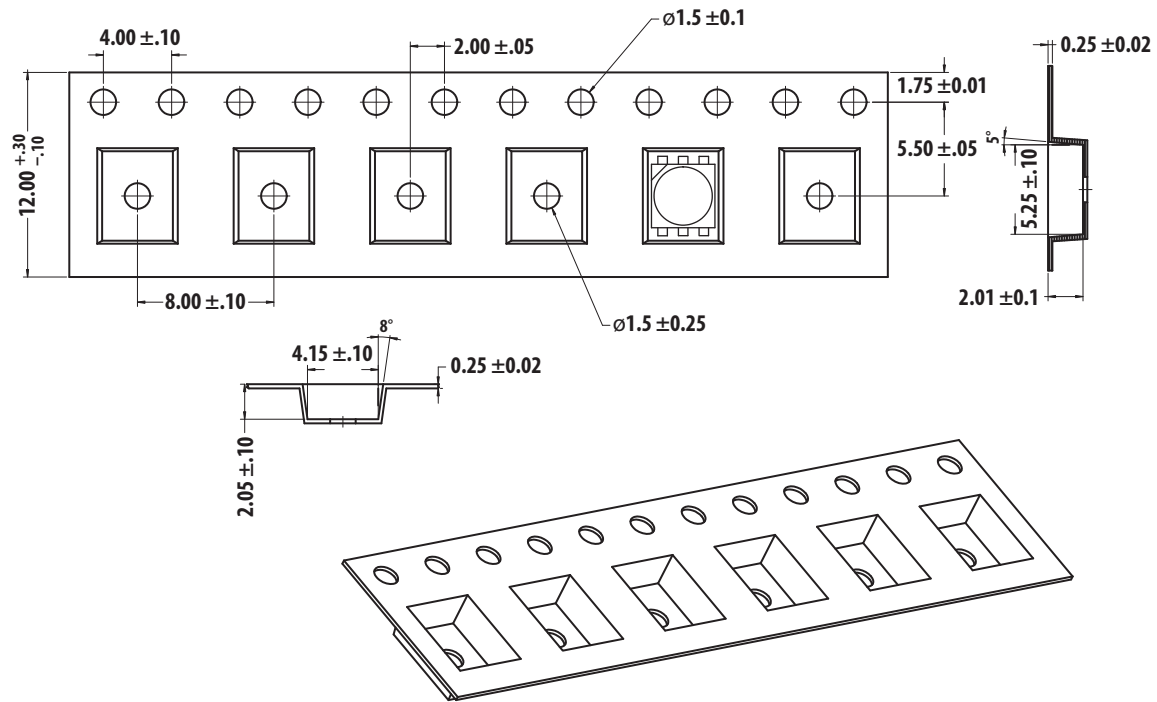

NOTE All dimensions are in millimeters.

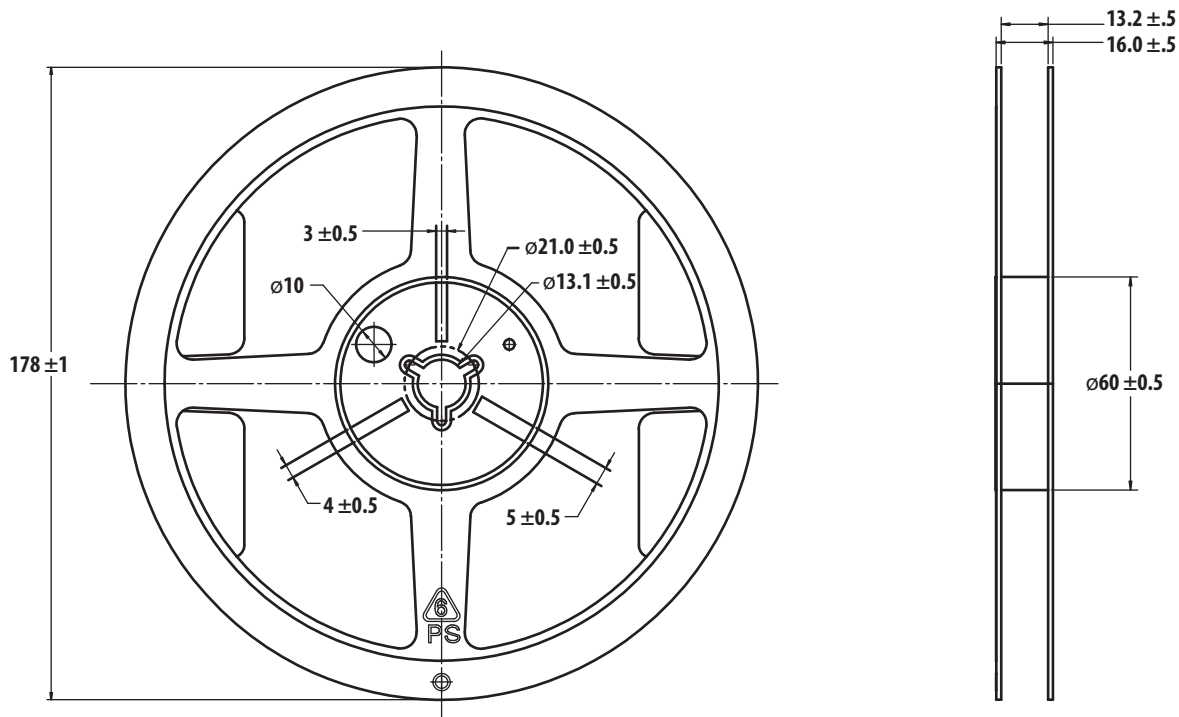
Figure 19 Reel Dimensions**NOTE**

1. Empty component pockets sealed with top cover tape.
2. 250 or 500 pieces per reel.
3. Drawing not to scale.
4. All dimensions are in millimeters.

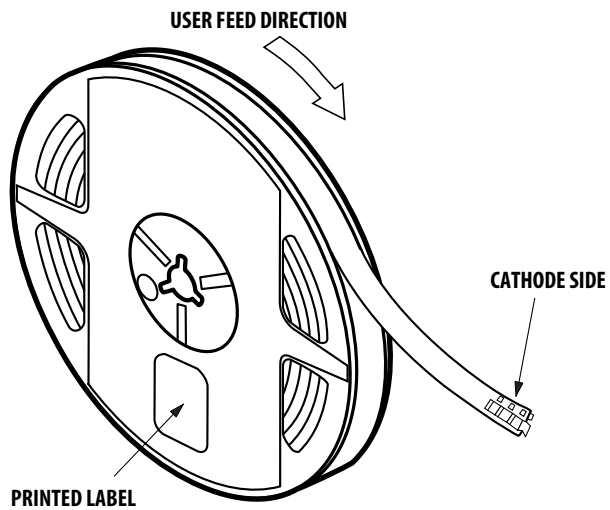
Figure 20 Reeling Orientation

DISCLAIMER: Broadcom's products and software are not specifically designed, manufactured, or authorized for sale as parts, components, or assemblies for the planning, construction, maintenance, or direct operation of a nuclear facility or for use in medical devices or applications. The customer is solely responsible, and waives all rights to make claims against Broadcom or its suppliers, for all loss, damage, expense, or liability in connection with such use.

For product information and a complete list of distributors, please go to our web site: www.broadcom.com.

Broadcom, the pulse logo, Connecting everything, Avago Technologies, Avago, and the A logo are among the trademarks of Broadcom and/or its affiliates in the United States, certain other countries and/or the EU.

Copyright © 2015–2017 by Broadcom. All Rights Reserved.

The term "Broadcom" refers to Broadcom Limited and/or its subsidiaries. For more information, please visit www.broadcom.com.

Broadcom reserves the right to make changes without further notice to any products or data herein to improve reliability, function, or design.

Information furnished by Broadcom is believed to be accurate and reliable. However, Broadcom does not assume any liability arising out of the application or use of this information, nor the application or use of any product or circuit described herein, neither does it convey any license under its patent rights nor the rights of others.

AV02-2428EN – April 24, 2017



Mouser Electronics

Authorized Distributor

Click to View Pricing, Inventory, Delivery & Lifecycle Information:

Broadcom Limited:

[ASMT-JN32-NVVG1](#) [ASMT-JN32-NVVH1](#) [ASMT-JW32-NVVH1](#) [ASMT-JW32-NVVJ1](#) [ASMT-JW32-NVVK1](#) [ASMT-JY32-NTVH1](#) [ASMT-JY32-NTVJ1](#) [ASMT-JY32-NTVK1](#) [ASMT-JN32-NVW01](#) [ASMT-JN32-NWX01](#) [ASMT-JN32-NWXG1](#) [ASMT-JN32-NWXH1](#) [ASMT-JW32-NVW01](#) [ASMT-JW32-NWX01](#) [ASMT-JW32-NWXH1](#) [ASMT-JW32-NWXJ1](#) [ASMT-JW32-NWXK1](#) [ASMT-JY32-NUW01](#) [ASMT-JY32-NUWH1](#) [ASMT-JY32-NUWJ1](#) [ASMT-JY32-NUWK1](#) [ASMT-JW32-NUV01](#) [ASMT-JY32-NTV01](#) [ASMT-JN32-NVV01](#) [ASMT-JW32-NVV01](#) [ASMT-JY32-NWY01](#) [ASMT-JW32-NWY01](#) [ASMT-JN32-NWY01](#)