

# MC 1,5/ 8-G-3,5 - PCB header



1844278

<https://www.phoenixcontact.com/us/products/1844278>

Please be informed that the data shown in this PDF document is generated from our online catalog. Please find the complete data in the user documentation. Our general terms of use for downloads are valid.

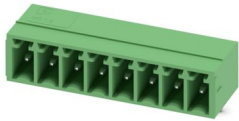

PCB headers, nominal cross section: 1.5 mm<sup>2</sup>, color: green, nominal current: 8 A, rated voltage (III/2): 160 V, contact surface: Tin, contact connection type: Pin, number of potentials: 8, number of rows: 1, number of positions: 8, number of connections: 8, product range: MC 1,5/...-G, pitch: 3.5 mm, mounting: Wave soldering, pin layout: Linear pinning, solder pin [P]: 3.4 mm, number of solder pins per potential: 1, plug-in system: COMBICON MC 1,5, Pin connector pattern alignment: Standard, locking: without, mounting: without, type of packaging: packed in cardboard

## Your advantages

- Well-known mounting principle allows worldwide use
- Maximum flexibility when it comes to device design – one header for connectors with different connection technologies

## Commercial data

Item number	1844278
Packing unit	100 pc
Minimum order quantity	100 pc
Sales key	AA02
Product key	AABSAA
Catalog page	Page 224 (C-1-2013)
GTIN	4017918113315
Weight per piece (including packing)	2.133 g
Weight per piece (excluding packing)	2 g
Customs tariff number	85366930
Country of origin	DE

# MC 1,5/ 8-G-3,5 - PCB header



1844278

<https://www.phoenixcontact.com/us/products/1844278>

## Technical data

### Product properties

Product type	PCB headers
Product family	MC 1,5/..-G
Product line	COMBICON Connectors S
Type	Standard
Number of positions	8
Pitch	3.5 mm
Number of connections	8
Number of rows	1
Number of potentials	8
Mounting flange	without
Pin layout	Linear pinning
Solder pins per potential	1

### Electrical properties

Nominal current $I_N$	8 A
Nominal voltage $U_N$	160 V
Degree of pollution	3
Contact resistance	1.3 m $\Omega$
Rated voltage (III/3)	160 V
Rated surge voltage (III/3)	2.5 kV
Rated voltage (III/2)	160 V
Rated surge voltage (III/2)	2.5 kV
Rated voltage (II/2)	250 V
Rated surge voltage (II/2)	2.5 kV

### Mounting

Mounting type	Wave soldering
Pin layout	Linear pinning

### Material specifications

#### Material data - contact

Note	WEEE/RoHS-compliant, free of whiskers according to IEC 60068-2-82/JEDEC JESD 201
Contact material	Cu alloy
Surface characteristics	Tin-plated
Metal surface contact area (top layer)	Tin (3 - 5 $\mu\text{m}$ Sn)
Metal surface contact area (middle layer)	Nickel (1.3 - 3 $\mu\text{m}$ Ni)
Metal surface soldering area (top layer)	Tin (3 - 5 $\mu\text{m}$ Sn)
Metal surface soldering area (middle layer)	Nickel (1.3 - 3 $\mu\text{m}$ Ni)

#### Material data - housing

# MC 1,5/ 8-G-3,5 - PCB header

1844278

<https://www.phoenixcontact.com/us/products/1844278>

Color (Housing)	green (6021)
Insulating material	PBT
Insulating material group	IIIa
CTI according to IEC 60112	225
Flammability rating according to UL 94	V0

## Dimensions

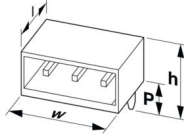
Dimensional drawing	
Pitch	3.5 mm
Width [w]	29.4 mm
Height [h]	10.65 mm
Length [l]	9.2 mm
Installed height	7.25 mm
Solder pin length [P]	3.4 mm
Pin dimensions	0.8 x 0.8 mm

## PCB design

Hole diameter	1.2 mm
---------------	--------

## Mechanical tests

### Visual inspection

Specification	IEC 60512-1-1:2002-02
Result	Test passed

### Dimension check

Specification	IEC 60512-1-2:2002-02
Result	Test passed

### Resistance of inscriptions

Specification	IEC 60068-2-70:1995-12
Result	Test passed

### Polarization and coding

Specification	IEC 60512-13-5:2006-02
Result	Test passed

### Contact holder in insert

Specification	IEC 60512-15-1:2008-05
Contact holder in insert Requirements >20 N	Test passed

### Insertion and withdrawal forces

# MC 1,5/ 8-G-3,5 - PCB header



1844278

<https://www.phoenixcontact.com/us/products/1844278>

Result	Test passed
No. of cycles	25
Insertion strength per pos. approx.	6 N
Withdraw strength per pos. approx.	4 N

## Electrical tests

### Thermal test | Test group C

Specification	IEC 60512-5-1:2002-02
Tested number of positions	20

### Insulation resistance

Specification	IEC 60512-3-1:2002-02
Insulation resistance, neighboring positions	> 5 MΩ

### Air clearances and creepage distances |

Specification	IEC 60664-1:2007-04
Insulating material group	IIIa
Comparative tracking index (IEC 60112)	CTI 225
Rated insulation voltage (III/3)	160 V
Rated surge voltage (III/3)	2.5 kV
minimum clearance value - non-homogenous field (III/3)	1.5 mm
minimum creepage distance (III/3)	2.5 mm
Rated insulation voltage (III/2)	160 V
Rated surge voltage (III/2)	2.5 kV
minimum clearance value - non-homogenous field (III/2)	1.5 mm
minimum creepage distance (III/2)	1.6 mm
Rated insulation voltage (II/2)	250 V
Rated surge voltage (II/2)	2.5 kV
minimum clearance value - non-homogenous field (II/2)	1.5 mm
minimum creepage distance (II/2)	2.5 mm

## Environmental and real-life conditions

### Vibration test

Specification	IEC 60068-2-6:2007-12
Frequency	10 - 150 - 10 Hz
Sweep speed	1 octave/min
Amplitude	0.35 mm (10 Hz ... 60.1 Hz)
Sweep speed	5g (60.1 Hz ... 150 Hz)
Test duration per axis	2.5 h

### Durability test

Specification	IEC 60512-9-1:2010-03
Impulse withstand voltage at sea level	2.95 kV
Contact resistance R <sub>1</sub>	1.3 mΩ

# MC 1,5/ 8-G-3,5 - PCB header



1844278

<https://www.phoenixcontact.com/us/products/1844278>

Contact resistance $R_2$	1.4 m $\Omega$
Insertion/withdrawal cycles	25
Insulation resistance, neighboring positions	> 5 M $\Omega$

## Climatic test

Specification	ISO 6988:1985-02
Corrosive stress	0.2 dm <sup>3</sup> SO <sub>2</sub> on 300 dm <sup>3</sup> /40 °C/1 cycle
Thermal stress	100 °C/168 h
Power-frequency withstand voltage	1.39 kV

## Ambient conditions

Ambient temperature (operation)	-40 °C ... 100 °C (dependent on the derating curve)
Ambient temperature (storage/transport)	-40 °C ... 70 °C
Relative humidity (storage/transport)	30 % ... 70 %
Ambient temperature (assembly)	-5 °C ... 100 °C

## Packaging specifications

Type of packaging	packed in cardboard
-------------------	---------------------

# MC 1,5/ 8-G-3,5 - PCB header

1844278

<https://www.phoenixcontact.com/us/products/1844278>

## Drawings

Diagram

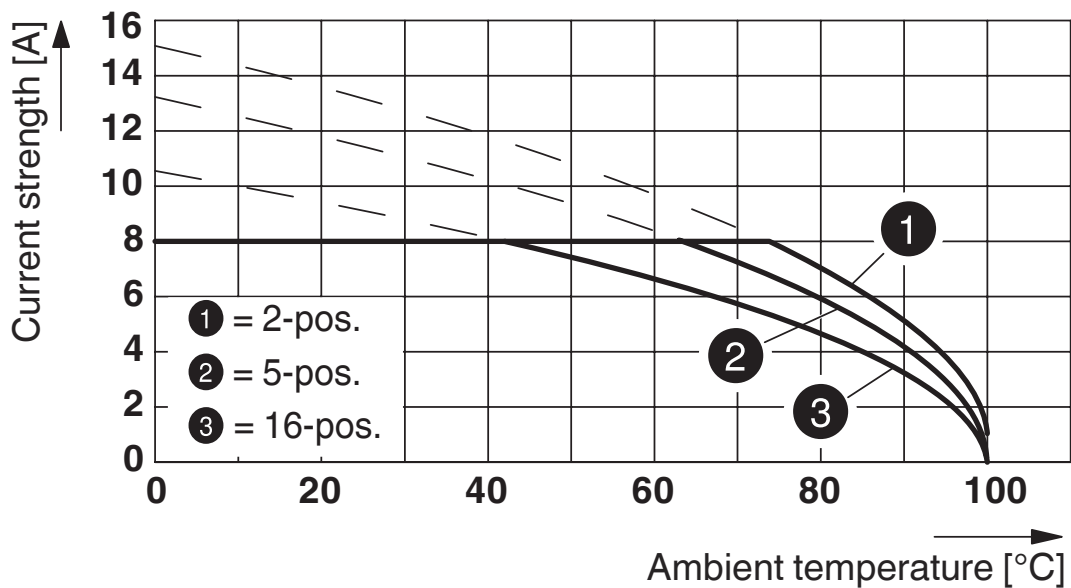

Type: MCVW 1,5/...-ST-3,5 with MC 1,5/...-G-3,5

Dimensional drawing

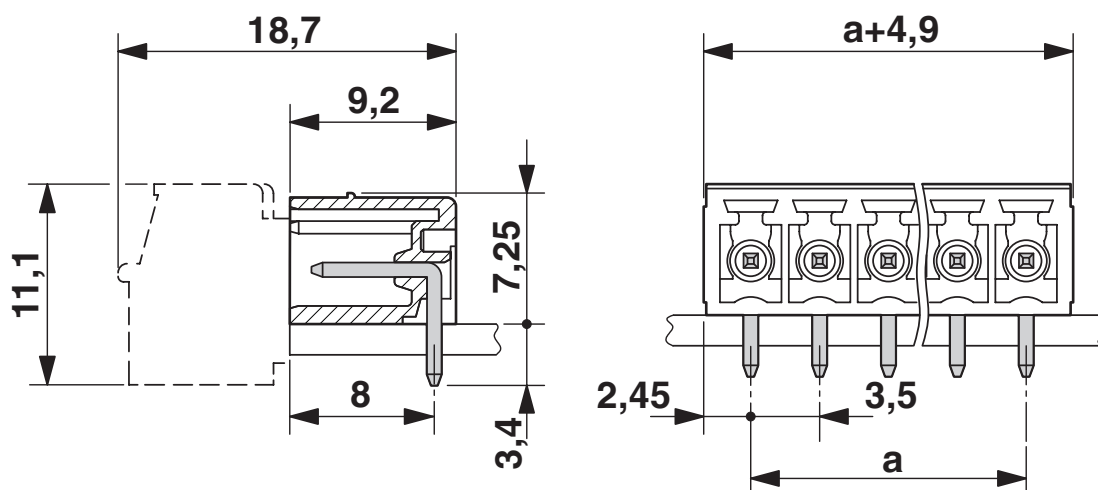

# MC 1,5/ 8-G-3,5 - PCB header

1844278

<https://www.phoenixcontact.com/us/products/1844278>

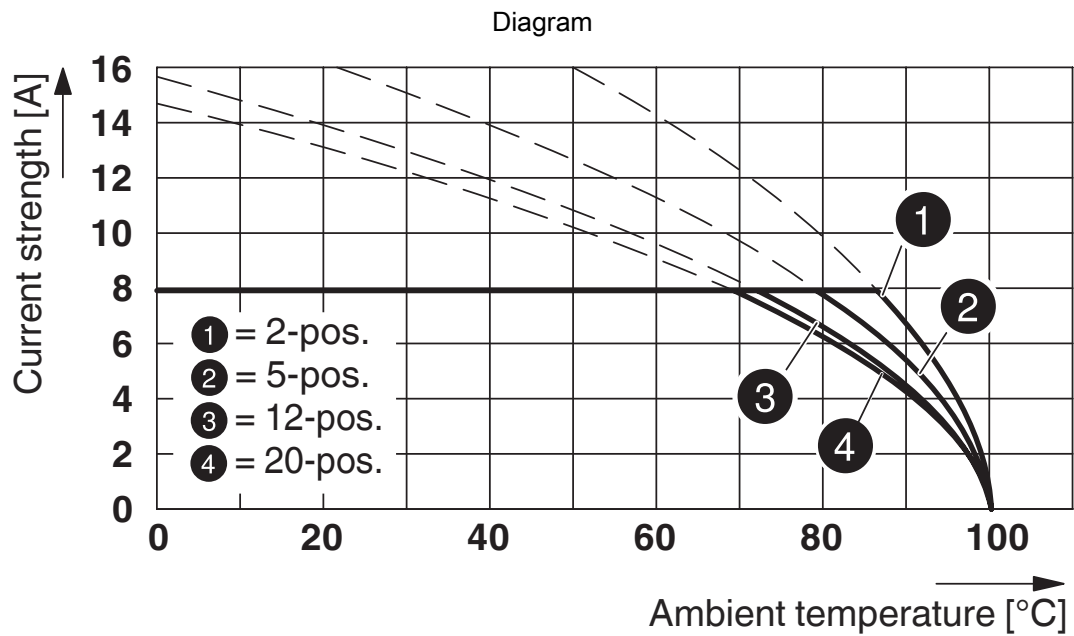

Type: MC 1,5/...-ST-3,5 with MC 1,5/...-G-3,5

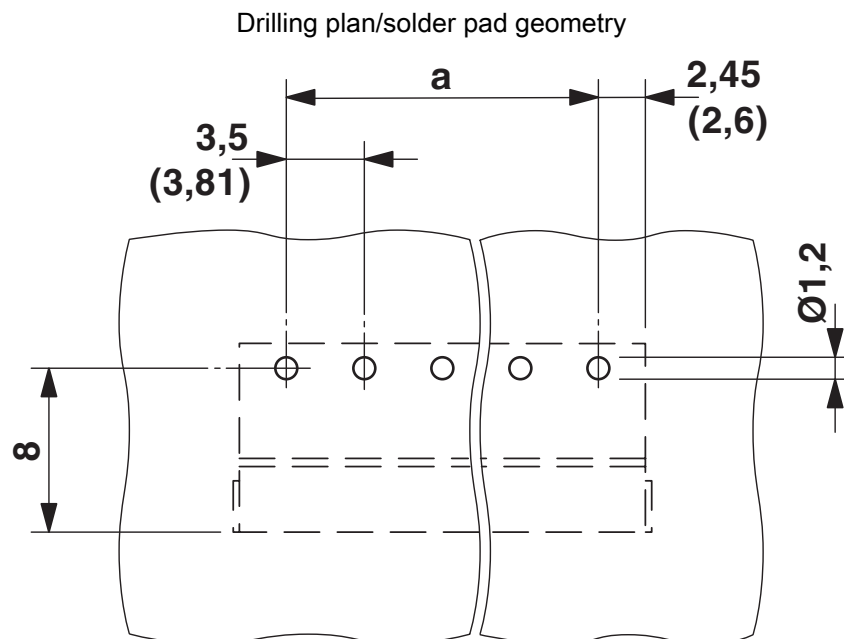

# MC 1,5/ 8-G-3,5 - PCB header



1844278

<https://www.phoenixcontact.com/us/products/1844278>

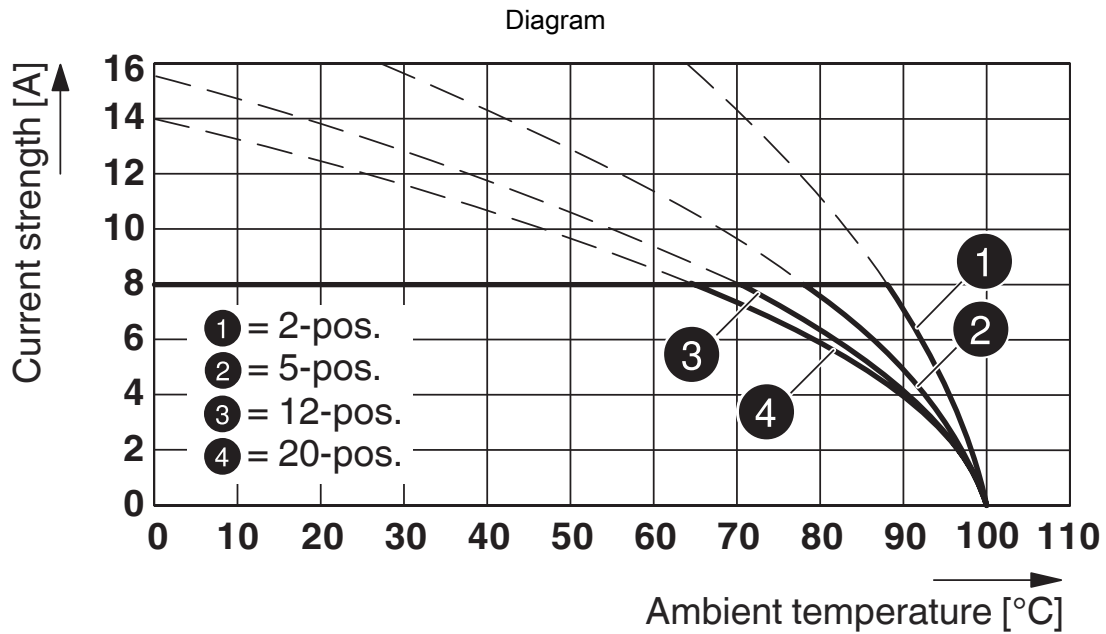

Type: FK-MCP 1,5/...-ST-3,5 with MC 1,5/...-G-3,5

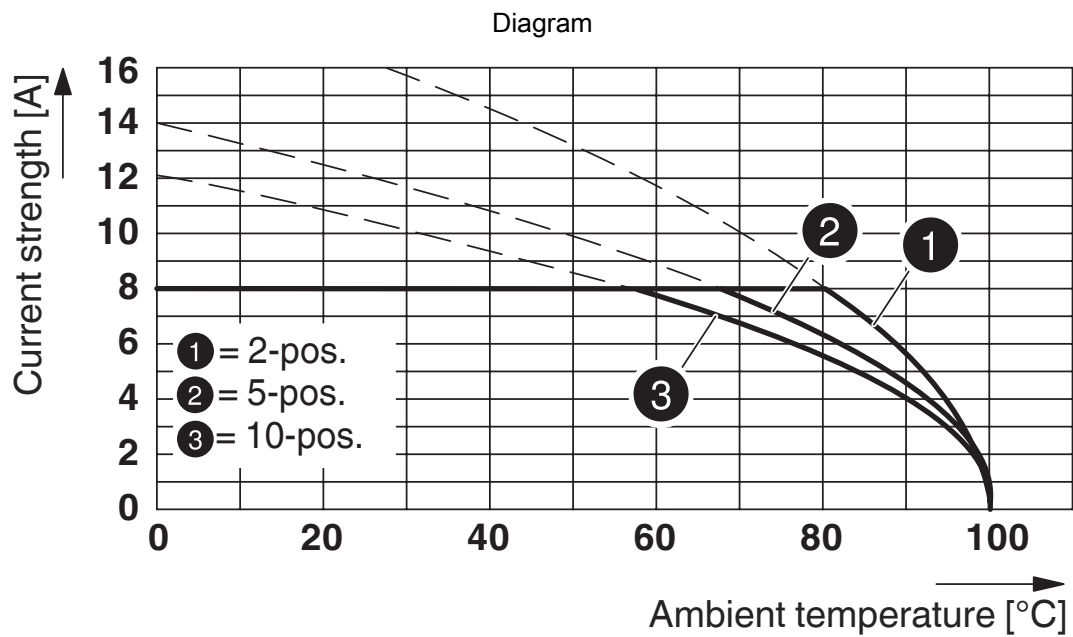

Type: TFMC 1,5/...-ST-3,5 with MC 1,5/...-G-3,5



# MC 1,5/ 8-G-3,5 - PCB header





1844278

<https://www.phoenixcontact.com/us/products/1844278>

## Approvals

To download certificates, visit the product detail page: <https://www.phoenixcontact.com/us/products/1844278>

 <b>VDE Zeichengenehmigung</b> Approval ID: 40057836				
	Nominal voltage $U_N$	Nominal current $I_N$	Cross section AWG	Cross section $\text{mm}^2$
	160 V	8 A	-	-

 <b>CSA</b> Approval ID: 13631				
	Nominal voltage $U_N$	Nominal current $I_N$	Cross section AWG	Cross section $\text{mm}^2$
Use group B	300 V	8 A	-	-
Use group D	300 V	8 A	-	-

 <b>cULus Recognized</b> Approval ID: E60425-20110128				
	Nominal voltage $U_N$	Nominal current $I_N$	Cross section AWG	Cross section $\text{mm}^2$
Use group B	300 V	8 A	-	-
Use group D	300 V	8 A	-	-

 <b>VDE Zeichengenehmigung</b> Approval ID: 40011723				
	Nominal voltage $U_N$	Nominal current $I_N$	Cross section AWG	Cross section $\text{mm}^2$
	160 V	8 A	-	-

# MC 1,5/ 8-G-3,5 - PCB header



1844278

<https://www.phoenixcontact.com/us/products/1844278>

## Classifications

### ECLASS

ECLASS-11.0	27460201
ECLASS-12.0	27460201
ECLASS-13.0	27460201

### ETIM

ETIM 9.0	EC002637
----------	----------

### UNSPSC

UNSPSC 21.0	39121400
-------------	----------

# MC 1,5/ 8-G-3,5 - PCB header

1844278

<https://www.phoenixcontact.com/us/products/1844278>



## Environmental product compliance

### EU RoHS

Fulfills EU RoHS substance requirements	Yes, No exemptions
---	--------------------

### China RoHS

Environment friendly use period (EFUP)	EFUP-E
	No hazardous substances above the limits

### EU REACH SVHC

REACH candidate substance (CAS No.)	No substance above 0.1 wt%
-------------------------------------	----------------------------

# MC 1,5/ 8-G-3,5 - PCB header

1844278

<https://www.phoenixcontact.com/us/products/1844278>



## Accessories

### SK 3,5/2,8:FORTL.ZAHLEN - Marker card

0804073

<https://www.phoenixcontact.com/us/products/0804073>



Marker card, Sheet, white, labeled, horizontal: consecutive numbers 1 ... 10, 11 .. 20, etc. up to 91 ... 99, mounting type: adhesive, for terminal block width: 3.5 mm, lettering field size: 3.5 x 2.8 mm, Number of individual labels: 14

---

### CP-MSTB - Coding profile

1734634

<https://www.phoenixcontact.com/us/products/1734634>



Coding profile, is inserted into the slot on the plug or inverted header, red insulating material

## MC 1,5/ 8-G-3,5 - PCB header

1844278

<https://www.phoenixcontact.com/us/products/1844278>



### MC 1,5/10-LWL 1,5-3,5 - Fiber optic

1841161

<https://www.phoenixcontact.com/us/products/1841161>

MINI COMBICON fiber optics, 3.5 mm pitch, 10-pos., separable for other numbers of positions (minimum: 2-pos.), inserts into the back of the MC header, color: transparent, dimension a: 1.5 mm



---

### MC 1,5/10-LWL 2,3-3,5 - Fiber optic

1841187

<https://www.phoenixcontact.com/us/products/1841187>

MINI COMBICON fiber optics, 3.5 mm pitch, 10-pos., separable for other numbers of positions (minimum: 2-pos.), inserts into the back of the MC header, color: transparent, dimension a: 2.3 mm



# MC 1,5/ 8-G-3,5 - PCB header

1844278

<https://www.phoenixcontact.com/us/products/1844278>



## MC 1,5/10-LWL 4-3,5 - Fiber optic

1841200

<https://www.phoenixcontact.com/us/products/1841200>

MINI COMBICON fiber optics, 3.5 mm pitch, 10-pos., separable for other numbers of positions (minimum: 2-pos.), inserts into the back of the MC header, color: transparent, dimension a: 4 mm



---

## TFMC 1,5/ 8-ST-3,5 - Printed-circuit board connector

1772676

<https://www.phoenixcontact.com/us/products/1772676>

PCB connector, nominal cross section: 1.5 mm<sup>2</sup>, color: green, nominal current: 8 A, rated voltage (III/2): 160 V, contact surface: Tin, contact connection type: Socket, number of potentials: 8, number of rows: 1, number of positions: 8, number of connections: 16, product range: TFMC 1,5/..-ST, pitch: 3.5 mm, connection method: Push-in spring connection, conductor/PCB connection direction: 0 °, plug-in system: COMBICON MC 1,5, locking: without, mounting: without, type of packaging: packed in cardboard

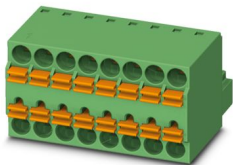

## MC 1,5/ 8-G-3,5 - PCB header

1844278

<https://www.phoenixcontact.com/us/products/1844278>



## MC 1,5/ 8-ST-3,5 - PCB connector

1840421

<https://www.phoenixcontact.com/us/products/1840421>

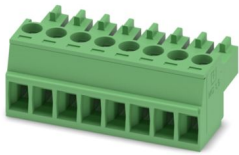

PCB connector, nominal cross section: 1.5 mm<sup>2</sup>, color: green, nominal current: 8 A, rated voltage (III/2): 160 V, contact surface: Tin, contact connection type: Socket, number of potentials: 8, number of rows: 1, number of positions: 8, number of connections: 8, product range: MC 1,5/...-ST, pitch: 3.5 mm, connection method: Screw connection with tension sleeve, screw head form: L Slotted, conductor/PCB connection direction: 0 °, plug-in system: COMBICON MC 1,5, locking: without, mounting: without, type of packaging: packed in cardboard

---

## MCVW 1,5/ 8-ST-3,5 - PCB connector

1862917

<https://www.phoenixcontact.com/us/products/1862917>

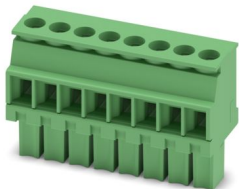

PCB connector, nominal cross section: 1.5 mm<sup>2</sup>, color: green, nominal current: 8 A, rated voltage (III/2): 160 V, contact surface: Tin, contact connection type: Socket, number of potentials: 8, number of rows: 1, number of positions: 8, number of connections: 8, product range: MCVW 1,5/...-ST, pitch: 3.5 mm, connection method: Screw connection with tension sleeve, screw head form: L Slotted, conductor/PCB connection direction: -90 °, plug-in system: COMBICON MC 1,5, locking: without, mounting: without, type of packaging: packed in cardboard

## MC 1,5/ 8-G-3,5 - PCB header

1844278

<https://www.phoenixcontact.com/us/products/1844278>



## MCVR 1,5/ 8-ST-3,5 - PCB connector

1863217

<https://www.phoenixcontact.com/us/products/1863217>

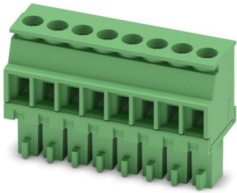

PCB connector, nominal cross section: 1.5 mm<sup>2</sup>, color: green, nominal current: 8 A, rated voltage (III/2): 160 V, contact surface: Tin, contact connection type: Socket, number of potentials: 8, number of rows: 1, number of positions: 8, number of connections: 8, product range: MCVR 1,5/...-ST, pitch: 3.5 mm, connection method: Screw connection with tension sleeve, screw head form: L Slotted, conductor/PCB connection direction: 90 °, plug-in system: COMBICON MC 1,5, locking: without, mounting: without, type of packaging: packed in cardboard

## FK-MCP 1,5/ 8-ST-3,5 - PCB connector

1939963

<https://www.phoenixcontact.com/us/products/1939963>

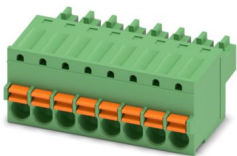

PCB connector, nominal cross section: 1.5 mm<sup>2</sup>, color: green, nominal current: 8 A, rated voltage (III/2): 160 V, contact surface: Tin, contact connection type: Socket, number of potentials: 8, number of rows: 1, number of positions: 8, number of connections: 8, product range: FK-MCP 1,5/...-ST, pitch: 3.5 mm, connection method: Push-in spring connection, conductor/PCB connection direction: 0 °, plug-in system: COMBICON MC 1,5, locking: without, mounting: without, type of packaging: packed in cardboard



# MC 1,5/ 8-G-3,5 - PCB header

1844278

<https://www.phoenixcontact.com/us/products/1844278>



## FMC 1,5/ 8-ST-3,5 - Printed-circuit board connector

1952322

<https://www.phoenixcontact.com/us/products/1952322>

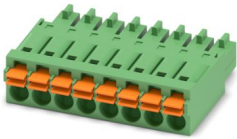

PCB connector, nominal cross section: 1.5 mm<sup>2</sup>, color: green, nominal current: 8 A, rated voltage (III/2): 160 V, contact surface: Tin, contact connection type: Socket, number of potentials: 8, number of rows: 1, number of positions: 8, number of connections: 8, product range: FMC 1,5/..-ST, pitch: 3.5 mm, connection method: Push-in spring connection, conductor/PCB connection direction: 0 °, plug-in system: COMBICON MC 1,5, locking: without, mounting: without, type of packaging: packed in cardboard

## XPC 1,5/ 8-ST-3,5 BK - PCB connector

1464111

<https://www.phoenixcontact.com/us/products/1464111>

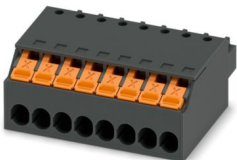

PCB connector, nominal cross section: 1.5 mm<sup>2</sup>, color: black, nominal current: 8 A, rated voltage (III/2): 160 V, contact surface: Tin, contact connection type: Socket, number of rows: 1, number of positions: 8, product range: XPC 1,5/..-ST, pitch: 3.5 mm, connection method: Push-X-connection, conductor/PCB connection direction: 0 °, locking clip: - without locking clip, plug-in system: COMBICON MC 1,5, locking: without, mounting: without, type of packaging: packed in cardboard

Phoenix Contact 2024 © - all rights reserved  
<https://www.phoenixcontact.com>

Phoenix Contact USA  
586 Fulling Mill Road  
Middletown, PA 17057, United States  
(+717) 944-1300  
[info@phoenixcon.com](mailto:info@phoenixcon.com)