

PRESSURE RELEASE

THE LATEST SALES SUPPORT NEWS FROM SALES ENGINEERING

Bulletin 27

26th March 2002

Fittings supplied by SMC that are not in the current catalogue.



Male/Male nipple

Flush plug

Part Number	Thread	Stock	Part Number	Thread	Stock
NIPPLE1/8(AC)	Taper	Kogo	PLUG1/16	Taper	Yes
NIPPLE1/4(AC)	Taper	Kogo	PLUG1/8	Taper	Kogo
NIPPLE3/8(AC)	Taper	Kogo	PLUG1/4	Taper	Kogo
NIPPLE1/2(AC)	Taper	Kogo	PLUG3/8	Taper	Kogo
NIPPLE3/4(AC)	Taper	Kogo	PLUG1/2	Taper	Kogo
			PLUG3/4	Taper	Kogo

Male/Male nipple (equal)

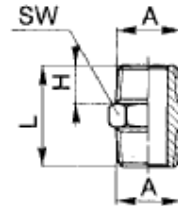

Part number	A	H	L	SW	Thread	Stock
2500-1/8	1/8	7.5	19.5	12	Taper	Kogo
2500-1/4	1/4	11	27	14	Taper	No
2500-3/8	3/8	11.5	28	17	Taper	Kogo
2500-1/2	1/2	14	33.5	22	Taper	No
2500-3/4	3/4	16.5	40	27	Taper	Yes

Male/Male nipple (equal)

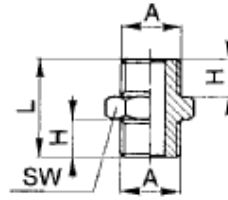

Part number	A	H	L	SW	Thread	Stock
2501-M5	M5	4	11.5	8	Parallel	Kogo
2501-1/8	1/8	6	16.5	14	Parallel	Kogo
2501-1/4	1/4	8	21	17	Parallel	Kogo
2501-3/8	3/8	9	23	19	Parallel	Kogo
2501-1/2	1/2	10	25.5	24	Parallel	Yes

Male/Male nipple (Different sizes)

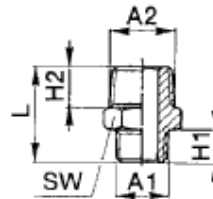

Part number	A1	A2	H1	H2	L	SW	Thread	Stock
2510-M5-1/8	M5	1/8	-	-	-	-	-	Kogo
2510-1/8-1/4	1/8	1/4	7.5	11	23.5	14	Taper	Kogo
2510-1/8-3/8	1/8	3/8	7.5	11.5	24	17	Taper	Kogo
2510-1/4-3/8	1/4	3/8	11	11.5	27.5	17	Taper	Kogo
2510-1/4-1/2	1/4	1/2	11	14	30.5	22	Taper	Kogo
2510-3/8-1/2	3/8	1/2	11.5	14	31	22	Taper	Kogo
2510-1/2-3/4	1/2	3/4	14	16.5	37.5	27	Taper	Kogo

Male/Male nipple (Different sizes)

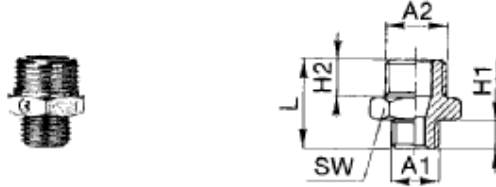

Part number	A1	A2	H1	H2	L	SW	Thread	Stock
2511-M5-1/8	M5	1/8	4	6	14.5	14	Parallel	Kogo
2511-1/8-1/4	1/8	1/4	6	8	19	17	Parallel	Kogo
2511-1/8-3/8	1/8	3/8	6	9	20	19	Parallel	Kogo
2511-1/4-3/8	1/4	3/8	8	9	22	19	Parallel	Kogo
2511-1/4-1/2	1/4	1/2	8	10	23.5	24	Parallel	Kogo
2511-3/8-1/2	3/8	1/2	9	10	24.5	24	Parallel	Kogo

Male/Female Bush (enlarging)



Part number	A	B	H	L	SW	Thread	Stock
2520-1/8-1/8	1/8	1/8	7.5	17.5	14	Taper	Kogo
2520-1/8-1/4	1/8	1/4	7.5	21.5	17	Taper	Kogo
2520-1/8-3/8	1/8	3/8	7.5	22	22	Taper	Kogo
2520-1/4-1/4	1/4	1/4	11	25	17	Taper	Kogo
2520-1/4-3/8	1/4	3/8	11	25.5	22	Taper	Kogo
2520-1/4-1/2	1/4	1/2	11	29	27	Taper	Kogo
2520-3/8-3/8	3/8	3/8	11.5	26	22	Taper	Kogo
2520-3/8-1/2	3/8	1/2	11.5	29.5	27	Taper	Kogo
2520-1/2-1/2	1/2	1/2	14	32	27	Taper	Kogo

Male/Female Bush (enlarging)



Part number	A	B	H	L	SW	Thread	Stock
2521-M5-1/8	M5	1/8	4	14	14	Parallel	Kogo
2521-1/8-1/8	1/8	1/8	6	16	14	Parallel	Kogo
2521-1/8-1/4	1/8	1/4	6	20	17	Parallel	Kogo
2521-1/8-3/8	1/8	3/8	6	20.5	22	Parallel	Kogo
2521-1/4-1/4	1/4	1/4	8	22	17	Parallel	Kogo
2521-1/4-3/8	1/4	3/8	8	22.5	22	Parallel	Kogo
2521-1/4-1/2	1/4	1/2	8	26	27	Parallel	Kogo
2521-3/8-3/8	3/8	3/8	9	23.5	22	Parallel	Kogo
2521-3/8-1/2	3/8	1/2	9	27	27	Parallel	Kogo
2521-1/2-1/2	1/2	1/2	10	28	27	Parallel	Kogo

Male/Female Bush (Reducing)



Part number	A	B	H	L	SW	Thread	Stock
2530-1/4-1/8	1/4	1/8	11	16	14	Taper	Kogo
2530-3/8-1/8	3/8	1/8	11.5	16.5	17	Taper	Kogo
2530-1/2-1/8	1/2	1/8	14	19.5	22	Taper	Kogo
2530-3/8-1/4	3/8	1/4	11.5	16.5	17	Taper	Kogo
2530-1/2-1/4	1/2	1/4	14	19.5	22	Taper	Kogo
2530-1/2-3/8	1/2	3/8	14	19.5	22	Taper	Kogo
2530-3/4-1/2	3/4	1/2	16.5	23.5	27	Taper	Yes

Male/Female Bush (Reducing)

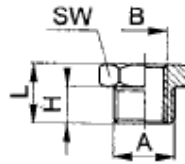

Part number	A	B	H	L	SW	Thread	Stock
2531-1/8-M5	1/8	M5	6	10.5	14	Parallel	Kogo
2531-1/4-1/8	1/4	1/8	8	13	17	Parallel	Kogo
2531-3/8-1/8	3/8	1/8	9	14	19	Parallel	Kogo
2531-1/2-1/8	1/2	1/8	10	15.5	24	Parallel	Kogo
2531-3/8-1/4	3/8	1/4	9	14	19	Parallel	Kogo
2531-1/2-1/4	1/2	1/4	10	15.5	24	Parallel	Kogo
2531-1/2-3/8	1/2	3/8	10	15.5	24	Parallel	Kogo

Female/Female union (equal)

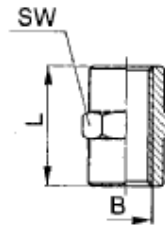

Part number	B	L	SW	Thread	Stock
2543-M5	M5	11	8	Parallel	Kogo
2543-1/8	1/8	15	14	Parallel	Kogo
2543-1/4	1/4	22	17	Parallel	Kogo
2543-3/8	3/8	24	22	Parallel	Kogo
2543-1/2	1/2	30	27	Parallel	Kogo

Female/Female union (not equal)



Part number	B1	B2	L	SW	Thread	Stock
2553-M5-1/8	M5	1/8	13	14	Parallel	List
2553-1/8-1/4	1/8	1/4	19.5	17	Parallel	Kogo
2553-1/8-3/8	1/8	3/8	20	22	Parallel	Kogo
2553-1/8-1/2	1/8	1/2	23.5	27	Parallel	Yes
2553-1/4-3/8	1/4	3/8	23	22	Parallel	Kogo
2553-1/4-1/2	1/4	1/2	27	27	Parallel	Yes
2553-3/8-1/2	3/8	1/2	27.5	27	Parallel	Kogo

Male/Female extension union

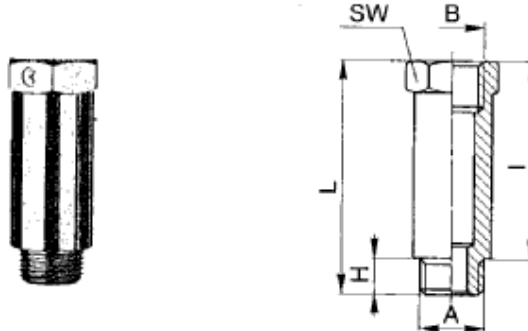

Part number	A	B	H	I	L	SW	Thread	Stock
2525-1/8-1/8-16	1/8	1/8	6	16	22	14	Parallel	Yes
2525-1/8-1/8-36	1/8	1/8	6	36	42	14	Parallel	Kogo
2525-1/4-1/4-27	1/4	1/4	8	27	35	17	Parallel	Kogo
2525-1/4-1/4-43	1/4	1/4	8	43	51	17	Parallel	Kogo

Plug

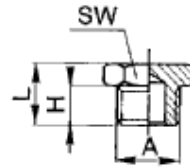

Part number	A	H	L	SW	Thread	Stock
2611-M5	M5	4	7.5	8	Parallel	Kogo
2611-1/8	1/8	6	10.5	14	Parallel	Kogo
2611-1/4	1/4	8	13	17	Parallel	Kogo
2611-3/8	3/8	9	14	19	Parallel	Kogo
2611-1/2	1/2	10	15.5	24	Parallel	Yes

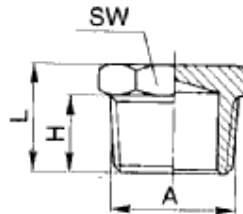

Part number	A	H	L	SW	Thread	Stock
2610-3/4	3/4	16.5	23	27	Taper	Y

Female plug

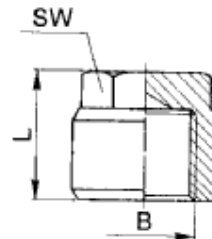

Part number	B	L	SW	Thread	Stock
2613-1/8	1/8	11	12	Parallel	Kogo
2613-1/4	1/4	19	14	Parallel	Kogo
2613-3/8	3/8	20	17	Parallel	Kogo
2613-1/2	1/2	22	17	Parallel	Kogo

Male hose tail fitting

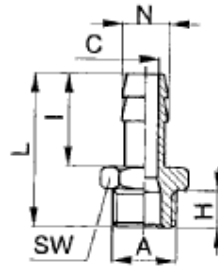

Part No	N	A	C	H	I	L	SW	Thread	Stock
2601-2-M5	2	M5	1.2	4	8	16	8	Parallel	Kogo
2601-4.5-M5	4.5	M5	2.5	4	15	23	8	Parallel	Kogo
2601-7-1/8	7	1/8	4	6	20	30	12	Parallel	Yes
2601-7-1/4	7	1/4	4	8	20	33	17	Parallel	Yes
2601-8-1/8	8	1/8	5	6	20	30	12	Parallel	List
2601-9-1/8	9	1/8	6	6	20	30	12	Parallel	Yes
2601-9-1/4	9	1/4	6	8	20	33	17	Parallel	Kogo
2601-9-3/8	9	3/8	6	9	20	34	19	Parallel	Yes
2601-12-1/4	12	1/4	9	8	20	33	17	Parallel	Kogo
2601-12-3/8	12	3/8	9	9	20	34	19	Parallel	Yes
2601-12-1/2	12	1/2	9	10	22	37.5	24	Parallel	Kogo
2601-17-3/8	17	3/8	13	9	24	38	19	Parallel	List
2601-17-1/2	17	1/2	13	10	24	39.5	24	Parallel	List

Male equal T

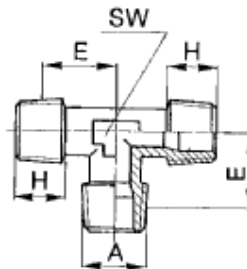
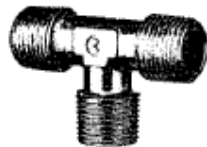

Part number	A	E	H	SW	Thread	Stock
2080-1/8	1/8	14	7.5	9	Taper	Kogo
2080-1/4	1/4	15.5	11	12	Taper	Kogo
2080-3/8	3/8	19.5	11.5	14	Taper	Kogo
2080-1/2	1/2	21.5	14	16	Taper	Kogo

Female/Male equal T

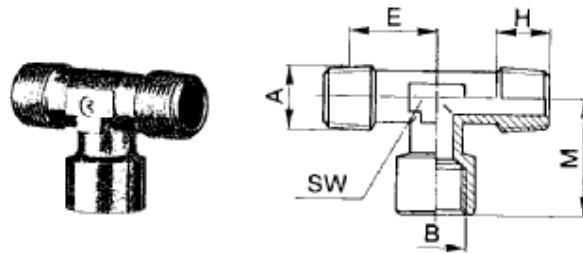

Part number	A	B	E	H	M	SW	Thread	Stock
2090-1/8-1/8	1/8	1/8	14	7.5	21	12	Taper	Kogo
2090-1/4-1/4	1/4	1/4	15.5	11	25.5	14	Taper	Kogo
2090-3/8-3/8	3/8	3/8	19.5	11.5	28	16	Taper	Kogo
2090-1/2-1/2	1/2	1/2	21.5	14	33	21	Taper	Kogo

Female equal T

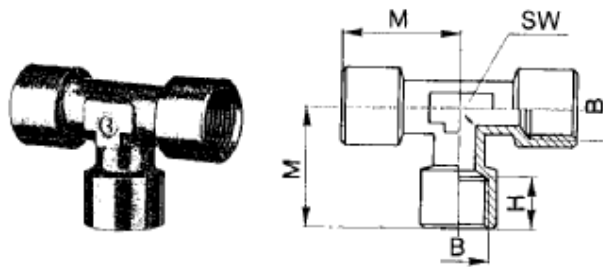

Part number	B	H	M	SW	Thread	Stock
2003-1/8	1/8	7.5	21	12	Parallel	Kogo
2003-1/4	1/4	11	25.5	14	Parallel	Kogo
2003-3/8	3/8	11.5	28	16	Parallel	Kogo
2003-1/2	1/2	15	33	21	Parallel	Kogo

Male/female equal T

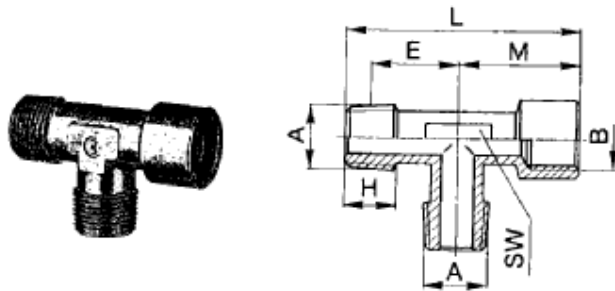

Part No	A	B	E	H	L	M	SW	Thread	Stock
2050-1/8	1/8	1/8	15	7.5	39.5	21	12	Taper	Kogo
2050-1/4	1/4	1/4	19	11	49.5	25.5	14	Taper	Kogo
2050-3/8	3/8	3/8	19.5	11.5	53	28	16	Taper	Kogo
2050-1/2	1/2	1/2	23	14	63.5	33	21	Taper	Kogo

Female/male equal T

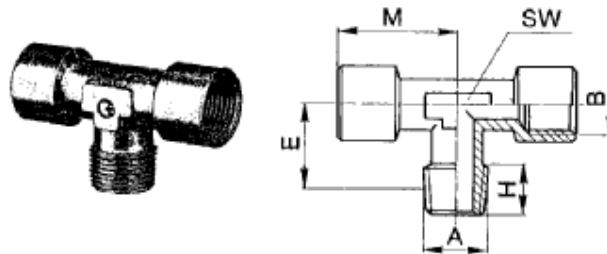

Part No	A	B	E	H	M	SW	Thread	Stock
2061-M5	M5	M5	9	4	9.5	9	Parallel	Kogo
2060-1/8	1/8	1/8	15	7.5	21	12	Taper	Yes
2060-1/4	1/4	1/4	19	11	25.5	14	Taper	Kogo
2060-3/8	3/8	3/8	19.5	11.5	28	16	Taper	Kogo
2060-1/2	1/2	1/2	23	14	33	21	Taper	Kogo

Female/male equal T

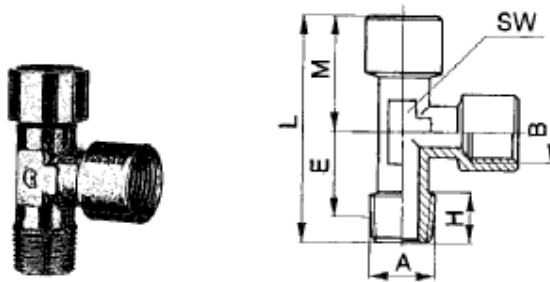

Part No	A	B	E	H	L	M	SW	Thread	Stock
2070-1/8	1/8	1/8	15	7.5	39.5	21	12	Taper	Kogo
2070-1/4	1/4	1/4	19	11	49.5	25.5	14	Taper	Kogo
2070-3/8	3/8	3/8	19.5	11.5	53	28	16	Taper	Kogo
2070-1/2	1/2	1/2	23	14	63	33	21	Taper	Kogo

Male equal elbow

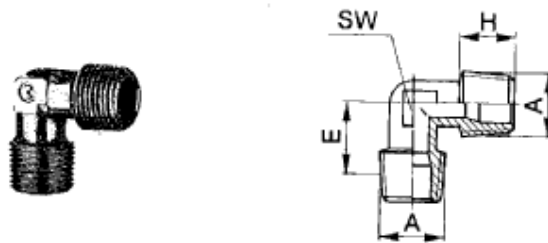

Part number	A	E	H	SW	Thread	Stock
2010-1/8	1/8	14	7.5	9	Taper	Kogo
2010-1/4	1/4	15.5	11	12	Taper	Kogo
2010-3/8	3/8	19.5	11.5	14	Taper	Kogo
2010-1/2	1/2	21.5	14	16	Taper	Kogo

Female equal elbow

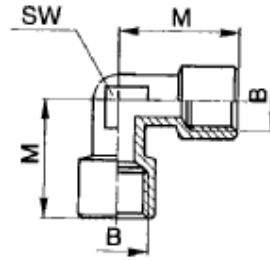

Part number	B	M	SW	Thread	Stock
2013-1/8	1/8	21	12	Parallel	Kogo
2013-1/4	1/4	25.5	14	Parallel	Kogo
2013-3/8	3/8	28	16	Parallel	Kogo
2013-1/2	1/2	33	21	Parallel	Kogo

Male/female equal elbow

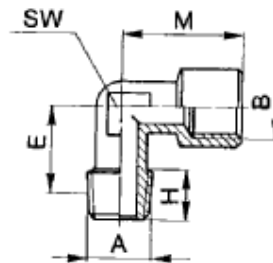

Part No	A	B	E	H	L	SW	Thread	Stock
2021-M5-M5	M5	M5	9	4	11	9	Parallel	Kogo
2020-1/8	1/8	1/8	15	7.5	21	12	Taper	Kogo
2020-1/4	1/4	1/4	19	11	25.5	14	Taper	Kogo
2020-3/8	3/8	3/8	19.5	11.5	28	16	Taper	Kogo
2020-1/2	1/2	1/2	23	14	33	21	Taper	Kogo

Female equal cross T

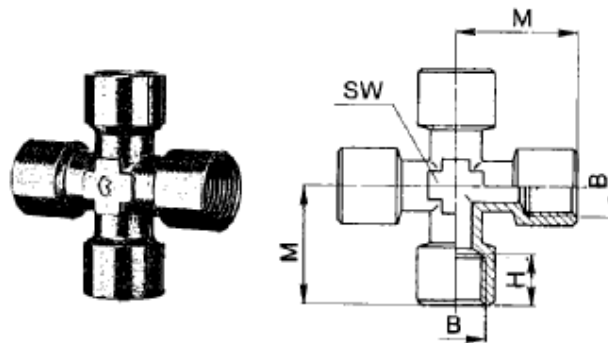

Part No	B	H	SW	Thread	Stock
2033-M5	M5	4	9	Parallel	Kogo
2033-1/8	1/8	7.5	21	Parallel	Kogo
2033-1/4	1/4	11	25.5	Parallel	Kogo
2033-3/8	3/8	11.5	28	Parallel	Kogo

Female/male Y union

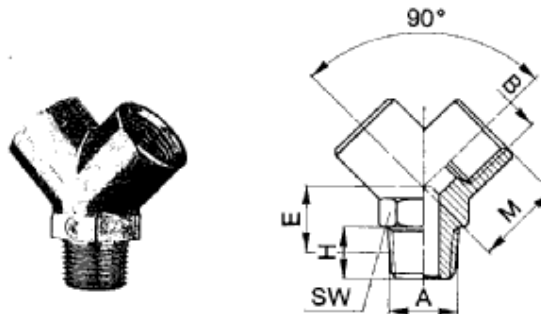

Part No	A	B	H	E	M	SW	Thread	Stock
2040-1/8-1/8	1/8	1/8	9.5	13	17.5	14	Taper	Kogo
2040-1/4-1/4	1/4	1/4	11	13	18.5	17	Taper	Kogo
2040-3/8-3/8	3/8	3/8	12	18	22.5	22	Taper	Kogo
2040-1/2-1/2	1/2	1/2	15.5	22.5	28	26	Taper	Kogo

Female Y union

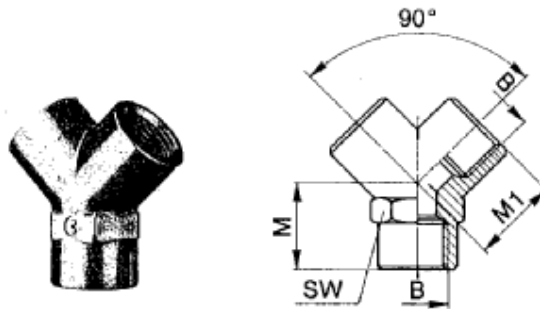

Part No	A	B	M1	SW	Thread	Stock
2043-1/8	1/8	17.5	17.5	14	Parallel	Kogo
2043-1/4	1/4	19	19	17	Parallel	Kogo
2043-3/8	3/8	22.5	22.5	22	Parallel	Kogo
2043-1/2	1/2	28	28	26	Parallel	Kogo

Stock

Kogo A standard stock item
 Yes In stock in the UK
 No Not on the AS400
 List Listed on the AS400, but nothing in stock

Port information details

M5 Standard M5 thread
 1/8 Standard BS parallel or tapered port thread to 1/8"
 1/4 Standard BS parallel or tapered port thread to 1/4"
 3/8 Standard BS parallel or tapered port thread to 3/8"
 1/2 Standard BS parallel or tapered port thread to 1/2"
 3/4 Standard BS parallel or tapered port thread to 3/4"

This sheet has been prepared by,
 Peter Lineham, March 2002

Sales Engineering Group
 SMC Pneumatics (UK) Ltd.
 Vincent Avenue
 Crownhill,
 Milton Keynes
 MK8 0AN