

600 W TVS in SMA

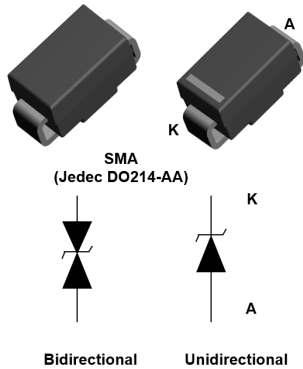

Features

- Peak pulse power:
 - 600 W (10/1000 μ s)
 - 4 kW (8/20 μ s)
- Stand-off voltage range from 5 V to 85 V
- Unidirectional and bidirectional types
- Low leakage current:
 - 0.2 μ A at 25 °C
 - 1 μ A at 85 °C
- Operating T_j max: 175 °C
- JEDEC registered package outline
- Resin meets UL94, V0

Product status link

[SMA6J5.0A](#), [SMA6J5.0CA](#),
[SMA6J6.0A](#), [SMA6J6.0CA](#),
[SMA6J6.5A](#), [SMA6J6.5CA](#),
[SMA6J8.5A](#), [SMA6J8.5CA](#),
[SMA6J10A](#), [SMA6J10CA](#),
[SMA6J12A](#), [SMA6J12CA](#),
[SMA6J13A](#), [SMA6J13CA](#),
[SMA6J15A](#), [SMA6J15CA](#),
[SMA6J18A](#), [SMA6J18CA](#),
[SMA6J20A](#), [SMA6J20CA](#),
[SMA6J24A](#), [SMA6J24CA](#),
[SMA6J26A](#), [SMA6J26CA](#),
[SMA6J28A](#), [SMA6J28CA](#),
[SMA6J33A](#), [SMA6J33CA](#),
[SMA6J40A](#), [SMA6J40CA](#),
[SMA6J48A](#), [SMA6J48CA](#),
[SMA6J58A](#), [SMA6J58CA](#),
[SMA6J70A](#), [SMA6J70CA](#),
[SMA6J85A](#), [SMA6J85CA](#).

Complies with the following standards

- UL94, V0
- J-STD-020 MSL level 1
- J-STD-002, JESD 22-B102 E3 and MIL-STD-750, method 2026 solderable matte tin plated leads
- JESD-201 class 2 whisker test
- IPC7531 footprint
- JEDEC registered package outline
- IEC 61000-4-4 level 4:
 - 4 kV
- IEC 61000-4-2, C = 150 pF - R = 330 Ω exceeds level 4:
 - 30 kV (air discharge)
 - 30 kV (contact discharge)

Description

The SMA6J series is designed to protect sensitive equipment against electrostatic discharges according to IEC 61000-4-2 and MIL STD 883, method 3015, and electrical overstress according to IEC 61000-4-4 and 5. This device is more generally used against surges below 600 W (10/1000 μ s).

The Planar technology makes it compatible with high-end circuits where low leakage current and high junction temperature are required to provide long term reliability and stability. SMA6J devices are packaged in SMA (SMA footprint in accordance with IPC 7531 standard).

1 Characteristics

Table 1. Absolute maximum ratings ($T_{amb} = 25\text{ }^{\circ}\text{C}$)

Symbol	Parameter	Value	Unit	
V_{PP}	Peak pulse voltage	IEC 61000-4-2 (C = 150 pF, R = 330 Ω)		
		Contact discharge	30	kV
		Air discharge	30	
P_{PP}	Peak pulse power dissipation	T_j initial = T_{amb}	600	W
T_{stg}	Storage temperature range		-65 to +175	$^{\circ}\text{C}$
T_j	Operating junction temperature range		-55 to +175	$^{\circ}\text{C}$
T_L	Maximum lead temperature for soldering during 10 s		260	$^{\circ}\text{C}$

Figure 1. Electrical characteristics - parameter definitions

Figure 2. Pulse definition for electrical characteristics

Table 2. Electrical characteristics - parameter values ($T_{amb} = 25\text{ °C}$, unless otherwise specified)

Type	I_{RM} max at V_{RM}			V_{BR} at $I_{BR}^{(1)}$				10 / 1000 μ s			8 / 20 μ s			αT
								$V_{CL}^{(2)(3)}$	$I_{PP}^{(4)}$	R_D	$V_{CL}^{(2)(3)}$	$I_{PP}^{(4)}$	R_D	
	25 °C	85 °C		Min.	Typ.	Max.		Max.		Max.	Max.		Max.	Max.
	μ A	V		V			mA	V	A	Ω	V	A	Ω	$10^{-4}/\text{°C}$
SMA6J5.0A/CA	20	50	5.0	6.40	6.74	7.07	10	9.1	68	0.029	14.4	275	0.027	5.7
SMA6J6.0A/CA	20	50	6.0	6.70	7.05	7.41	10	9.5	61	0.034	14.8	270	0.027	5.9
SMA6J6.5A/CA	20	50	6.5	7.20	7.58	7.96	10	10.2	56	0.040	15.2	266	0.027	6.1
SMA6J8.5A/CA	20	50	8.5	9.4	9.9	10.4	1	13.3	41.7	0.070	19.5	205	0.044	7.3
SMA6J10A/CA	0.2	1	10	11.1	11.7	12.3	1	15.7	37	0.093	21.7	184	0.051	7.8
SMA6J12A/CA	0.2	1	12	13.3	14.0	14.7	1	18.8	31	0.133	25.3	157	0.068	8.3
SMA6J13A/CA	0.2	1	13	14.4	15.2	15.9	1	20.4	29	0.154	27.2	147	0.076	8.4
SMA6J15A/CA	0.2	1	15	16.7	17.6	18.5	1	23.6	25.1	0.206	32.5	123	0.114	8.8
SMA6J18A/CA	0.2	1	18	20.0	21.1	22.1	1	28.3	21.5	0.288	39.3	102	0.168	9.2
SMA6J20A/CA	0.2	1	20	22.2	23.4	24.5	1	31.4	19.4	0.354	42.8	93	0.196	9.4
SMA6J24A/CA	0.2	1	24	26.7	28.1	29.5	1	37.8	16	0.516	50	80	0.256	9.6
SMA6J26A/CA	0.2	1	26	28.9	30.4	31.9	1	40.9	14.9	0.600	53.5	75	0.288	9.7
SMA6J28A/CA	0.2	1	28	31.1	32.7	34.4	1	44.0	13.8	0.697	59	68	0.363	9.8
SMA6J33A/CA	0.2	1	33	36.7	38.6	40.6	1	51.9	11.8	0.963	69	57	0.512	10.0
SMA6J40A/CA	0.2	1	40	44.4	46.7	49.1	1	62.8	9.7	1.42	84	48	0.728	10.1
SMA6J48A/CA	0.2	1	48	53.3	56.1	58.9	1	75.4	8.1	2.04	100	40	1.03	10.3
SMA6J58A/CA	0.2	1	58	64.4	67.8	71.2	1	91.1	6.7	2.97	121	33	1.51	10.4
SMA6J70A/CA	0.2	1	70	77.8	81.9	86.0	1	110	5.5	4.38	146	27	2.22	10.5
SMA6J85A/CA	0.2	1	85	94	99	104	1	134	4.6	6.45	178	22.5	3.29	10.6

1. To calculate V_{BR} versus T_j : V_{BR} at $T_j = V_{BR}$ at $25\text{ °C} \times (1 + \alpha T \times (T_j - 25))$

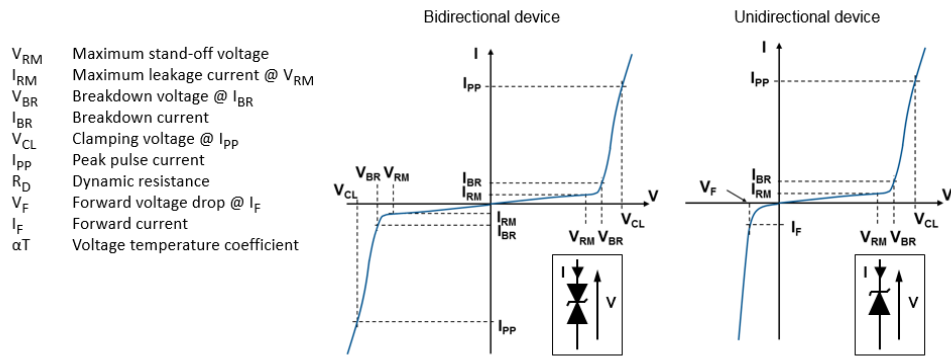
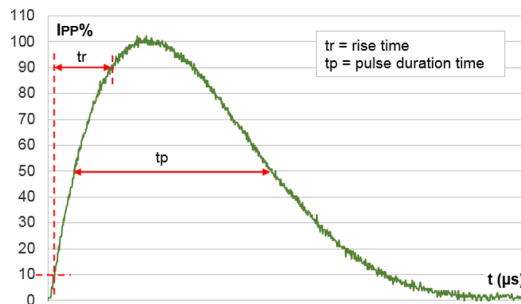
2. To calculate V_{CL} versus T_j : V_{CL} at $T_j = V_{CL}$ at $25\text{ °C} \times (1 + \alpha T \times (T_j - 25))$

3. To calculate V_{CL} max versus $I_{PPappli}$: $V_{CLmax} = V_{BR} \text{ max} + R_D \times I_{PPappli}$

4. Surge capability given for both directions for unidirectional and bidirectional devices

1.1 Characteristics (curves)

Figure 3. Maximum peak power dissipation versus initial junction temperature

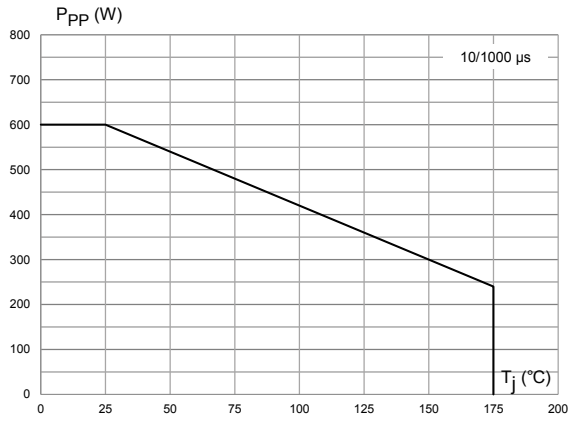

Figure 4. Maximum peak pulse power versus exponential pulse duration

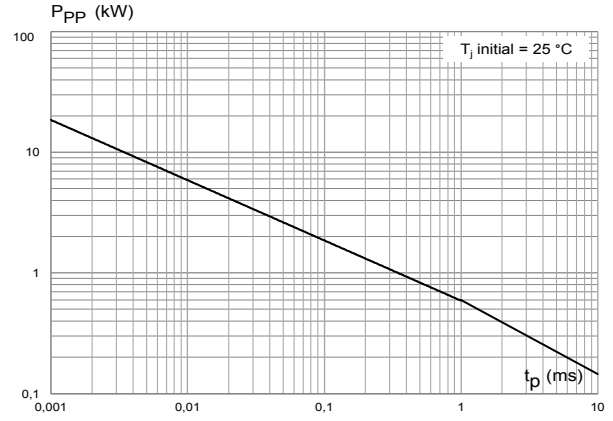

Figure 5. Maximum peak pulse current versus clamping voltage

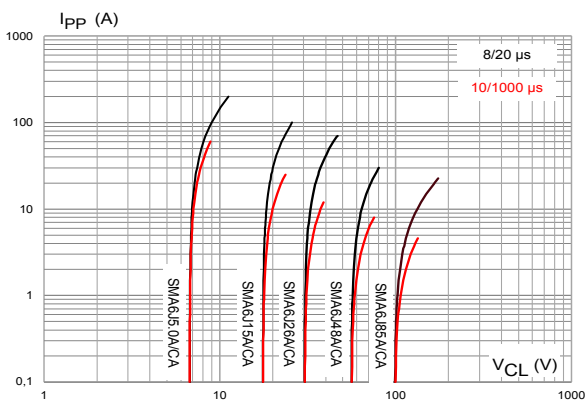

Figure 6. Dynamic resistance versus pulse duration

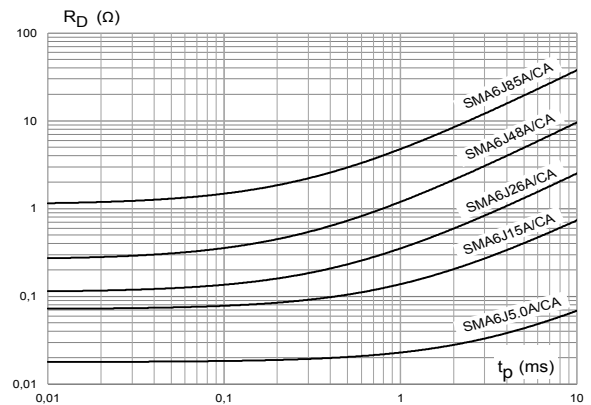

Figure 7. Junction capacitance versus reverse applied voltage (unidirectional type)

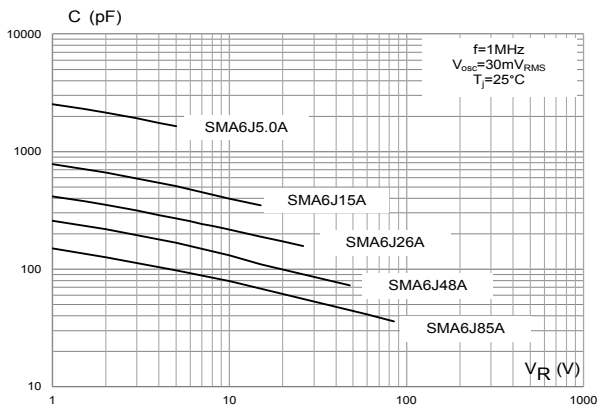

Figure 8. Junction capacitance versus applied voltage (bidirectional type)

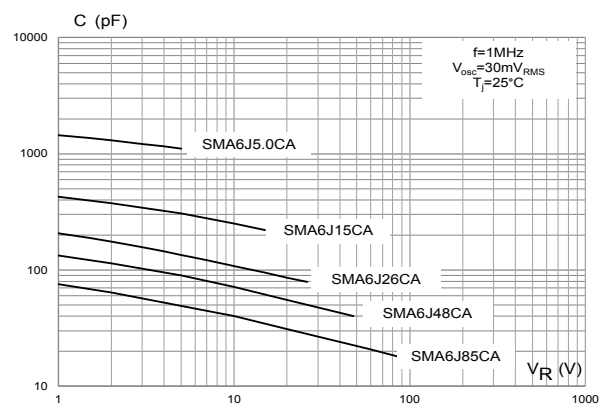

Figure 9. Leakage current versus junction temperature

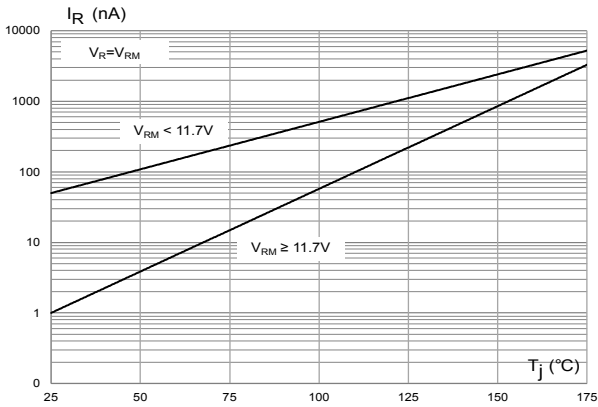

Figure 10. Peak forward voltage drop versus peak forward current

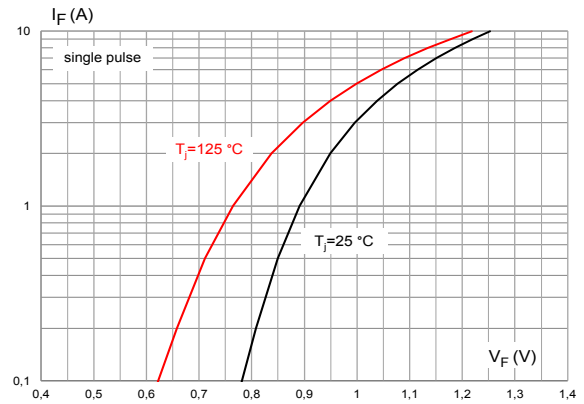

Figure 11. Thermal impedance junction to ambient versus pulse duration

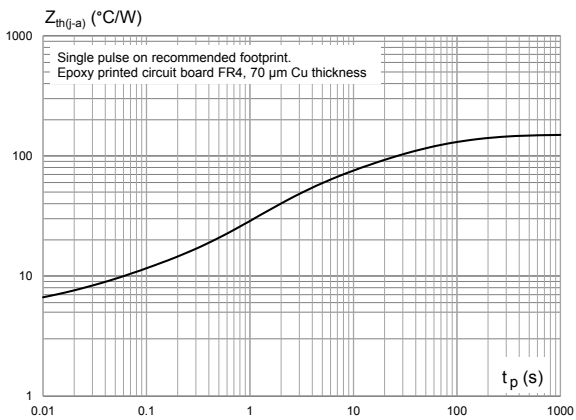
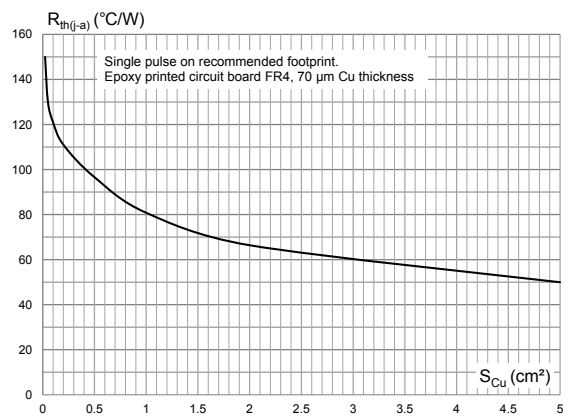

Figure 12. Thermal resistance junction to ambient versus copper area under each lead



2 Package information

In order to meet environmental requirements, ST offers these devices in different grades of **ECOPACK** packages, depending on their level of environmental compliance. ECOPACK specifications, grade definitions and product status are available at: www.st.com. ECOPACK is an ST trademark.

2.1 SMA package information

Figure 13. SMA package outline

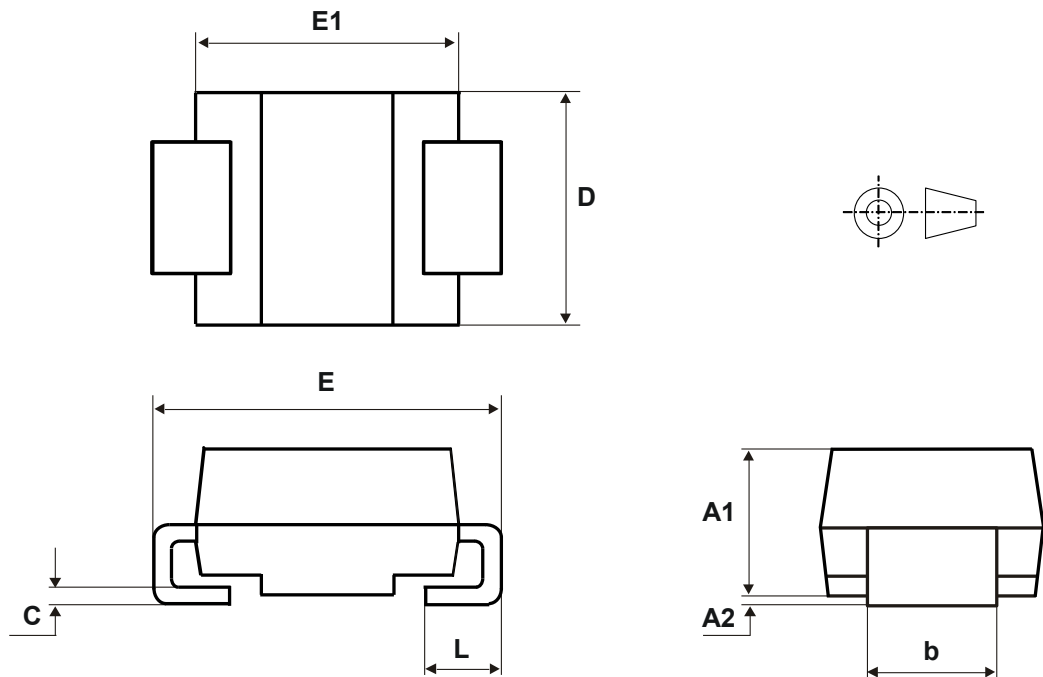

Table 3. SMA package mechanical data

Ref.	Dimensions			
	Millimeters		Inches	
	Min.	Max.	Min.	Max.
A1	1.90	2.45	0.074	0.097
A2	0.05	0.20	0.001	0.008
b	1.25	1.65	0.049	0.065
c	0.15	0.40	0.005	0.016
D	2.25	2.90	0.088	0.115
E	4.80	5.35	0.188	0.211
E1	3.95	4.60	0.155	0.182
L	0.75	1.50	0.029	0.060

Figure 14. SMA recommended footprint in mm (inches)

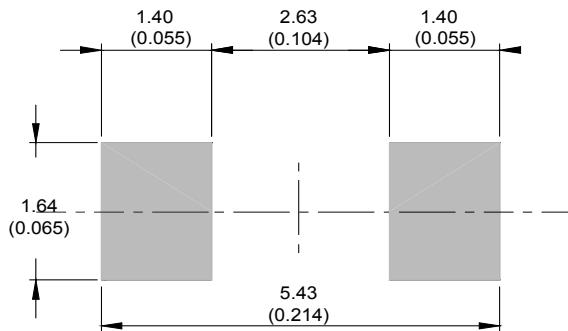

Figure 15. SMA marking

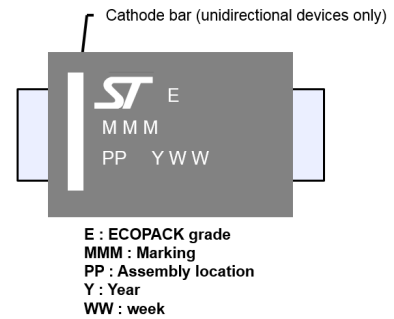
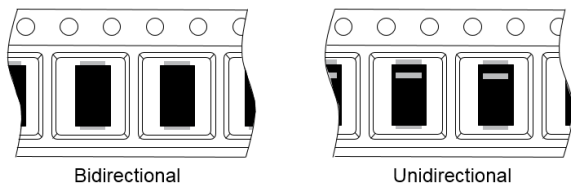

Figure 16. Package orientation in reel



Taped according to EIA-481
Pocket dimensions are not on scale.
Pocket shape may vary depending on package
On bidirectional devices, marking and logo may not be always in the same direction.

Figure 17. Tape and reel orientation

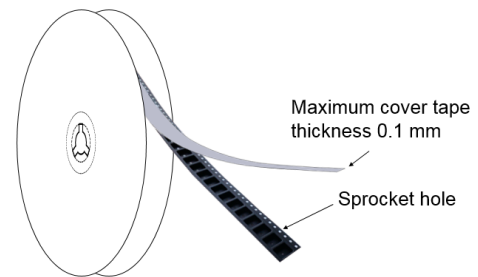

Figure 18. 13" reel dimension values

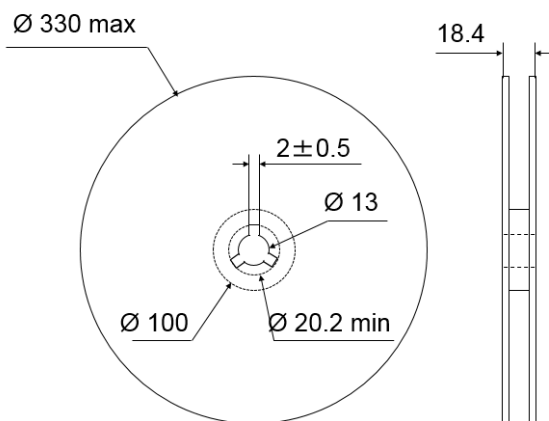

Figure 19. Inner box dimension values

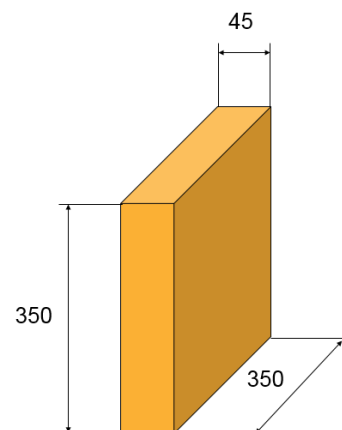
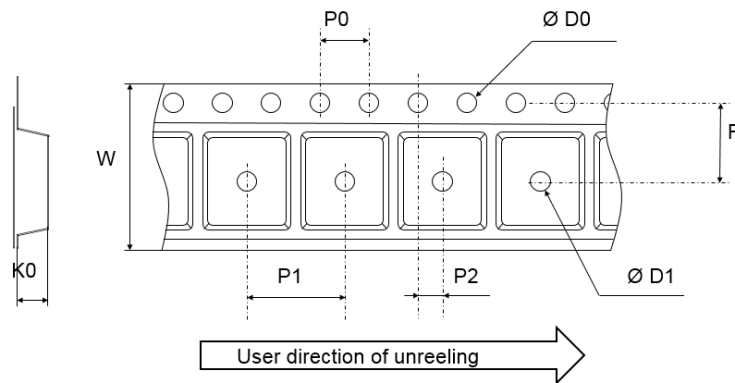

Figure 20. Tape outline



Note: Pocket dimensions are not on scale
Pocket shape may vary depending on package

Table 4. Tape dimension values

Ref.	Dimensions		
	Millimeters		
	Min.	Typ.	Max.
D0	1.40	1.50	1.60
D1	1.50		
F	5.40	5.50	5.60
K0	2.26	2.36	2.46
P0	3.90	4.00	4.10
P1	3.90	4.00	4.10
P2	1.95	2.00	2.05
W	11.70	12.00	12.30

2.2 Reflow profile

Figure 21. ST ECOPACK recommended soldering reflow profile for PCB mounting

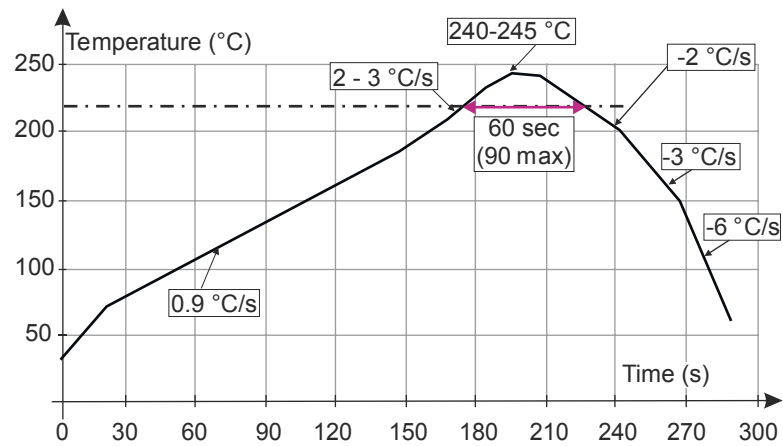

Note: Minimize air convection currents in the reflow oven to avoid component movement. Maximum soldering profile corresponds to the latest IPC/JEDEC J-STD-020.

3 Ordering information

Table 5. Ordering information

Order code	Marking	Package	Weight	Base qty.	Delivery mode
SMA6JxxA/CA ⁽¹⁾	See Table 6. Marking.	SMA	72 mg	5000	Tape and reel

1. Where xx is V_{RM} and A or CA indicates unidirectional or bidirectional version.

Table 6. Marking

Type	Marking	Type	Marking
SMA6J5.0A-TR	6UA	SMA6J5.0CA-TR	6BA
SMA6J6.0A-TR	6UB	SMA6J6.0CA-TR	6BB
SMA6J6.5A-TR	6UC	SMA6J6.5CA-TR	6BC
SMA6J8.5A-TR	6UD	SMA6J8.5CA-TR	6BD
SMA6J10A-TR	6UE	SMA6J10CA-TR	6BE
SMA6J12A-TR	6UF	SMA6J12CA-TR	6BF
SMA6J13A-TR	6UG	SMA6J13CA-TR	6BG
SMA6J15A-TR	6UH	SMA6J15CA-TR	6BH
SMA6J18A-TR	6UJ	SMA6J18CA-TR	6BJ
SMA6J20A-TR	6UK	SMA6J20CA-TR	6BK
SMA6J24A-TR	6UM	SMA6J24CA-TR	6BM
SMA6J26A-TR	6UN	SMA6J26CA-TR	6BN
SMA6J28A-TR	6UO	SMA6J28CA-TR	6BO
SMA6J33A-TR	6UQ	SMA6J33CA-TR	6BQ
SMA6J40A-TR	6UR	SMA6J40CA-TR	6BR
SMA6J48A-TR	6US	SMA6J48CA-TR	6BS
SMA6J58A-TR	6UT	SMA6J58CA-TR	6BT
SMA6J70A-TR	6UU	SMA6J70CA-TR	6BU
SMA6J85A-TR	6UV	SMA6J85CA-TR	6BV

Revision history

Table 7. Document revision history

Date	Revision	Changes
21-Feb-2007	1	First issue.
7-Nov-2007	2	Updated Description. Improved readability of Ordering information scheme. Reformatted to current standards.
04-Aug-2014	3	Updated weight in Table 7.
28-Oct-2015	4	Updated Table 4 and Figure 3.
04-Jul-2017	5	Updated Table 4.
22-Jan-2018	6	Updated Table3.
30-Aug-2018	7	Updated Table 6. Marking.
30-Mar-2022	8	Update after termination of $V_{RM} > 90$ V. Minor text changes.
04-May-2022	9	Updated Description.
31-May-2022	10	Minor text changes.

IMPORTANT NOTICE – READ CAREFULLY

STMicroelectronics NV and its subsidiaries (“ST”) reserve the right to make changes, corrections, enhancements, modifications, and improvements to ST products and/or to this document at any time without notice. Purchasers should obtain the latest relevant information on ST products before placing orders. ST products are sold pursuant to ST’s terms and conditions of sale in place at the time of order acknowledgment.

Purchasers are solely responsible for the choice, selection, and use of ST products and ST assumes no liability for application assistance or the design of purchasers’ products.

No license, express or implied, to any intellectual property right is granted by ST herein.

Resale of ST products with provisions different from the information set forth herein shall void any warranty granted by ST for such product.

ST and the ST logo are trademarks of ST. For additional information about ST trademarks, refer to www.st.com/trademarks. All other product or service names are the property of their respective owners.

Information in this document supersedes and replaces information previously supplied in any prior versions of this document.

© 2022 STMicroelectronics – All rights reserved

Mouser Electronics

Authorized Distributor

Click to View Pricing, Inventory, Delivery & Lifecycle Information:

[STMicroelectronics:](#)

[SMA6J10A-TR](#) [SMA6J10CA-TR](#) [SMA6J12A-TR](#) [SMA6J12CA-TR](#) [SMA6J13A-TR](#) [SMA6J13CA-TR](#) [SMA6J15A-TR](#)
[SMA6J15CA-TR](#) [SMA6J18A-TR](#) [SMA6J18CA-TR](#) [SMA6J20A-TR](#) [SMA6J20CA-TR](#) [SMA6J24A-TR](#) [SMA6J24CA-](#)
[TR](#) [SMA6J26A-TR](#) [SMA6J26CA-TR](#) [SMA6J28A-TR](#) [SMA6J33A-TR](#) [SMA6J33CA-TR](#) [SMA6J40A-TR](#) [SMA6J40CA-](#)
[TR](#) [SMA6J48A-TR](#) [SMA6J48CA-TR](#) [SMA6J5.0A-TR](#) [SMA6J5.0CA-TR](#) [SMA6J58A-TR](#) [SMA6J58CA-TR](#)
[SMA6J6.0A-TR](#) [SMA6J6.0CA-TR](#) [SMA6J6.5A-TR](#) [SMA6J6.5CA-TR](#) [SMA6J70A-TR](#) [SMA6J70CA-TR](#) [SMA6J8.5A-](#)
[TR](#) [SMA6J8.5CA-TR](#) [SMA6J100A-TR](#) [SMA6J100CA-TR](#) [SMA6J130A-TR](#) [SMA6J130CA-TR](#) [SMA6J154A-TR](#)
[SMA6J154CA-TR](#) [SMA6J170A-TR](#) [SMA6J170CA-TR](#) [SMA6J188A-TR](#) [SMA6J188CA-TR](#) [SMA6J85A-TR](#)
[SMA6J85CA-TR](#) [SMA6J28CA-TR](#)