

■ **Features**

- Constant Voltage PWM style output with frequency 1KHz
- Plastic housing with class II design
- Built-in active PFC function
- No load power consumption<0.5W(Blank-Type)
- Function options: 2 in 1 dimming (dim-to-off); Auxiliary DC output
- 3 years warranty

■ **Applications**

- LED strip lighting
- Indoor LED lighting
- LED decorative lighting
- LED architecture lighting

■ **Description**

IDLV-45 series is a 45W AC/DC LED driver featuring the constant voltage mode PWM style output design. IDLV-45 operates from 90~295VAC and offers models with different rated voltage ranging between 12V and 60V. Thanks to the high efficiency up to 90%, with the fanless design, the entire series is able to operate for -20°C~+85°C case temperature under free air convection. IDLV-45 is equipped with various function options, such as dimming methodologies, so as to provide the design flexibility for LED lighting system.

■ **Model Encoding**

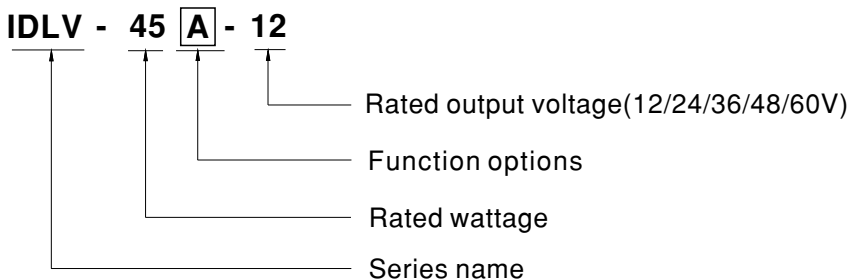

| Type | Function | Note |
|-------|--|----------|
| Blank | 2 in 1 dimming (0~10VDC and 10V PWM) | In Stock |
| A | 2 in 1 dimming and Auxiliary DC output | In Stock |



SPECIFICATION

| MODEL | | IDLV-45□-12 | IDLV-45□-24 | IDLV-45□-36 | IDLV-45□-48 | IDLV-45□-60 |
|--------------|---|---|-------------|-------------|-------------|-------------|
| OUTPUT | DC VOLTAGE | 12V | 24V | 36V | 48V | 60V |
| | RATED CURRENT | 3.0A | 1.88A | 1.25A | 0.94A | 0.75A |
| | RATED POWER | 36W | 45.12W | 45W | 45.12W | 45W |
| | DIMMING RANGE | 0~100% | | | | |
| | VOLTAGE TOLERANCE | ±10% | | | | |
| | PWM FREQUENCY (Typ.) | 1KHz(±20%) | | | | |
| | SETUP TIME Note.3 | 500ms / 230VAC 1200ms/115VAC | | | | |
| | AUXILIARY DC OUTPUT Note.4 | Nominal 12V(deviation 11.4~12.6)@50mA for A-Type only | | | | |
| INPUT | VOLTAGE RANGE Note.2 | 90 ~ 295VAC 127 ~ 417VDC (Please refer to "STATIC CHARACTERISTIC" section) | | | | |
| | FREQUENCY RANGE | 47 ~ 63Hz | | | | |
| | POWER FACTOR (Typ.) | PF>0.95/115VAC, PF>0.92/230VAC, PF>0.9/277VAC@full load (Please refer to "POWER FACTOR (PF) CHARACTERISTIC" section) | | | | |
| | TOTAL HARMONIC DISTORTION | THD< 20%(@load≥60%/115VAC,230VAC; @load≥75%/277VAC) (Please refer to "TOTAL HARMONIC DISTORTION" section) | | | | |
| | EFFICIENCY (Typ.) | 84% | 86% | 88% | 88% | 90% |
| | AC CURRENT (Typ.) | 0.6A / 115VAC 0.4A / 230VAC 0.3A / 277VAC | | | | |
| | INRUSH CURRENT(Typ.) | COLD START 30A(twidth=150μs measured at 50% Ipeak) at 230VAC; Per NEMA 410 | | | | |
| | MAX. No. of PSUs on 16A CIRCUIT BREAKER | 32 units (circuit breaker of type B) / 32 units (circuit breaker of type C) at 230VAC | | | | |
| | LEAKAGE CURRENT | <0.75mA / 277VAC | | | | |
| | NO LOAD POWER CONSUMPTION | <0.5W for Blank-Type, <1.2W for A-Type | | | | |
| PROTECTION | SHORT CIRCUIT | Shut down O/P voltage, re-power on to recovery | | | | |
| | OVER CURRENT | 105 ~ 115% Protection type : Hiccup mode, recovers automatically after fault condition is removed | | | | |
| ENVIRONMENT | WORKING TEMP. | Tcase=-20 ~ +85°C (Please refer to " OUTPUT LOAD vs TEMPERATURE" section) | | | | |
| | MAX. CASE TEMP. | Tcase=+85°C | | | | |
| | WORKING HUMIDITY | 20 ~ 90% RH non-condensing | | | | |
| | STORAGE TEMP., HUMIDITY | -40 ~ +80°C, 10 ~ 95% RH | | | | |
| | TEMP. COEFFICIENT | ±0.03%/°C (0 ~ 40°C) | | | | |
| | VIBRATION | 10 ~ 500Hz, 2G 10min./1cycle, period for 60min. each along X, Y, Z axes | | | | |
| SAFETY & EMC | SAFETY STANDARDS | UL8750,CSA C22.2 NO.250.13-12; EN/AS/NZS 61347-1 & EN/AS/NZS 61347-2-13 independent, EN62384, GB19510.1, GB19510.14, BIS IS15885(for IDLV-45-12,24,48 only), EAC TP TC 004 approved | | | | |
| | WITHSTAND VOLTAGE | I/P-O/P:3.75KVAC | | | | |
| | ISOLATION RESISTANCE | I/P-O/P:100M Ohms / 500VDC / 25°C/ 70% RH | | | | |
| | EMC EMISSION | Compliance to EN55015, EN61000-3-2 Class C (@load ≥ 60%) ; EN61000-3-3,GB17743,GB17625.1, EAC TP TC 020 | | | | |
| | EMC IMMUNITY | Compliance to EN61000-4-2,3,4,5,6,8,11; EN61547, light industry level(surge immunity:Line-Line:1KV), EAC TP TC 020 | | | | |
| OTHERS | MTBF | 386.59Khrs min. MIL-HDBK-217F (25°C) | | | | |
| | DIMENSION | 120*75*25mm (L*W*H) | | | | |
| | PACKING | 0.22Kg;54pcs/13Kg/ 0.93CUFT | | | | |
| NOTE | 1. All parameters NOT specially mentioned are measured at 230VAC input, rated current and 25°C of ambient temperature. 2. De-rating may be needed under low input voltages. Please refer to "STATIC CHARACTERISTIC" sections for details. 3. Length of set up time is measured at cold first start. Turning ON/OFF the driver may lead to increase of the set up time. 4. Aux. 12V will be damaged with short circuit; It will not be available with dimming off or output no load condition. 5. The driver is considered as a component that will be operated in combination with final equipment. Since EMC performance will be affected by the complete installation, the final equipment manufacturers must re-qualify EMC Directive on the complete installation again. 6. The ambient temperature derating of 3.5°C/1000m with fanless models and of 5°C/1000m with fan models for operating altitude higher than 2000m(6500ft). | | | | | |

■ DIMMING OPERATION

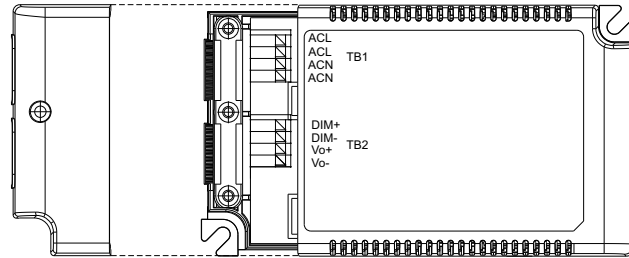

※ **Dimming principle for PWM style output**

Dimming is achieved by varying the duty cycle of the output current.

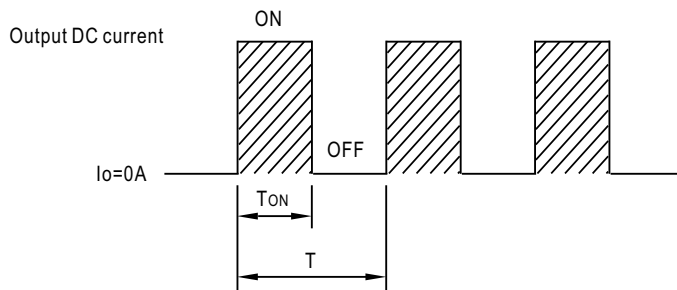

$$\text{Duty cycle(\%)} = \frac{T_{ON}}{T} \times 100\%$$

Output PWM frequency : 1KHz(±20%)

※ **2 in 1 dimming function**

◎ Applying additive 0 ~ 10VDC

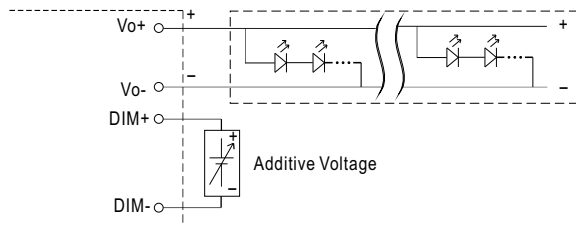

“DO NOT connect "DIM- to Vo-”

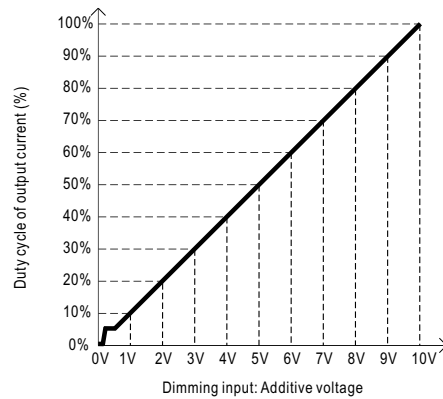

◎ Applying additive 10V PWM signal (frequency range 300~3000Hz):

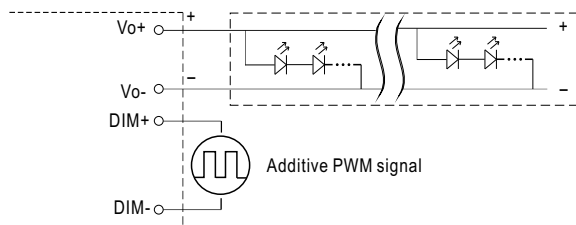

“DO NOT connect "DIM- to Vo-”

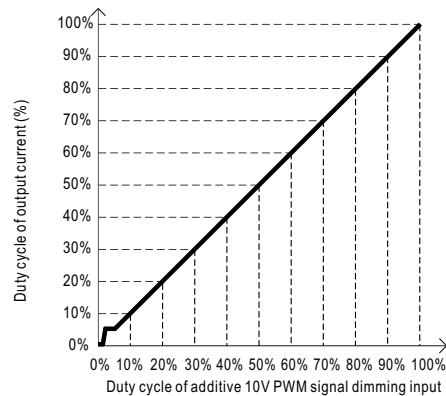

Note : 1. Min. duty cycle of output current is about 8% and the output current is not defined when 0% < Iout < 8%.
 2. The duty cycle of output current could drop down to 0% when dimming input is about 0Vdc or 10V PWM signal with 0% duty cycle.

OUTPUT LOAD vs TEMPERATURE

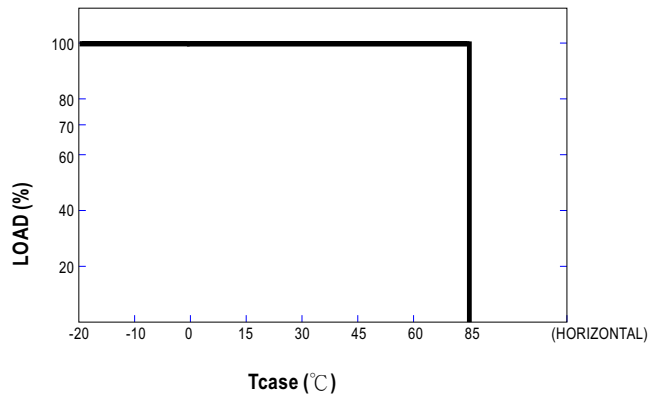
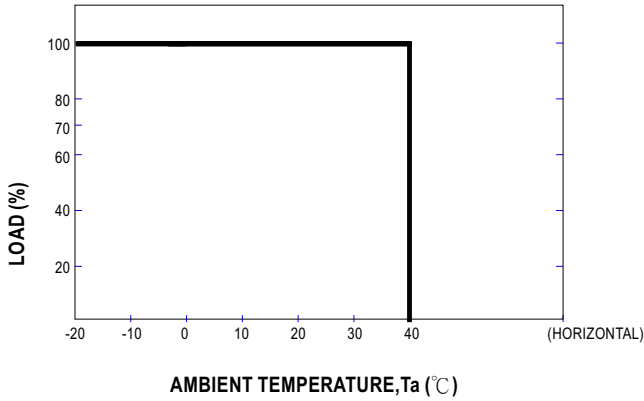

STATIC CHARACTERISTIC

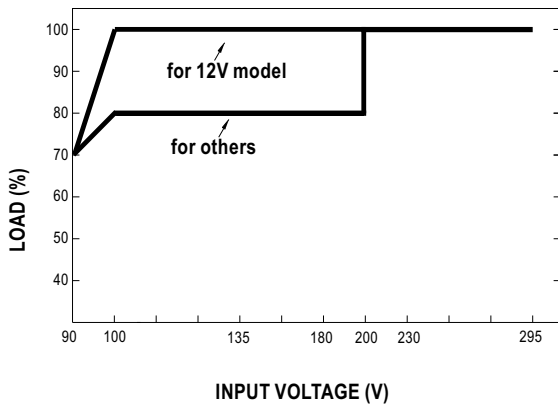

※ De-rating is needed under low input voltage.

POWER FACTOR (PF) CHARACTERISTIC

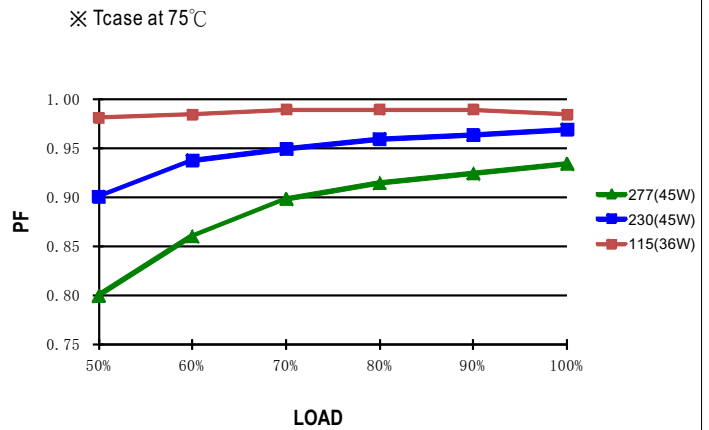

TOTAL HARMONIC DISTORTION (THD)

※ 60V Model, Tcase at 75°C

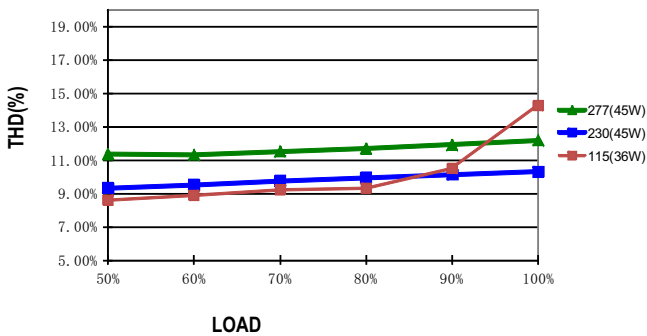

EFFICIENCY vs LOAD

IDLV-45 series possess superior working efficiency that up to 90% can be reached in field applications.

※ 60V Model, Tcase at 75°C

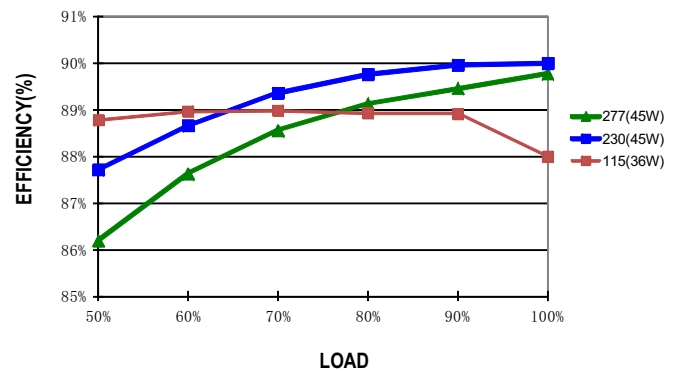

■ BLOCK DIAGRAM

fosc : 70~150KHz

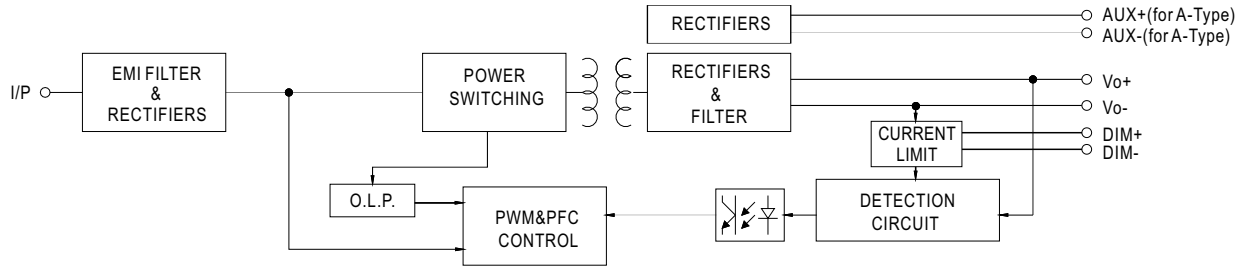

■ MECHANICAL SPECIFICATION

※ Blank-Type

Case No. IDLC-45A Unit:mm

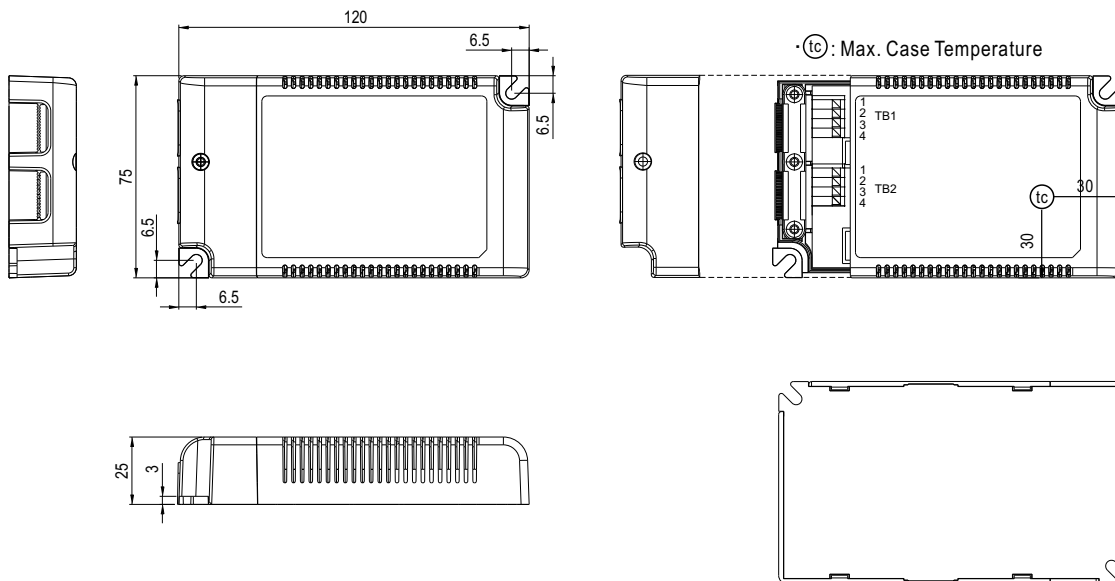

NOTE: Please use wires with a cross section of 0.75~1.5mm² for TB1 and wires with a cross section of 0.5~1.5mm² for TB2.

Terminal Pin No. Assignment(TB1)

| Pin No. | Assignment |
|---------|------------|
| 1 | ACL |
| 2 | ACL |
| 3 | ACN |
| 4 | ACN |

Terminal Pin No. Assignment(TB2)

| Pin No. | Assignment |
|---------|------------|
| 1 | DIM+ |
| 2 | DIM- |
| 3 | Vo+ |
| 4 | Vo- |

※ A-Type

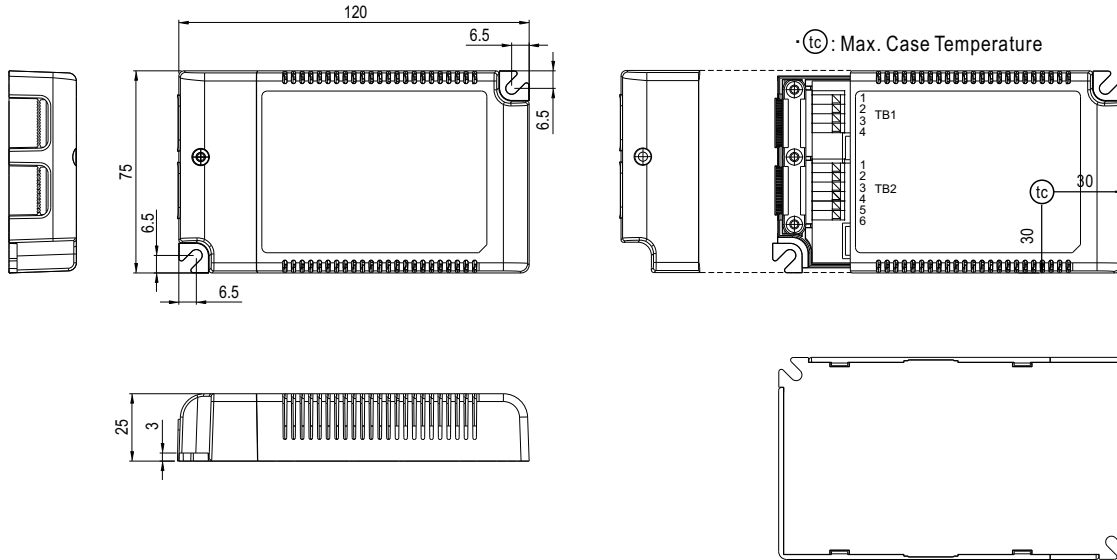

NOTE: Please use wires with a cross section of 0.75~1.5mm² for TB1 and wires with a cross section of 0.5~1.5mm² for TB2.

Terminal Pin No. Assignment(TB1)

| Pin No. | Assignment |
|---------|------------|
| 1 | ACL |
| 2 | ACL |
| 3 | ACN |
| 4 | ACN |

Terminal Pin No. Assignment(TB2)

| Pin No. | Assignment | Pin No. | Assignment |
|---------|------------|---------|------------|
| 1 | DIM+ | 4 | Vo- |
| 2 | DIM- | 5 | AUX+ |
| 3 | Vo+ | 6 | AUX- |

■ INSTALLATION MANUAL

Please refer to : <http://www.meanwell.com/manual.html>