



LFH-SBX40G1AS10SZ0

LFH

PRESSURE SENSORS

SICK
Sensor Intelligence.



Illustration may differ



Ordering information

Type	Part no.
LFH-SBX40G1AS10SZ0	6040943

Other models and accessories → www.sick.com/LFH

Detailed technical data

Features

Medium	Fluids
Pressure type	Gauge pressure
Pressure unit	bar
Measuring range	0 bar ... 0.4 bar
Process temperature	-10 °C ... +50 °C
Output signal	4 mA ... 20 mA, 2-wire
Length of cable	10 m
Cable material	PUR (tensile strength 1000 N), FEP optional available (tensile strength 500 N)

Mechanics/electronics

Wetted parts	Housing: Stainless steel Pressure connection/diaphragm: CrNi steel Protection cap: PA
Connection type	PUR cable
Supply voltage	10 V DC ... 30 V DC 14 V DC ... 30 V DC with output signal 0 V ... 10 V (only with enhanced variant)
Electrical safety	Protection class: III Short-circuit protection: Q _A towards M Reverse polarity protection: L ⁺ to M Surge protection: According to EN 61000-4-5 (1.5 J) optional for enhanced variant
Dielectric strength	500 V DC, NEC Class 02 power supply (low voltage and low current max. 100 VA even in the event of a fault)
CE-conformity	EMC directive: 2014/30/EU, EN 61 326-2-3
Weight sensor	0.18 kg
Cable weight	0.08 kg/m
Enclosure rating	IP68
Protection class III	✓

Performance

Non-linearity	≤ ± 0.2 %, of span (Best Fit Straight Line, BFSL) according to IEC 61298-2
Accuracy	≤ ± 0.5 % of the span
Non-repeatability	≤ ± 0.1 % of the span

Long-term drift/one-year stability	≤ ± 0.2 % of span (at reference conditions)
Temperature coefficient in rated temperature range	Mean TC of zero: ≤ 0.2 % of span / 10 K (< 0.4 % for pressure ranges ≤ 0.25 bar), Mean TC of span ≤ 0.2 % of span / 10 K
Rated temperature range	0 °C ... +50 °C

Ambient data

Storage temperature	-30 °C ... +80 °C
----------------------------	-------------------

Classifications

ECl@ss 5.0	27200614
ECl@ss 5.1.4	27200614
ECl@ss 6.0	27200614
ECl@ss 6.2	27200614
ECl@ss 7.0	27200614
ECl@ss 8.0	27200614
ECl@ss 8.1	27200614
ECl@ss 9.0	27200614
ECl@ss 10.0	27200614
ECl@ss 11.0	27200614
ETIM 5.0	EC011478
ETIM 6.0	EC011478
ETIM 7.0	EC011478
UNSPSC 16.0901	41111950



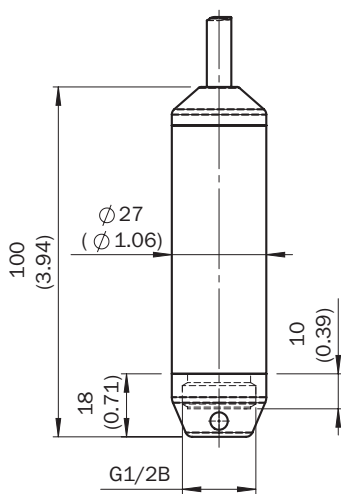

Dimensional drawing (Dimensions in mm (inch))

Standard version (Immersion depth up to 100 m)



Recommended accessories

Other models and accessories → www.sick.com/LFH

	Brief description	Type	Part no.
Other mounting accessories			
	Additional weight for stabilizing the LFH level sensor in moving liquids. Interior process connection G 1/2, is fastened to the level sensor instead of the protective cap. Weight: 500 g., Stainless steel 1.4571	BEF-AW-LFHSST-0001	5324308
Terminal and alignment brackets			
	Cable tension clamp for mounting the connection cable of the level sensor, max. tensile load = 2.5 kN (not to be used with FEP cable), steel, zinc coated, plastic	BEF-CC-LFH001-0001	5324307
Adapters and distributors			
	Dimensions (W x D x H) 57 mm x 130 mm x 94 mm, for electrical connection of level probe LFH	ASK-CB-LFH-PCO-0001	5324310
Protection filter			
	Protection filter for connection cable. Prevents humidity from entering the ventilation tube of the connection cable. For self-mounting at cable end.	APR-VF-LFH001-0001	5324309

SICK AT A GLANCE

SICK is one of the leading manufacturers of intelligent sensors and sensor solutions for industrial applications. A unique range of products and services creates the perfect basis for controlling processes securely and efficiently, protecting individuals from accidents and preventing damage to the environment.

We have extensive experience in a wide range of industries and understand their processes and requirements. With intelligent sensors, we can deliver exactly what our customers need. In application centers in Europe, Asia and North America, system solutions are tested and optimized in accordance with customer specifications. All this makes us a reliable supplier and development partner.

Comprehensive services complete our offering: SICK LifeTime Services provide support throughout the machine life cycle and ensure safety and productivity.

For us, that is “Sensor Intelligence.”

WORLDWIDE PRESENCE:

Contacts and other locations –www.sick.com