

ASBS... / LED 5-4

3 + PE

Steckbare Aktor-Sensor-Box,
4 - 8-fach, 4 polig, LED-
Betriebsanzeige grün und
Funktionsanzeige gelb,
Schutzleiteranschluss

Quick connect interface box
actuator/sensor, 4 - 8 ways,
4 poles, with built-in LED-oper-
ation green and function indi-
cators yellow, earth connection

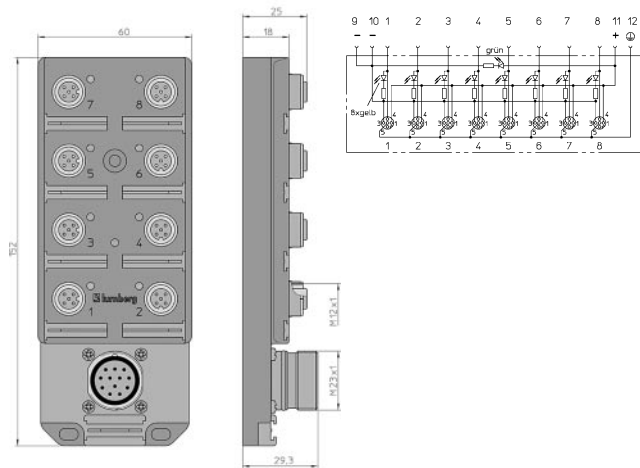
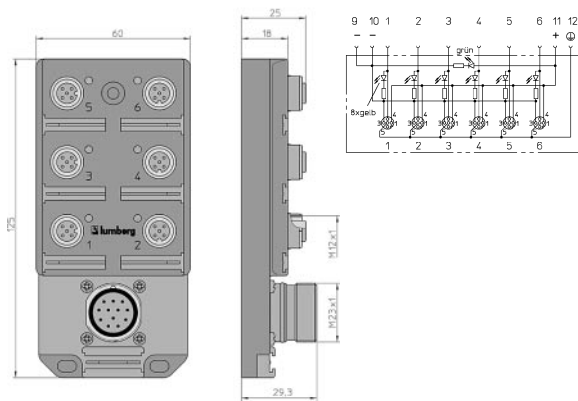
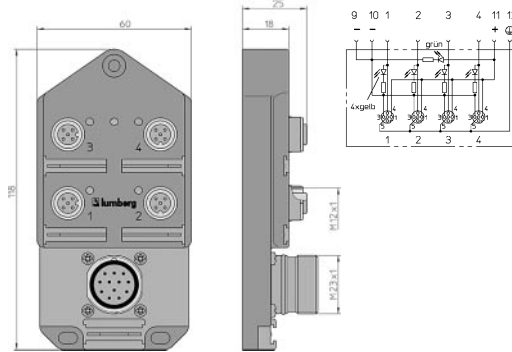

Kontaktbelegung Wiring diagram

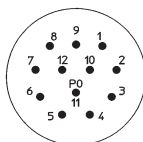

4-fach / 4 ways

- | | |
|-------------------|------|
| 1 = 11 | (+) |
| 3 = 9 gebrückt 10 | (-) |
| 4 = 1 | (1) |
| 2 | (2) |
| 3 | (3) |
| 4 | (4) |
| 5 = 12 | (PE) |

6-fach / 6 ways

- | | |
|-------------------|------|
| 1 = 11 | (+) |
| 3 = 9 gebrückt 10 | (-) |
| 4 = 1 | (1) |
| 2 | (2) |
| 3 | (3) |
| 4 | (4) |
| 5 | (5) |
| 6 | (6) |
| 5 = 12 | (PE) |





8-fach / 8 ways

- | | |
|-------------------|------|
| 1 = 11 | (+) |
| 3 = 9 gebrückt 10 | (-) |
| 4 = 1 | (1) |
| 2 | (2) |
| 3 | (3) |
| 4 | (4) |
| 5 | (5) |
| 6 | (6) |
| 7 | (7) |
| 8 | (8) |
| 5 = 12 | (PE) |

Aktor-Sensor-Verteiler
Actuator/Sensor distribution boxes

Temperaturbereich	- 15°C / + 90°C
Werkstoffe	
Gehäuse	TPU, selbstverlöschend
Kontaktträger	PA 6.6 GF, selbstverlöschend
Kontakt	CuZn, unternickelt und 0,8 µm vergoldet
Gewindebuchse	CuZn, vernickelt
O-Ring	FKM
Mechanische Daten	
Schutzart	IP 67 Nur im verschraubten Zustand mit den dazugehörigen Gegenstücken.
Elektrische Daten	
Durchgangswiderstand	≤ 5 m Ω
Strombelastbarkeit	4 A pro Steckplatz / 12 A max. gesamt
Betriebsspannung	10 - 30 V DC
Bemessungsspannung	32 V eff.
Isolationswiderstand	> 10 ⁹ Ω
Verschmutzungsgrad	2 nach VDE 0110
Zubehör (inkl.)	
ZVK	2 Schutzkappen für nicht belegte Kupplungsgehäuse
ZBS	10 Beschriftungsschilder

Temperature range	- 15°C / + 90°C
Materials	
Housing	TPU, self-extinguishing
Moulded body	PA 6.6 GF, self-extinguishing
Contact	CuZn, pre-nickel and 0.8 microns gold-plated
Threaded sleeve	CuZn, brass, nicked
O-Ring	FKM
Mechanical data	
Protection	IP 67 Only in fully locked position with its plugs.
Electrical data	
Contact resistance	≤ 5 m Ω
Nominal power	4 A per outlet / 12 A max. total
Nominal voltage	10 - 30 V DC
Measurement voltage	32 V eff.
Insulation resistance	> 10 ⁹ Ω
Pollution grade	2 acc. to VDE 0110
Accessories (incl.)	
ZVK	2 Dust covers for unused sockets
ZBS	10 Attachable molds

Bestellbezeichnung Part no.	Polzahl Poles		
ASBS 4/LED 5-4	4		
ASBS 6/LED 5-4	4		
ASBS 8/LED 5-4	4	