

# Ultra Low Profile Stacker: BTB

00-9258

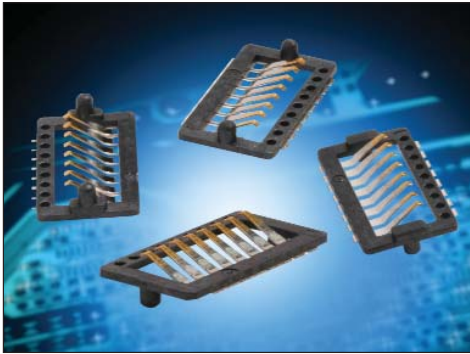

The SOLO series 9258 is a one-piece connector used to connect two PCBs in a cost effective manner.

This connector is a 1.0mm pitch available in an 8 position with stack heights of 0.40mm and 0.80mm. It is available with or without location bosses.

This connector is designed for PCB surface mounting and is supplied in tape and reel packaging. Gold plated pads on the mating PCB or suitable flex circuits provide connection between the boards.

## APPLICATIONS

- Mobile phones
- Handheld scanners
- Portable medical devices
- Display interface

## FEATURES AND BENEFITS

Single piece connector – no mating half connector required to connect two boards together which means:

- Reduced assembly time
- Only one part to purchase and stock
- Due to the unique contact design, the mating device does not have to be parallel
- Extremely robust when it comes to shock and vibration

## ELECTRICAL

- Current Rating: 1 Amp/Contact
- Voltage Rating: 125V  
Based on placement distance

## ENVIRONMENTAL

- Operating Temperature:  
-55°C to +125°C

## MECHANICAL

- Insulator Material: High Temperature Plastic; UL94 V-0
- Contact Material: Beryllium Copper
- Plating: Gold over Nickel
- Durability: 50 Cycles

## HOW TO ORDER

**00** Prefix  
**9258** Series  
**008** Number of Ways  
008 = 8

**00X** Connector Height

Code	Stack Height	Contact Height	Qty
004	0.40mm	1.00-1.30	No. of Ways
008	0.80mm	1.40-1.70	

**06** Plating Variation  
06 = Selective Gold  
0.25µm Gold Plated  
Contact Nose Pure  
Tin Tail

**X** PCB Location Bosses  
1 = With PCB Location Bosses (top side)  
2 = Without PCB Location Bosses  
3 = With SMT PCB Location Bosses (bottom side)  
4 = With SMT and Mating PCB Location Bosses (top and bottom side)



# Ultra Low Profile Stacker: BTB

00-9258



## 0.4MM ULTRA LOW PROFILE STACKER

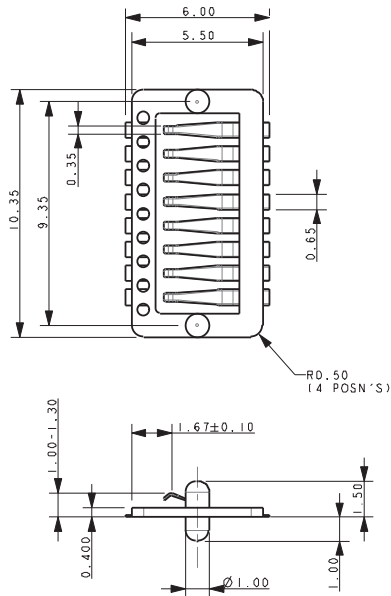

### NOTES:

1. 8 WAY ULTRA LOW PROFILE STACKER IN 0.8MM STACK HEIGHT.
2. INSULATOR MATERIAL: NYLON 46 HF5040, 40% GLASS FILLED UL94 V-0. COLOR BLACK.
3. CONTACT MATERIAL; 0.10MM THICK BeCu.
4. CONTACT PLATING: NICKEL UNDERPLATE, SELECTIVE GOLD PLATED CONTACT NOSES PURE TIN PLATED CONTACT SMT TAILS.
5. PARTS TO BE PACKED IN TAPE AND REEL, QTY: 1200.
6. ALL DIMENSIONS FOR REFERENCE UNLESS TOLERANCED.
7. FOR FURTHER INFORMATION REFER TO SPECIFICATION 201-01-115.

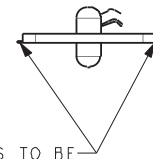
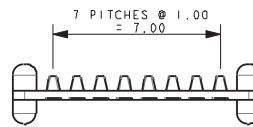

ALL TAILS TO BE WITHIN 0.10 MAX COPLANARITY TOLERANCE

### PROPOSED SMT PCB LAYOUT

ALL PADS PURE TIN PLATE

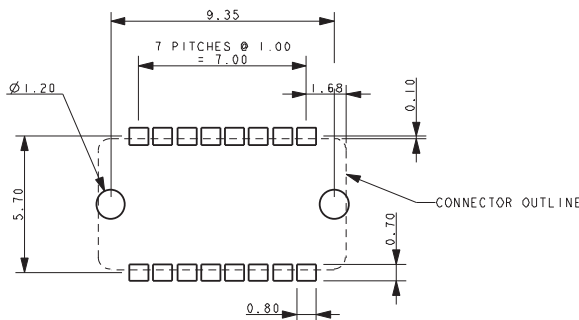

### WITH MATING PCB LOCATION BOSSES

(TOP SIDE)

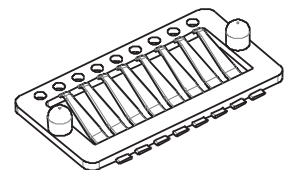

### WITHOUT PCB LOCATION BOSSES

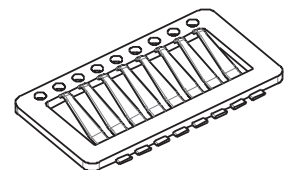

### PROPOSED MATING PCB LAYOUT

ALL PADS GOLD PLATE

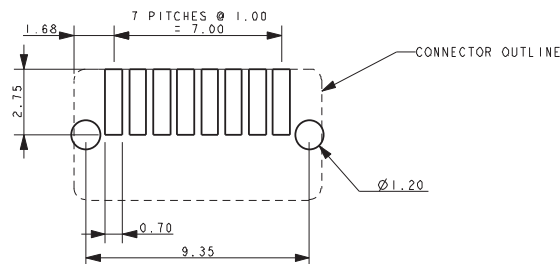

### WITH SMT PCB LOCATION BOSSES

(BOTTOM SIDE)

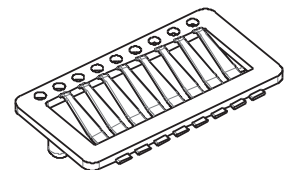

### PACKING TAPE DETAILS

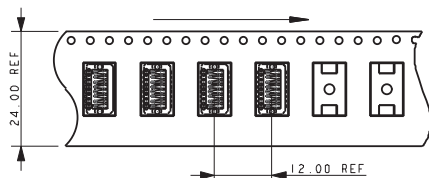

### WITH PCB AND SMT LOCATION BOSSES

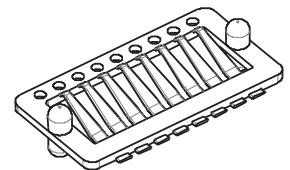

# Ultra Low Profile Stacker: BTB

00-9258



## 0.8MM ULTRA LOW PROFILE STACKER

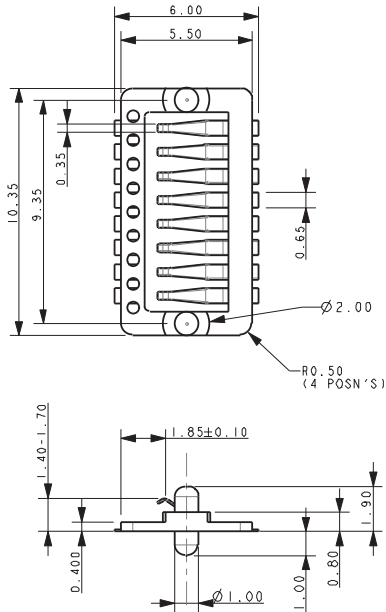

### NOTES:

1. 8 WAY ULTRA LOW PROFILE STACKER IN 0.4MM STACK HEIGHT.
2. INSULATOR MATERIAL: NYLON 46 HF5040, 40% GLASS FILLED UL94 V-0. COLOR BLACK.
3. CONTACT MATERIAL; 0.10MM THICK BeCu.
4. CONTACT PLATING: NICKEL UNDERPLATE, SELECTIVE GOLD PLATED CONTACT NOSES PURE TIN PLATED CONTACT SMT TAILS.
5. PARTS TO BE PACKED IN TAPE AND REEL, QTY: 1400.
6. ALL DIMENSIONS FOR REFERENCE UNLESS TOLERANCED.
7. FOR FURTHER INFORMATION REFER TO SPECIFICATION 201-01-115.

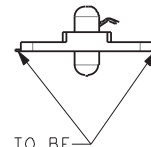
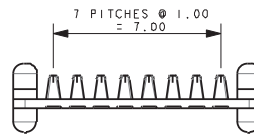

ALL TAILS TO BE WITHIN 0.10 MAX COPLANARITY TOLERANCE

### PROPOSED SMT PCB LAYOUT

ALL PADS PURE TIN PLATE

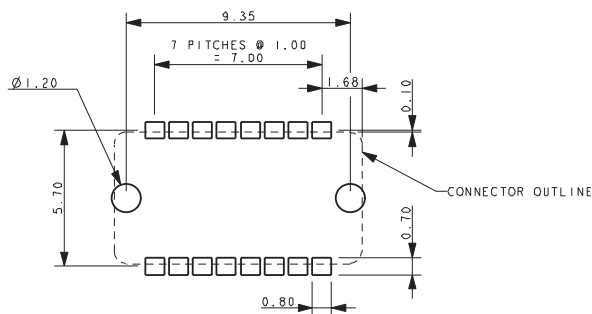

### WITH MATING PCB LOCATION BOSSES

(TOP SIDE)

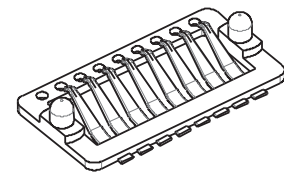

### PROPOSED MATING PCB LAYOUT

ALL PADS GOLD PLATE

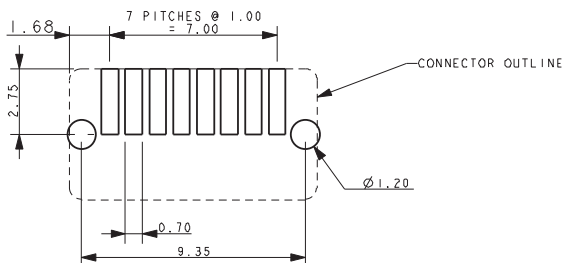

### WITHOUT PCB LOCATION BOSSES

### WITH SMT PCB LOCATION BOSSES

(BOTTOM SIDE)

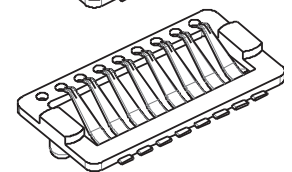
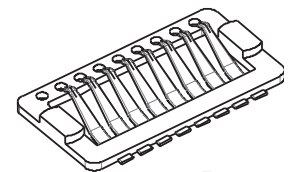

### PACKING TAPE DETAILS

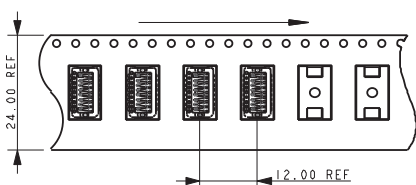

### WITH PCB AND SMT LOCATION BOSSES

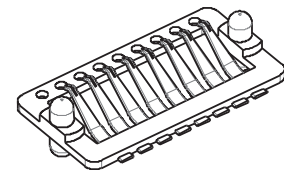

# Mouser Electronics

Authorized Distributor

Click to View Pricing, Inventory, Delivery & Lifecycle Information:

## KYOCERA AVX:

[009258008008063](#) [009258008004062](#) [009258008008061](#) [009258008004064](#) [009258008004061](#)  
[009258008004063](#) [009258008008062](#) [009258008008064](#)