

LOW PROFILE IDC 22-30 AWG: 9176-800

General Information

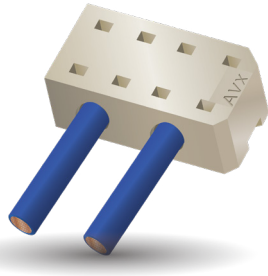

GENERAL DESCRIPTION

KYOCERA AVX industrial/transportation grade insulation displacement connectors (IDC) have been proven in the market for over ten years. Providing a very simple one-step termination process, these connectors proved a robust wire-to-board (WTB) termination in harsh applications.

The 9176-800 series has been developed specifically for 22-26AWG discrete wires in size critical applications. By reducing the "Z" axis height by 1.0mm and the overall volume by up to 50%, this new package size is an ideal choice in space constrained applications over previous IDC connectors. In addition, an expanded size range is available starting from a 1 position up to 4 positions in each wire gauge. The entire range provides new packaging solutions in industrial, medical and transportation applications such as smart metering, LED lighting, industrial controls and portable monitoring and measurement devices.

APPLICATIONS

- Connecting discrete wires and components to a PCB
- Bringing power and signals onto a PCB
- Daisy chaining or interconnecting PCB's together
- Application Notes: Refer to 201-01-216

FEATURES AND BENEFITS

- Redundant and fatigue resistant phosphor bronze material provides a gas tight, cold welded connection to the wire
- IDC connectors can be potted or over molded to encapsulate electronic modules and provide environmental protection
- The 1p version is available in industry standard colors to match individual wires for error free wire termination

ELECTRICAL

- Current Rating: 22AWG: 7 amps
24AWG: 6 amps
26AWG: 5 amps
28AWG: 4 amps
30AWG: 3 amps
- Voltage Rating: 1p: 600V
2p-4p: 100V
- Durability: 1 Cycle

ENVIRONMENTAL

- Operating Temperature: -40°C to +125°C

MECHANICAL

- Insulator Material: Glass-Filled Nylon 46; UL94V0
- Contact Material: Phosphor Bronze
- Plating: Lead-Free Tin Over Nickel

HOW TO ORDER

00
Prefix
Wire to Board
Connector

9176
Series

00X
Number of Ways
001 = 1
002 = 2
003 = 3
004 = 4

8XX
Wire Gauge Size

Code	Accepted Wire Gauge	Maximum Wire Isulation Diameter	UL Approved
853	22AWG Solid and Stranded	1.40	Approved
863	24AWG Solid and Stranded	1.40	Approved
873	26AWG Solid and Stranded	1.40	Approved
883	28AWG Solid and Stranded	0.80 to 1.40	Approved
884	28AWG Solid and Stranded	0.80	Approved
893	30AWG Solid and Stranded	0.80 to 1.40	Approved
894	30AWG Solid and Stranded	0.80	Approved

X
Insulator Color
9 = White Standard
Solid Colors (1p only)
2 = Brown
3 = Blue
4 = Yellow
5 = Red
6 = Green
7 = Orange
8 = Black

06
Plating Option
06 = Pure Tin
All Over Nickel

Certification: UL File #E90723

LOW PROFILE IDC 22-30 AWG: 9176-800

1 Position

00-9176-001-8XX-X06

1 WAY

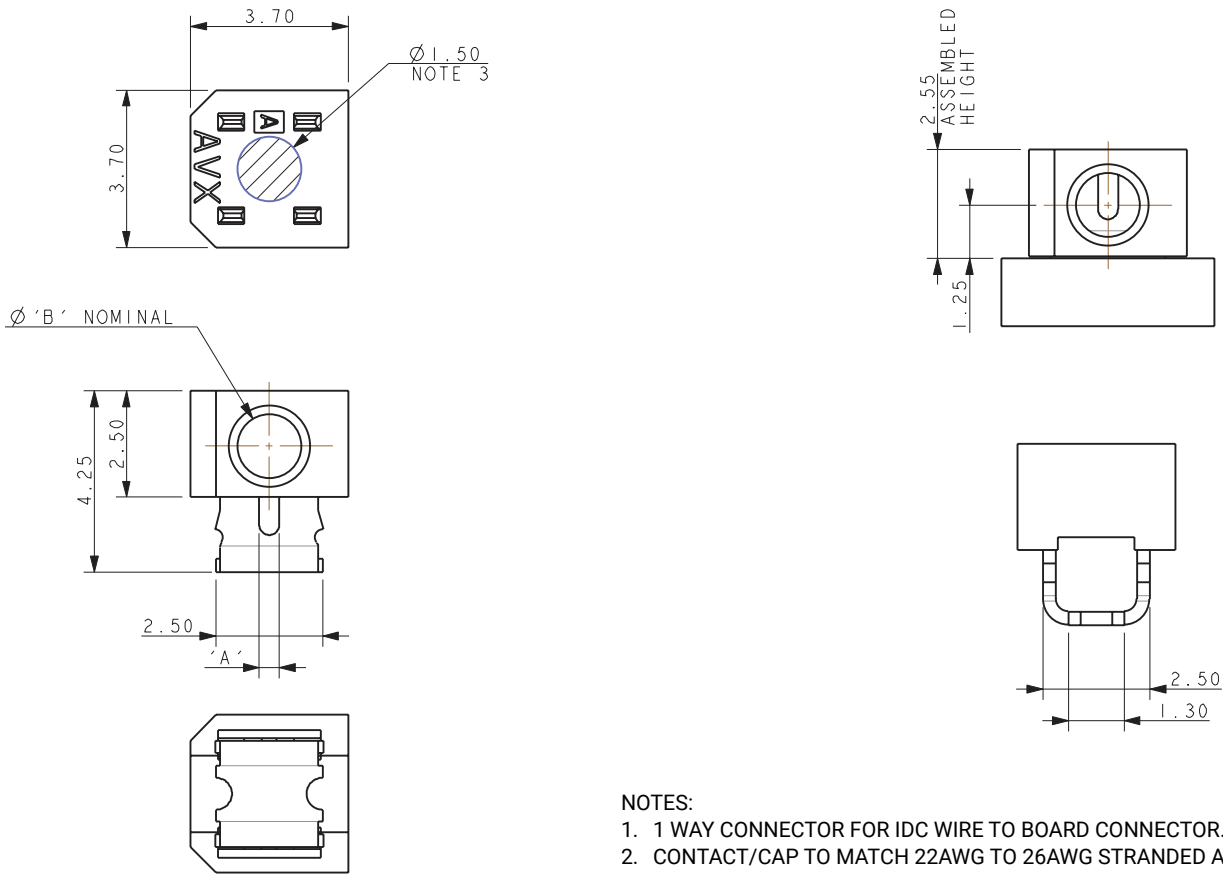

NOTES:

1. 1 WAY CONNECTOR FOR IDC WIRE TO BOARD CONNECTOR.
2. CONTACT/CAP TO MATCH 22AWG TO 26AWG STRANDED AND SOLID WIRE, MAXIMUM INSULATOR 1.40 DIAMETER
3. FLAT FACE ON TOP OF CAP TO AID PICK AND PLACE ASSEMBLY.
4. FOR FULL PRODUCT SPECIFICATION REFER TO KYOCERA AVX SPEC 201-01-215.
5. ASSEMBLY PROCEDURE, REFER TO APPLICATION NOTES 201-01-216.
6. GENERAL TOLERANCE ± 0.20 UNLESS STATED.
7. PACKED IN TAPE AND REEL, QUANTITY PER REEL 1700.
8. CONNECTOR OUTLINE.
9. CONTACT MATERIAL: TIN PLATED COPPER ALLOY.
10. INSULATOR MATERIAL: HIGH TEMPERATURE NYLON, GLASS FILLED. UL94 V-0, COLOR REFER TO PAGE 54.
11. UL REFERENCE E90723 (US AND CANADA).

PART NUMBER See page 54	WIRE GAUGE	B	A
00-9176-001-853-X06	22AWG Solid and Stranded	1.50	0.47
00-9176-001-863-X06	24AWG Solid and Stranded	1.50	0.37
00-9176-001-873-X06	26AWG Solid and Stranded	1.50	0.28
00-9176-001-883-X06	28AWG Solid and Stranded	1.50	0.20
00-9176-001-884-X06	28AWG Solid and Stranded	0.90	0.20
00-9176-001-893-X06	30AWG Solid and Stranded	1.50	0.20
00-9176-001-894-X06	30AWG Solid and Stranded	0.90	0.20

SUGGESTED PCB LAYOUT

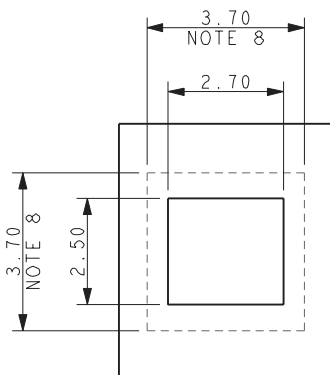

PACKING DETAILS

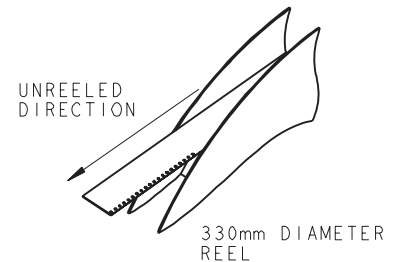
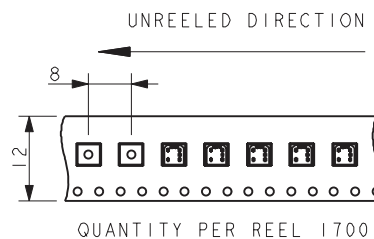

LOW PROFILE IDC 22-30 AWG: 9176-800

2 Position

00-9176-001-8XX-X06

2 WAY

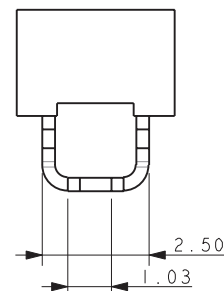
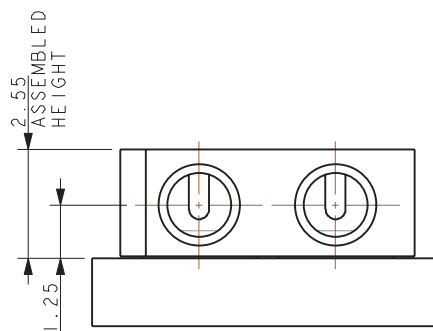
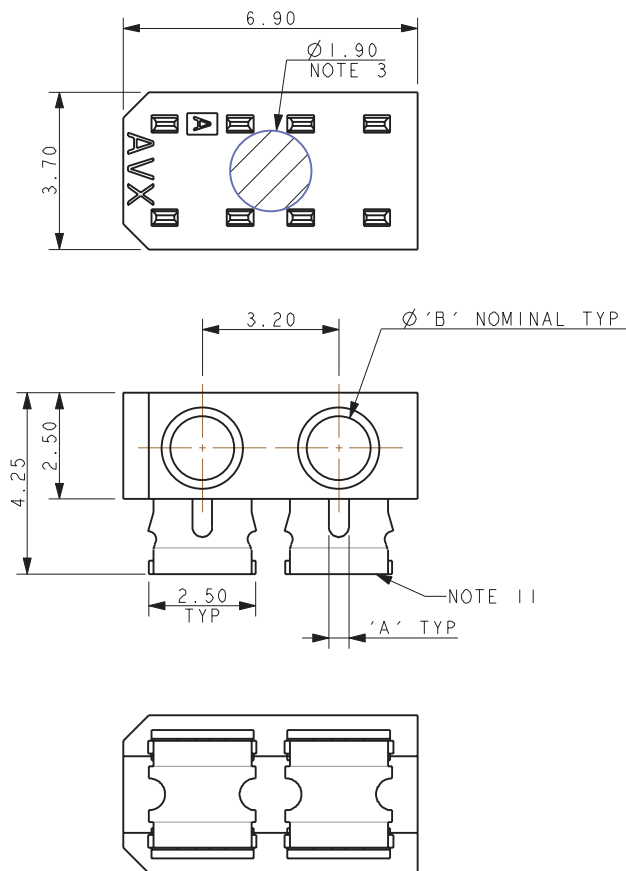

NOTES:

- 2 WAY CONNECTOR FOR IDC WIRE TO BOARD CONNECTOR.
- CONTACT/CAP TO MATCH 22AWG TO 26AWG STRANDED AND SOLID WIRE, MAXIMUM INSULATOR 1.40 DIAMETER
- FLAT FACE ON TOP OF CAP TO AID PICK AND PLACE ASSEMBLY.
- FOR FULL PRODUCT SPECIFICATION REFER TO KYOCERA AVX SPEC 201-01-215.
- ASSEMBLY PROCEDURE, REFER TO APPLICATION NOTES 201-01-216.
- GENERAL TOLERANCE ± 0.20 UNLESS STATED.
- PACKED IN TAPE AND REEL, QUANTITY PER REEL 1700.
- CONNECTOR OUTLINE.
- CONTACT MATERIAL: TIN PLATED COPPER ALLOY.
- INSULATOR MATERIAL: HIGH TEMPERATURE NYLON, GLASS FILLED. UL94 V-0, COLOR REFER TO PAGE 54.
- UL REFERENCE E90723 (US AND CANADA).

PART NUMBER See page 54	WIRE GAUGE	B	A
00-9176-002-853-X06	22AWG Solid and Stranded	1.50	0.47
00-9176-002-863-X06	24AWG Solid and Stranded	1.50	0.37
00-9176-002-873-X06	26AWG Solid and Stranded	1.50	0.28
00-9176-002-883-X06	28AWG Solid and Stranded	1.50	0.20
00-9176-002-884-X06	28AWG Solid and Stranded	0.90	0.20
00-9176-002-893-X06	30AWG Solid and Stranded	1.50	0.20
00-9176-002-894-X06	30AWG Solid and Stranded	0.90	0.20

SUGGESTED PCB LAYOUT

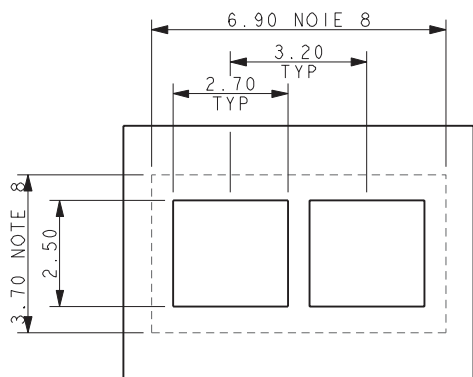

PACKING DETAILS

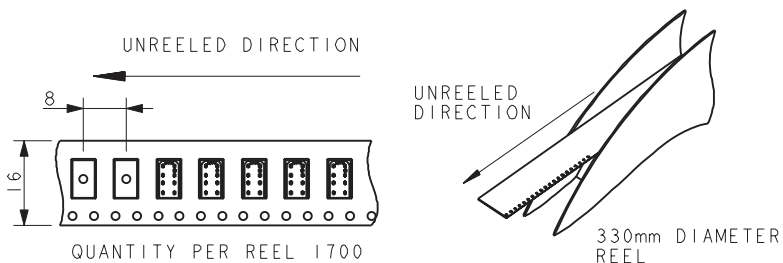

LOW PROFILE IDC 22-30 AWG: 9176-800

3 Position



00-9176-001-8XX-X06

3 WAY

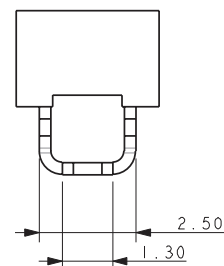
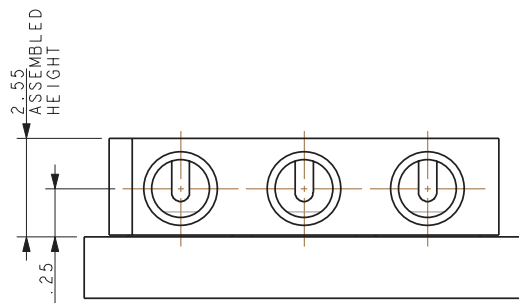
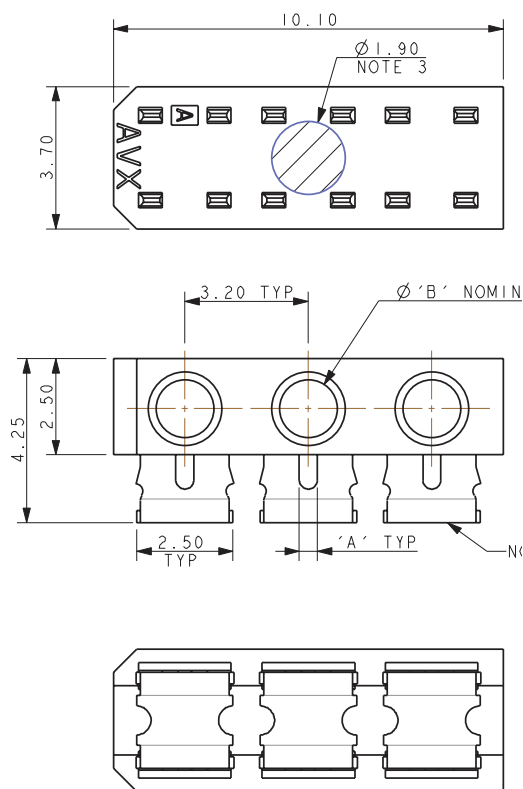

NOTES:

- 3 WAY CONNECTOR FOR IDC WIRE TO BOARD CONNECTOR.
- CONTACT/CAP TO MATCH 22AWG TO 26AWG STRANDED AND SOLID WIRE, MAXIMUM INSULATOR 1.40 DIAMETER
- FLAT FACE ON TOP OF CAP TO AID PICK AND PLACE ASSEMBLY.
- FOR FULL PRODUCT SPECIFICATION REFER TO KYOCERA AVX SPEC 201-01-215.
- ASSEMBLY PROCEDURE, REFER TO APPLICATION NOTES 201-01-216.
- GENERAL TOLERANCE ± 0.20 UNLESS STATED.
- PACKED IN TAPE AND REEL, QUANTITY PER REEL 1700.
- CONNECTOR OUTLINE.
- CONTACT MATERIAL: TIN PLATED COPPER ALLOY.
- INSULATOR MATERIAL: HIGH TEMPERATURE NYLON, GLASS FILLED. UL94 V-0, COLOR REFER TO PAGE 54.
- UL REFERENCE E90723 (US AND CANADA).

PART NUMBER See page 54	WIRE GAUGE	B	A
00-9176-003-853-X06	22AWG Solid and Stranded	1.50	0.47
00-9176-003-863-X06	24AWG Solid and Stranded	1.50	0.37
00-9176-003-873-X06	26AWG Solid and Stranded	1.50	0.28
00-9176-003-883-X06	28AWG Solid and Stranded	1.50	0.20
00-9176-003-884-X06	28AWG Solid and Stranded	0.90	0.20
00-9176-003-893-X06	30AWG Solid and Stranded	1.50	0.20
00-9176-003-894-X06	30AWG Solid and Stranded	0.90	0.20

SUGGESTED PCB LAYOUT

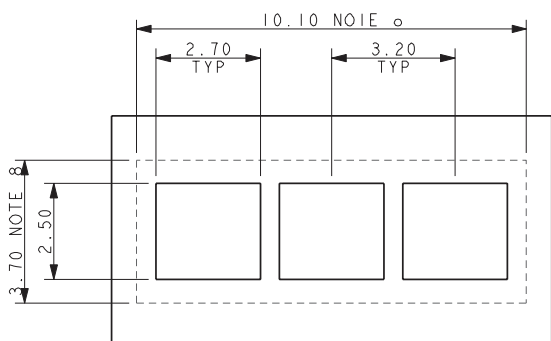

PACKING DETAILS

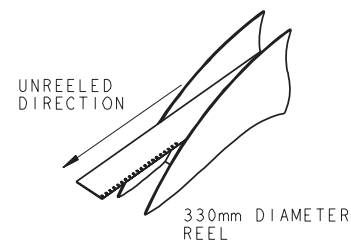
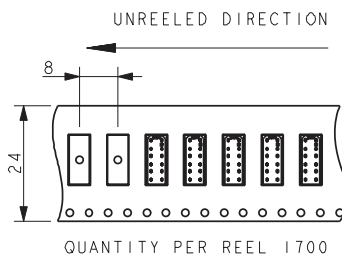

LOW PROFILE IDC 22-30 AWG: 9176-800

4 Position

00-9176-001-8X3-X06

4 WAY

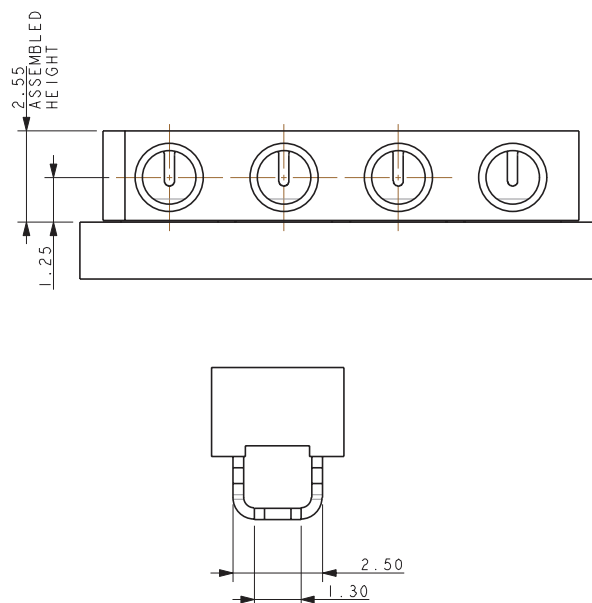
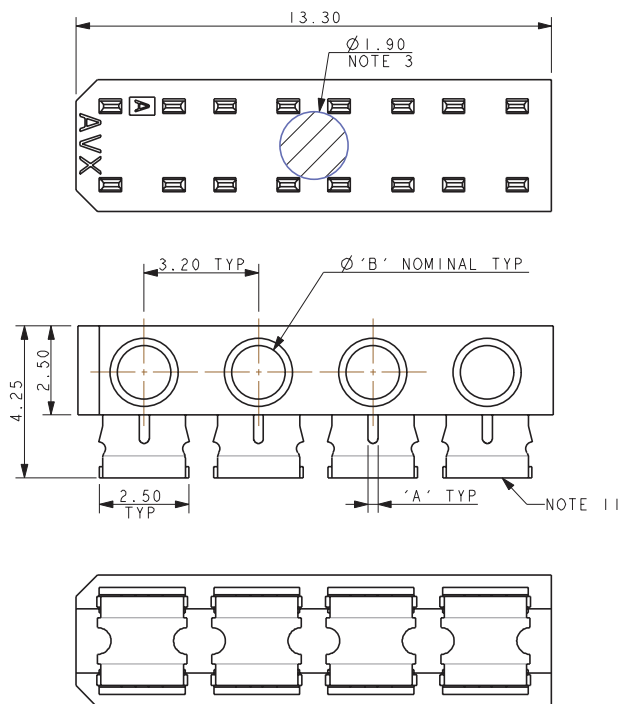

PART NUMBER See page 54	WIRE GAUGE	B	A
00-9176-004-853-X06	22AWG Solid and Stranded	1.50	0.47
00-9176-004-863-X06	24AWG Solid and Stranded	1.50	0.37
00-9176-004-873-X06	26AWG Solid and Stranded	1.50	0.28
00-9176-004-883-X06	28AWG Solid and Stranded	1.50	0.20
00-9176-004-884-X06	28AWG Solid and Stranded	0.90	0.20
00-9176-004-893-X06	30AWG Solid and Stranded	1.50	0.20
00-9176-004-894-X06	30AWG Solid and Stranded	0.90	0.20

NOTES:

- 4 WAY CONNECTOR FOR IDC WIRE TO BOARD CONNECTOR.
- CONTACT/CAP TO MATCH 22AWG TO 26AWG STRANDED AND SOLID WIRE, MAXIMUM INSULATOR 1.40 DIAMETER
- FLAT FACE ON TOP OF CAP TO AID PICK AND PLACE ASSEMBLY.
- FOR FULL PRODUCT SPECIFICATION REFER TO KYOCERA AVX SPEC 201-01-215.
- ASSEMBLY PROCEDURE, REFER TO APPLICATION NOTES 201-01-216.
- GENERAL TOLERANCE ± 0.20 UNLESS STATED.
- PACKED IN TAPE AND REEL, QUANTITY PER REEL 1700.
- CONNECTOR OUTLINE.
- CONTACT MATERIAL: TIN PLATED COPPER ALLOY.
- INSULATOR MATERIAL: HIGH TEMPERATURE NYLON, GLASS FILLED. UL94 V-0, COLOR REFER TO PAGE 54.
- UL REFERENCE E90723 (US AND CANADA).

SUGGESTED PCB LAYOUT

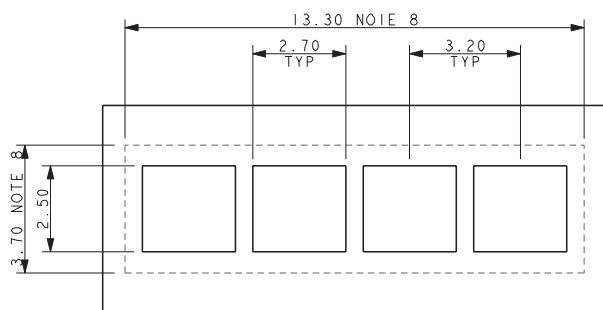

PACKING DETAILS

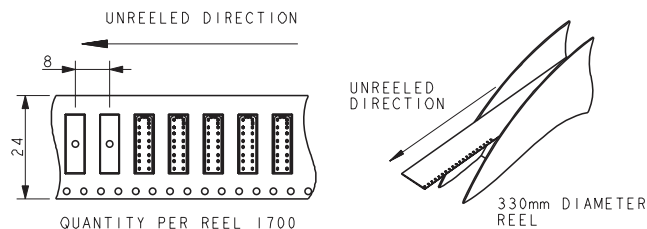

LOW PROFILE IDC 22-30 AWG: 9176-800

Conector Details

CONNECTOR DETAILS

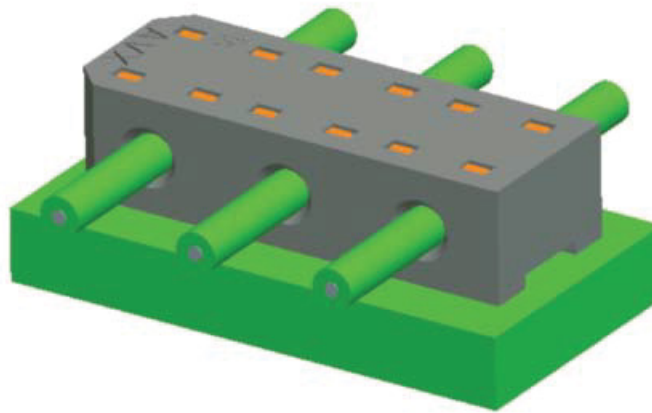
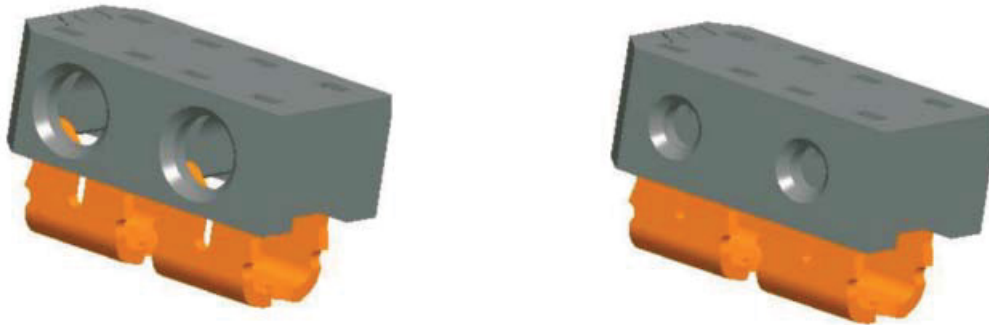

00-9176-00X-8X4-X06

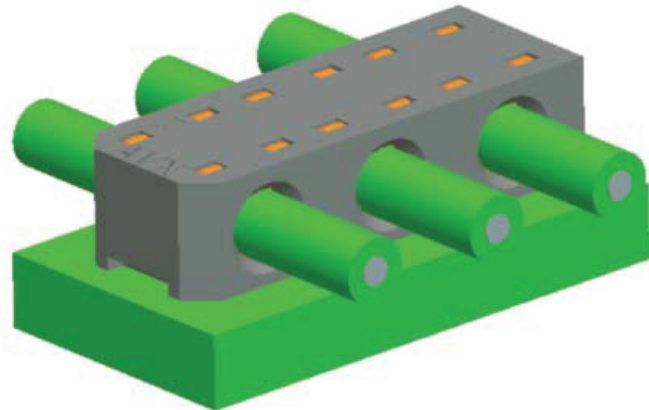

00-9176-00X-8X3-X06

Mouser Electronics

Authorized Distributor

Click to View Pricing, Inventory, Delivery & Lifecycle Information:

[Kyocera AVX:](#)

[009176002853906](#) [009176004863906](#) [009176003853906](#) [009176004853906](#) [009176003873906](#)
[009176004873906](#) [009176001853906](#) [009176003863906](#) [009176002863906](#) [009176001863906](#) [009176001873906](#)
[009176002873906](#) [009176004884906](#) [009176003884906](#) [009176002884906](#) [009176001884906](#)
[009176001863606](#) [009176001863806](#) [009176001863506](#) [009176003883906](#) [009176003893906](#) [009176001894906](#)
[009176004883906](#) [009176003894906](#) [009176001883906](#) [009176002883906](#) [009176004894906](#)
[009176004893906](#) [009176002894906](#) [009176002893906](#) [009176001853806](#)