



TC4420M/TC4429M

6A High-Speed MOSFET Drivers

Features

- Latch-Up Protected: Will Withstand $>1.5A$ Reverse Output Current
- Logic Input: Will Withstand Negative Swing Up To 5V
- ESD Protected: 4 kV
- Matched Rise and Fall Times:
 - 25 ns (2500 pF load)
- High Peak Output Current: 6A
- Wide Input Supply Voltage Operating Range:
 - 4.5V to 18V
- High Capacitive Load Drive Capability: 10,000 pF
- Short Delay Time: 55 ns (typical)
- CMOS/TTL-Compatible Input
- Low Supply Current With Logic '1' Input:
 - 450 μA (typical)
- Low Output Impedance: 2.5Ω
- Output Voltage Swing to Within 25 mV of Ground or V_{DD}
- Wide Operating Temperature Range:
 - $-55^{\circ}C$ to $+125^{\circ}C$
- See TC4420/TC4429 Data Sheet (DS21419) for additional temperature range and package offerings.

Applications

- Switch-mode Power Supplies
- Motor Controls
- Pulse Transformer Driver
- Class D Switching Amplifiers

General Description

The TC4420M/TC4429M are 6A (peak), single-output MOSFET drivers. The TC4429M is an inverting driver (pin-compatible with the TC4420M), while the TC4420M is a non-inverting driver. These drivers are fabricated in CMOS for lower power and more efficient operation versus bipolar drivers.

Both devices have TTL/CMOS-compatible inputs, which can be driven as high as $V_{DD} + 0.3V$ or as low as $-5V$ without upset or damage to the device. This eliminates the need for external level-shifting circuitry and its associated cost and size. The output swing is rail-to-rail, ensuring better drive voltage margin, especially during power-up/power-down sequencing. The propagational delay time is only 55 ns (typical), while the output rise and fall times are only 25 ns (typical) into 2500 pF across the usable power supply range.

Unlike other drivers, the TC4420M/TC4429M are virtually latch-up proof. They replace three or more discrete components, saving PCB area and parts while improving overall system reliability.

Package Types:

8-Pin CERDIP

TC4420M

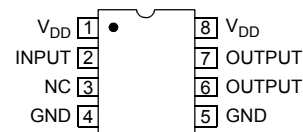

TC4429M

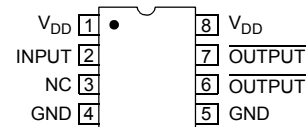

Note: Duplicate pins must both be connected for proper operation.

TC4420M/TC4429M

Functional Block Diagram

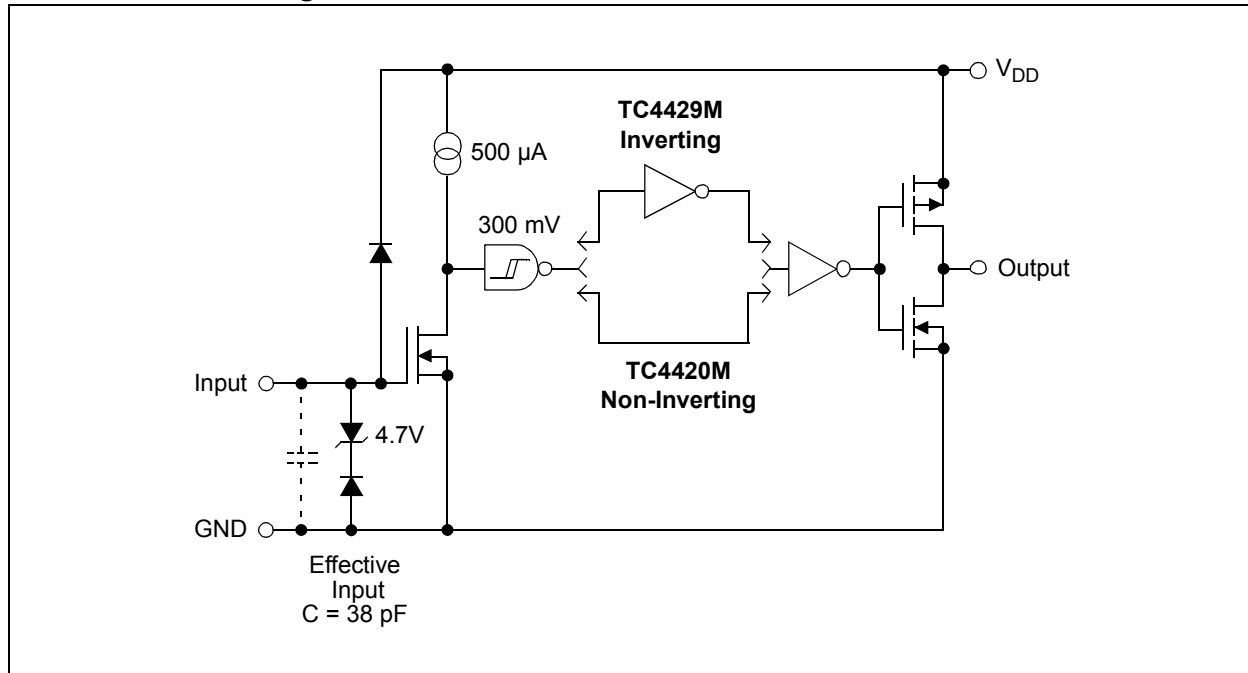

1.0 ELECTRICAL CHARACTERISTICS

Absolute Maximum Ratings†

Supply Voltage	+20V
Input Voltage	-5V to $V_{DD} + 0.3V$
Input Current ($V_{IN} > V_{DD}$).....	50 mA

† **Notice:** Stresses above those listed under “Absolute Maximum Ratings” may cause permanent damage to the device. These are stress ratings only and functional operation of the device at these or any other conditions above those indicated in the operation sections of the specifications is not implied. Exposure to Absolute Maximum Rating conditions for extended periods may affect device reliability.

DC CHARACTERISTICS

Electrical Specifications: Unless otherwise noted, $T_A = +25^\circ\text{C}$ with $4.5V \leq V_{DD} \leq 18V$.						
Parameters	Sym	Min	Typ	Max	Units	Conditions
Input						
Logic '1', High Input Voltage	V_{IH}	2.4	1.8	—	V	
Logic '0', Low Input Voltage	V_{IL}	—	1.3	0.8	V	
Input Voltage Range	V_{IN}	- 5	—	$V_{DD} + 0.3$	V	
Input Current	I_{IN}	-10	—	+10	μA	$0V \leq V_{IN} \leq V_{DD}$
Output						
High Output Voltage	V_{OH}	$V_{DD} - 0.025$	—	—	V	DC TEST
Low Output Voltage	V_{OL}	—	—	0.025	V	DC TEST
Output Resistance, High	R_{OH}	—	2.1	2.8	Ω	$I_{OUT} = 10 \text{ mA}$, $V_{DD} = 18V$
Output Resistance, Low	R_{OL}	—	1.5	2.5	Ω	$I_{OUT} = 10 \text{ mA}$, $V_{DD} = 18V$
Peak Output Current	I_{PK}	—	6.0	—	A	$V_{DD} = 18V$
Latch-Up Protection Withstand Reverse Current	I_{REV}	—	> 1.5	—	A	Duty cycle $\leq 2\%$, $t \leq 300 \mu\text{s}$
Switching Time (Note 1)						
Rise Time	t_R	—	25	35	ns.	Figure 4-1, $C_L = 2,500 \text{ pF}$
Fall Time	t_F	—	25	35	ns.	Figure 4-1, $C_L = 2,500 \text{ pF}$
Delay Time	t_{D1}	—	55	75	ns.	Figure 4-1
Delay Time	t_{D2}	—	55	75	ns.	Figure 4-1
Power Supply						
Power Supply Current	I_S	—	0.45	1.5	mA	$V_{IN} = 3V$
		—	55	150	μA	$V_{IN} = 0V$
Operating Input Voltage	V_{DD}	4.5	—	18	V	

Note 1: Switching times ensured by design.

TC4420M/TC4429M

DC CHARACTERISTICS (OVER OPERATING TEMPERATURE RANGE)

Electrical Specifications: Unless otherwise noted, over operating temperature range with $4.5V \leq V_{DD} \leq 18V$.						
Parameters	Sym	Min	Typ	Max	Units	Conditions
Input						
Logic '1', High Input Voltage	V_{IH}	2.4	—	—	V	
Logic '0', Low Input Voltage	V_{IL}	—	—	0.8	V	
Input Voltage Range	V_{IN}	-5	—	$V_{DD} + 0.3$	V	
Input Current	I_{IN}	-10	—	+10	μA	$0V \leq V_{IN} \leq V_{DD}$
Output						
High Output Voltage	V_{OH}	$V_{DD} - 0.025$	—	—	V	DC TEST
Low Output Voltage	V_{OL}	—	—	0.025	V	DC TEST
Output Resistance, High	R_{OH}	—	3	5	Ω	$I_{OUT} = 10 \text{ mA}$, $V_{DD} = 18V$
Output Resistance, Low	R_{OL}	—	2.3	5	Ω	$I_{OUT} = 10 \text{ mA}$, $V_{DD} = 18V$
Switching Time (Note 1)						
Rise Time	t_R	—	32	60	ns.	Figure 4-1, $C_L = 2,500 \text{ pF}$
Fall Time	t_F	—	34	60	ns.	Figure 4-1, $C_L = 2,500 \text{ pF}$
Delay Time	t_{D1}	—	50	100	ns.	Figure 4-1
Delay Time	t_{D2}	—	65	100	ns.	Figure 4-1
Power Supply						
Power Supply Current	I_S	—	0.45	3	mA	$V_{IN} = 3V$
		—	60	400	μA	$V_{IN} = 0V$
Operating Input Voltage	V_{DD}	4.5	—	18	V	

Note 1: Switching times ensured by design.

TEMPERATURE CHARACTERISTICS

Electrical Specifications: Unless otherwise noted, all parameters apply with $4.5V \leq V_{DD} \leq 18V$.						
Parameters	Sym	Min	Typ	Max	Units	Conditions
Temperature Ranges						
Specified Temperature Range (M)	T_A	-55	—	+125	$^{\circ}C$	
Maximum Junction Temperature	T_J	—	—	+150	$^{\circ}C$	
Storage Temperature Range	T_A	-65	—	+150	$^{\circ}C$	
Package Thermal Resistances						
Thermal Resistance, 8L-CERDIP	θ_{JA}	—	150	—	$^{\circ}C/W$	

2.0 TYPICAL PERFORMANCE CURVES

Note: The graphs and tables provided following this note are a statistical summary based on a limited number of samples and are provided for informational purposes only. The performance characteristics listed herein are not tested or guaranteed. In some graphs or tables, the data presented may be outside the specified operating range (e.g., outside specified power supply range) and therefore outside the warranted range.

Note: Unless otherwise indicated, $T_A = +25^\circ\text{C}$ with $4.5\text{V} \leq V_{DD} \leq 18\text{V}$.

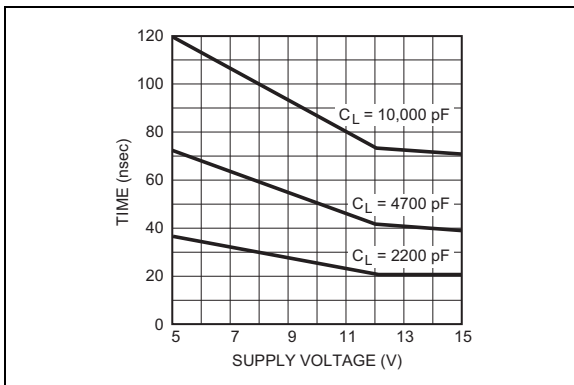

FIGURE 2-1: Rise Time vs. Supply Voltage.

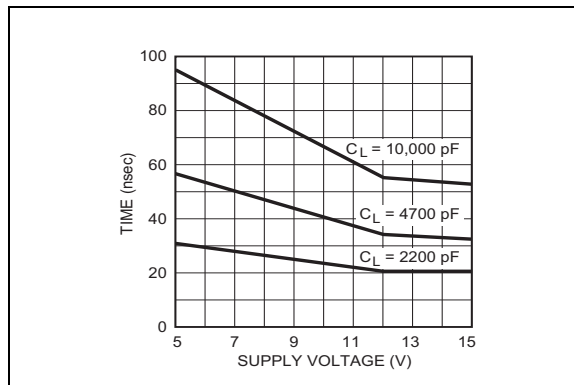

FIGURE 2-4: Fall Time vs. Supply Voltage.

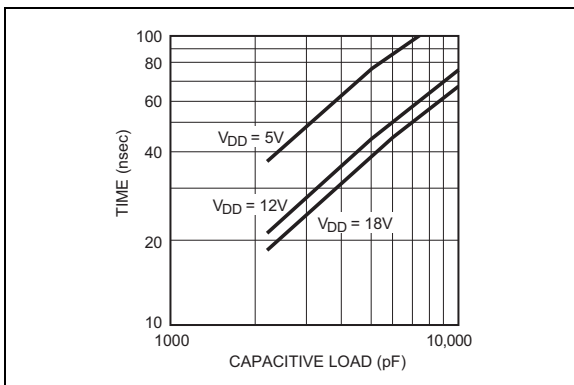

FIGURE 2-2: Rise Time vs. Capacitive Load.

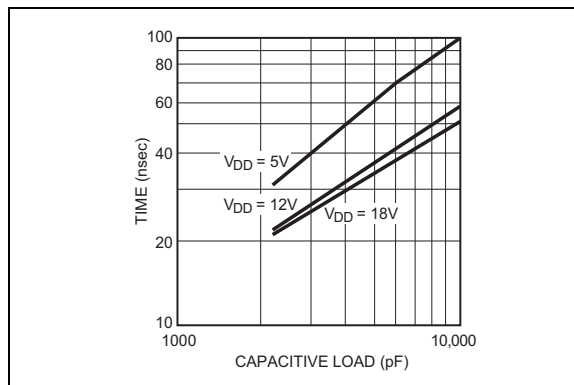

FIGURE 2-5: Fall Time vs. Capacitive Load.

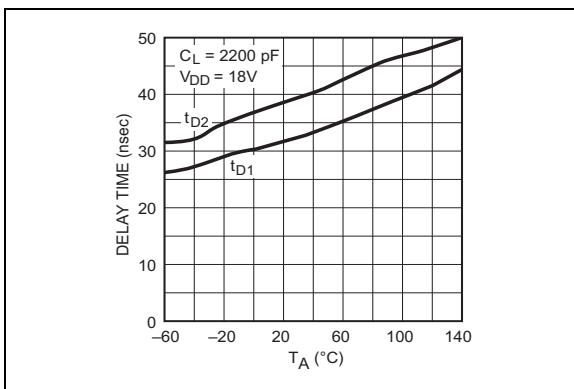

FIGURE 2-3: Propagation Delay Time vs. Temperature.

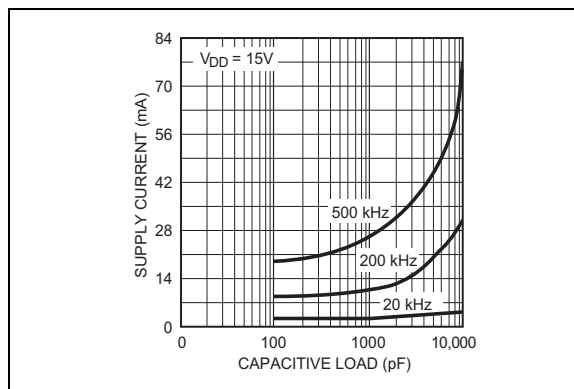

FIGURE 2-6: Supply Current vs. Capacitive Load.

TC4420M/TC4429M

Note: Unless otherwise indicated, $T_A = +25^\circ\text{C}$ with $4.5\text{V} \leq V_{DD} \leq 18\text{V}$.

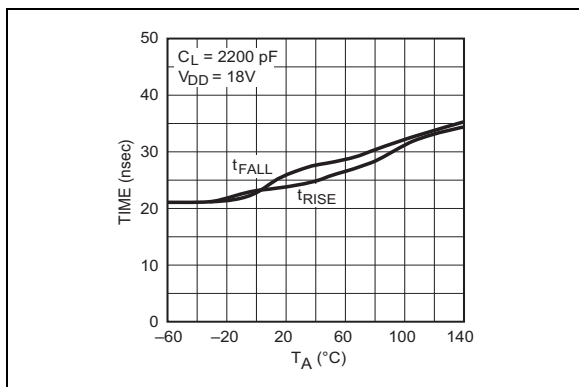

FIGURE 2-7: Rise and Fall Times vs. Temperature.

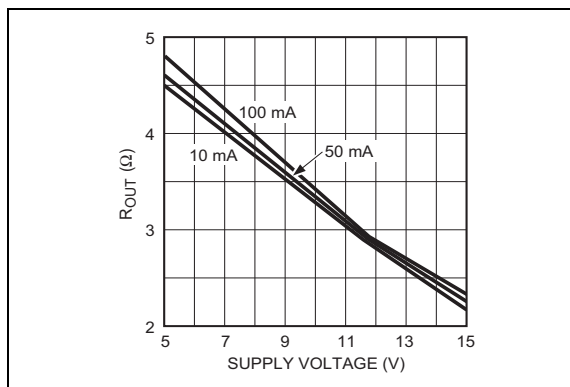

FIGURE 2-10: High-State Output Resistance vs. Supply Voltage.

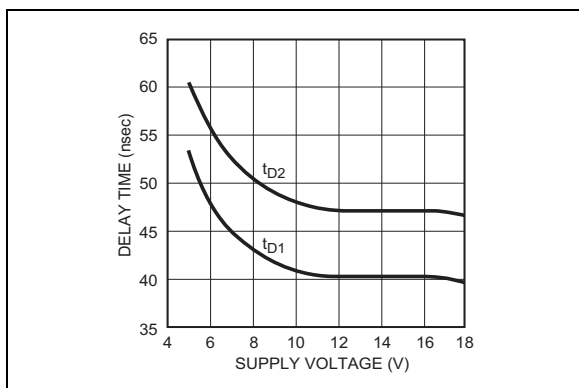

FIGURE 2-8: Propagation Delay Time vs. Supply Voltage.

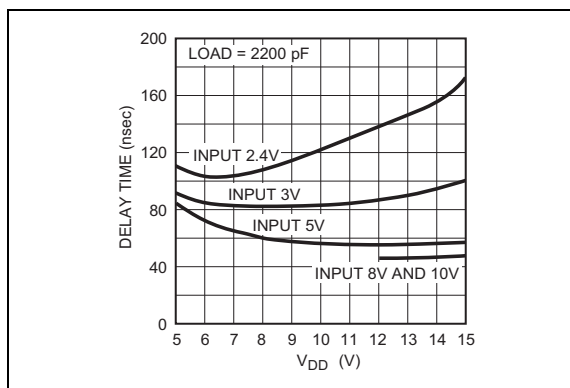

FIGURE 2-11: Effect of Input Amplitude on Propagation Delay.

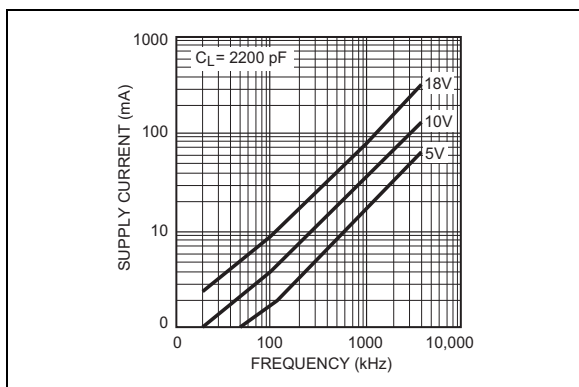

FIGURE 2-9: Supply Current vs. Frequency.

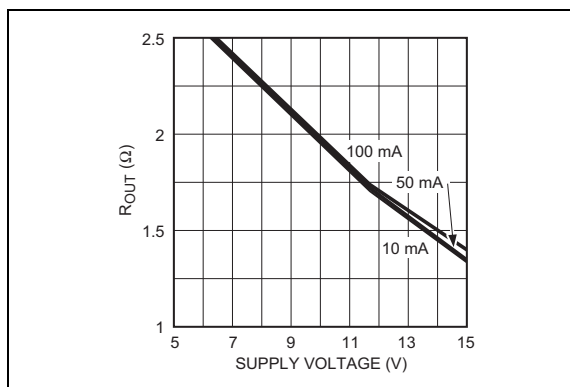

FIGURE 2-12: Low-State Output Resistance vs. Supply Voltage.

Note: Unless otherwise indicated, $T_A = +25^\circ\text{C}$ with $4.5\text{V} \leq V_{DD} \leq 18\text{V}$.

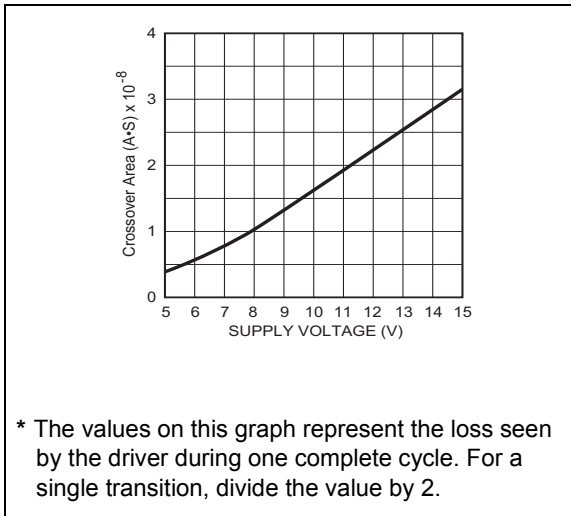

FIGURE 2-13: Crossover Energy*.

TC4420M/TC4429M

3.0 PIN DESCRIPTIONS

The descriptions of the pins are listed in [Table 3-1](#).

TABLE 3-1: PIN FUNCTION TABLE

Pin No. 8-Pin CERDIP	Symbol	Description
1	V _{DD}	Supply input, 4.5V to 18V
2	INPUT	Control input, TTL/CMOS compatible input
3	NC	No Connection
4	GND	Ground
5	GND	Ground
6	OUTPUT	CMOS push-pull output
7	OUTPUT	CMOS push-pull output
8	V _{DD}	Supply input, 4.5V to 18V

3.1 Supply Input (V_{DD})

The V_{DD} input is the bias supply for the MOSFET driver and is rated for 4.5V to 18V with respect to the ground pins. The V_{DD} input should be bypassed to ground with a local ceramic capacitor. The value of the capacitor should be chosen based on the capacitive load that is being driven. A minimum value of 1.0 μ F is suggested.

3.2 Control Input

The MOSFET driver input is a high-impedance, TTL/CMOS-compatible input. The input circuitry of the TC4420M/TC4429M MOSFET driver also has a “speed-up” capacitor. This helps to decrease the propagation delay times of the driver. Because of this, input signals with slow rising or falling edges should not be used, as this can result in double-pulsing of the MOSFET driver output.

3.3 CMOS Push-Pull Output

The MOSFET driver output is a low-impedance, CMOS, push-pull style output capable of driving a capacitive load with 6.0A peak currents. The MOSFET driver output is capable of withstanding 1.5A peak reverse currents of either polarity.

3.4 Ground

The ground pins are the return path for the bias current and the high peak currents that discharge the load capacitor. The ground pins should be tied into a ground plane or have very short traces to the bias supply source return.

4.0 APPLICATIONS INFORMATION

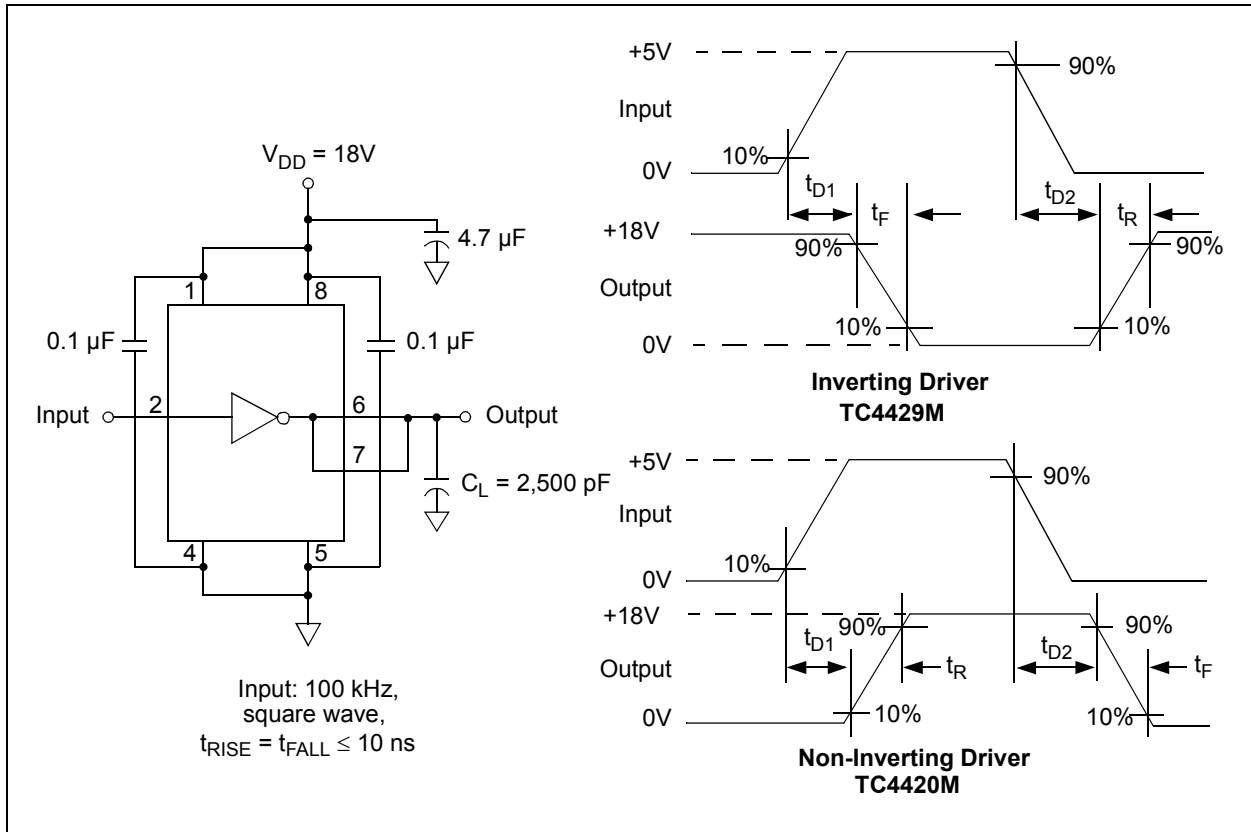

FIGURE 4-1: Switching Time Test Circuits.

TC4420M/TC4429M

5.0 PACKAGING INFORMATION

5.1 Package Marking Information

8-Lead CERDIP (.300")

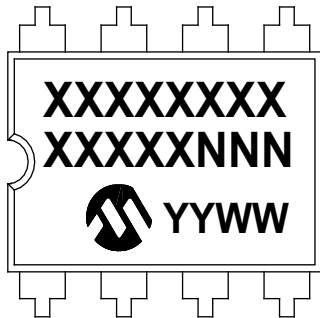

Example

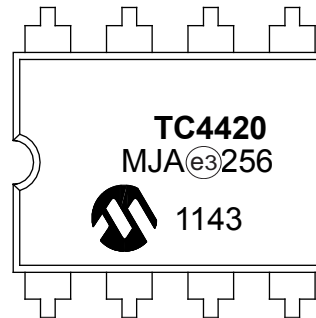

Legend: XX...X	Customer-specific information
Y	Year code (last digit of calendar year)
YY	Year code (last 2 digits of calendar year)
WW	Week code (week of January 1 is week '01')
NNN	Alphanumeric traceability code
^(e3)	Pb-free JEDEC designator for Matte Tin (Sn)
*	This package is Pb-free. The Pb-free JEDEC designator (^(e3)) can be found on the outer packaging for this package.

Note: In the event the full Microchip part number cannot be marked on one line, it will be carried over to the next line, thus limiting the number of available characters for customer-specific information.

8-Lead Ceramic Dual In-Line (JA) ~ .300" Body [CERDIP]

Note: For the most current package drawings, please see the Microchip Packaging Specification located at <http://www.microchip.com/packaging>

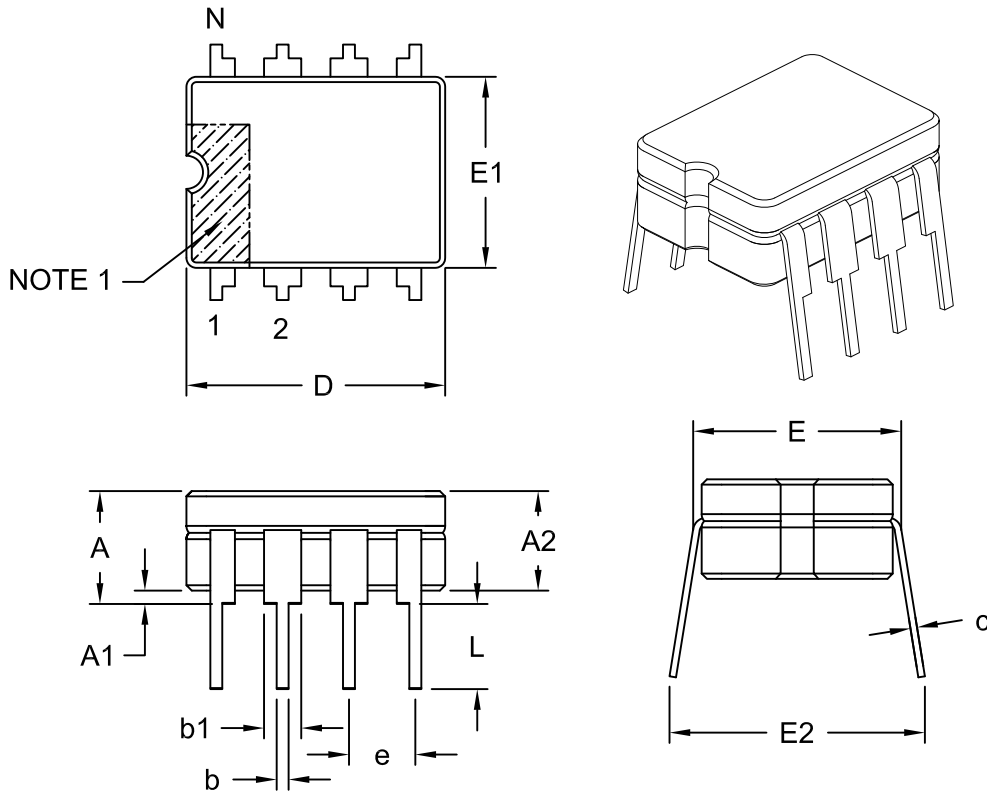

		Units	INCHES		
Dimension Limits			MIN	NOM	MAX
Number of Pins	N		8		
Pitch	e		.100 BSC		
Top to Seating Plane	A	-	-	-	.200
Base to Seating Plane §	A1	.015	-	-	-
Ceramic Package Height	A2	.140	-	-	.175
Shoulder to Shoulder Width	E	.290	-	-	.320
Ceramic Pkg. Width	E1	.230	.248	-	.300
Overall Length	D	.370	.380	-	.400
Tip to Seating Plane	L	.125	-	-	.200
Lead Thickness	c	.008	-	-	.015
Upper Lead Width	b1	.045	-	-	.065
Lower Lead Width	b	.015	-	-	.023
Overall Row Spacing	E2	.314	-	-	.410

Notes:

- Pin 1 visual index feature may vary, but must be located within the hatched area.
- § Significant Characteristic
- Dimensioning and tolerancing per ASME Y14.5M
BSC: Basic Dimension. Theoretically exact value shown without tolerances.

Microchip Technology Drawing No. C04-001C

TC4420M/TC4429M

NOTES:

APPENDIX A: REVISION HISTORY

Revision B (March 2012)

The following is the list of modifications:

1. Changed JEDEC indicator on the package marking and Legend in **Section 5.0 “Packaging Information”**.
2. Updated package specification drawing to the most recent Microchip standards.

Revision A (February 2005)

Original release of this document.

TC4420M/TC4429M

NOTES:

TC4420M/TC4429M

PRODUCT IDENTIFICATION SYSTEM

To order or obtain information, e.g., on pricing or delivery, refer to the factory or the listed sales office.

<u>PART NO.</u>	<u>X</u>	<u>XX</u>
Device	Temperature Range	Package
Device:	TC4420M: 6A High-Speed MOSFET Driver, Non-Inverting TC4429M: 6A High-Speed MOSFET Driver, Inverting	
Temperature Range:	M = -55°C to +125°C	
Package:	JA = Ceramic Dual In-line (300 mil Body), 8-lead	

Examples:

a) TC4420MJA: 6A High-Speed MOSFET Driver, Non-inverting, 8LD CERDIP package.

a) TC4429MJA: 6A High-Speed MOSFET Driver, Inverting, 8LD CERDIP package.

TC4420M/TC4429M

NOTES:

Note the following details of the code protection feature on Microchip devices:

- Microchip products meet the specification contained in their particular Microchip Data Sheet.
- Microchip believes that its family of products is one of the most secure families of its kind on the market today, when used in the intended manner and under normal conditions.
- There are dishonest and possibly illegal methods used to breach the code protection feature. All of these methods, to our knowledge, require using the Microchip products in a manner outside the operating specifications contained in Microchip's Data Sheets. Most likely, the person doing so is engaged in theft of intellectual property.
- Microchip is willing to work with the customer who is concerned about the integrity of their code.
- Neither Microchip nor any other semiconductor manufacturer can guarantee the security of their code. Code protection does not mean that we are guaranteeing the product as “unbreakable.”

Code protection is constantly evolving. We at Microchip are committed to continuously improving the code protection features of our products. Attempts to break Microchip's code protection feature may be a violation of the Digital Millennium Copyright Act. If such acts allow unauthorized access to your software or other copyrighted work, you may have a right to sue for relief under that Act.

Information contained in this publication regarding device applications and the like is provided only for your convenience and may be superseded by updates. It is your responsibility to ensure that your application meets with your specifications. MICROCHIP MAKES NO REPRESENTATIONS OR WARRANTIES OF ANY KIND WHETHER EXPRESS OR IMPLIED, WRITTEN OR ORAL, STATUTORY OR OTHERWISE, RELATED TO THE INFORMATION, INCLUDING BUT NOT LIMITED TO ITS CONDITION, QUALITY, PERFORMANCE, MERCHANTABILITY OR FITNESS FOR PURPOSE. Microchip disclaims all liability arising from this information and its use. Use of Microchip devices in life support and/or safety applications is entirely at the buyer's risk, and the buyer agrees to defend, indemnify and hold harmless Microchip from any and all damages, claims, suits, or expenses resulting from such use. No licenses are conveyed, implicitly or otherwise, under any Microchip intellectual property rights.

Trademarks

The Microchip name and logo, the Microchip logo, dsPIC, KEELOQ, KEELOQ logo, MPLAB, PIC, PICmicro, PICSTART, PIC³² logo, rPIC and UNI/O are registered trademarks of Microchip Technology Incorporated in the U.S.A. and other countries.

FilterLab, Hampshire, HI-TECH C, Linear Active Thermistor, MXDEV, MXLAB, SEEVAL and The Embedded Control Solutions Company are registered trademarks of Microchip Technology Incorporated in the U.S.A.

Analog-for-the-Digital Age, Application Maestro, chipKIT, chipKIT logo, CodeGuard, dsPICDEM, dsPICDEM.net, dsPICworks, dsSPEAK, ECAN, ECONOMONITOR, FanSense, HI-TIDE, In-Circuit Serial Programming, ICSP, Mindi, MiWi, MPASM, MPLAB Certified logo, MPLIB, MPLINK, mTouch, Omniscient Code Generation, PICC, PICC-18, PICDEM, PICDEM.net, PICKit, PICtail, REAL ICE, rLAB, Select Mode, Total Endurance, TSHARC, UniWinDriver, WiperLock and ZENA are trademarks of Microchip Technology Incorporated in the U.S.A. and other countries.

SQTP is a service mark of Microchip Technology Incorporated in the U.S.A.

All other trademarks mentioned herein are property of their respective companies.

© 2005-2012, Microchip Technology Incorporated, Printed in the U.S.A., All Rights Reserved.

 Printed on recycled paper.

ISBN: 978-1-62076-076-5

QUALITY MANAGEMENT SYSTEM
CERTIFIED BY DNV
== ISO/TS 16949 ==

Microchip received ISO/TS-16949:2009 certification for its worldwide headquarters, design and wafer fabrication facilities in Chandler and Tempe, Arizona; Gresham, Oregon and design centers in California and India. The Company's quality system processes and procedures are for its PIC[®] MCUs and dsPIC[®] DSCs, KEELOQ[®] code hopping devices, Serial EEPROMs, microperipherals, nonvolatile memory and analog products. In addition, Microchip's quality system for the design and manufacture of development systems is ISO 9001:2000 certified.



MICROCHIP

Worldwide Sales and Service

AMERICAS

Corporate Office
2355 West Chandler Blvd.
Chandler, AZ 85224-6199
Tel: 480-792-7200
Fax: 480-792-7277
Technical Support:
<http://www.microchip.com/support>
Web Address:
www.microchip.com

Atlanta
Duluth, GA
Tel: 678-957-9614
Fax: 678-957-1455

Boston
Westborough, MA
Tel: 774-760-0087
Fax: 774-760-0088

Chicago
Itasca, IL
Tel: 630-285-0071
Fax: 630-285-0075

Cleveland
Independence, OH
Tel: 216-447-0464
Fax: 216-447-0643

Dallas
Addison, TX
Tel: 972-818-7423
Fax: 972-818-2924

Detroit
Farmington Hills, MI
Tel: 248-538-2250
Fax: 248-538-2260

Indianapolis
Noblesville, IN
Tel: 317-773-8323
Fax: 317-773-5453

Los Angeles
Mission Viejo, CA
Tel: 949-462-9523
Fax: 949-462-9608

Santa Clara
Santa Clara, CA
Tel: 408-961-6444
Fax: 408-961-6445

Toronto
Mississauga, Ontario,
Canada
Tel: 905-673-0699
Fax: 905-673-6509

ASIA/PACIFIC

Asia Pacific Office
Suites 3707-14, 37th Floor
Tower 6, The Gateway
Harbour City, Kowloon
Hong Kong
Tel: 852-2401-1200
Fax: 852-2401-3431

Australia - Sydney
Tel: 61-2-9868-6733
Fax: 61-2-9868-6755

China - Beijing
Tel: 86-10-8569-7000
Fax: 86-10-8528-2104

China - Chengdu
Tel: 86-28-8665-5511
Fax: 86-28-8665-7889

China - Chongqing
Tel: 86-23-8980-9588
Fax: 86-23-8980-9500

China - Hangzhou
Tel: 86-571-2819-3187
Fax: 86-571-2819-3189

China - Hong Kong SAR
Tel: 852-2401-1200
Fax: 852-2401-3431

China - Nanjing
Tel: 86-25-8473-2460
Fax: 86-25-8473-2470

China - Qingdao
Tel: 86-532-8502-7355
Fax: 86-532-8502-7205

China - Shanghai
Tel: 86-21-5407-5533
Fax: 86-21-5407-5066

China - Shenyang
Tel: 86-24-2334-2829
Fax: 86-24-2334-2393

China - Shenzhen
Tel: 86-755-8203-2660
Fax: 86-755-8203-1760

China - Wuhan
Tel: 86-27-5980-5300
Fax: 86-27-5980-5118

China - Xian
Tel: 86-29-8833-7252
Fax: 86-29-8833-7256

China - Xiamen
Tel: 86-592-2388138
Fax: 86-592-2388130

China - Zhuhai
Tel: 86-756-3210040
Fax: 86-756-3210049

ASIA/PACIFIC

India - Bangalore
Tel: 91-80-3090-4444
Fax: 91-80-3090-4123

India - New Delhi
Tel: 91-11-4160-8631
Fax: 91-11-4160-8632

India - Pune
Tel: 91-20-2566-1512
Fax: 91-20-2566-1513

Japan - Osaka
Tel: 81-66-152-7160
Fax: 81-66-152-9310

Japan - Yokohama
Tel: 81-45-471-6166
Fax: 81-45-471-6122

Korea - Daegu
Tel: 82-53-744-4301
Fax: 82-53-744-4302

Korea - Seoul
Tel: 82-2-554-7200
Fax: 82-2-558-5932 or
82-2-558-5934

Malaysia - Kuala Lumpur
Tel: 60-3-6201-9857
Fax: 60-3-6201-9859

Malaysia - Penang
Tel: 60-4-227-8870
Fax: 60-4-227-4068

Philippines - Manila
Tel: 63-2-634-9065
Fax: 63-2-634-9069

Singapore
Tel: 65-6334-8870
Fax: 65-6334-8850

Taiwan - Hsin Chu
Tel: 886-3-5778-366
Fax: 886-3-5770-955

Taiwan - Kaohsiung
Tel: 886-7-536-4818
Fax: 886-7-330-9305

Taiwan - Taipei
Tel: 886-2-2500-6610
Fax: 886-2-2508-0102

Thailand - Bangkok
Tel: 66-2-694-1351
Fax: 66-2-694-1350

EUROPE

Austria - Wels
Tel: 43-7242-2244-39
Fax: 43-7242-2244-393

Denmark - Copenhagen
Tel: 45-4450-2828
Fax: 45-4485-2829

France - Paris
Tel: 33-1-69-53-63-20
Fax: 33-1-69-30-90-79

Germany - Munich
Tel: 49-89-627-144-0
Fax: 49-89-627-144-44

Italy - Milan
Tel: 39-0331-742611
Fax: 39-0331-466781

Netherlands - Drunen
Tel: 31-416-690399
Fax: 31-416-690340

Spain - Madrid
Tel: 34-91-708-08-90
Fax: 34-91-708-08-91

UK - Wokingham
Tel: 44-118-921-5869
Fax: 44-118-921-5820

11/29/11

Mouser Electronics

Authorized Distributor

Click to View Pricing, Inventory, Delivery & Lifecycle Information:

[Microchip:](#)

[TC4420MJA](#) [TC4429MJA](#)