

## R5050AC-2B

5.0×5.0mm, Super Bright Orange LED  
Surface Mount PLCC-6 LED Indicator



## Technical Data Sheet

---

### Features:

- PLCC-6 package.
- White package.
- High reliability package with silicone encapsulation.
- Ideal for backlight and light pipe application.
- Suitable for reflow and wave solder processes.
- The product itself will remain within RoHS compliant version

### Descriptions:

- The R5050 SMT LEDs is packaged in the industry standard PLCC-6 package. These SMT LEDs have high reliability performance and are designed to work under a wide range of environmental conditions. This high reliability feature makes them ideally suited to be used as interior signs application conditions.
- To facilitate easy pick & place assembly, the LEDs are packed in EIA-compliant tape and reel. Every reel will be shipped in single intensity and color bin.
- The wide viewing angle at 120° makes these LEDs ideally suited for panel, push button, industrial equipment, and home appliances. The flat top emitting surface makes it easy for these LEDs to mate with light pipes. With the built-in reflector pushing up the intensity of the light output, these LEDs are also suitable to be used as LED pixels in interior electronic signs.

### Applications:

- Non-automotive use.
- General Signage backlighting.
- Amusement machine backlighting.
- Industrial lighting.
- Light strips.

# R5050AC-2B

5.0×5.0mm, Super Bright Orange LED  
Surface Mount PLCC-6 LED Indicator



## Technical Data Sheet

Part No.	Emitting Color	Lens Color
R5050AC-2B	Super Bright Amber	Water Clear

### Package Dimension:

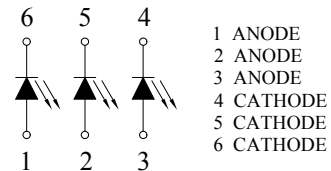
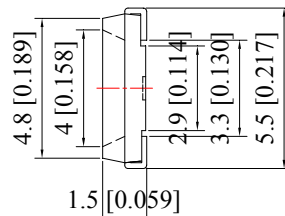
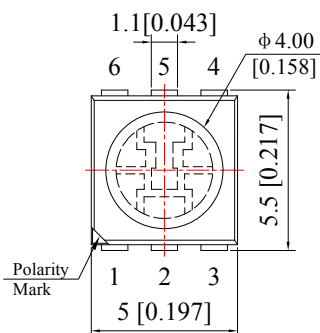

- 1 ANODE
- 2 ANODE
- 3 ANODE
- 4 CATHODE
- 5 CATHODE
- 6 CATHODE

### Polarity

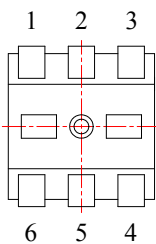
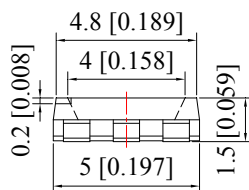

### Recommended Soldering Pad dimensions

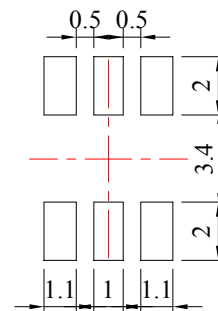

Unit: mm  
Tolerance: ±0.10mm

### Notes:

1. All dimensions are in millimeters (inches).
2. Tolerance is ± 0.25 mm (.010") unless otherwise noted.

## R5050AC-2B

5.0×5.0mm, Super Bright Orange LED  
Surface Mount PLCC-6 LED Indicator

LuckyLight

### Technical Data Sheet

#### Absolute Maximum Ratings at Ta=25°C

Parameters	Symbol	Max.	Unit
Power Dissipation	$P_d$	60×3	mW
Peak Forward Current <sup>(a)</sup>	$I_{FP}$	100×3	mA
DC Forward Current <sup>(b)</sup>	$I_F$	25×3	mA
Reverse Voltage	$V_R$	5	V
Operating Temperature Range	$T_{opr}$	-40°C to +80°C	
Storage Temperature Range	$T_{stg}$	-40°C to +85°C	
Soldering Temperature	$T_{slid}$	260°C for 5 Seconds	

Notes:

a. Derate linearly as shown in derating curve.

b. Duty Factor = 10%, Frequency = 1 kHz.

#### Electrical Optical Characteristics at Ta=25°C

Parameters	Symbol	Min.	Typ.	Max.	Unit	Test Condition
Luminous Intensity <sup>(a)</sup>	$I_V$	400	600	---	mcd	IF=20mA×3=60mA
Viewing Angle <sup>(b)</sup>	$2\theta_{1/2}$	---	120	---	Deg	IF=20mA×3=60mA
Peak Emission Wavelength	$\lambda_p$	---	610	---	nm	IF=20mA×3=60mA
Dominant Wavelength <sup>(c)</sup>	$\lambda_d$	---	605	---	nm	IF=20mA×3=60mA
Spectral Line Half-Width	$\Delta\lambda$	---	35	---	nm	IF=20mA×3=60mA
Forward Voltage	$V_F$	1.60	2.00	2.40	V	IF=20mA×3=60mA
Reverse Current	$I_R$	---	---	10	$\mu A$	VR=5V

Notes:

a. Luminous intensity is measured with a light sensor and filter combination that approximates the CIE eye-response curve.

b.  $2\theta_{1/2}$  is the o-axis angle where the luminous intensity is 1/2 the peak intensity.

c. The dominant wavelength ( $\lambda_d$ ) is derived from the CIE chromaticity diagram and represents the single wavelength which defines the color of the device.

# R5050AC-2B

5.0×5.0mm, Super Bright Orange LED  
Surface Mount PLCC-6 LED Indicator



## Technical Data Sheet

### Typical Electrical / Optical Characteristics Curves

(25°C Ambient Temperature Unless Otherwise Noted)

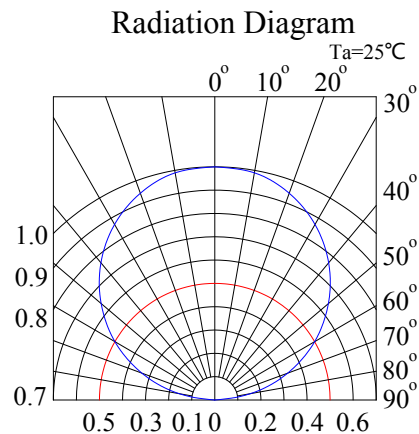
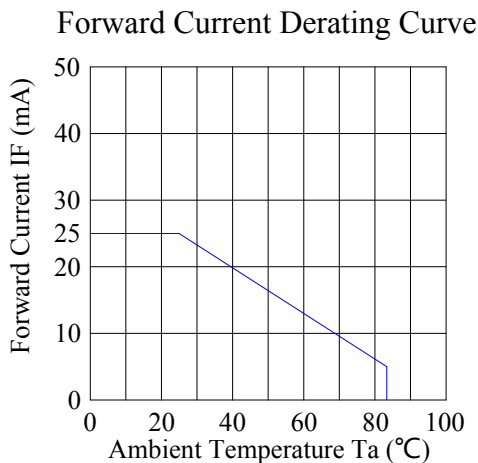
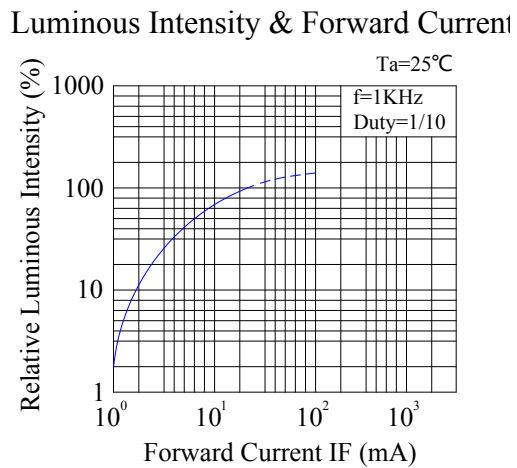
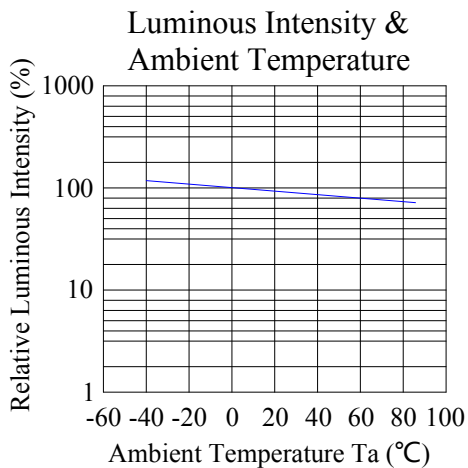
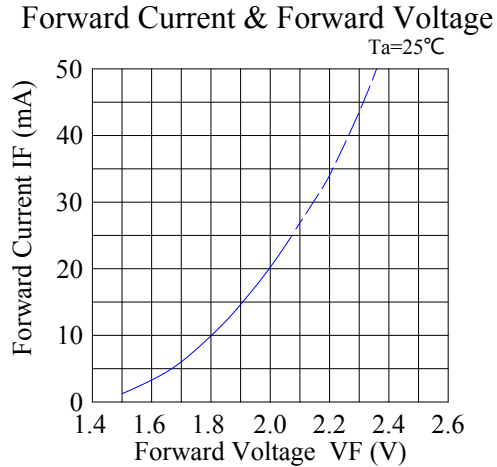
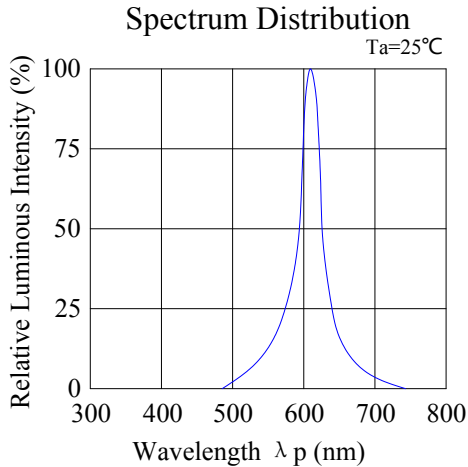

## R5050AC-2B

5.0×5.0mm, Super Bright Orange LED  
Surface Mount PLCC-6 LED Indicator

# LuckyLight

## Technical Data Sheet

### Reel Dimensions:

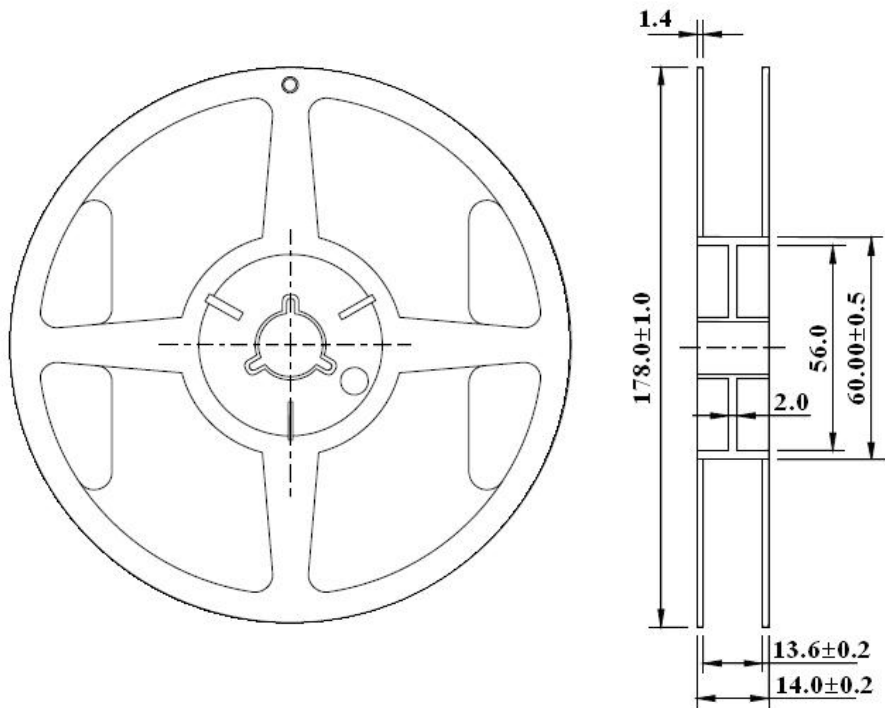

Unit: mm  
Tolerance: ±0.25mm

### Carrier Tape Dimensions:

Loaded quantity 1000PCS per reel.

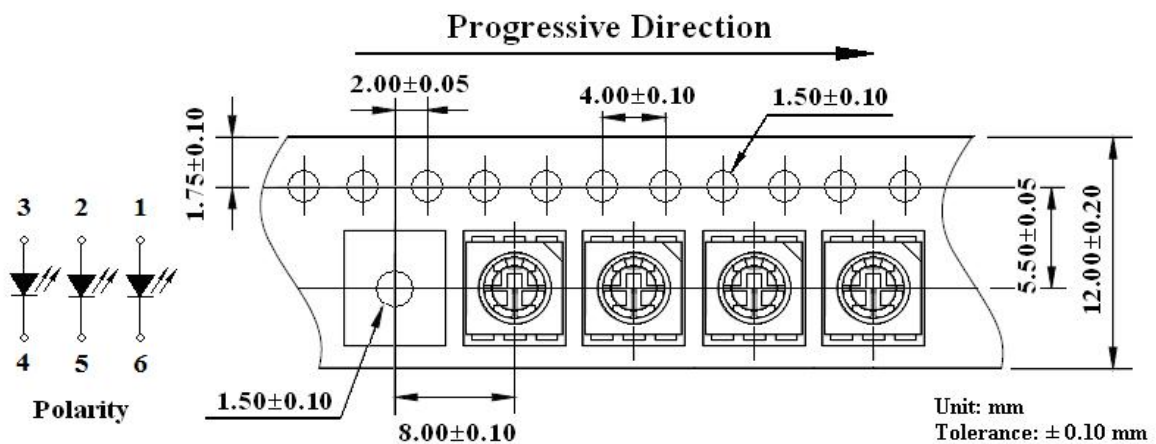

Unit: mm  
Tolerance: ±0.10 mm

# R5050AC-2B

5.0×5.0mm, Super Bright Orange LED  
Surface Mount PLCC-6 LED Indicator



## Technical Data Sheet

### Packing & Label Specifications:

Moisture Resistant Packaging:

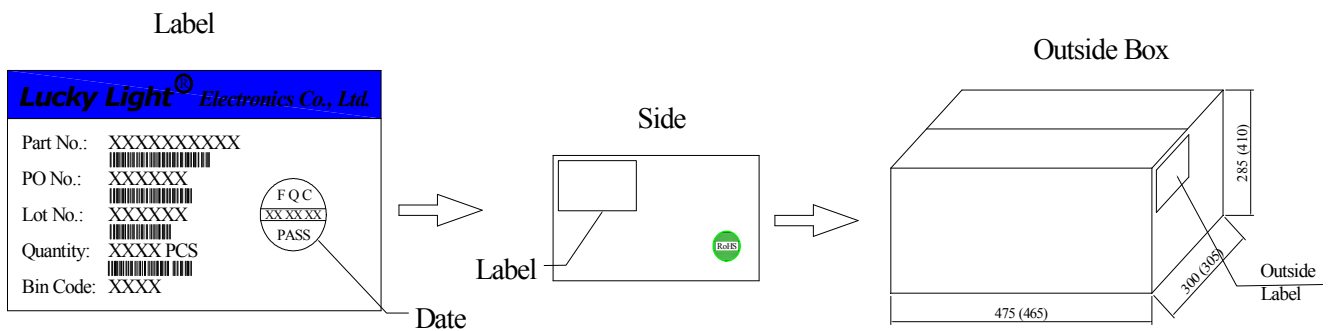
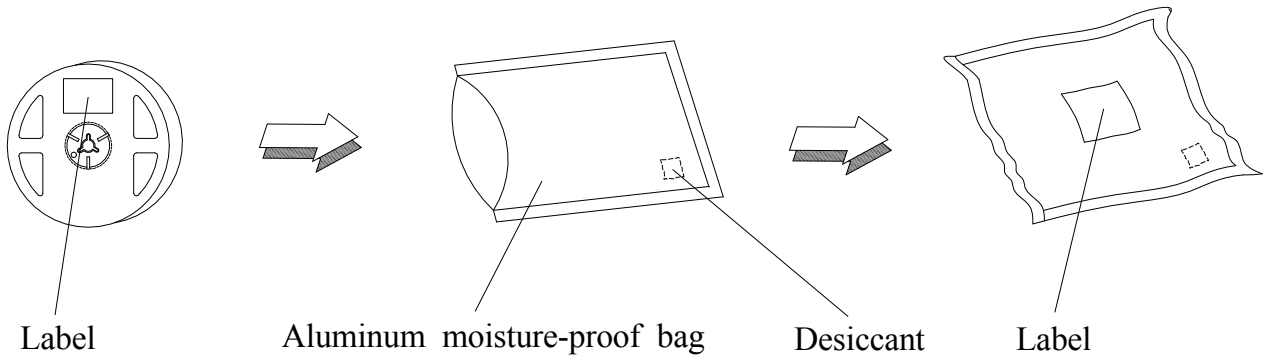

## R5050AC-2B

5.0×5.0mm, Super Bright Orange LED  
Surface Mount PLCC-6 LED Indicator

LuckyLight

## Technical Data Sheet

---

### CAUTIONS

#### 1. Handling Precautions:

- 1.1 Handle the component along the side surfaces by using forceps or appropriate tools.
- 1.2 Do not directly touch or handle the silicone lens surface. It may damage the internal circuitry.
- 1.3 Do not stack together assembled PCBs containing exposed LEDs. Impact may scratch the silicone lens or damage the internal circuitry.

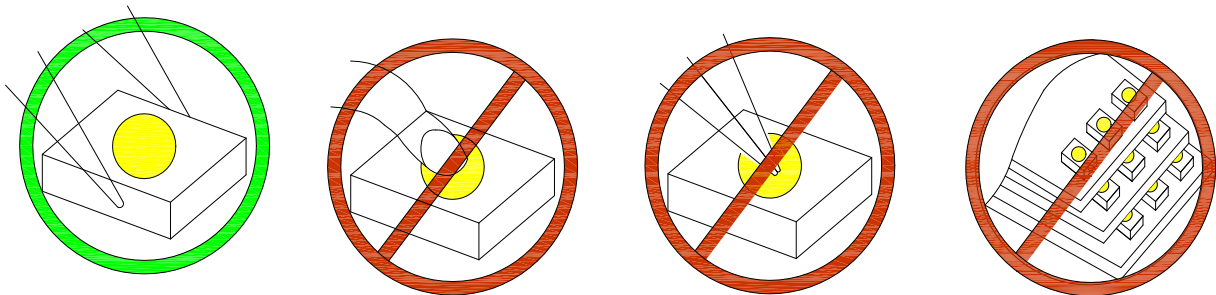

1.4 Compare to epoxy encapsulant that is hard and brittle, silicone is softer and flexible. Although its characteristic significantly reduces thermal stress, it is more susceptible to damage by external mechanical force. As a result, special handling precautions need to be observed during assembly using silicone encapsulated LED products. Failure to comply might lead to damage and premature failure of the LED.

#### 2. Storage:

- 2.1 Do not open moisture proof bag before the products are ready to use.
- 2.2 Before opening the package, the LEDs should be kept at 30°C or less and 60%RH or less.
- 2.3 The LEDs should be used within a year.
- 2.4 After opening the package, the LEDs should be kept at 30°C or less and 60%RH or less.
- 2.5 The LEDs should be used within 24 hours after opening the package.
- 2.6 If the moisture adsorbent material has faded away or the LEDs have exceeded the storage time, baking treatment should be performed using the following conditions. Baking treatment: 65±5°C for 24 hours.

# R5050AC-2B

5.0×5.0mm, Super Bright Orange LED  
Surface Mount PLCC-6 LED Indicator



## Technical Data Sheet

### 3. Soldering Condition:

3.1 Pb-free solder temperature profile.

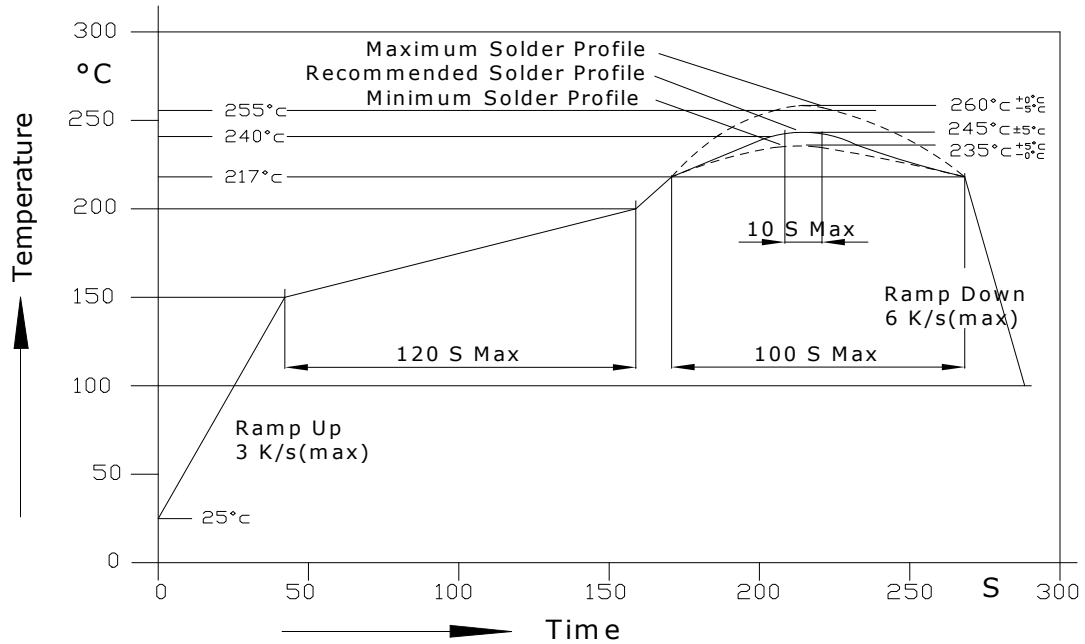

3.2 Reflow soldering should not be done more than two times.

3.3 When soldering, do not put stress on the LEDs during heating.

3.4 After soldering, do not warp the circuit board.

3.5 Recommended soldering conditions:

Reflow soldering		Soldering iron	
Pre-heat	150~200°C	Temperature	300°C Max.
Pre-heat time	120 sec. Max.	Soldering time	3 sec. Max.
Peak temperature	260°C Max.		(one time only)
Soldering time	10 sec. Max. (Max. two times)		

3.6 Because different board designs use different number and types of devices, solder pastes, reflow ovens, and circuit boards, no single temperature profile works for all possible combinations.

However, you can successfully mount your packages to the PCB by following the proper guidelines and PCB-specific characterization.



## R5050AC-2B

5.0×5.0mm, Super Bright Orange LED  
Surface Mount PLCC-6 LED Indicator

LuckyLight

## Technical Data Sheet

---

### 4. Drive Method:

4.1 An LED is a current-operated device. In order to ensure intensity uniformity on multiple LEDs connected in parallel in an application, it is recommended that a current limiting resistor be incorporated in the drive circuit, in series with each LED as shown in Circuit A below.

Circuit model A

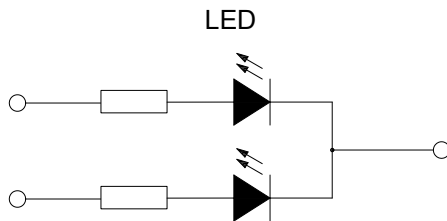

Circuit model B

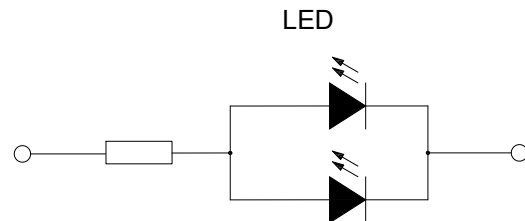

(A) Recommended circuit.

(B) The brightness of each LED might appear different due to the differences in the I-V characteristics of those LEDs.

### Terms and conditions for the usage of this document:

1. The information included in this document reflects representative usage scenarios and is intended for technical reference only.
2. The part number, type, and specifications mentioned in this document are subject to future change and improvement without notice. Before production usage customer should refer to the latest datasheet for the updated specifications.
3. When using the products referenced in this document, please make sure the product is being operated within the environmental and electrical limits specified in the datasheet. If customer usage exceeds the specified limits, LuckyLight will not be responsible for any subsequent issues.
4. The information in this document applies to typical usage in consumer electronics applications. If customer's application has special reliability requirements or have life-threatening liabilities, such as automotive or medical usage, please consult with LuckyLight representative for further assistance.
5. The contents and information of this document may not be reproduced or re-transmitted without permission by LuckyLight.