

LSA+ Type IDC Contacts

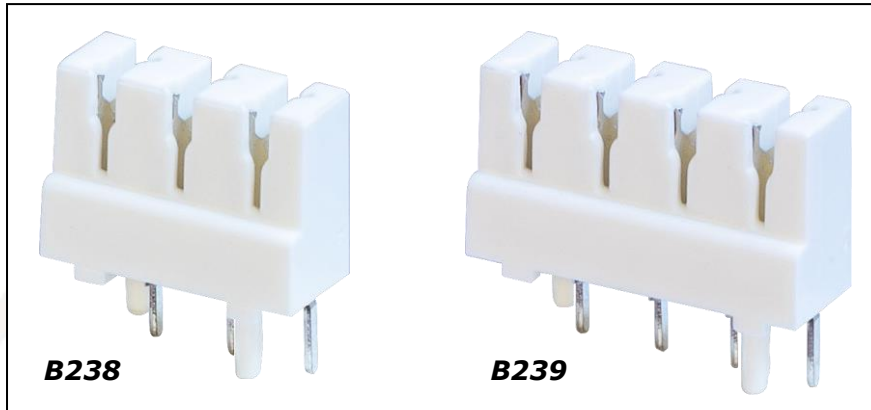

LSA+ Type IDC Contacts, 5.08mm pitch, 3 Way and 4 Way (B238, B239)
3 way and 4 way PCB mount IDC contacts for LSA+ connections.

Features:

- Termination using LSA+ type punch down tool. No need for soldering or screw terminations
- Includes PCB mount retaining posts for heat staking, ensuring a secure fit
- Pitch of 5.08mm between contacts
- Voltage rating of 60V AC RMS
- Operating temperatures from -20° to 125°
- Suitable for wave soldering
- Known by BT codes 238A and 239A

Specifications:

- Net weight (including primary packaging):
 - B238: 1.65 g B239: 2.83g
 - B238#20: 34.5g B239#20: 42.3g
 - B238#50: 82.50 B239#50: 141.50
 - B238#100: 165.6g B239#100: 212.3g
- Dimensions:
 - B238 (3 way): 16.72 x 21.8 x 7.2 mm
 - B239 (4 way): 16.9 x 21.8 x 7.2 mm
- Colour: white
- Materials:
 - Housing: PC UL94V-0
 - Contacts: Phosphor bronze with tin plating

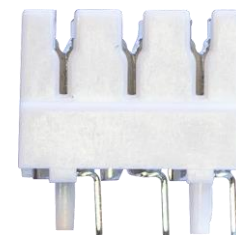

B238

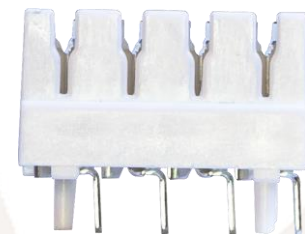

B239

Packaging: packaged in poly bags of 50, or cartons of 1000

Commodity code: 85366930

EAN: B238: 5055386510075
B238#20: 5055386510334
B238#50: 5055386510105
B238#100: 5055386510341

B239: 5055386510082
B239#20: 5055386510358
B239#50: 5055386510112
B239#100: 5055386510365

Country of Origin: China

14/11/2022

ROHS Compliant

Code: B238, B239

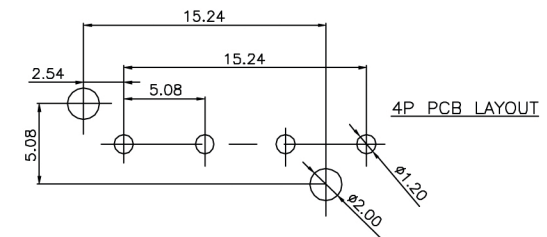
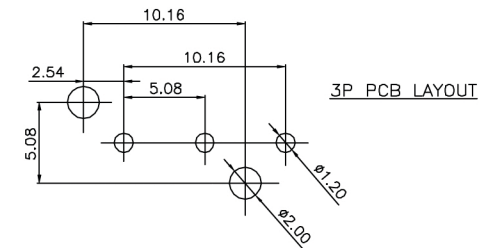
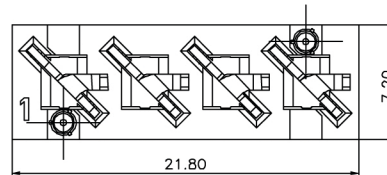
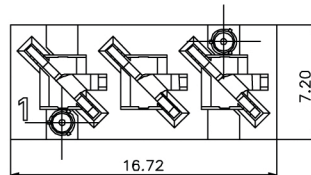
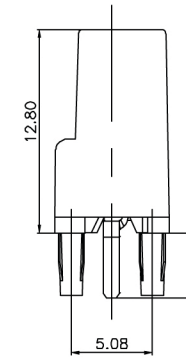
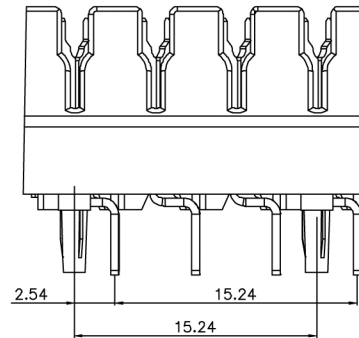
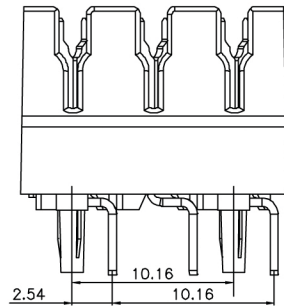

NOTES:

1. HOUSING: PC UL94V-0
2. CONTACT: PHOSPHOR BRONZE WITH SILVER PLATING
3. WIRE: CABLE SIZE:
SOLID COPPER WIRES UP TO 0.4 mm - 0.8 mm IN DIA.
INSULATION:
PE OR PVC INSULATED WIRE (100% PE/FOAM SKIN, FILLED/UNFILLED)
UP TO 1.4 mm IN DIAMETER
4. CONTACT RESISTANCE: 10 MILLIOHMS MAX.
5. VOLTAGE RATING: 250 VDC
6. OPERATING TEMPERATURE: -20°C TO +125°C AND HUMIDITY UP TO 95%
7. INSULATION RESISTANCE: 500 VDC, VOLTAGE APPLIED 5000 MEGOHMS MIN.
8. DIELECTRIC STRENGTH: AC 2000 VRMS