

奇数キャビティ：キャビティ番号及び金型番号
 偶数キャビティ：トレードマーク
 ODD CAVITY: CAVITY AND MOLD NO.
 EVEN CAVITY: TRADE MARK

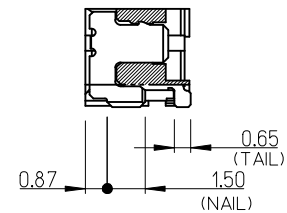
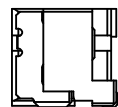

SECTION A-A

奇数キャビティ：トレードマーク
 偶数キャビティ：キャビティ番号及び金型番号
 ODD CAVITY: TRADE MARK
 EVEN CAVITY: CAVITY AND MOLD NO.

NOTES

- 嵌合相手: 505565**0*
MATE WITH: 505565**0*
- 偶数極に適用
APPLY FOR EVEN CKT.
- 製品仕様書: 5055650000
PRODUCT SPECIFICATION: 5055650000
- オーダー番号と色、極数の関係
RELATION ORDER NUMBER AND COLOR, CKT.

505567**7*	NO.	COLOR
極数	色	
CIRCUIT NO.	COLOR	
	0	NATURAL
	1	BLACK
	2	RED
	3	YELLOW
	4	BLUE
	6	GREEN
	8	ORANGE

- ELV及びRoHS適合品
ELV AND RoHS COMPLIANT
- ターミナルとネイルの平坦度は0.1mm以下
TERMINAL AND NAIL COPLANARITY : 0.1mm MAX.

10.70	18.75	22.20	23.25	505567167*	16
10.70	17.50	20.95	22.00	505567157*	15
10.70	16.25	19.70	20.75	505567147*	14
9.20	15.00	18.45	19.50	505567137*	13
9.20	13.75	17.20	18.25	505567127*	12
9.20	12.50	15.95	17.00	505567117*	11
9.20	11.25	14.70	15.75	505567107*	10
6.70	10.00	13.45	14.50	505567097*	9
6.70	8.75	12.20	13.25	505567087*	8
6.70	7.50	10.95	12.00	505567077*	7
6.60	6.25	9.70	10.75	505567067*	6
5.35	5.00	8.45	9.50	505567057*	5
4.10	3.75	7.20	8.25	505567047*	4
2.85	2.50	5.95	7.00	505567037*	3
1.90	1.25	4.70	5.75	505567027*	2
D	C	B	A	EMBOSSED TAPE PKG	極数
				ORDER NO.	CKT NO.

部品	材質
PART	MATERIAL
ハウジング	ポリアミド(PA)、ガラス充填、UL94 V-0、色:SHEET 2参照
HOUSING	POLYAMIDE (PA), GLASS FILLED, UL94 V-0, COLOR: SEE SHEET 2
ターミナル	黄銅
TERMINAL	BRASS
	錫ビスマスめっき: 1.0 MICRO-METER MIN.
	TIN-BISMUTH PLATED
	ニッケルめっき(下地): 1.0 MICRO-METER MIN.
	NICKEL (UNDER-PLATED)
ネイル	黄銅
NAIL	BRASS
	錫めっき: 1.0 MICRO-METER MIN.
	MATTE TIN PLATED
	ニッケルめっき(下地): 1.0 MICRO-METER MIN.
	NICKEL (UNDER-PLATED)

REVISED EC NO: J2017-0318 DRAWN: TAKAIKE 2016/12/14 CHKD: KOMURAKAMI 2016/12/15 APPR: TKANEKO 2016/12/15	GENERAL TOLERANCES (UNLESS SPECIFIED)	DIMENSION STYLE MM ONLY	SCALE 5:1	DESIGN UNITS METRIC	THIRD ANGLE PROJECTION
	0.25 UNDER ±0.03	DRAWN BY TAKAIKE	DATE 2016/03/29	TITLE MICRO-LOCK PLUS 1.25 W/B SINGLE ROW RA SMT PLUG ASSY	
	0.25 OVER 0.5 UNDER ±0.05	CHECKED BY KASAKAWA	DATE 2016/03/31	molex	
	0.5 OVER 1.0 UNDER ±0.1	APPROVED BY TKANEKO	DATE 2016/10/21		
	1.0 OVER 10 UNDER ±0.2	MATERIAL NO. SEE SHEET 2		DOCUMENT NO. SD-505567-001	SHEET NO. 1 OF 2
10 OVER 30 UNDER ±0.25	THIS DRAWING CONTAINS INFORMATION THAT IS PROPRIETARY TO MOLEX ELECTRONIC TECHNOLOGIES, LLC AND SHOULD NOT BE USED WITHOUT WRITTEN PERMISSION				
30 OVER ±0.3	DRAFT WHERE APPLICABLE MUST REMAIN WITHIN DIMENSIONS				

10 9 8 7 6 5 4 3 2 1

F

E

D

C

B

A

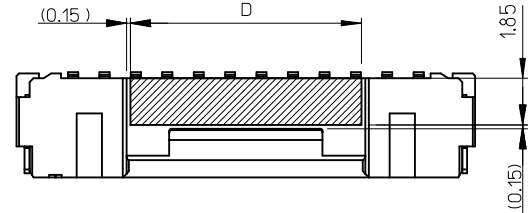
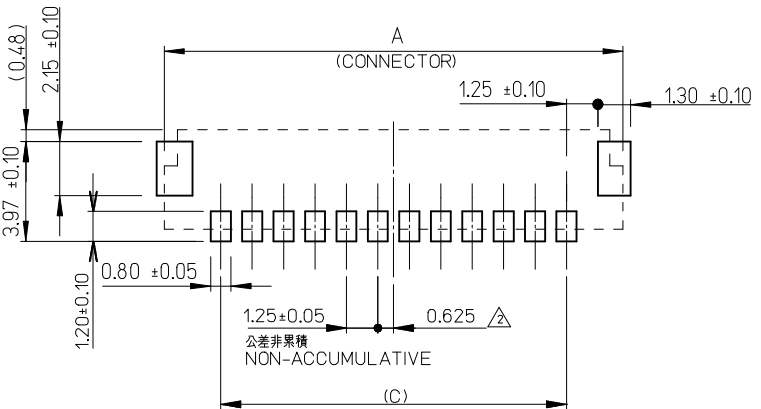

推奨基板レイアウト
RECOMMENDED PCB PATTERN LAYOUT

(参考:メタルマスク厚さ 150μm, マスク開口率 100%)
(REFERENCE: METAL MASK THICKNESS 150μM, APERTURE RASIO 100%)

ORANGE	GREEN	BLUE	YELLOW	RED	BLACK	NATURAL (BEIGE)	HOUSING COLOR
5055671678	5055671676	5055671674	5055671673	5055671672	5055671671	5055671670	16
5055671578	5055671576	5055671574	5055671573	5055671572	5055671571	5055671570	15
5055671478	5055671476	5055671474	5055671473	5055671472	5055671471	5055671470	14
5055671378	5055671376	5055671374	5055671373	5055671372	5055671371	5055671370	13
5055671278	5055671276	5055671274	5055671273	5055671272	5055671271	5055671270	12
5055671178	5055671176	5055671174	5055671173	5055671172	5055671171	5055671170	11
5055671078	5055671076	5055671074	5055671073	5055671072	5055671071	5055671070	10
5055670978	5055670976	5055670974	5055670973	5055670972	5055670971	5055670970	9
5055670878	5055670876	5055670874	5055670873	5055670872	5055670871	5055670870	8
5055670778	5055670776	5055670774	5055670773	5055670772	5055670771	5055670770	7
5055670678	5055670676	5055670674	5055670673	5055670672	5055670671	5055670670	6
5055670578	5055670576	5055670574	5055670573	5055670572	5055670571	5055670570	5
5055670478	5055670476	5055670474	5055670473	5055670472	5055670471	5055670470	4
5055670378	5055670376	5055670374	5055670373	5055670372	5055670371	5055670370	3
5055670278	5055670276	5055670274	5055670273	5055670272	5055670271	5055670270	2
EMBOSSED TAPE PKG	EMBOSSED TAPE PKG	EMBOSSED TAPE PKG	EMBOSSED TAPE PKG	EMBOSSED TAPE PKG	EMBOSSED TAPE PKG	EMBOSSED TAPE PKG	極数
ORDER NO.	ORDER NO.	ORDER NO.	ORDER NO.	ORDER NO.	ORDER NO.	ORDER NO.	CKT NO.

SEE SHEET 1 EC NO: J2017-0318 DRWN: TAKAIKE 2016/12/14 CHKD: KOMURAKAMI 2016/12/15 APPR: TKANEKO 2016/12/15	GENERAL TOLERANCES (UNLESS SPECIFIED)		DIMENSION STYLE MM ONLY		SCALE ---	DESIGN UNITS METRIC	THIRD ANGLE PROJECTION
	0.25 UNDER	± 0.03	DRAWN BY	DATE	TITLE		
	0.25 OVER 0.5 UNDER	± 0.05	TAKAIKE	2016/03/29	MICRO-LOCK PLUS 1.25 W/B SINGLE ROW RA SMT PLUG ASSY		
	0.5 OVER 1.0 UNDER	± 0.1	CHECKED BY	DATE			
	1.0 OVER 30 UNDER	± 0.2	KASAKAWA	2016/03/31			
10 OVER 30 UNDER	± 0.25	APPROVED BY	DATE				
30 OVER	± 0.3	TKANEKO	2016/10/21	MATERIAL NO.	DOCUMENT NO.	SHEET NO.	
ANGULAR ±1 °		SEE TABLE		SD-505567-001		2 OF 2	
DRAFT WHERE APPLICABLE MUST REMAIN WITHIN DIMENSIONS		SIZE A3	THIS DRAWING CONTAINS INFORMATION THAT IS PROPRIETARY TO MOLEX ELECTRONIC TECHNOLOGIES, LLC AND SHOULD NOT BE USED WITHOUT WRITTEN PERMISSION				

9 8 7 6 5 4 3 2 1

10 9 8 7 6 5 4 3 2 1

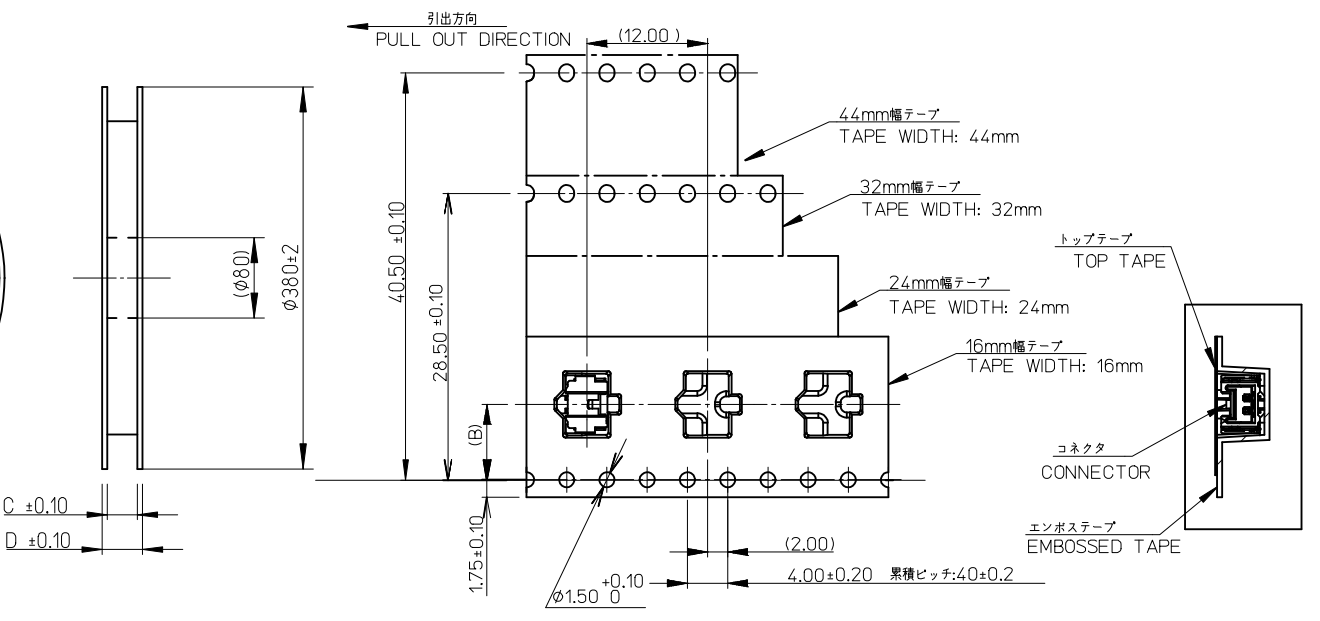
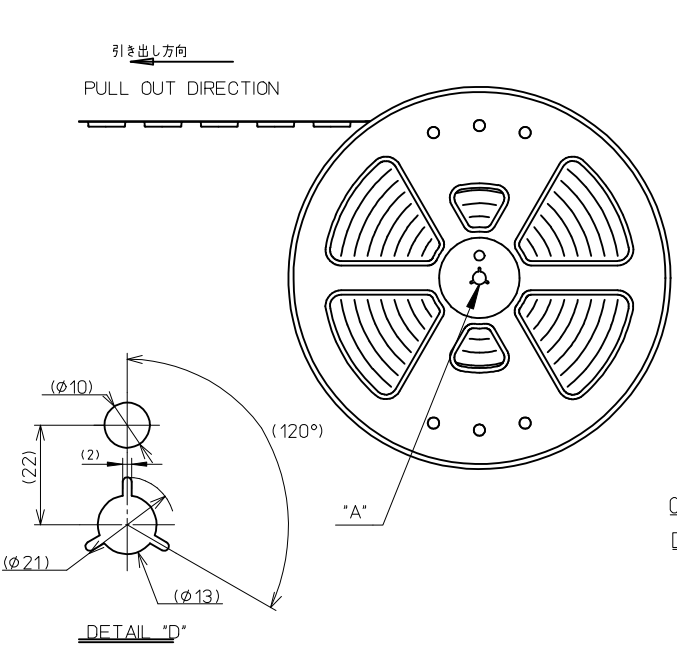

- NOTES**
- 製品詳細寸法については、製品単体図面を参照下さい。
THE DETAIL DIMENSION REFER TO SALES DRAWING OF CONNECTOR ITSELF (NOT PACKAGED).
 - 梱包数量: 1200個/リール
NUMBER OF CONNECTORS: 1200 PCS/REEL.
 - リードテープ長さ LEAD TAPE LENGTH.

引き出し方向 トップテープ接着部(空エンボス)
PULL OUT DIRECTION TOP TAPE BONDED PART.(EMPTY)

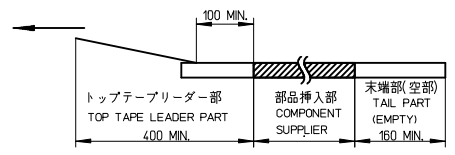

4. トップテープの剥離強度はIEC60286-3に準拠
TOP TAPE PEELING FORCE IS DEFINED BY IEC60286-3.

5. 材料 MATERIAL
キャリアテープ (CARRIER TAPE): ポリスチレン (POLYSTYRENE)
トップテープ(TOP TAPE) PET
リール (REEL): ポリスチレン <リサイクル材含む> (PS)
POLYSTYRENE (PS)<RECYCLE MATERIAL CONTAINED>

6. ELV 及びRoHS適合品
ELV AND RoHS COMPLIANT

49.4	45.4	20.2	44	505567167*	16
49.4	45.4	20.2	44	505567157*	15
49.4	45.4	20.2	44	505567147*	14
37.4	33.4	14.2	32	505567137*	13
37.4	33.4	14.2	32	505567127*	12
37.4	33.4	14.2	32	505567117*	11
37.4	33.4	14.2	32	505567107*	10
29.4	25.4	11.5	24	505567097*	9
29.4	25.4	11.5	24	505567087*	8
29.4	25.4	11.5	24	505567077*	7
29.4	25.4	11.5	24	505567067*	6
29.4	25.4	11.5	24	505567057*	5
29.4	25.4	11.5	24	505567047*	4
21.4	17.4	7.5	16	505567037*	3
21.4	17.4	7.5	16	505567027*	2
D	C	B	エンボステープ幅 WIDTH OF TAPE A	エンボス梱包 EMBOSSED TAPE PACKAGE オーダー番号 ORDER NO.	極数 CKT NO.

RELEASED EC NO: J2017-0222 DRW:SSAT002 2016/07/07 CHKD:KOMURAKAMI 2016/10/13 APPR:TKANEKO 2016/10/21	DESCRIPTION GENERAL TOLERANCES (UNLESS SPECIFIED) DIMENSION STYLE MM ONLY SCALE --- DESIGN UNITS METRIC THIRD ANGLE PROJECTION	0.25 UNDER ±0.03	DRAWN BY SSAT002	DATE 2016/07/07	TITLE MICRO-LOCK PLUS 1.25 W/B SINGLE ROW RA SMT EMBOSSED TAPE PKG molex DOCUMENT NO. SD-505567-002 SHEET NO. 1 OF 2
		0.25 OVER 0.5 UNDER ±0.05	CHECKED BY KASAKAWA	DATE 2016/07/07	
		0.5 OVER 1.0 UNDER ±0.1	APPROVED BY TKANEKO	DATE 2016/10/21	
		1.0 OVER 10 UNDER ±0.2	MATERIAL NO.		
		10 OVER 30 UNDER ±0.25	SEE SHEET 2		
30 OVER ±0.3	DRAFT WHERE APPLICABLE MUST REMAIN WITHIN DIMENSIONS		SIZE A3	THIS DRAWING CONTAINS INFORMATION THAT IS PROPRIETARY TO MOLEX ELECTRONIC TECHNOLOGIES, LLC AND SHOULD NOT BE USED WITHOUT WRITTEN PERMISSION	

9 8 7 6 5 4 3 2 1

ORANGE	GREEN	BLUE	YELLOW	RED	BLACK	NATURAL (BEIGE)	HSG COLOR
5055671678	5055671676	5055671674	5055671673	5055671672	5055671671	5055671670	16
5055671578	5055671576	5055671574	5055671573	5055671572	5055671571	5055671570	15
5055671478	5055671476	5055671474	5055671473	5055671472	5055671471	5055671470	14
5055671378	5055671376	5055671374	5055671373	5055671372	5055671371	5055671370	13
5055671278	5055671276	5055671274	5055671273	5055671272	5055671271	5055671270	12
5055671178	5055671176	5055671174	5055671173	5055671172	5055671171	5055671170	11
5055671078	5055671076	5055671074	5055671073	5055671072	5055671071	5055671070	10
5055670978	5055670976	5055670974	5055670973	5055670972	5055670971	5055670970	9
5055670878	5055670876	5055670874	5055670873	5055670872	5055670871	5055670870	8
5055670778	5055670776	5055670774	5055670773	5055670772	5055670771	5055670770	7
5055670678	5055670676	5055670674	5055670673	5055670672	5055670671	5055670670	6
5055670578	5055670576	5055670574	5055670573	5055670572	5055670571	5055670570	5
5055670478	5055670476	5055670474	5055670473	5055670472	5055670471	5055670470	4
5055670378	5055670376	5055670374	5055670373	5055670372	5055670371	5055670370	3
5055670278	5055670276	5055670274	5055670273	5055670272	5055670271	5055670270	2
EMBOSSED TAPE PKG	EMBOSSED TAPE PKG	EMBOSSED TAPE PKG	EMBOSSED TAPE PKG	EMBOSSED TAPE PKG	EMBOSSED TAPE PKG	EMBOSSED TAPE PKG	極数 CKT NO.
ORDER NO.	ORDER NO.	ORDER NO.	ORDER NO.	ORDER NO.	ORDER NO.	ORDER NO.	ORDER NO.

SEE SHEET 1 EC NO: J2017-0222 DRWN:SSAT002 2016/07/07 CHKD:KOMURAKAMI 2016/10/13 APPR:TKANEKO 2016/10/21	GENERAL TOLERANCES (UNLESS SPECIFIED)		DIMENSION STYLE MM ONLY		SCALE ---	DESIGN UNITS METRIC	THIRD ANGLE PROJECTION
	0.25 UNDER	± 0.03	DRAWN BY	DATE	TITLE		
	0.25 OVER 0.5 UNDER	± 0.05	SSAT002	2016/07/07	MICRO-LOCK PLUS 1.25 W/B SINGLE ROW RA SMT EMBOSSED TAPE PKG		
	0.5 OVER 1.0 UNDER	± 0.1	CHECKED BY	DATE			
	1.0 OVER 10 UNDER	± 0.2	KASAKAWA	2016/07/07	<div style="text-align: center; font-size: 2em; font-weight: bold;">molex</div>		
10 OVER 30 UNDER	± 0.25	APPROVED BY	DATE				
30 OVER	± 0.3	TKANEKO	2016/10/21	MATERIAL NO.	DOCUMENT NO.	SHEET NO.	
ANGULAR ±1 °		SEE TABLE		SD-505567-002		2 OF 2	
DRAFT WHERE APPLICABLE MUST REMAIN WITHIN DIMENSIONS			SIZE A3	THIS DRAWING CONTAINS INFORMATION THAT IS PROPRIETARY TO MOLEX ELECTRONIC TECHNOLOGIES, LLC AND SHOULD NOT BE USED WITHOUT WRITTEN PERMISSION			