

PCV 6-16/ 3-G1-10,16 - PCB header



1998797

<https://www.phoenixcontact.com/us/products/1998797>

Please be informed that the data shown in this PDF document is generated from our online catalog. Please find the complete data in the user documentation. Our general terms of use for downloads are valid.



PCB headers, nominal cross section: 16 mm², color: green, nominal current: 76 A (41 A in combination with PC 6 plug), rated voltage (III/2): 1000 V, contact surface: Silver, contact connection type: Pin, number of potentials: 3, number of rows: 1, number of positions: 3, number of connections: 3, product range: PCV 6-16/..-G1, pitch: 10.16 mm, mounting: Wave soldering, pin layout: Linear pinning, solder pin [P]: 4 mm, number of solder pins per potential: 3, plug-in system: COMBICON PC 16, Pin connector pattern alignment: Standard, locking: without, mounting: without, type of packaging: packed in cardboard

Your advantages

- Well-known mounting principle allows worldwide use
- Maximum flexibility when it comes to device design – one header for connectors with different connection technologies

Commercial data

Item number	1998797
Packing unit	1 pc
Minimum order quantity	50 pc
Sales key	AA05
Product key	AAESBE
Catalog page	Page 568 (C-1-2013)
GTIN	4046356038294
Weight per piece (including packing)	13.352 g
Weight per piece (excluding packing)	12.793 g
Customs tariff number	85366930
Country of origin	PL

PCV 6-16/ 3-G1-10,16 - PCB header



1998797

<https://www.phoenixcontact.com/us/products/1998797>

Technical data

Product properties

Type	Standard
Product line	COMBICON Connectors XL
Product type	PCB headers
Product family	PCV 6-16/..-G1
Number of positions	3
Pitch	10.16 mm
Number of connections	3
Number of rows	1
Mounting flange	without
Number of potentials	3
Pin layout	Linear pinning
Solder pins per potential	3

Electrical properties

Nominal current I_N	76 A (41 A in combination with PC 6 plug)
Nominal voltage U_N	1000 V
Degree of pollution	3
Contact resistance	0.5 m Ω
Rated voltage (III/3)	1000 V
Rated surge voltage (III/3)	8 kV
Rated voltage (III/2)	1000 V
Rated surge voltage (III/2)	8 kV
Rated voltage (II/2)	1000 V
Rated surge voltage (II/2)	6 kV

Mounting

Mounting type	Wave soldering
Pin layout	Linear pinning

Material specifications

Material data - contact

Note	WEEE/RoHS-compliant, free of whiskers according to IEC 60068-2-82/JEDEC JESD 201
Contact material	Cu alloy
Surface characteristics	Electroplated silver
Metal surface contact area (top layer)	Silver (4 - 8 μm Ag)
Metal surface contact area (middle layer)	Nickel (2 - 4 μm Ni)
Metal surface soldering area (top layer)	Silver (4 - 8 μm Ag)
Metal surface soldering area (middle layer)	Nickel (2 - 4 μm Ni)

Material data - housing

PCV 6-16/ 3-G1-10,16 - PCB header



1998797

<https://www.phoenixcontact.com/us/products/1998797>

Color (Housing)	green (6021)
Insulating material	PA
Insulating material group	I
CTI according to IEC 60112	600
Flammability rating according to UL 94	V0
Glow wire flammability index GWFI according to EN 60695-2-12	850
Glow wire ignition temperature GWIT according to EN 60695-2-13	775
Temperature for the ball pressure test according to EN 60695-10-2	125 °C

Notes

General	In accordance with IEC 61984, COMBICON connectors have no switching power (COC). During designated use, they must not be plugged in or disconnected when carrying voltage or under load.
---------	--

Dimensions

Dimensional drawing	
Pitch	10.16 mm
Width [w]	33.52 mm
Height [h]	38 mm
Length [l]	13.4 mm
Installed height	34 mm
Solder pin length [P]	4 mm
Pin dimensions	1 x 1.2 mm

PCB design

Pin spacing	1.16 mm
Hole diameter	1.7 mm

Mechanical tests

Visual inspection

Specification	IEC 60512-1-1:2002-02
Result	Test passed

Dimension check

Specification	IEC 60512-1-2:2002-02
Result	Test passed

Resistance of inscriptions

Specification	IEC 60068-2-70:1995-12
Result	Test passed

PCV 6-16/ 3-G1-10,16 - PCB header



1998797

<https://www.phoenixcontact.com/us/products/1998797>

Polarization and coding

Specification	IEC 60512-13-5:2006-02
Result	Test passed

Contact holder in insert

Specification	IEC 60512-15-1:2008-05
Contact holder in insert Requirements >20 N	Test passed

Insertion and withdrawal forces

Result	Test passed
No. of cycles	25
Insertion strength per pos. approx.	8 N
Withdraw strength per pos. approx.	6 N

Electrical tests

Thermal test | Test group C

Specification	IEC 60512-5-1:2002-02
Tested number of positions	9

Insulation resistance

Specification	IEC 60512-3-1:2002-02
Insulation resistance, neighboring positions	> 5 MΩ

Air clearances and creepage distances |

Specification	IEC 60664-1:2007-04
Insulating material group	I
Comparative tracking index (IEC 60112)	CTI 600
Rated insulation voltage (III/3)	1000 V
Rated surge voltage (III/3)	8 kV
minimum clearance value - non-homogenous field (III/3)	8 mm
minimum creepage distance (III/3)	12.5 mm
Rated insulation voltage (III/2)	1000 V
Rated surge voltage (III/2)	8 kV
minimum clearance value - non-homogenous field (III/2)	8 mm
minimum creepage distance (III/2)	8 mm
Rated insulation voltage (II/2)	1000 V
Rated surge voltage (II/2)	6 kV
minimum clearance value - non-homogenous field (II/2)	5.5 mm
minimum creepage distance (II/2)	5.5 mm

Environmental and real-life conditions

Vibration test

Specification	IEC 60068-2-6:2007-12
Frequency	10 - 150 - 10 Hz

PCV 6-16/ 3-G1-10,16 - PCB header



1998797

<https://www.phoenixcontact.com/us/products/1998797>

Sweep speed	1 octave/min
Amplitude	0.35 mm (10 Hz ... 60.1 Hz)
Sweep speed	5g (60.1 Hz ... 150 Hz)
Test duration per axis	2.5 h

Durability test

Specification	IEC 60512-9-1:2010-03
Impulse withstand voltage at sea level	9.8 kV
Contact resistance R ₁	0.5 mΩ
Contact resistance R ₂	0.5 mΩ
Insertion/withdrawal cycles	25
Insulation resistance, neighboring positions	> 5 MΩ

Climatic test

Specification	ISO 6988:1985-02
Corrosive stress	0.2 dm ³ SO ₂ on 300 dm ³ /40 °C/1 cycle
Thermal stress	100 °C/168 h
Power-frequency withstand voltage	4.26 kV

Ambient conditions

Ambient temperature (operation)	-40 °C ... 100 °C (dependent on the derating curve)
Ambient temperature (storage/transport)	-40 °C ... 70 °C
Relative humidity (storage/transport)	30 % ... 70 %
Ambient temperature (assembly)	-5 °C ... 100 °C

Packaging specifications

Type of packaging	packed in cardboard
-------------------	---------------------

Drawings

Diagram

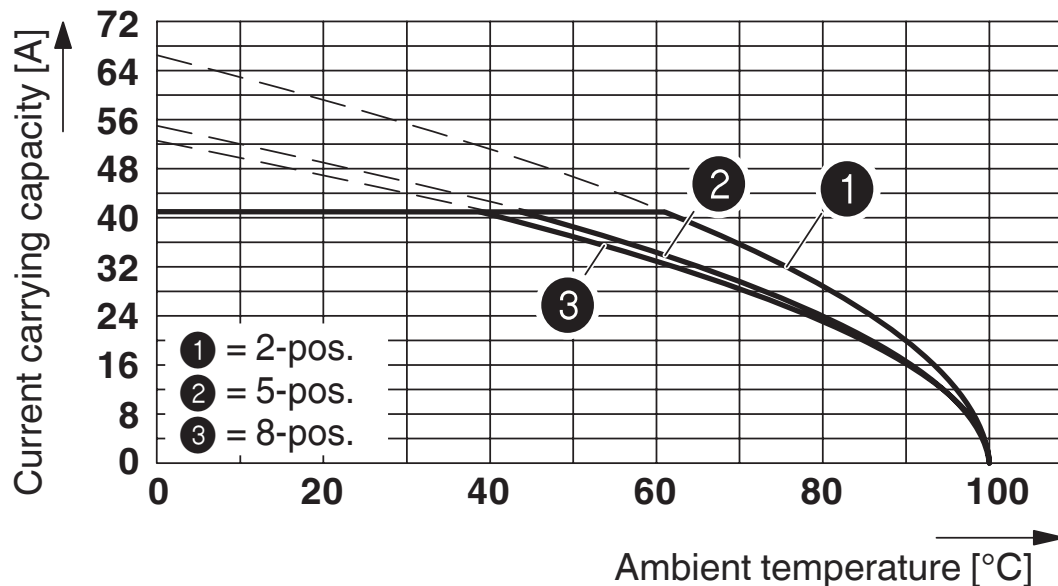

Derating curve for: PC 6/...-ST-10,16 with PCV 6-16/...-G1-10,16

Diagram

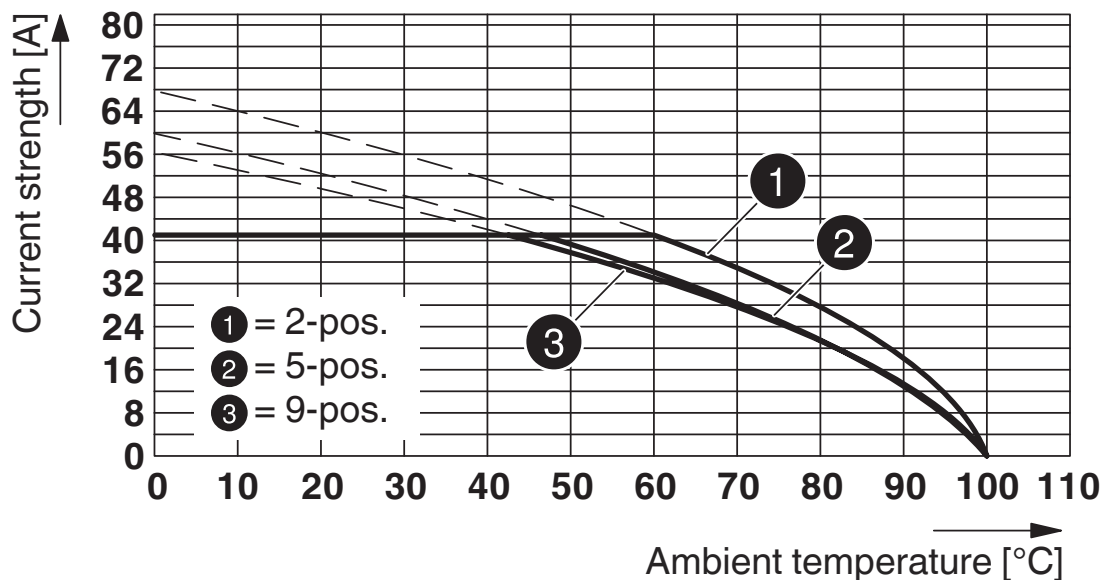

Type: PCU 6/...-STD-10,16 with PCV 6-16/...-G1-10,16

PCV 6-16/ 3-G1-10,16 - PCB header



1998797

<https://www.phoenixcontact.com/us/products/1998797>

Diagram

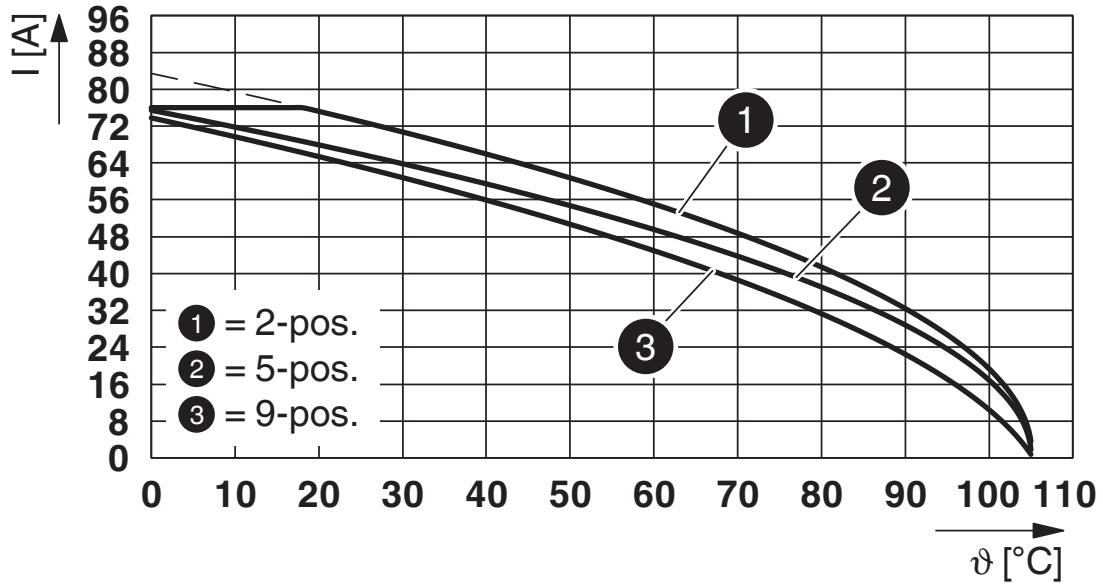

Type: PC 16/...-ST-10,16 with PCV 6-16/...-G1-10,16

Diagram

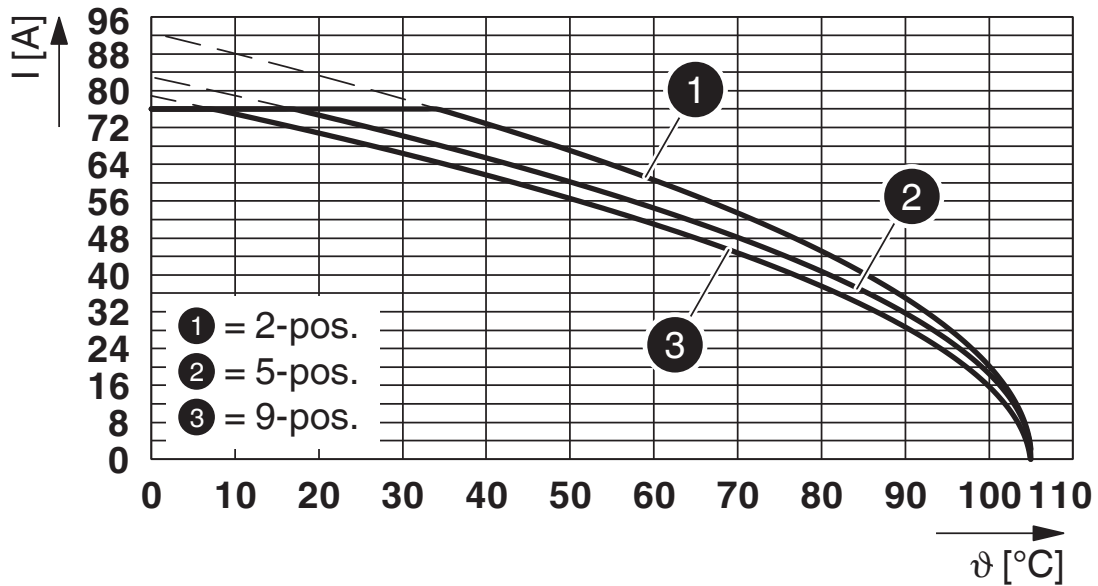

Type: SPC 16/...-ST-10,16 with PCV 6-16/...-G1-10,16

PCV 6-16/ 3-G1-10,16 - PCB header



1998797

<https://www.phoenixcontact.com/us/products/1998797>

Dimensional drawing

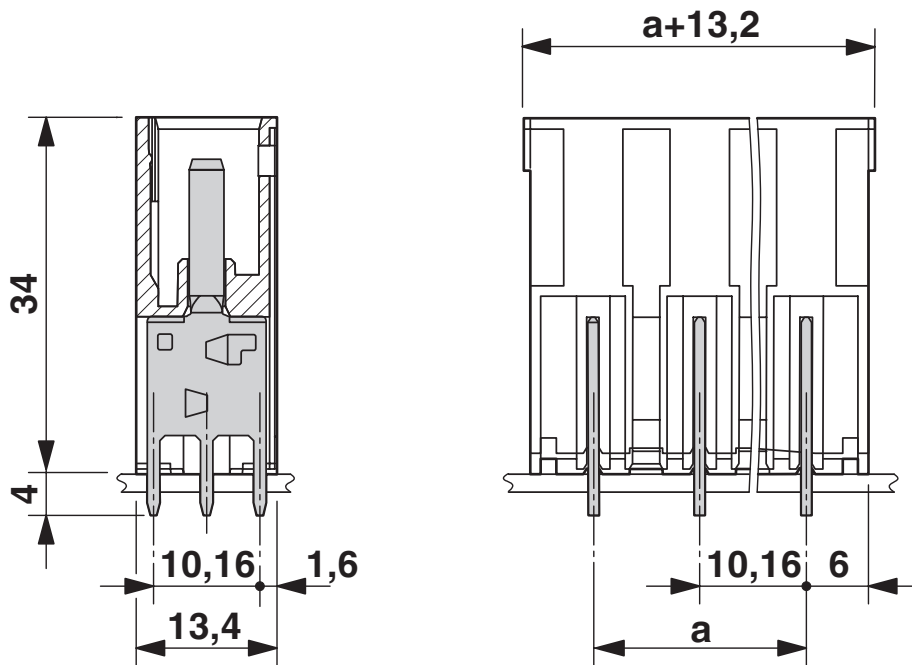

Drilling plan/solder pad geometry

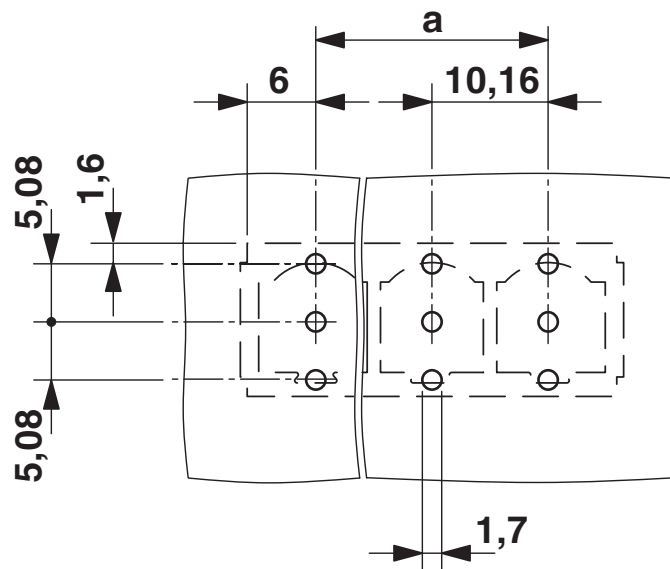

PCV 6-16/ 3-G1-10,16 - PCB header





1998797

<https://www.phoenixcontact.com/us/products/1998797>

Approvals

To download certificates, visit the product detail page: <https://www.phoenixcontact.com/us/products/1998797>

 cULus Recognized Approval ID: E60425-20040202				
	Nominal voltage U_N	Nominal current I_N	Cross section AWG	Cross section mm^2
Use group B	300 V	66 A	-	-
Use group C	300 V	66 A	-	-
Use group D	600 V	5 A	-	-

 VDE Zeichengenehmigung Approval ID: 40055586				
	Nominal voltage U_N	Nominal current I_N	Cross section AWG	Cross section mm^2
	1000 V	76 A	-	-

PCV 6-16/ 3-G1-10,16 - PCB header



1998797

<https://www.phoenixcontact.com/us/products/1998797>

Classifications

ECLASS

ECLASS-11.0	27460201
ECLASS-12.0	27460201
ECLASS-13.0	27460201

ETIM

ETIM 9.0	EC002637
----------	----------

UNSPSC

UNSPSC 21.0	39121400
-------------	----------

PCV 6-16/ 3-G1-10,16 - PCB header



1998797

<https://www.phoenixcontact.com/us/products/1998797>

Environmental product compliance

China RoHS	Environmentally friendly use period: unlimited = EFUP-e
	No hazardous substances above threshold values

PCV 6-16/ 3-G1-10,16 - PCB header



1998797

<https://www.phoenixcontact.com/us/products/1998797>

Accessories

CP-PC RD - Coding profile

1701967

<https://www.phoenixcontact.com/us/products/1701967>

Coding profile, for plugging into the coding ribs of the plug at a later date, insulating material, color: Red

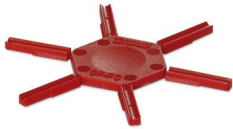

DFK-IPC 16/ 3-ST-10,16 - Feed-through plug

1703700

<https://www.phoenixcontact.com/us/products/1703700>

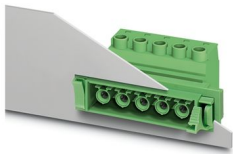

Feed-through connector, nominal cross section: 16 mm², color: green, nominal current: 76 A, rated voltage (III/2): 1000 V, contact surface: Silver, contact connection type: Socket, number of potentials: 3, number of rows: 1, number of positions: 3, number of connections: 3, product range: DFK-IPC 16/..-ST, pitch: 10.16 mm, connection method: Screw connection with tension sleeve, screw head form: L Slotted, conductor/PCB connection direction: 0 °, plug-in system: COMBICON PC 16, Pin connector pattern alignment: Standard, locking: without, mounting: without, type of packaging: packed in cardboard

PCV 6-16/ 3-G1-10,16 - PCB header

1998797

<https://www.phoenixcontact.com/us/products/1998797>

SPC 16/ 3-ST-10,16 - PCB connector

1711271

<https://www.phoenixcontact.com/us/products/1711271>

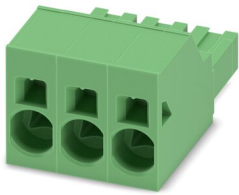

PCB connector, nominal cross section: 16 mm², color: green, nominal current: 76 A, rated voltage (III/2): 1000 V, contact surface: Silver, contact connection type: Socket, number of potentials: 3, number of rows: 1, number of positions: 3, number of connections: 3, product range: SPC 16/...-ST, pitch: 10.16 mm, connection method: Push-in spring connection, conductor/PCB connection direction: 0 °, locking clip: - without locking clip, plug-in system: COMBICON PC 16, locking: without, mounting: without, type of packaging: packed in cardboard

TPC 16/ 3-ST-10,16 - PCB connector

1715183

<https://www.phoenixcontact.com/us/products/1715183>



PCB connector, nominal cross section: 16 mm², color: green, nominal current: 76 A, rated voltage (III/2): 1000 V, contact surface: Silver, contact connection type: Socket, number of potentials: 3, number of rows: 1, number of positions: 3, number of connections: 6, product range: TPC 16/...-ST, pitch: 10.16 mm, connection method: Screw connection with tension sleeve, screw head form: L Slotted, conductor/PCB connection direction: 50 °, locking clip: - without locking clip, plug-in system: COMBICON PC 16, locking: without, mounting: without, type of packaging: packed in cardboard

PCV 6-16/ 3-G1-10,16 - PCB header



1998797

<https://www.phoenixcontact.com/us/products/1998797>

PC 6/ 3-ST-10,16 - PCB connector

1913510

<https://www.phoenixcontact.com/us/products/1913510>



PCB connector, nominal cross section: 6 mm², color: green, nominal current: 41 A, rated voltage (III/2): 1000 V, contact surface: Silver, contact connection type: Socket, number of potentials: 3, number of rows: 1, number of positions: 3, number of connections: 3, product range: PC 6/...-ST, pitch: 10.16 mm, connection method: Screw connection with tension sleeve, screw head form: L Slotted, conductor/PCB connection direction: 0 °, locking clip: - without locking clip, plug-in system: COMBICON PC 16, locking: without, mounting: without, type of packaging: packed in cardboard

PC 16/ 3-ST-10,16 - PCB connector

1967388

<https://www.phoenixcontact.com/us/products/1967388>



PCB connector, nominal cross section: 16 mm², color: green, nominal current: 76 A, rated voltage (III/2): 1000 V, contact surface: Silver, contact connection type: Socket, number of potentials: 3, number of rows: 1, number of positions: 3, number of connections: 3, product range: PC 16/...-ST, pitch: 10.16 mm, connection method: Screw connection with tension sleeve, screw head form: L Slotted, conductor/PCB connection direction: 0 °, locking clip: - without locking clip, plug-in system: COMBICON PC 16, locking: without, mounting: without, type of packaging: packed in cardboard

Phoenix Contact 2023 © - all rights reserved
<https://www.phoenixcontact.com>

Phoenix Contact USA
586 Fulling Mill Road
Middletown, PA 17057, United States
(+717) 944-1300
info@phoenixcon.com