

SP3003 Series 0.65pF Diode Array

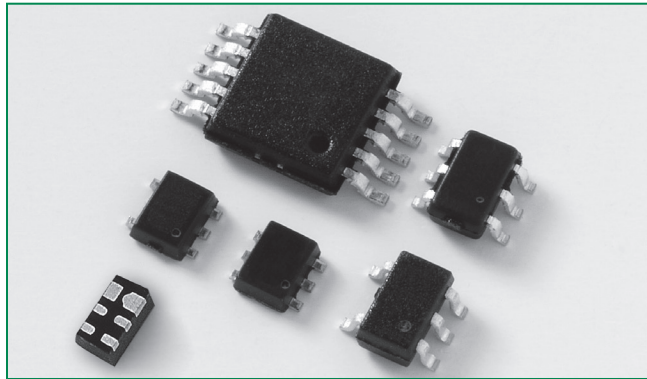

Pinout

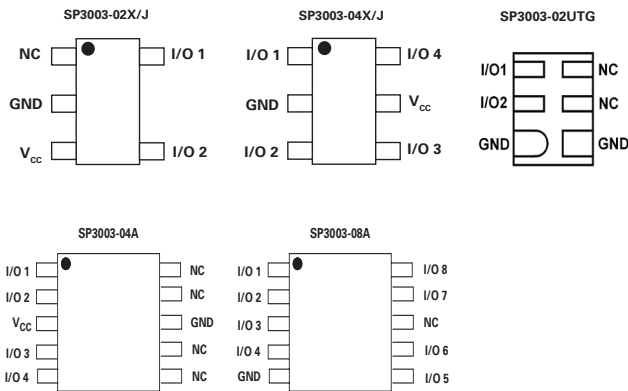

Functional Block Diagram

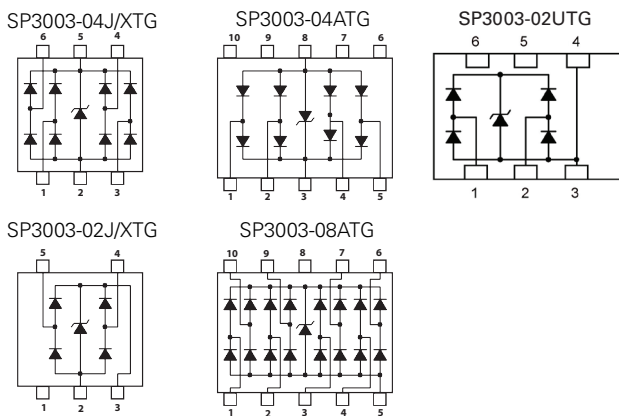

Description

The SP3003 has ultra low capacitance rail-to-rail diodes with an additional zener diode fabricated in a proprietary silicon avalanche technology to protect each I/O pin providing a high level of protection for electronic equipment that may experience destructive electrostatic discharges (ESD). These robust diodes can safely absorb repetitive ESD strikes at the maximum level specified in the IEC 61000-4-2 international standard (Level 4, ±8kV contact discharge) without performance degradation. Their very low loading capacitance also makes them ideal for protecting high speed signal pins such as HDMI, DVI, USB2.0, and IEEE 1394.

Features

- ESD protection of ±8kV contact discharge, ±15kV air discharge, (IEC61000-4-2)
- EFT protection, IEC61000-4-4, 40A (5/50ns)
- Lightning Protection, IEC61000-4-5, 2.5A (8/20µs)
- Low capacitance of 0.65pF (TYP) per I/O
- Low leakage current of 0.5µA (MAX) at 5V
- Complete line of small packaging helps save board space (SC70, SOT553, SOT563, MSOP10, µDFN-6L)

Applications

- LCD/ PDP TVs
- DVD Players
- Desktops
- MP3/ PMP
- Digital Cameras
- Set Top Boxes
- Mobile Phones
- Notebooks
- Computer Peripherals

Application Example

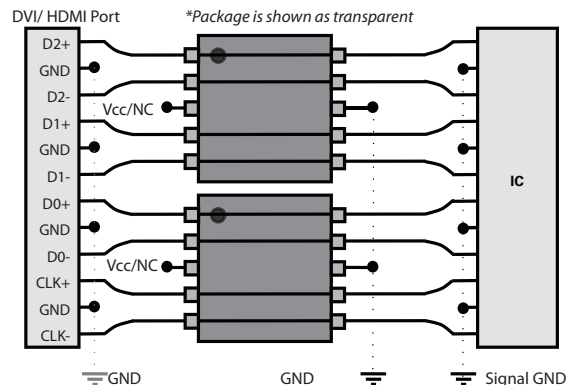

A single, 4 channel SP3003-04 device can be used to protect four (4) of the data lines in a HDMI/DVI interface so two (2) SP3003-04 devices provide protection for all eight (8) TMDS lines.

Life Support Note:
Not Intended for Use in Life Support or Life Saving Applications
The products shown herein are not designed for use in life sustaining or life saving applications unless otherwise expressly indicated.

Absolute Maximum Ratings

Symbol	Parameter	Value	Units
I_{PP}	Peak Current ($t_p=8/20\mu s$)	2.5	A
T_{OP}	Operating Temperature	-40 to 85	°C
T_{STOR}	Storage Temperature	-50 to 150	°C

CAUTION: Stresses above those listed in "Absolute Maximum Ratings" may cause permanent damage to the device. This is a stress only rating and operation of the device at these or any other conditions above those indicated in the operational sections of this specification is not implied.

Thermal Information

Parameter	Rating	Units
Storage Temperature Range	-65 to 150	°C
Maximum Junction Temperature	150	°C
Maximum Lead Temperature (Soldering 20-40s)	260	°C

Electrical Characteristics ($T_{OP}=25^\circ C$)

Parameter	Symbol	Test Conditions	Min	Typ	Max	Units
Reverse Standoff Voltage	V_{RWM}	$I_R \leq 1\mu A$			6	V
Reverse Leakage Current	I_{LEAK}	$V_R=5V$			0.5	μA
Clamp Voltage ¹	V_C	$I_{PP}=1A, t_p=8/20\mu s, Fwd$		10.0	12.0	V
		$I_{PP}=2A, t_p=8/20\mu s, Fwd$		11.8	15.0	V
ESD Withstand Voltage ¹	V_{ESD}	IEC61000-4-2 (Contact)	± 8			kV
		IEC61000-4-2 (Air)	± 15			kV
Diode Capacitance ¹	$C_{I/O-GND}$	Reverse Bias=0V	0.7	0.8	0.95	pF
		Reverse Bias=1.65V	0.55	0.65	0.8	pF
Diode Capacitance ¹	$C_{I/O-I/O}$	Reverse Bias=0V		0.35		pF

Note: 1. Parameter is guaranteed by design and/or device characterization.

Insertion Loss (S21) I/O to GND

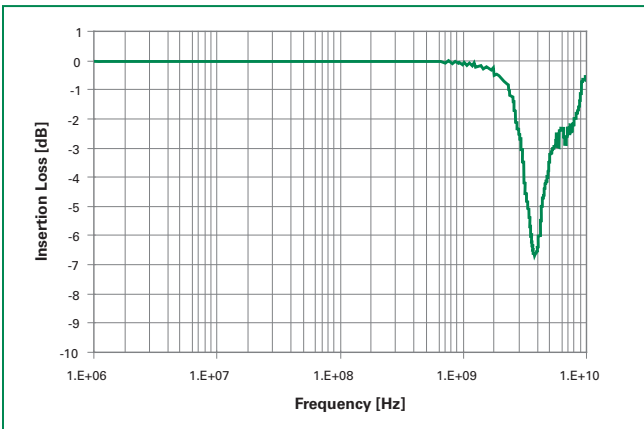

Capacitance vs. Bias Voltage

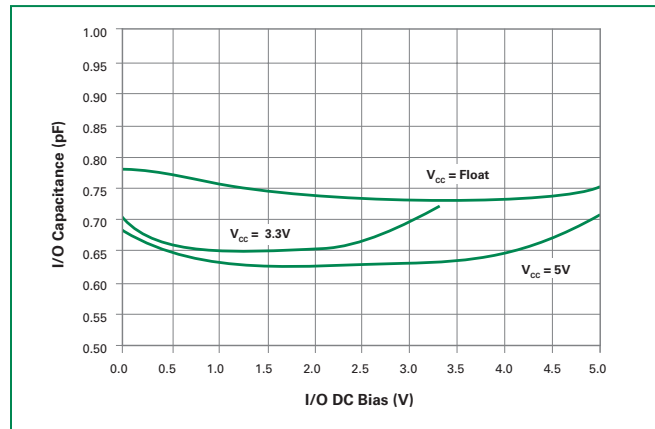

Capacitance vs. Frequency

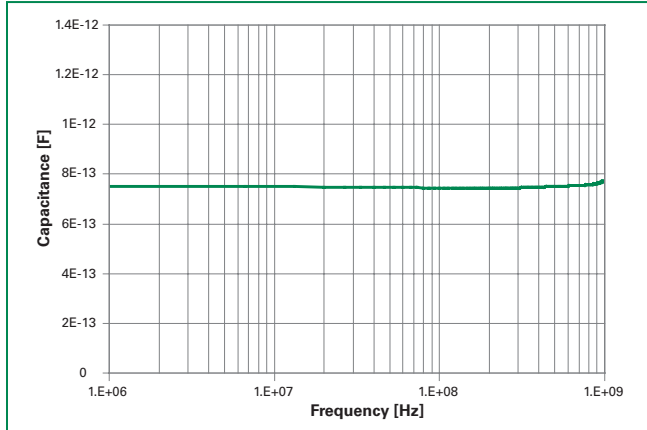

Product Characteristics

Lead Plating	Matte Tin (SC70-x, MSOP-10) Pre-Plated Frame (SOT5x3, μ DFN-6)
Lead Material	Copper Alloy
Lead Coplanarity	0.0004 inches (0.102mm)
Substitute Material	Silicon
Body Material	Molded Epoxy
Flammability	UL 94 V-0

- Notes :
1. All dimensions are in millimeters
 2. Dimensions include solder plating.
 3. Dimensions are exclusive of mold flash & metal burr.
 4. Blo is facing up for mold and facing down for trim/form, i.e. reverse trim/form.
 5. Package surface matte finish VDI 11-13.

Soldering Parameters

Reflow Condition		Pb – Free assembly
Pre Heat	- Temperature Min ($T_{s(min)}$)	150°C
	- Temperature Max ($T_{s(max)}$)	200°C
	- Time (min to max) (t_s)	60 – 180 secs
Average ramp up rate (Liquidus) Temp (T_L) to peak		3°C/second max
$T_{s(max)}$ to T_L - Ramp-up Rate		3°C/second max
Reflow	- Temperature (T_L) (Liquidus)	217°C
	- Temperature (t_L)	60 – 150 seconds
Peak Temperature (T_p)		260 ^{+0/-5} °C
Time within 5°C of actual peak Temperature (t_p)		20 – 40 seconds
Ramp-down Rate		6°C/second max
Time 25°C to peak Temperature (T_p)		8 minutes Max.
Do not exceed		260°C

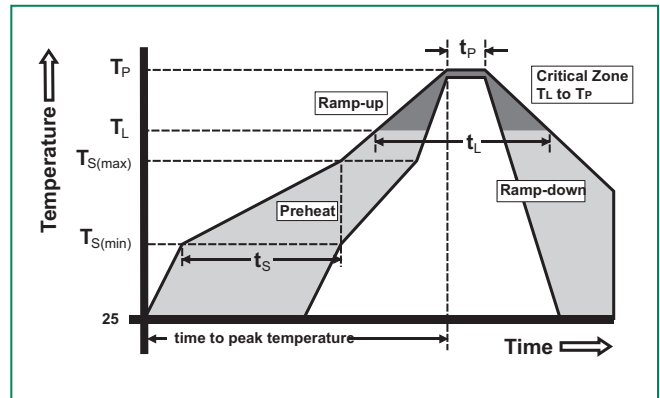

SP3003

Package Dimensions — SC70-5

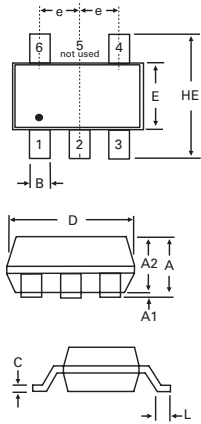

Recommended Solder Pad Layout

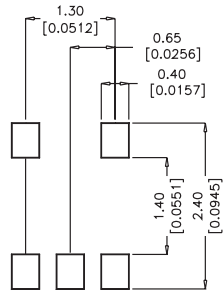

Package	SC70-5			
Pins	5			
JEDEC	MO-203			
	Millimeters		Inches	
	Min	Max	Min	Max
A	0.80	1.10	0.031	0.043
A1	0.00	0.10	0.000	0.004
A2	0.70	1.00	0.028	0.039
B	0.15	0.30	0.006	0.012
c	0.08	0.25	0.003	0.010
D	1.85	2.25	0.073	0.089
E	1.15	1.35	0.045	0.053
e	0.65 BSC		0.026 BSC	
HE	2.00	2.40	0.079	0.094
L	0.26	0.46	0.010	0.018

Package Dimensions — SC70-6

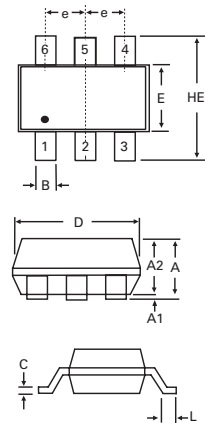

Recommended Solder Pad Layout

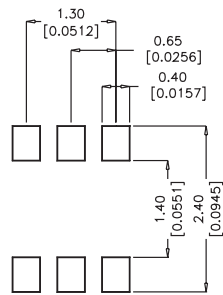

Package	SC70-6			
Pins	6			
JEDEC	MO-203			
	Millimeters		Inches	
	Min	Max	Min	Max
A	0.80	1.10	0.031	0.043
A1	0.00	0.10	0.000	0.004
A2	0.70	1.00	0.028	0.039
B	0.15	0.30	0.006	0.012
c	0.08	0.25	0.003	0.010
D	1.85	2.25	0.073	0.089
E	1.15	1.35	0.045	0.053
e	0.65 BSC		0.026 BSC	
HE	2.00	2.40	0.079	0.094
L	0.26	0.46	0.010	0.018

Package Dimensions — SOT553

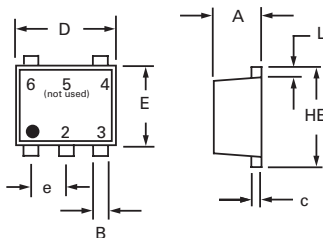

Recommended Solder Pad Layout

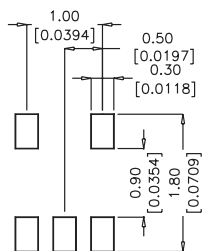

Package	SOT 553			
Pins	5			
	Millimeters		Inches	
	Min	Max	Min	Max
A	0.50	0.60	0.020	0.024
B	0.17	0.27	0.007	0.011
c	0.08	0.18	0.003	0.007
D	1.50	1.70	0.059	0.067
E	1.10	1.30	0.043	0.051
e	0.50 BSC		0.020 BSC	
L	0.10	0.30	0.004	0.012
HE	1.50	1.70	0.059	0.067

Package Dimensions – SOT563

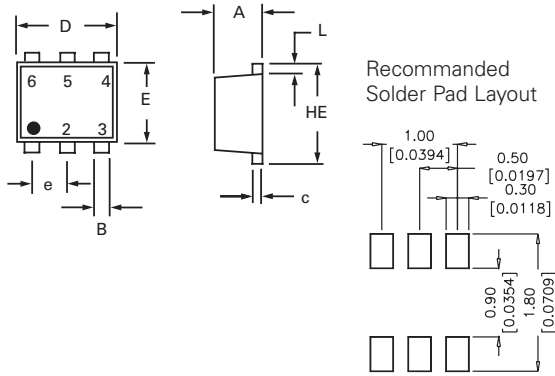

Package	SOT 563			
Pins	6			
	Millimeters		Inches	
	Min	Max	Min	Max
A	0.50	0.60	0.020	0.024
B	0.17	0.27	0.007	0.011
c	0.08	0.18	0.003	0.007
D	1.50	1.70	0.059	0.067
E	1.10	1.30	0.043	0.051
e	0.50 BSC		0.020 BSC	
L	0.10	0.30	0.004	0.012
HE	1.50	1.70	0.059	0.067

Package Dimensions – MSOP10

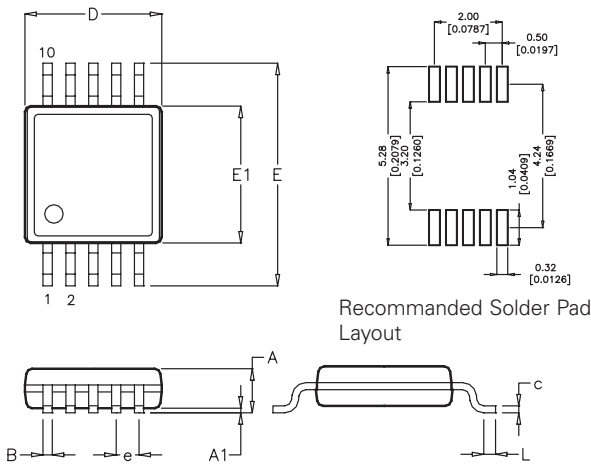

Package	MSOP10			
JEDEC	MO-187			
Pins	10			
	Millimeters		Inches	
	Min	Max	Min	Max
A	-	1.10	-	0.043
A1	0.00	0.15	0.000	0.006
B	0.17	0.27	0.007	0.011
c	0.08	0.23	0.003	0.009
D	2.90	3.10	0.114	0.122
E	4.67	5.10	0.184	0.200
E1	2.90	3.10	0.114	0.122
e	0.50 BSC		0.020 BSC	
HE	0.40	0.80	0.016	0.031

Package Dimensions – μDFN-6L

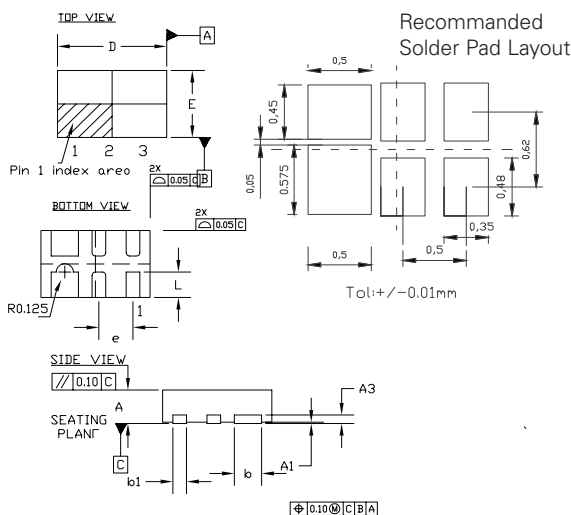

Package	μDFN-6L			
JEDEC	MO-229			
Pins	6			
	Millimeters		Inches	
	Min	Max	Min	Max
A	0.45	0.55	0.018	0.022
A1	0.00	0.05	0.000	0.002
A3	0.125REF		0.005REF	
b	0.35	0.45	0.014	0.018
b1	0.15	0.25	0.006	0.010
D	1.55	1.65	0.062	0.065
D2	-	-	-	-
E	0.95	1.05	0.038	0.042
E2	-	-	-	-
e	0.50REF		0.020REF	
L	0.33	0.43	0.013	0.017

Embossed Carrier Tape & Reel Specification – MSOP-10

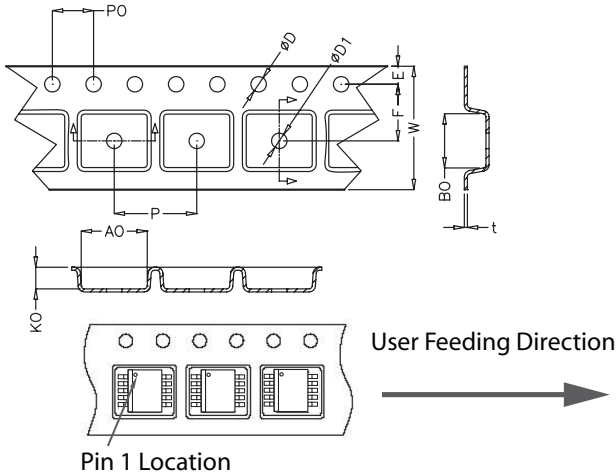

	Millimetres		Inches	
	Min	Max	Min	Max
E	1.65	1.85	0.065	0.073
F	5.40	5.60	0.213	0.220
D	1.50	1.60	0.059	0.063
D1	1.50 Min		0.059 Min	
P0	3.90	4.10	0.154	0.161
10P0	40.0+/- 0.20		1.574+/-0.008	
W	11.90	12.10	0.469	0.476
P	7.90	8.10	0.311	0.319
A0	5.20	5.40	0.205	0.213
B0	3.20	3.40	0.126	0.134
K0	1.20	1.40	0.047	0.055
t	0.30 +/- 0.05		0.012+/- 0.002	

Embossed Carrier Tape & Reel Specifications – SC70-5 and SC70-6

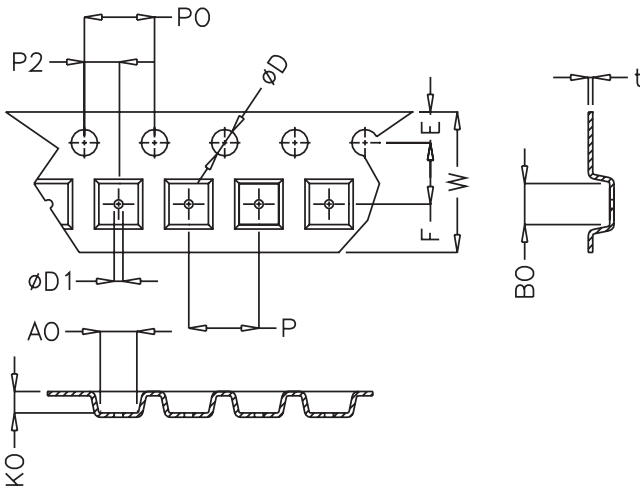

	Millimetres		Inches	
	Min	Max	Min	Max
E	1.65	1.85	0.064	0.073
F	3.45	3.55	0.135	0.139
P2	1.95	2.05	0.077	0.081
D	1.40	1.60	0.055	0.063
D1	1.00	1.25	0.039	0.049
P0	3.90	4.10	0.154	0.161
10P0	40.0+/- 0.20		1.574+/-0.008	
W	7.70	8.10	0.303	0.318
P	3.90	4.10	0.153	0.161
A0	2.14	2.34	0.084	0.092
B0	2.24	2.44	0.088	0.960
K0	1.12	1.32	0.044	0.052
t	0.27 max		0.010 max	

Embossed Carrier Tape & Reel Specifications – SOT553 and SOT563

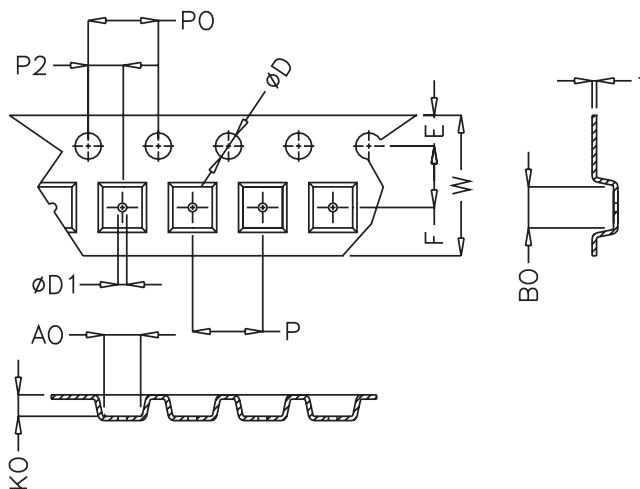

	Millimetres		Inches	
	Min	Max	Min	Max
E	1.65	1.85	0.064	0.073
F	3.45	3.55	0.135	0.139
P2	1.95	2.05	0.076	0.081
D	1.40	1.60	0.055	0.063
D1	0.45	0.55	0.017	0.021
P0	3.90	4.10	0.154	0.161
10P0	40.0+/- 0.20		1.574+/-0.008	
W	7.70	8.10	0.303	0.318
P	3.90	4.10	0.153	0.161
A0	1.73	1.83	0.068	0.072
B0	1.73	1.83	0.068	0.072
K0	0.64	0.74	0.025	0.029
t	0.22 max		0.009 max	

Embossed Carrier Tape & Reel Specification – μDFN-6L

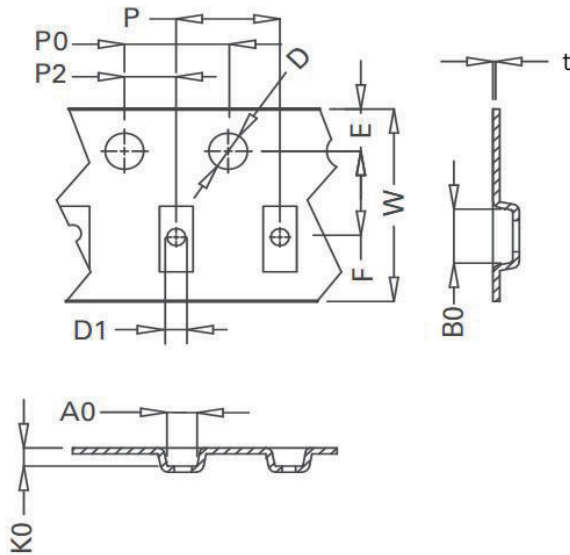

	Millimetres		Inches	
	Min	Max	Min	Max
E	1.65	1.85	0.064	0.073
F	3.45	3.55	0.135	0.139
P2	1.95	2.05	0.076	0.081
D	1.40	1.60	0.055	0.063
D1	0.45	0.55	0.017	0.021
P0	3.90	4.10	0.154	0.161
10P0	40.0+/-0.20		1.574+/-0.008	
W	7.90	8.30	0.311	0.319
P0	3.90	4.10	0.154	0.161
A0	1.15	1.25	0.045	0.049
B0	1.75	1.85	0.069	0.073
K0	0.65	0.75	0.026	0.03
t	0.22 max		0.009 max	

SP3003

Part Marking System

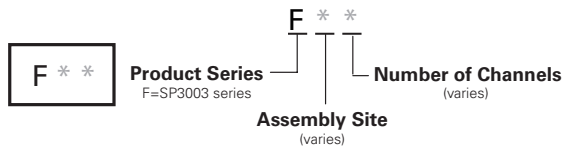

Ordering Information

Part Number	Package	Marking	Min. Order Qty.
SP3003-02JTG	SC70-5	F * 2	3000
SP3003-02UTG	μDFN-6L	FH2	3000
SP3003-02XTG	SOT553	F * 2	3000
SP3003-04ATG	MSOP-10	F * 4	4000
SP3003-04JTG	SC70-6	F * 4	3000
SP3003-04XTG	SOT563	F * 4	3000
SP3003-08ATG	MSOP-10	F * 8	4000

Part Numbering System

