



佛山市国星光电股份有限公司

FOSHAN NATIONSTAR OPTOELECTRONICS CO., LTD

SPECIFICATION

Customer		Product	Lamp Type LED
Customer No.		Type	BT-104GID-31-520G-B6

.....

APPROVED SIGNATURES			



Research & Development Center		
APPROVE	CHECK	DRAW
Version NO: A1		
Release Date : 2010-01-25		

BT-104GID-31-520G-B6 Lamp Type LED

Technical Data Sheet

This product is generally used as indicator and luminant for electronic equipment, for commercial and entertainment decorative lighting. And it's also widely used to make up variable indoor and outdoor message signal boards.

Features

- InGaN Green LED
- ϕ 5.0mm, Round Top Lamp
- Green diffused Package
- High Luminous Intensity and Low Power Dissipation
- Good Reliability and Long Life
- Complied with RoHS Directive

Catalogue

Electrical Characteristics.....	2
Dimension.....	3
Packaging.....	4
Reliability Test Items And Conditions.....	5
Soldering.....	6
Precautions.....	7

The Specifications of the product may be modified for improvement without notice.

◇ Absolute Maximum Ratings (Temperature=25°C)

Parameter	Symbol	Min.	Max.	Unit
Forward Current	I_F		30	mA
Pulse Forward Current*	I_{FP}		100	mA
Reverse Voltage	V_R		5	V
Operating Temperature	T_{OPR}	-25	+85	°C
Storage Temperature	T_{stg}	-40	+100	°C
Power Dissipation	P_D		135	mW

* Pulse Width: Max.10ms, Duty Ratio Max. 1/10

◇ Electro-Optical Characteristics (Temperature=25°C)

Parameter	Symbol	Condition	Min.	Typ.	Max.	Unit
Reverse Current	I_R	$V_R=5V$			10	μA
Forward Voltage	V_F	$I_F=20mA$		3.2	4.5	V
Dominant Wavelength	λ_D			520		nm
Peak Wavelength	λ_K			516		nm
Spectrum Radiation Bandwidth	$\Delta\lambda$			36		nm
Luminous Intensity	I_V				5500	
Viewing Angle	$2\theta_{1/2}$			30		(°)
ESD sensitivity (HBM)	V_{ESDS}		1			KV

◇ Dimension

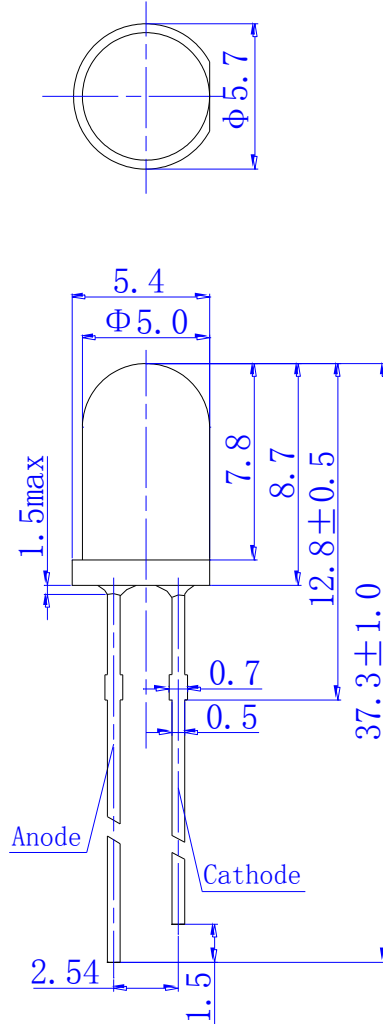

All dimensions in mm, tolerances unless mentioned is ± 0.2 mm.

✧ **Packaging**

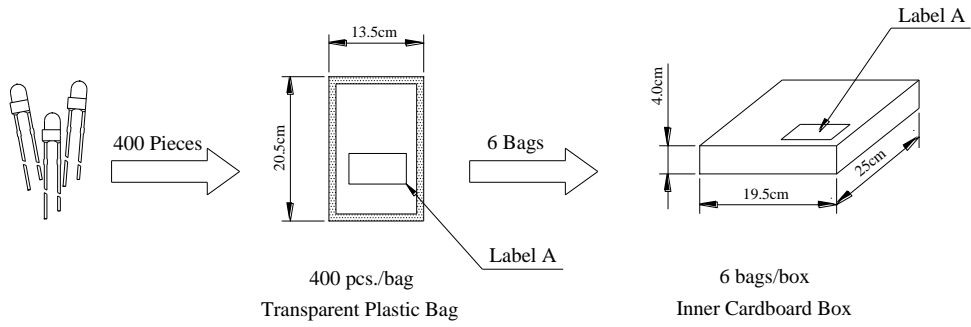

Label A

FOSHAN NATIONSTAR OPTOELECTRONICS CO.,LTD	
CERTIFICATION	
Part NO.	xxxxxx
Lot NO.	xxxxxx
Quantity	xxxxxx
QC.	QC PASS

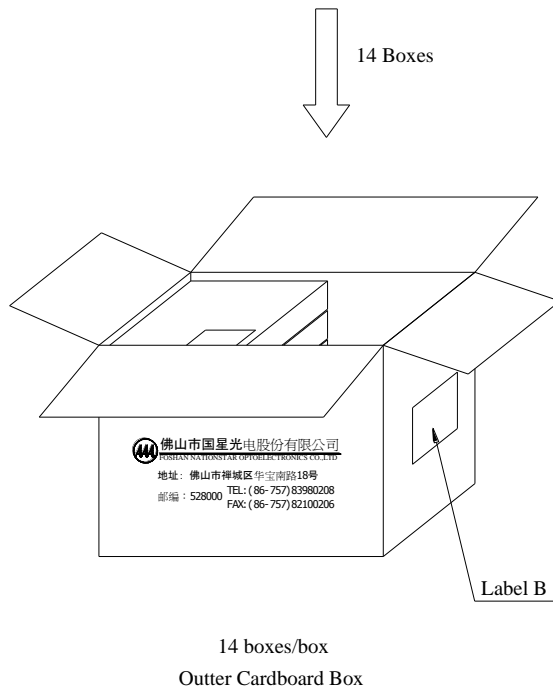

Label B

	FOSHAN NATIONSTAR OPTOELECTRONICS CO.,LTD
CERTIFICATION	
MODEL NO.	_____
LOT NO.	_____
QUANTITY	_____



Note: The Outer Cardboard Box is 40.5cm; 27.0cm; 40.0cm

◇ Reliability Test Items And Conditions:

Test Items	Test Conditions	Quantity	Judging Criteria
Solderability	Solder Temperature: $(235 \pm 5) ^\circ\text{C}$ Solder Duration: 5 sec.	15	Good Wetting
Resistance For Soldering Heat	$(260 \pm 5) ^\circ\text{C} \rightarrow 10 \text{ Sec.}$	15	I*
Thermal Shock Followed by High Temperature And High Humidity Cyclic	$-40^\circ\text{C} \rightarrow 10 \text{ min.}$ 5 Cycles  Shift (2~3) min. $100^\circ\text{C} \rightarrow 10 \text{ min.}$  $25^\circ\text{C} \sim 55^\circ\text{C}$ $(90\% \sim 95\%) \text{ RH}$ 2 Cycles for 48 hrs., Recover for 2 hrs.	20	I*
High Temperature And High Humidity Cyclic	$25^\circ\text{C} \sim 55^\circ\text{C}$ $(90\% \sim 95\%) \text{ RH}$ 6 Cycles for 144 hrs., Recover for 2 hrs.	20	I*
DC Operating Life	1000 hrs. Forward Current: 30mA	10	I**
High Temperature Storage	$100^\circ\text{C} \rightarrow 1000 \text{ hrs.}$	15	I**
Terminal Strength	Pull Test: 5N $\rightarrow 30 \text{ sec.}$ Bending Test: 2.5N $\rightarrow 2 \text{ times}$	15	No Damaged

*** Judging Criteria**

Items	Symbol	Test Conditions	Judging Criteria I*	Judging Criteria I**
Forward Voltage	V_F	$I_F=20\text{mA}$	$\leq \text{USL}$	$\leq \text{USL} \times 1.2$
Reverse Current	I_R	$V_R=5\text{V}$	$\leq \text{USL}$	$\leq \text{USL} \times 2.0$
Luminous Intensity	I_V	$I_F=20\text{mA}$	$\geq \text{LSL}$	$\geq \text{IL} \times 0.5$

* USL: Upper Standard Level, LSL: Lower Standard Level, IL: Initial Level *

❖ Soldering

Be careful because damages always caused during soldering. Please note that stress to the Leads and exposed bulb should be avoided during soldering particularly when heated. When soldering, leave certain distance from soldering joint to base, the distance is determined by different soldering techniques. It is recommended that soldering be performed base on the following conditions.

Recommended Soldering Conditions:

DIP Soldering		Hand Soldering	
Pre-Heat	100 °C Max., 60 sec. Max.	Temperature	300 °C Max.
Bath Temperature	260 °C Max.		
Dipping Time	5 sec. Max.	Soldering Time	3 sec. Max.
Dipping Position	2 mm Min. (from soldering joint to base)	Soldering Position	4 mm Min. (from soldering joint to base)

- Either DIP Soldering or Hand Soldering should not be done more than one time.
- After soldering, the LEDs should be protected from mechanical shock or stress before the LEDs cool down to room temperature.
- Cut the leadframes after the LEDs return to room temperature.
- It is recommended that alcohol be used as a solvent for cleaning after soldering. When using other solvents, or other cleaning method it should be confirmed whether the solvents will dissolve the resin or not.

Note: This general guideline may not apply to all PCB designs and configurations of all soldering equipment. The technique in practice is influenced by many factors, it should be specialized base on the PCB designs and configurations of the soldering equipment..

◇ Precautions

1. Storage

Under the storage conditions of 30°C or less and humidity less than 70% RH, the LEDs can be storage for 3 months. Storage in a sealed container with moisture absorbent material can prolong the storage time to a certain extent. Bad storage conditions may cause the leadframes to corrode or degradation of LED characteristics. It is recommended that the LEDs be used as soon as possible.

2. Static electricity

Static electricity or surge voltage damages the LEDs. Damaged LEDs will show some unusual characteristic such as the forward voltage becomes lower, or the LEDs do not light at the low current, even not light.

All devices, equipment and machinery must be properly grounded. At the same time, it is recommended that wrist bands or anti-electrostatic gloves, anti-electrostatic containers be used when dealing with the LEDs.

3. Design Consideration

In designing a circuit, the current through each LED must not exceed the absolute maximum rating specified for each LED. In the meanwhile, resistors for protection should be applied, otherwise slight voltage shift will cause big current change, burn out may happen.

It is recommended to use Circuit A which regulates the current flowing through each LED rather than Circuit B. When driving LEDs with a constant voltage in Circuit B, the current through the LEDs may vary due to the variation in Forward Voltage (VF) of the LEDs. In the worst case, some LED may be subjected to stresses in excess of the Absolute Maximum Rating.

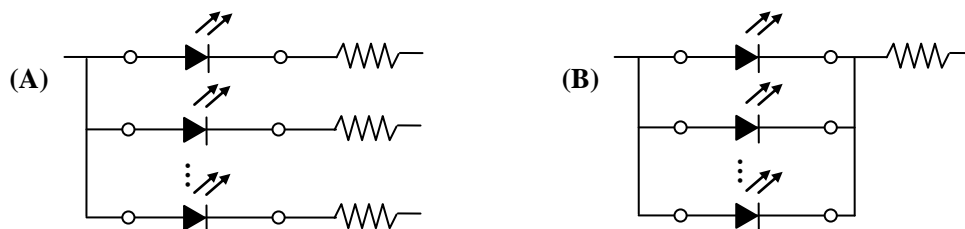

Thermal Design is paramount importance because heat generation may result in the Characteristics decline, such as brightness decreased, Color changed and so on. Please consider the heat generation of the LEDs when making the system design.

4. Lead Forming

Any lead forming must be done before soldering, not during or after soldering. When forming leads, the leads should be bent at a point at least 3mm from the base of the exposed bulb. Bending at the same point twice or even more should be avoided.

Please use proper tools to hold and bent the leads, do not use the base of the leadframe as a fulcrum during lead forming. Bending stress to the base of the leadframe may cause characteristics change on LED or even break it.

Just for the same reason, when mounting the LEDs onto a printed circuit board, the holes on the circuit board should be exactly aligned with the leads of the LEDs.

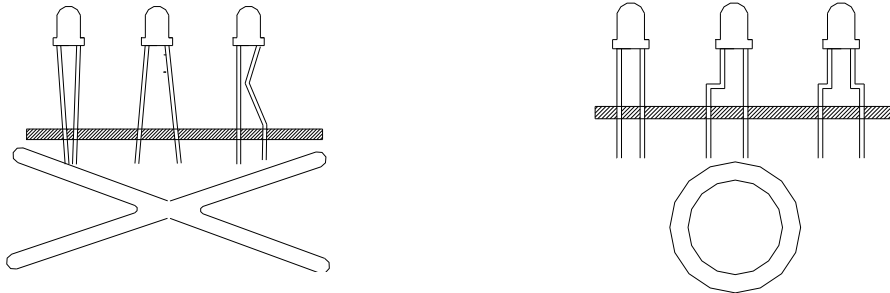

5. Safety Advice for Human Eyes

Viewing direct to the light emitting center of the LEDs, especially those of great Luminous Intensity, will cause great hazard to human eyes. Please be careful.