

Crystal Resonators

SMD Seam 3.2×2.5×0.7mm 7U Series



Approved by: 刘惠光

Checked by : 李相同

Issued by: 贺丹斌

SPECIFICATION

PN: ECN-7U20000MAF143ZA3

深圳市晶科鑫实业有限公司

SHENZHEN CRYSTAL TECHNOLOGY INDUSTRIAL CO., LTD.

Add: 12F, Bldg. 3C, TianAn Cloud Park Phase 1, Bantian, Longgang, Shenzhen, China

Tel: (86) 755 88352809 88352810

Fax: (86) 755 88353718 88352499

E-mail: SJK_William@q-crystal.com

HTTP://www.q-crystal.com

Page 1

Crystal Resonators

SMD Seam 3.2×2.5×0.7mm 7U Series



FEATURE

- Reliable seam sealed ceramic package.
- Wide operating temperature range.
- Superior performance and stringent reliability in harsh environment.
- Application: TPMS, ECM, ABS and sensor modules.
- Compact size.
- RoHS Compliant / Pb Free.

ELECTRICAL SPECIFICATIONS (电气参数)

Output Frequency Range	20.000MHz
Mode	AT/Fundamental
Frequency Tolerance (at 25°C)	±10ppm
Frequency Stability Over Operating Temperature Characteristics	±30ppm
Operating Temperature Range	-40°C to +85°C
Storage Temperature Range	-55°C to +125°C
Shunt Capacitance (C0)	3.0 PF Max
Driver Level (Typical)	100μW
Load Capacitance(CL)	16PF
Equivalent Series Resistance(ESR)	80Ω Max
Aging @25°C 1 st year (Max)	±3ppm/year

REMARK: SPECIFICATIONS SUBJECT TO CHANGE WITHOUT PRIOR NOTICE. PLEASE CONFIRM WITH OUR SALES ENGINEER.

Crystal Resonators

SMD Seam 3.2×2.5×0.7mm 7U Series



Dimension (尺寸) (Unit: mm)

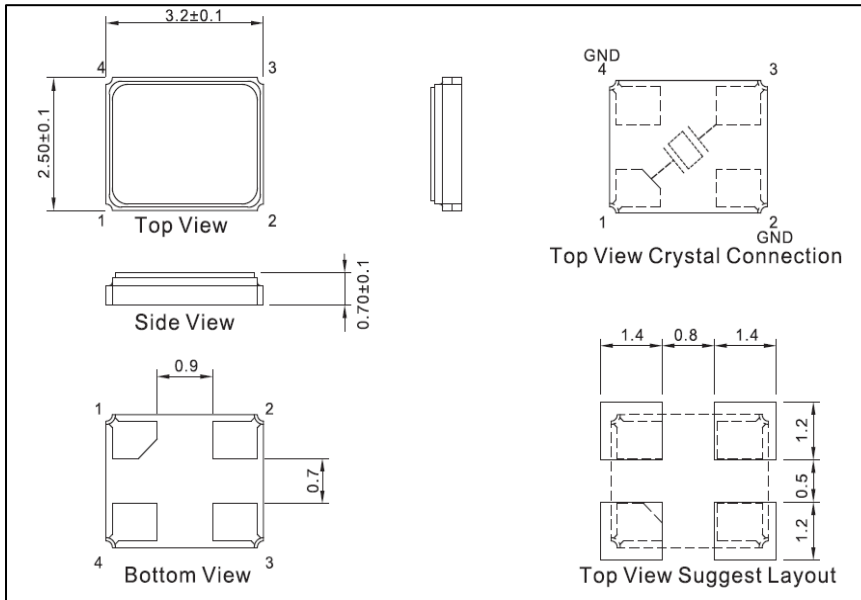

REFLOW CONDITION (回流焊)

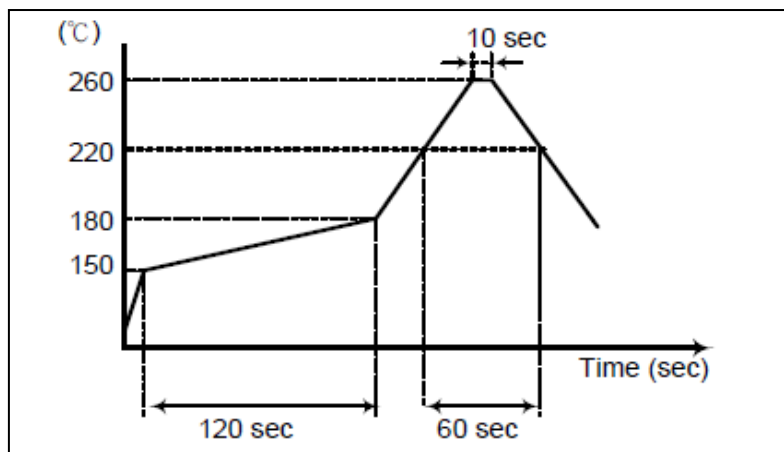

The reflow temperature profile may vary depending on the product model, specifications and frequency range. Refer to the individual product specifications for details

Crystal Resonators

SMD Seam 3.2×2.5×0.7mm 7U Series



CARRIER TYPE (載帶)

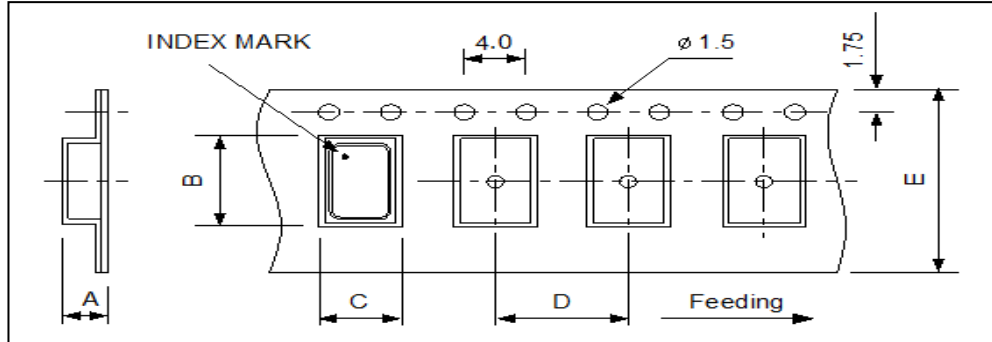

REEL(卷盘)

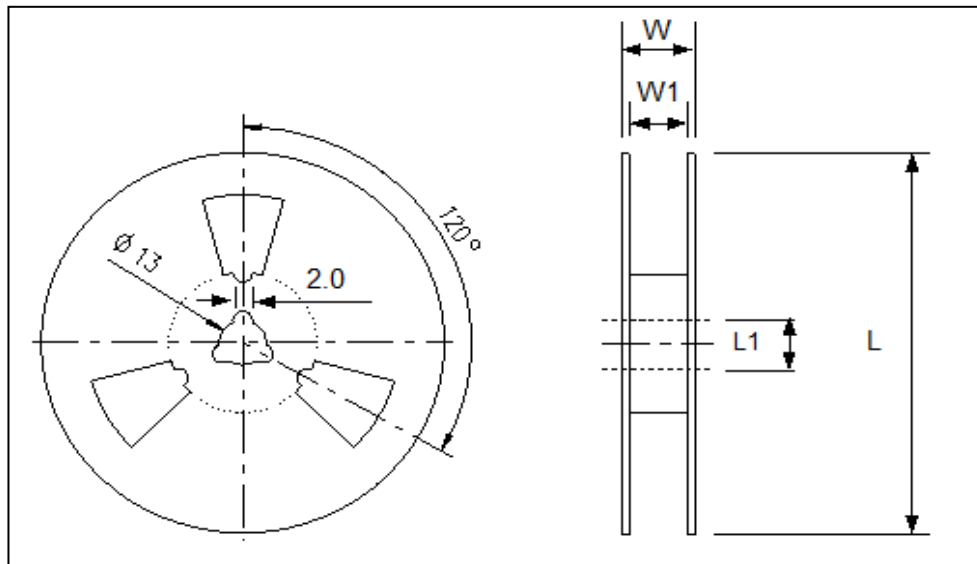

DIMENSIONS		A	B	C	D	E	L	L1	W	W1	pcs / Reel
	7050	2.15	7.9	5.4	8	16	180	13	21.5	17.5	1K
	6035	1.4	6.4	3.9	8	12	180	13	15.4	13	1K
	5032	1.46	5.5	3.6	8	12	180	13	15.4	13	1K
	3225	1.4	3.4	2.7	4	8	180	13	11.5	8	3K
	2520	1.15	2.8	2.25	4	8	180	13	10.5	8	3K
	2016	0.95	2.25	2.25	4	8	180	13	10.5	9	3K
	1612	0.8	2.0	1.85	4	8	180	13	10.5	9	3K
	1210	0.45	1.30	1.10	4	8	180	13	10.5	8	3K

Crystal Resonators

SMD Seam 3.2×2.5×0.7mm 7U Series



RELIABILITY TEST SPECIFICATIONS (可靠性测试标准)

Test item	Equipment	Condition	Specification
1.SOLDERABILITY TEST	SJK-REL001、RC-328A	1.Solderability:235±5℃, 5±0.5S 2.Heat resistance:260±5℃,10±1S restoration of 1 hour	MIL-STD-883E Method 2003.7
2. HERMETICITY TEST	HELIOT-306S	FC-84 FLUOROCARBON,BUBBLE MACHINE	MIL-STD-883E Method 1014.10
3. VIBRATION TEST	HG-V4、S&A 250B	Enable Crystal(10g) from 10-55-10Hz,X、Y、Z horizontal,1 Minute vibration/time, 1time/ 2 hours.	MIL-STD-883E Method 2007.3
4. MECHANICAL SHOCK	HPC-200、S&A 250B	Enable Crystal 50G(490m/s ²) time=11 ms speed=3.4 m/s half sine wave oscillation	JIS C6701
5. DROP TEST	HARD BOARD.S&A250B	75CM HIGH,3 TIMES ON HARD BOARD	MIL-STD-202F Method 213B
6. HIGH&LOW TEMP STORAGE TEST(Static test)	H-PTH-80CK & HM101-3ABN, S&A 350B/250B	High temperature: 125℃±2℃,1000hr; Low temperature:-40℃±3℃,1000hrs	MIL-STD883C, METHOD 1011.8
7. TEMP &HUM CYCLING TEST	H-PTH-80CK CHAMBE, S&A 350B/250B	Temperature:-10℃±2℃~65℃±2℃,Humidity:93±3%,1 cycle need 24 hrs. 5cycles.	MIL-STD-883E Method 1005.8
8. HIGH TEM. & HUM. STORAGE TEST	H-PTH-80CK CHAMBE, S&A350B/250B	Temperature:40℃±2, Humidity:85+3,-2%,Store 96 hrs	JIS C6701
9.AGING TEST	H-PTH-80CK CHAMBE, S&A350B/250	Temperature:40℃±2, Humidity:85+3,-2%,Store 96 hrs	JIS C5023

Add: 12F, Bldg. 3C, TianAn Cloud Park Phase 1, Bantian, Longgang, Shenzhen, China

Tel: (86) 755 88352809 88352810

Fax: (86) 755 88353718 88352499

E-mail: SJK_William@q-crystal.com

HTTP://www.q-crystal.com

Page 5