

Approved by: 刘惠光

Checked by : 李相同

Issued by: 贺丹斌

SPECIFICATION

PN: ECN-HC49S-4.000MHz-16pF

深圳市晶科鑫实业有限公司

SHENZHEN CRYSTAL TECHNOLOGY INDUSTRIAL CO., LTD.

Quartz Crystal Unit

HC-49S/SS 6B Series



FEATURE

- Surface mount type crystal units.
- A great number of standard frequencies.
- Higher frequency pullability and lower equivalent series resistance.
- Highly mass production capability.
- The best choice of TV,STB,LCDM and Cable Modem.
- RoHS Compliant/Pb Free.

ELECTRICAL SPECIFICATIONS (电气参数)

Output Frequency Range	4.000MHz
Mode	Fundamental
Frequency Tolerance (at 25°C)	±20ppm
Frequency Stability Over Operating Temperature Characteristics	±30ppm
Operating Temperature Range	-40°C to +85°C
Storage Temperature Range	-55°C to +125°C
Shunt Capacitance (C0)	≤7.0 PF Max
Driver Level (Typical)	100μW TYP
Load Capacitance(CL)	16PF
Equivalent Series Resistance(ESR)	150Ω Max
Insulation resistance	More than 500MΩ AT DC100V
Aging @25°C 1 st year (Max)	±3ppm/year

REMARK: SPECIFICATIONS SUBJECT TO CHANGE WITHOUT PRIOR NOTICE. PLEASE CONFIRM WITH OUR SALES ENGINEER.

Quartz Crystal Unit

HC-49S/SS 6B Series



Dimension (尺寸) (Unit: mm)

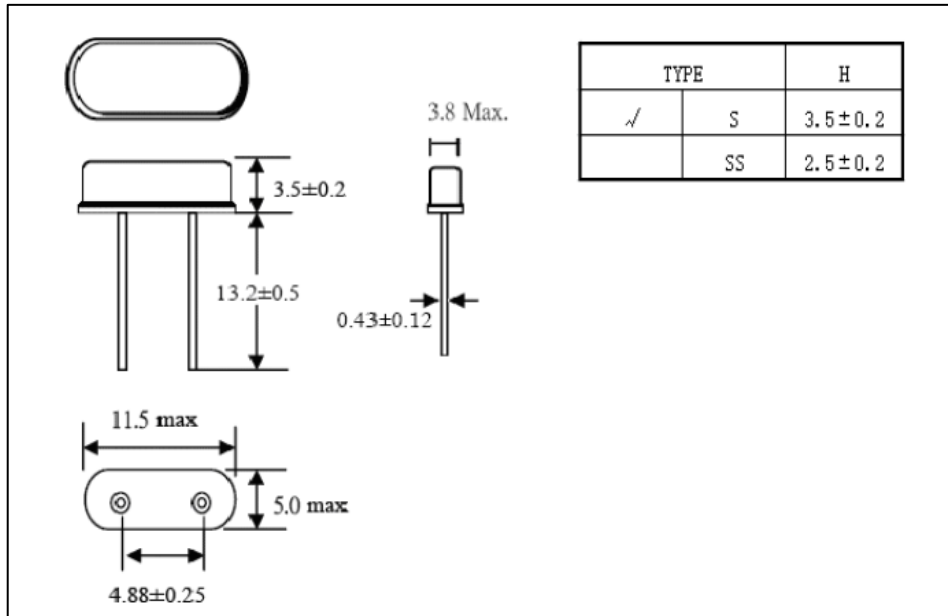

REFLOW CONDITION (回流焊)

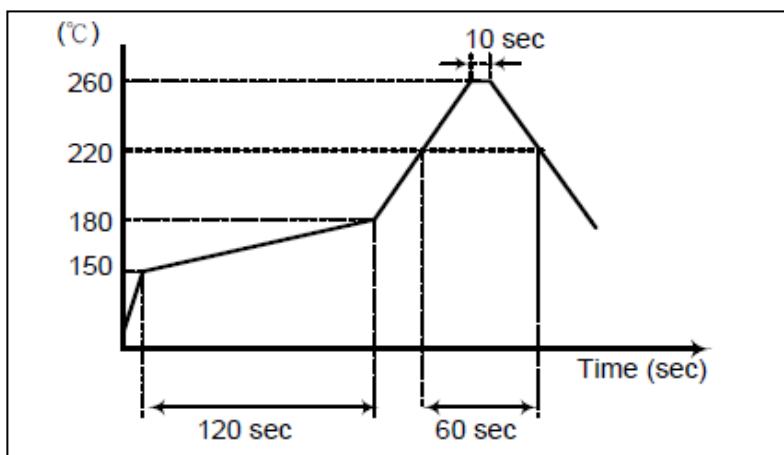

The reflow temperature profile may vary depending on the product model, specifications and frequency range. Refer to the individual product specifications for details

Quartz Crystal Unit

HC-49S/SS 6B Series



PACKING METHOD(包装)

Box: Packed 200PCS in 1 vinyl bag. Packed 5 vinyl bag in 1 box

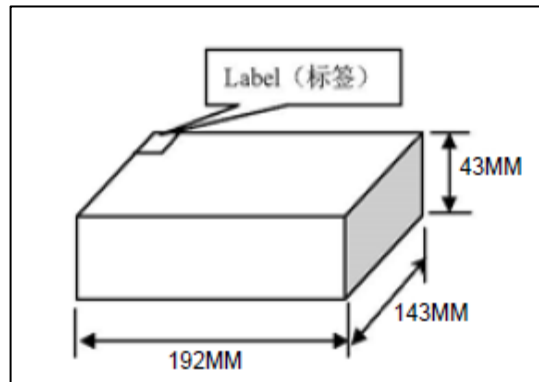

Carton: Packed 20 box in 1 carton, There are 20000Pcs in 1 carton.

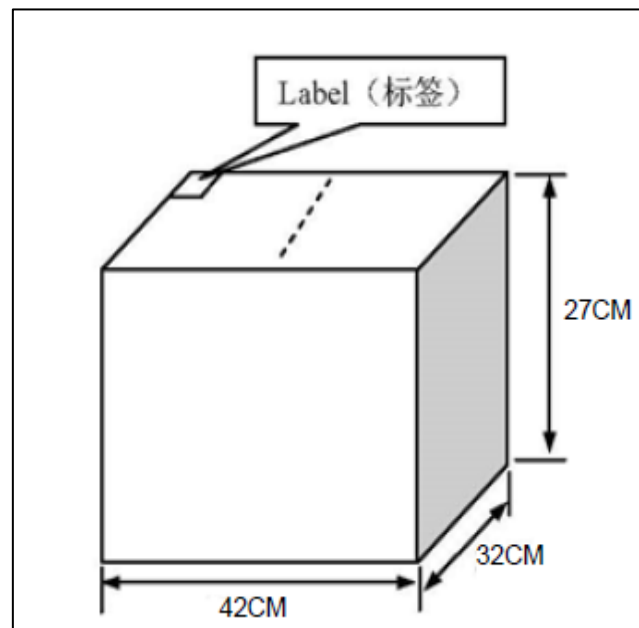

Quartz Crystal Unit

HC-49S/SS 6B Series



RELIABILITY TEST SPECIFICATIONS (可靠性测试标准)

Test item	Equipment	Condition	Specification
1.SOLDERABILITY TEST	SJK-REL001、RC-328A	1.Solderability:235±5℃, 5±0.5S 2.Heat resistance:260±5℃,10±1S restoration of 1 hour	MIL-STD-883E Method 2003.7
2. HERMETICITY TEST	HELIOT-306S	FC-84 FLUOROCARBON,BUBBLE MACHINE	MIL-STD-883E Method 1014.10
3. VIBRATION TEST	HG-V4、S&A 250B	Enable Crystal(10g) from 10-55-10Hz,X、Y、Z horizontal,1 Minute vibration/time, 1time/ 2 hours.	MIL-STD-883E Method 2007.3
4. MECHANICAL SHOCK	HPC-200、S&A 250B	Enable Crystal 50G(490m/s ²) time=11 ms speed=3.4 m/s half sine wave oscillation	JIS C6701
5. DROP TEST	HARD BOARD.S&A250B	75CM HIGH,3 TIMES ON HARD BOARD	MIL-STD-202F Method 213B
6. HIGH&LOW TEMP STORAGE TEST(Static test)	H-PTH-80CK & HM101-3ABN, S&A 350B/250B	High temperature: 125℃±2℃,1000hr; Low temperature:-40℃±3℃,1000hrs	MIL-STD883C, METHOD 1011.8
7. TEMP &HUM CYCLING TEST	H-PTH-80CK CHAMBE, S&A 350B/250B	Temperature:-10℃±2℃~65℃±2℃,Humidity:93±3%,1 cycle need 24 hrs. 5cycles.	MIL-STD-883E Method 1005.8
8. HIGH TEM. & HUM. STORAGE TEST	H-PTH-80CK CHAMBE, S&A350B/250B	Temperature:40℃±2, Humidity:85+3,-2%,Store 96 hrs	JIS C6701
9.AGING TEST	H-PTH-80CK CHAMBE, S&A350B/250	Temperature:40℃±2, Humidity:85+3,-2%,Store 96 hrs	JIS C5023

Add: 12F, Bldg. 3C, TianAn Cloud Park Phase 1, Bantian, Longgang, Shenzhen, China

Tel: (86) 755 88352809 88352810

Fax: (86) 755 88353718 88352499

E-mail: SJK_William@q-crystal.com

HTTP://www.q-crystal.com

Page 5