

**LCD MODULE**

MODULE NO. :

**KSECB1202-XXX-R01 SERIES****Customer:**

Approved by:

Approved by	Checked by	Prepared by

**RECORDS OF REVISION**

<b>Part Number</b>	<b>Revision</b>	<b>Revision Content</b>	<b>Revised on</b>
KSECB1202XXX-R01	1.0	First issue	Nov. 4th, 2022

**CONTENTS**

**1. FUNCTIONS & FEATURES ..... 4**

**2. MECHANICAL SPECIFICATIONS ..... 5**

**3. EXTERNAL DIMENSIONS ..... 6**

**4. BLOC`K DIAGRAM ..... 7**

**5. PIN ASSIGNMENT .....7**

**6. BACKLIGHT ELECTRICAL/OPTICAL SPECIFICATIONS ..... 8**

**7. MAXIMUM ABSOLUTE POWER RATINGS ..... 8**

**8. ELECTRICAL CHARACTERISTICS ..... 9**

**9. DISPLAY DATA RAM (DDRAM) ..... 10**

**10. INSTRUCTION TABLE ..... 11**

**11. INITIALIZING BY INSTRUCTION ..... 12**

**12. CHARACTER GENERATOR ROM ..... 13**

**14. RELIABILITY TEST ..... 16**

**15. INSPECTION SPECIFICATION ..... 17**

**16. LCD MODULES HANDLING PRECAUTIONS ..... 20**

**17. OTHERS ..... 20**

**1. MODULE CLASSIFICATION INFORMATION****KSE C B 1202 X X X - R 01**

① ② ③ ④ ⑤ ⑥ ⑦ ⑧ ⑨

① KSE: KEEN SIDE electronics

② C: Character Type, G: Graphic Type

③ B: COB, G: COG

④ Display Font: 12 \* 2

⑤ LCD Mode:

B→ STN-Blue Negative

F→ FSTN Positive

G→ STN Gray Positive

Y→ STN Yellow Green Positive

⑥ Backlight Type:

N→ Without backlight

A→ Amber LED backlight

B→ Blue LED backlight

G→ Green LED backlight

R→ Red LED backlight

W→ Withe LED backlight

Y→ Yellow-Green LED backlight

⑦ LCD Polarize Type/Temperature range/View direction :

D→ Transflective, W.T, 12:00

E→ Transmissive, W.T, 6:00

P→ Reflective, W. T, 6:00

Q→ Transmissive, W.T, 12:00

Z→ Transflective, W.T, 6:00

⑧ Character Bank :

A→ English / Japan

B→ English / European

R→ English / Cyrillic / Portuguese / Russian

T→ English / Russian

G→ Hebrew

⑨ Model serials no. :

**2. FUNCTIONS & FEATURES**

- KSECB1202XXX-R01 Series LCD type:
- Display Contents : 12 \* 2 Characters (5\*8 dots )
- Driving Scheme : 1/16 Duty; 1/5Bias
- Driver IC : AIP31066L-002
- Operating Voltage : 5.0V
- Interface :4/8-bit Parallel
- Operating Temperature :-20°C - +70°C
- Storage Temperature :-30°C - +80°C
- RoHS Compliant

**3. MECHANICAL SPECIFICATIONS**

- Outline Dimensions : 55.70(W) x 32.00(L) x 9.10max(H)(mm)
- Viewing Area : 46.00 (W) x 17.50(L)(mm)
- Active Area : 37.85 (W) x 11.70 (L)(mm)
- Character size : 2.65 (W) x 5.50(L)(mm)
- Character Pitch : 3.20 (W) x 6.20 (L)(mm)
- Dot Pitch : 0.55 (W) x 0.70(L)(mm)
- Dot Size : 0.45 (W) x 0.60 (L)(mm)
- Weight : TBD



**4. BLOCK DIAGRAM**

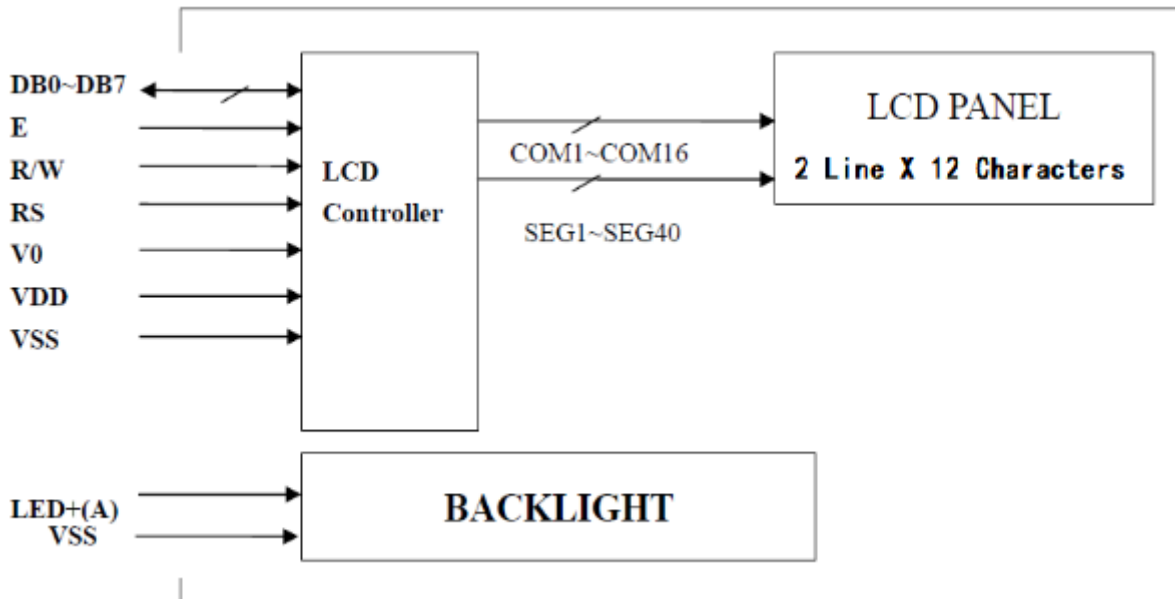

**6. PIN ASSIGNMENT**

Pin No.	Symbol	Function
1	VSS	Ground terminal of module.
2	VDD	Power terminal of module
3	V0	Power Supply for liquid crystal drive.
4	RS	Register select RS = 0...Instruction register RS = 1...Data register
5	R/W	Read /Write R/W = 1...Read R/W = 0...Write
6	E	Read/Write Enable Signal
7	DB0	Bi-directional data bus, data transfer is performed once, thru DB0 to DB7, in the case of interface data. Length is 8-bits; and twice, thru DB4 to DB7 in the case of interface data length is 4-bits. Upper four bits first then lower four bits.
8	DB1	
9	DB2	
10	DB3	
11	DB4	
12	DB5	
13	DB6	
14	DB7	
15	A	Anode of Backlight

**7. BACKLIGHT ELECTRICAL/OPTICAL SPECIFICATIONS**

**Electrical/Optical Specifications (Yellow-Green)**

ITEM	SYMBOL	MIN.	TYP.	MAX.	UNIT	CONDITIONS
Forward Voltage	V <sub>f</sub>	4.8	5.0	5.2	V	I <sub>f</sub> = 15 mA
Reverse Current	I <sub>r</sub>			100	μA	V <sub>r</sub> =5.0 V
Dominant wave length	λ <sub>D</sub>	569	572	575	nm	I <sub>f</sub> = 15 mA
Spectral Line Half width	Δ λ		25		nm	I <sub>f</sub> = 15 mA
Luminous	L <sub>v</sub>	70			cd/m <sup>2</sup>	I <sub>f</sub> = 15 mA

**Electrical/Optical Specifications (White)**

ITEM	SYMBOL	MIN.	TYP.	MAX.	UNIT	CONDITIONS
Forward Voltage	V <sub>f</sub>	4.8	5.0	5.2	V	I <sub>f</sub> = 15 mA
Reverse Current	I <sub>r</sub>			100	μA	V <sub>r</sub> =5.0 V
Dominant wave length	X	0.26	--	0.30		I <sub>f</sub> = 15 mA
	Y	0.26	--	0.30	-	
Spectral Line Half width	Δ λ		--		nm	I <sub>f</sub> = 15 mA
Luminous	L <sub>v</sub>	70			cd/m <sup>2</sup>	I <sub>f</sub> = 15 mA

**8. MAXIMUM ABSOLUTE POWER RATINGS**

ITEM	SYMBOL	STANDRADVALUE	UNIT
Power supply voltage(1)	VDD	-0.3~+7.0	V
Power supply voltage(2)	VLCD	VDD-10.0~VDD+0.3	V
Input voltage	VIN	-0.3~VDD+0.3	V
Operating temperature	T <sub>opr</sub>	-20~+70	°C
Storage temperature	T <sub>stg</sub>	-30~+80	°C

\*Voltage greater than above may damage to the Circuit.

$$VDD > V1 > V2 > V3 > V4 > V5$$



**9. ELECTRICAL CHARACTERISTICS**

**9-1 DC Characteristics**

Item	Symbol	Standard Value			Test Condition	Unit
		MIN	TYP	MAX		
Operating Voltage	V <sub>DD</sub>	4.8	5.0	5.2	-----	V
Supply Current	I <sub>DD1</sub>	----	TBD	1.0	Ceramic oscillation fosc=250kHz	mA
	I <sub>DD2</sub>	----	TBD	0.6	Resistor oscillation external clock operation fosc=270kHz	
LCD Driving Voltage	V <sub>LCD</sub>	4.5	4.7	4.9	V <sub>DD</sub> -V <sub>0</sub>	V

**9-2 AC Characteristics**

**9.2.1 Write mode**

Characteristic	Symbol	Min	Type	Max	Unit	Test PIN
Enable Cycle Time	t <sub>C</sub>	1200	---	---	ns	E
Enable Pulse Time	T <sub>PW</sub>	460	---	---	ns	E
Enable Rise/Fall Time	T <sub>R</sub> , T <sub>F</sub>	---	---	25	ns	E
Address Set-up Time	T <sub>AS</sub>	0	---	---	ns	R/W,RS,E
Address Hold Time	T <sub>AH</sub>	10	---	---	ns	R/W,RS,E
Data Set-up Time	T <sub>DSW</sub>	80	---	---	ns	DB0~DB7
Data Hold Time	T <sub>H</sub>	10	---	---	ns	DB0~DB7

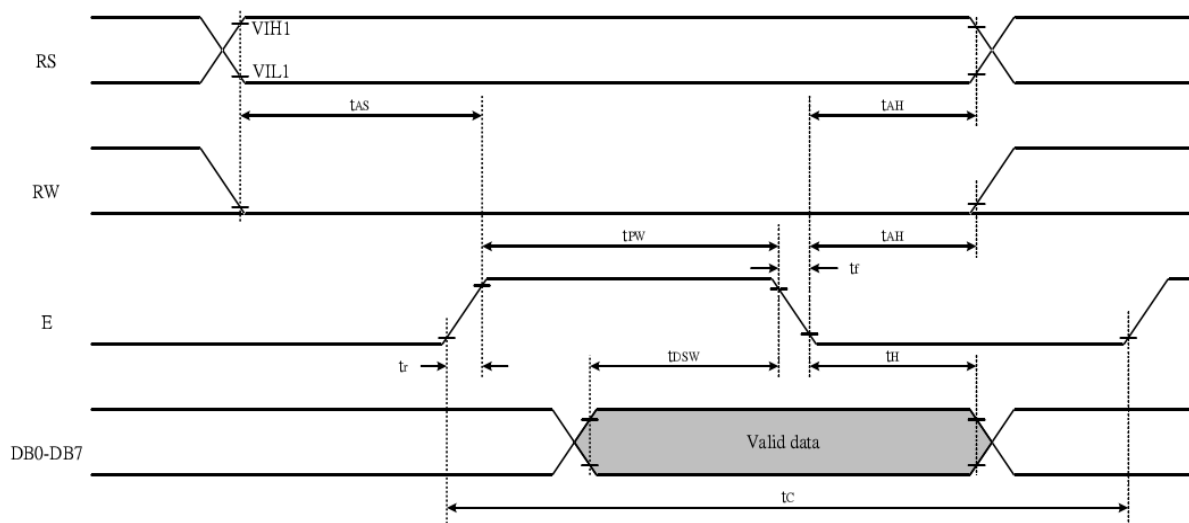

**9.2.2 Read mode**

Characteristic	Symbol	Min	Type	Max	Unit	Test PIN
Enable Cycle Time	$t_C$	1200	---	---	ns	E
Enable Pulse Time	$T_{PW}$	480	---	---	ns	E
Enable Rise/Fall Time	$T_R, T_F$	---	---	25	ns	E
Address Set-up Time	$T_{AS}$	0	---	---	ns	R/W,RS,E
Address Hold Time	$T_{AH}$	10	---	---	ns	R/W,RS,E
Data Set-up Time	$T_{DDR}$	---	---	320	ns	DB0~DB7
Data Hold Time	$T_H$	10	---	---	ns	DB0~DB7

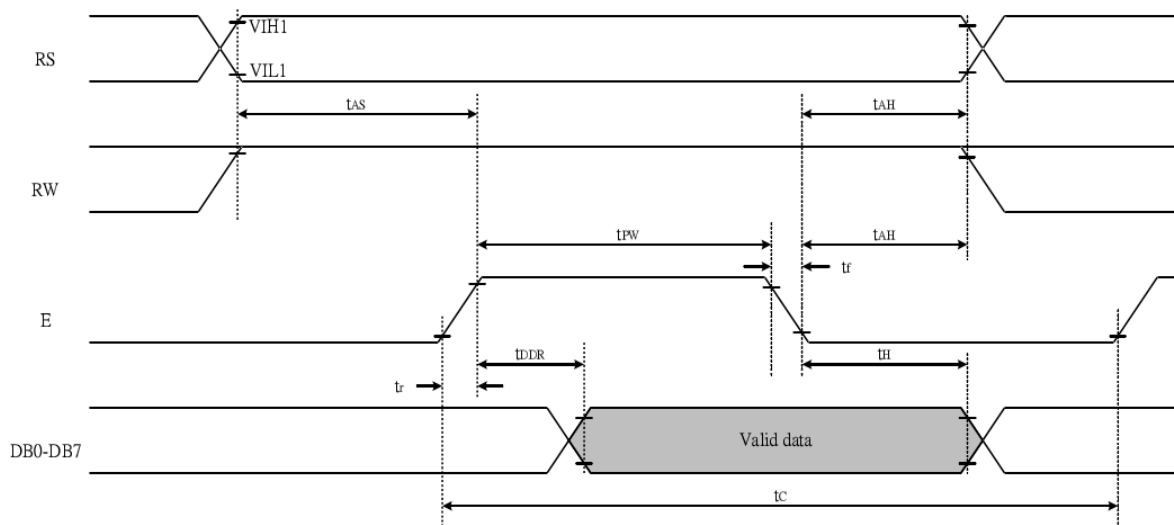

**10. DISPLAY DATA RAM (DDRAM)**

Display	1	2	3	4	5	6	7	8	9	10	11	12	13	14	15	16
Position	00	01	02	03	04	05	06	07	08	09	0A	0B	0C	0D	0E	0F
DDRAM Address	40	41	42	43	44	45	46	47	48	49	4A	4B	4C	4D	4E	4F

For Shift Left	01	02	03	04	05	06	07	08	09	0A	0B	0C	0D	0E	0F	10
	41	42	43	44	45	46	47	48	49	4A	4B	4C	4D	4E	4F	50

For Shift Right	27	00	01	02	03	04	05	06	07	08	09	0A	0B	0C	0D	0E
	67	40	41	42	43	44	45	46	47	48	49	4A	4B	4C	4D	4E

**11. INSTRUCTION TABLE**

Command	RS	R/W	DB7	DB6	DB5	DB4	DB3	DB2	DB1	DB0	Execution time (fosc=270KHz)	Remark
Clear Display	0	0	0	0	0	0	0	0	0	1	1.52ms	Write"20H" to DDRAM. And set DDRAM address to "00H" from AC
Return home	0	0	0	0	0	0	0	0	1	x	1.52ms	Set DDRAM address to "00H" from AC and return cursor to its original position if shifted. The contents of DDRAM are not changed.
Entry mode Set	0	0	0	0	0	0	0	1	I/D	S	37us	Sets cursor move direction and specifies display shift. These operations are performed during data write and read.
Display on/off control	0	0	0	0	0	0	1	D	C	B	37us	D=1: entire display on C=1: cursor on B=1: cursor position on
Cursor or Display Shift	0	0	0	0	0	1	S/C	R/L	x	x	37us	Set cursor moving and display shift control bit, and the direction, without changing DDRAM data.
function Set	0	0	0	0	1	DL	N	F	x	x	37us	DL: interface data is 8/4 bits N: number of line is 2/1 F: font size is 5x11/5x8
Set CGRAM address	0	0	0	1	AC5	AC4	AC3	AC2	AC1	AC0	37us	Set CGRAM address in address counter
Set DDRAM address	0	0	1	AC6	AC5	AC4	AC3	AC2	AC1	AC0	37us	Set DDRAM address in address counter
Read busy flag& address	0	1	BF	AC6	AC5	AC4	AC3	AC2	AC1	AC0	0us	Whether during internal operation or not can be known by reading BF. The contents of address counter can also be read.
Write data to RAM	1	0	D7	D6	D5	D4	D3	D2	D1	D0	37us	Write data into internal RAM (DDRAM/CGRAM)
Read data from RAM	1	1	D7	D6	D5	D4	D3	D2	D1	D0	37us	Read data from internal RAM (DDRAM /CGRAM)

**Note:**

Be sure the AIP31066 is not in the busy state (BF=00) before sending an instruction from the MPU to the AIP31066. If an instruction is sent without checking the busy flag, the time between the first instruction and next instruction will take much longer than the instruction time itself. Refer to instruction table for the list of each instruction execution time.

**12. INITIALIZING BY INSTRUCTION**

8-bit interface mode (fosc=270kHz)

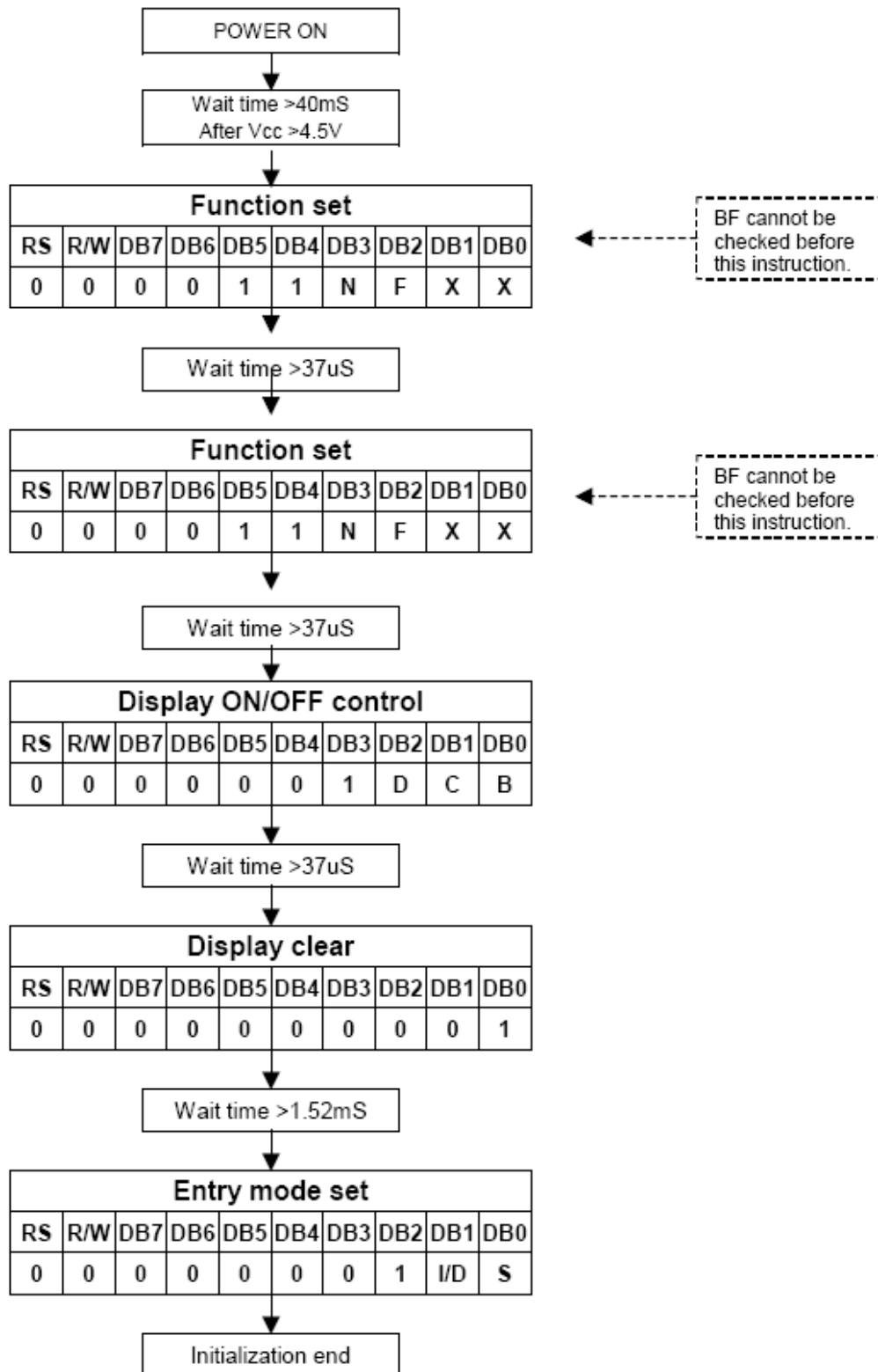

**13. CHARACTER GENERATOR ROM**

002

b7-b4 b3-b0	0000	0001	0010	0011	0100	0101	0110	0111	1000	1001	1010	1011	1100	1101	1110	1111
0000	CG RAM (1)			0	1	2	3	4			5	6	7	8	9	0
0001	(2)		!	1	A	Q	a	q			7	R	W	.	U	8
0010	(3)		"	2	B	R	b	r			E	S	Y	u	W	9
0011	(4)		#	3	C	S	c	s			8	B	W	0	A	4
0100	(5)		\$	4	D	T	d	t			3	T	F	Z	o	5
0101	(6)		%	5	E	U	e	u			M	E	a	X	U	6
0110	(7)		&	6	F	V	f	v			4	R	W	Z	W	7
0111	(8)		'	7	G	W	g	w			J	B	R	I	'	F
1000	(1)		<	8	H	X	h	x			7	N	o	U	'	8
1001	(2)		>	9	I	Y	i	y			V	R	o	t	'	9
1010	(3)		*	:	J	Z	j	z			o	K	o	v	e	0
1011	(4)		+	;	K	C	k	c			4	a	"	N	o	1
1100	(5)		,	<	L	o	l	o			W	N	R	N	o	2
1101	(6)		-	=	M	I	m	i			6	H	C	N	*	3
1110	(7)		.	>	N	^	n	^			B	n	Y	Z	o	4
1111	(8)		/	?	O	_	o	_			3	T	E	.	o	5

**14. Optical Characteristics**

**14.1 Definition of Viewing Angle**

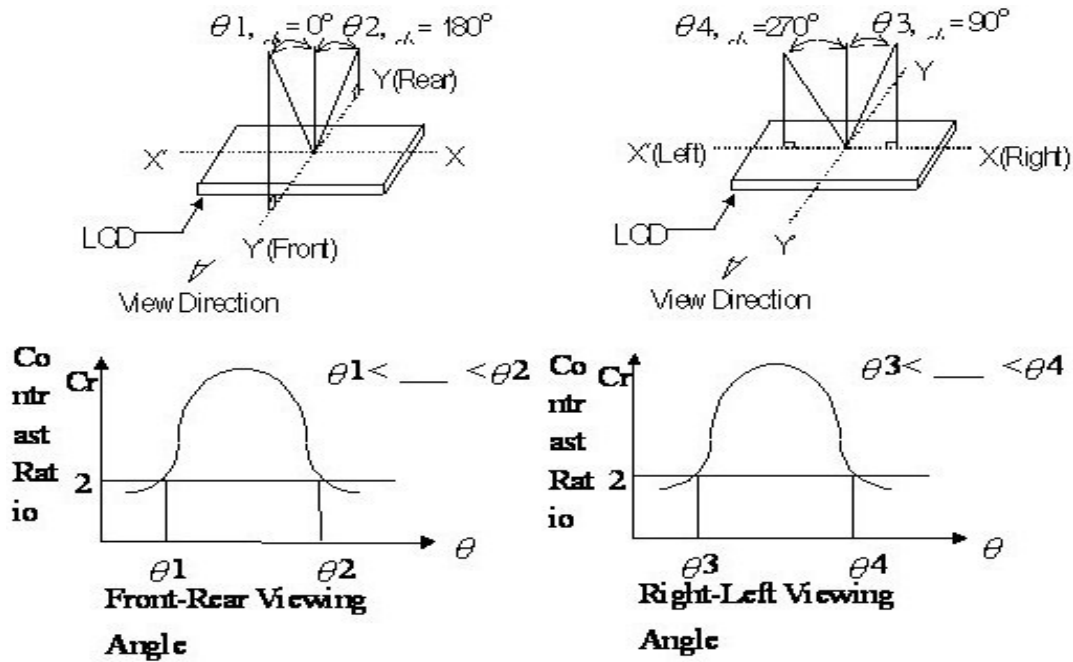

**14.2 Definition of Contrast**

$$C.R = \frac{\text{Brightness of nonselected segment (E2)}}{\text{Brightness of selected segment}}$$

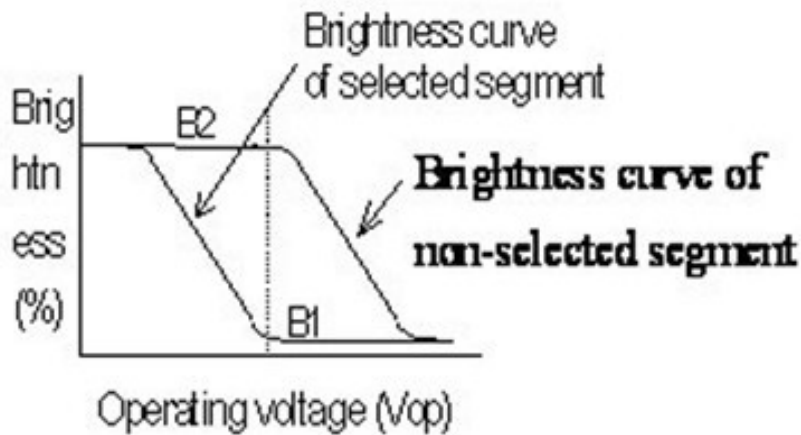

**14.3 Definition of Response**

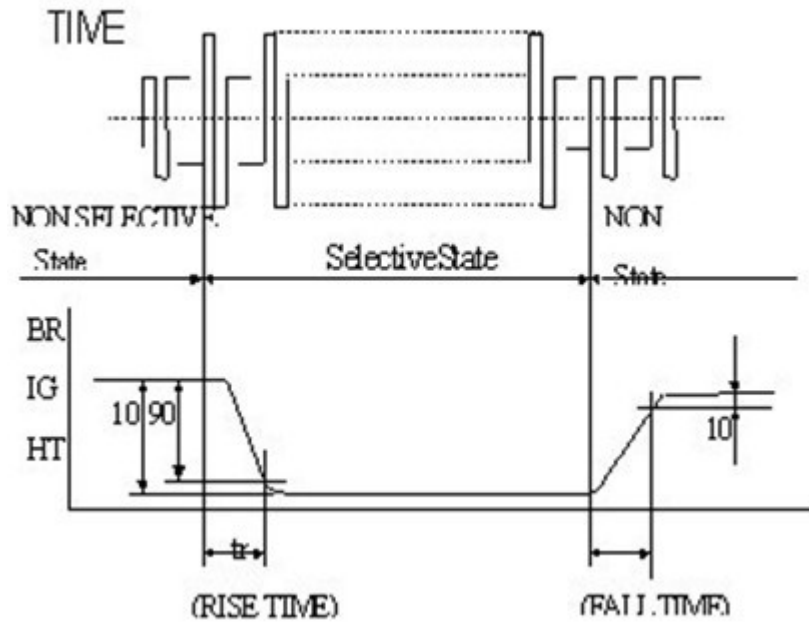

**14.4 Measuring Instruments For Elector-optical Characteristics**

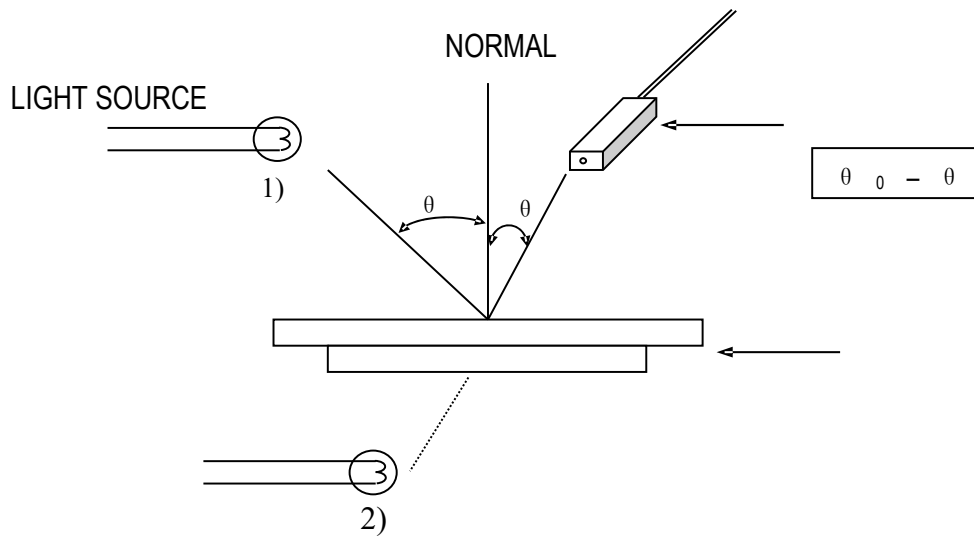

**\* Note:**

- 1) Light source position for measuring the reflective type of LCD panel;
- 2) Light source position for measuring the transfective / transmissive types of LCD panel.

**15. RELIABILITY TEST**

Operating life time: Longer than 75,000 hours  
 (at room temperature without direct irradiation of sunlight)

Reliability characteristics shall meet following requirements.

No.	Test Item	Content of Test	Test Condition
1	High Temperature Storage	Endurance test applying the high temperature for a long time storage	+80°C 96H
2	Low Temperature Storage	Endurance test applying the low temperature for a long time storage	-30°C 96H
3	High Temperature Operation	Endurance test applying the electric stress (voltage & current) and the thermal stress to the element for a long time	+70°C 96H
4	Low Temperature Operation	Endurance test applying the electric stress under low temperature for a long time	-20°C 96H
5	High Temperature/ Humidity Storage	Endurance test applying the high temperature and humidity storage for a long time	40°C 90%RH 96H
6	Temperature Cycle	Endurance test applying the low and high temperature cycle $  \begin{array}{ccccccc}  -20^{\circ}\text{C} & \longleftrightarrow & 25^{\circ}\text{C} & \longleftrightarrow & 70^{\circ}\text{C} & \longleftrightarrow & 25^{\circ}\text{C} \\  30\text{min} & & 5\text{min} & & 30\text{min} & & 5\text{min} \\  \longleftarrow & & & & & & \longrightarrow \\  & & & & & & 1 \text{ cycle}  \end{array}  $	-20°C/70°C 5 cycles
7	Vibration Test (Package State)	Endurance test applying the vibration during transportation	10Hz - 55Hz, 50m/s, 15min
8	Shock Test (Package State)	Endurance test applying the shock during transportation	Half-sinewave, 100m/s, 11ms
9	Atmospheric Pressure Test	Endurance test applying the atmospheric pressure during transportation by air	40 kPa 16 H



**16. Inspection specification**

**16.1 Visual Inspection**

- 1) Inspect under 2x20W or 40W fluorescent lamp (approximately 3000 lux) leaving 25 to 30 cm between the module and the lamp and 30 cm between the module and the eye (measuring position).
- 2) Appearance is inspected at the best contrast voltage (best contrast is adjusted considering clearness and crosstalk on screen).
- 3) Inspect the module at 45° right and left, top and bottom.
- 4) Use the optimum viewing angle during the contrast inspection.

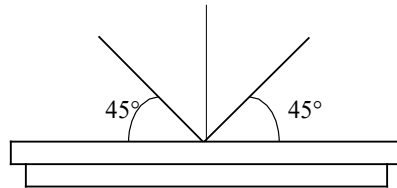

**16.2 Standard of Appearance Inspection**

No.	Item	Criteria																																			
1	Black spot White spot Dust	<p>Round type: as per following drawing</p> <p><math>= (X+Y)/2</math></p> <table border="1"> <thead> <tr> <th colspan="3">Acceptable quantity</th> </tr> <tr> <th>Size</th> <th>Zone A</th> <th>Zone B</th> </tr> </thead> <tbody> <tr> <td><math>\Phi &lt; 0.1</math></td> <td>Any number</td> <td rowspan="4">Any number</td> </tr> <tr> <td><math>0.1 &lt; \Phi &lt; 0.2</math></td> <td>2</td> </tr> <tr> <td><math>0.2 &lt; \Phi &lt; 0.25</math></td> <td>1</td> </tr> <tr> <td><math>0.25 &lt; \Phi</math></td> <td>0</td> </tr> </tbody> </table> <p>Line type: as per following drawing</p> <table border="1"> <thead> <tr> <th colspan="4">Acceptable quantity</th> </tr> <tr> <th>Length</th> <th>Width</th> <th>Zone A</th> <th>Zone B</th> </tr> </thead> <tbody> <tr> <td>—</td> <td><math>W \leq 0.02</math></td> <td>Any number</td> <td rowspan="4">Any number</td> </tr> <tr> <td><math>L \leq 3.0</math></td> <td><math>0.02 &lt; W \leq 0.03</math></td> <td rowspan="2">2</td> </tr> <tr> <td><math>L \leq 2.5</math></td> <td><math>0.03 &lt; W \leq 0.05</math></td> </tr> <tr> <td>—</td> <td><math>0.05 &lt; W</math></td> <td>As round type</td> </tr> </tbody> </table> <p>Total acceptable quantity: 3</p>	Acceptable quantity			Size	Zone A	Zone B	$\Phi < 0.1$	Any number	Any number	$0.1 < \Phi < 0.2$	2	$0.2 < \Phi < 0.25$	1	$0.25 < \Phi$	0	Acceptable quantity				Length	Width	Zone A	Zone B	—	$W \leq 0.02$	Any number	Any number	$L \leq 3.0$	$0.02 < W \leq 0.03$	2	$L \leq 2.5$	$0.03 < W \leq 0.05$	—	$0.05 < W$	As round type
		Acceptable quantity																																			
		Size	Zone A	Zone B																																	
		$\Phi < 0.1$	Any number	Any number																																	
$0.1 < \Phi < 0.2$	2																																				
$0.2 < \Phi < 0.25$	1																																				
$0.25 < \Phi$	0																																				
Acceptable quantity																																					
Length	Width	Zone A	Zone B																																		
—	$W \leq 0.02$	Any number	Any number																																		
$L \leq 3.0$	$0.02 < W \leq 0.03$	2																																			
$L \leq 2.5$	$0.03 < W \leq 0.05$																																				
—	$0.05 < W$	As round type																																			
2	Polariser scratch	Scratch on protective film is permitted Scratch on polariser: same as No. 1																																			
3	Polariser bubble	$\Phi = (X+Y)/2$																																			

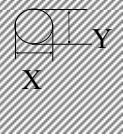
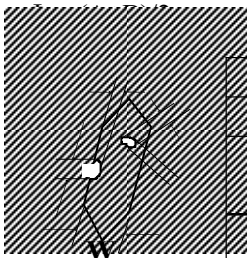
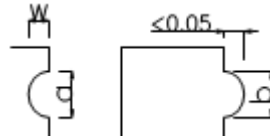
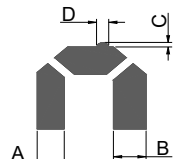
		 <table border="1" data-bbox="766 235 1428 548"> <thead> <tr> <th colspan="3">Acceptable quantity</th> </tr> <tr> <th>Size</th> <th>Zone A</th> <th>Zone B</th> </tr> </thead> <tbody> <tr> <td><math>\Phi &lt; 0.2</math></td> <td>Any number</td> <td rowspan="4">Any number</td> </tr> <tr> <td><math>0.2 &lt; \Phi &lt; 0.5</math></td> <td>2</td> </tr> <tr> <td><math>0.5 &lt; \Phi &lt; 1.0</math></td> <td>1</td> </tr> <tr> <td><math>1.0 &lt; \Phi</math></td> <td>0</td> </tr> </tbody> </table> <p>Total acceptable quantity: 3</p>	Acceptable quantity			Size	Zone A	Zone B	$\Phi < 0.2$	Any number	Any number	$0.2 < \Phi < 0.5$	2	$0.5 < \Phi < 1.0$	1	$1.0 < \Phi$	0									
Acceptable quantity																										
Size	Zone A	Zone B																								
$\Phi < 0.2$	Any number	Any number																								
$0.2 < \Phi < 0.5$	2																									
$0.5 < \Phi < 1.0$	1																									
$1.0 < \Phi$	0																									
4	Segment deformation	<p>4.1 Pin hole on segmented display W: segment width</p>  <table border="1" data-bbox="837 784 1428 1019"> <thead> <tr> <th colspan="2">Acceptable quantity</th> </tr> <tr> <th>Width</th> <th>Quantity</th> </tr> </thead> <tbody> <tr> <td><math>W \leq 0.4</math></td> <td><math>\Phi \leq 0.2</math> and <math>\Phi \leq 1/2W</math></td> </tr> <tr> <td><math>W &gt; 0.4</math></td> <td><math>\Phi \leq 0.25</math> and <math>\Phi \leq 1/3W</math></td> </tr> </tbody> </table> <p>Total acceptable quantity: 1 defect per segment Pin holes with <math>\Phi</math> under 0.10 mm are acceptable</p> <p>4.2 Pin hole on dot matrix display</p>  <table border="1" data-bbox="981 1209 1428 1444"> <thead> <tr> <th colspan="2">Acceptable quantity</th> </tr> <tr> <th>Size</th> <th>Quantity</th> </tr> </thead> <tbody> <tr> <td><math>a, b &lt; 0.1</math></td> <td>Any number</td> </tr> <tr> <td><math>(a+b)/2 \leq 0.1</math></td> <td>Any number</td> </tr> <tr> <td><math>0.5 &lt; \Phi &lt; 1.0</math></td> <td>3</td> </tr> </tbody> </table> <p>Total acceptable quantity: 7</p> <p>4.3 Segments / dots with different width</p>  <table border="1" data-bbox="981 1612 1332 1736"> <thead> <tr> <th colspan="2">Acceptable</th> </tr> </thead> <tbody> <tr> <td><math>a \geq b</math></td> <td><math>a/b \leq 4/3</math></td> </tr> <tr> <td><math>a &lt; b</math></td> <td><math>a/b &gt; 4/3</math></td> </tr> </tbody> </table> <p>4.4 Alignment layer defect <math>\Phi = (A+B)/2</math></p>	Acceptable quantity		Width	Quantity	$W \leq 0.4$	$\Phi \leq 0.2$ and $\Phi \leq 1/2W$	$W > 0.4$	$\Phi \leq 0.25$ and $\Phi \leq 1/3W$	Acceptable quantity		Size	Quantity	$a, b < 0.1$	Any number	$(a+b)/2 \leq 0.1$	Any number	$0.5 < \Phi < 1.0$	3	Acceptable		$a \geq b$	$a/b \leq 4/3$	$a < b$	$a/b > 4/3$
Acceptable quantity																										
Width	Quantity																									
$W \leq 0.4$	$\Phi \leq 0.2$ and $\Phi \leq 1/2W$																									
$W > 0.4$	$\Phi \leq 0.25$ and $\Phi \leq 1/3W$																									
Acceptable quantity																										
Size	Quantity																									
$a, b < 0.1$	Any number																									
$(a+b)/2 \leq 0.1$	Any number																									
$0.5 < \Phi < 1.0$	3																									
Acceptable																										
$a \geq b$	$a/b \leq 4/3$																									
$a < b$	$a/b > 4/3$																									

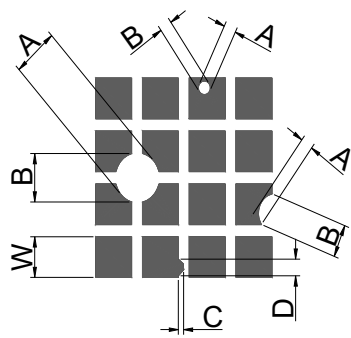
		 <table border="1" data-bbox="989 257 1428 604"> <thead> <tr> <th colspan="2">Acceptable quantity</th> </tr> <tr> <th>Size</th> <th></th> </tr> </thead> <tbody> <tr> <td><math>\Phi \leq 0.4</math></td> <td>Any number</td> </tr> <tr> <td><math>0.4 &lt; \Phi \leq 1.0</math></td> <td>5</td> </tr> <tr> <td><math>1.0 &lt; \Phi \leq 1.5</math></td> <td>3</td> </tr> <tr> <td><math>1.5 &lt; \Phi \leq 2.0</math></td> <td>2</td> </tr> </tbody> </table> <p>Total acceptable quantity: 7</p>	Acceptable quantity		Size		$\Phi \leq 0.4$	Any number	$0.4 < \Phi \leq 1.0$	5	$1.0 < \Phi \leq 1.5$	3	$1.5 < \Phi \leq 2.0$	2				
Acceptable quantity																		
Size																		
$\Phi \leq 0.4$	Any number																	
$0.4 < \Phi \leq 1.0$	5																	
$1.0 < \Phi \leq 1.5$	3																	
$1.5 < \Phi \leq 2.0$	2																	
5	Colour uniformity	Level of sample for approval set as limit sample																
6	Backlight	The backlight colour should correspond to the product specification Flashing and or unlit backlight is not allowed Dust larger than 0.25 mm is not allowed																
7	COB	Exposed wire bond pad is not allowed Insufficient covering with resin is not allowed (wire bond line exposed) Dust or bubble on the resin are not allowed																
8	PCB	No unmelted solder paste should be present on PCB Cold solder joints, missing solder connections, or oxidation are not allowed No residue or solder balls on PCB are allowed Short circuits on components are not allowed																
9	Tray particles	<table border="1" data-bbox="670 1176 1324 1411"> <thead> <tr> <th colspan="3">Acceptable quantity</th> </tr> <tr> <th></th> <th>Size</th> <th>Quantity</th> </tr> </thead> <tbody> <tr> <td rowspan="2">On tray</td> <td><math>\Phi &lt; 0.2</math></td> <td>Any number</td> </tr> <tr> <td><math>\Phi &gt; 0.25</math></td> <td>4</td> </tr> <tr> <td rowspan="2">On display</td> <td><math>\Phi \geq 0.25</math></td> <td>2</td> </tr> <tr> <td><math>L = 3</math></td> <td>1</td> </tr> </tbody> </table>	Acceptable quantity				Size	Quantity	On tray	$\Phi < 0.2$	Any number	$\Phi > 0.25$	4	On display	$\Phi \geq 0.25$	2	$L = 3$	1
Acceptable quantity																		
	Size	Quantity																
On tray	$\Phi < 0.2$	Any number																
	$\Phi > 0.25$	4																
On display	$\Phi \geq 0.25$	2																
	$L = 3$	1																

**17. LCD MODULES HANDLING PRECAUTIONS**

- Please remove the protection foil of polarizer before using.
- The display panel is made of glass. Do not subject it to a mechanical shock by dropping it from a high place, etc.
- If the display panel is damaged and the liquid crystal substance inside it leaks out, do not get any in your mouth. If the substance come into contact with your skin or clothes promptly wash it off using soap and water.
- Do not apply excessive force to the display surface or the adjoining areas since this may cause the color tone to vary.
- The polarizer covering the display surface of the LCD module is soft and easily scratched. Handle this polarize carefully.
- To prevent destruction of the elements by static electricity, be careful to maintain an optimum work environment.
  - Be sure to ground the body when handling the LCD module.
  - Tools required for assembly, such as soldering irons, must be properly grounded.
  - To reduce the amount of static electricity generated, do not conduct assembly and other work under dry conditions.
  - The LCD module is coated with a film to protect the display surface. Exercise care when peeling off this protective film since static electricity may be generated.
- Storage precautions  
When storing the LCD modules, avoid exposure to direct sunlight or to the light of fluorescent lamps. Keep the modules in bags designed to prevent static electricity charging under low temperature / normal humidity conditions (avoid high temperature / high humidity and low temperatures below 0 °C). Whenever possible, the LCD modules should be stored in the same conditions in which they were shipped from our company.

**18. OTHERS**

- Liquid crystals solidify at low temperature (below the storage temperature range) leading to defective orientation of liquid crystal or the generation of air bubbles (black or white). Air bubbles may also be generated if the module is subjected to a strong shock at a low temperature.
- If the LCD modules have been operating for a long time showing the same display patterns may remain on the screen as ghost images and a slight contrast irregularity may also appear. Abnormal operating status can be resumed to be normal condition by suspending use for some time. It should be noted that this phenomena does not adversely affect performance reliability.
- To minimize the performance degradation of the LCD modules resulting from caused by static electricity, etc. exercise care to avoid holding the following sections when handling the modules:
  - Exposed area of the printed circuit board
  - Terminal electrode sections